

USAID Transform WASH

Financial Management Training Manual



For WASH Projects

Year 2018



USAID
FROM THE AMERICAN PEOPLE



Table of Contents

Copyright and Publisher	iv
Abbreviations	v
1. The Introduction	1
1.1. One WASH National Program (OWNP) overview	1
1.2. Roles and Responsibilities of GOE and Development partners joining CWA	3
1.3. Program Manuals.....	4
2. Institutional Arrangements	5
Table 1: structural arrangements of the National WaSH Program	5
3. Financial Management Arrangements	7
3.1. Introduction to Financial Management for WASH	7
3.2. Overview of planning, budget process and budgetary control	8
3.2.1. Annual WaSH Plan	8
3.2.2. Budget Preparation and Approval	9
Table 2: OWNP Planning and budgeting calendar	10
3.2.3. Budget revision.....	13
3.2.4. Budget control/tracking.....	13
3.3. Fund flow and disbursement arrangements	16
3.3.5. Fund flow arrangements	16
3.3.6. Disbursement arrangements	18
3.4. Accounting and recording procedures.....	19
3.4.1. Accounting Policies and Procedures	19
3.4.2. Accounting System	20
3.4.3. Transaction Sources, Source documents, Books and Ledgers	20
Table 3: OWNP Source document, transactions and registration.....	20
Table 4: Transaction Register / Book of Original Entry	21
Table 4: General Ledger	22
3.4.4. Chart of Accounts	22
3.4.5. Community contribution	23
3.5. Internal controls.....	23
3.5.6. Cash receipt and payment.....	23
3.5.7. Payroll.....	29
3.5.8. Special payments – Travel, Per diem, Purchase advance and workshops	30
3.5.9. Fixed assets and stock management.....	32
3.6. Hand over procedures	33
3.7. Yearend Procedures	35
Table 6: Closing Procedures.....	35
3.8. Financial reporting.....	41

3.8.10. Introduction	41
3.8.11. Reporting Procedures	41
3.8.12. Periodicity of Reporting	42
Table 7: Financial reports procedures losing	43
3.9. Auditing	46
3.9.13. Internal Audit	46
3.9.14. External Audit	46
3.10. Organizational Structure	48
Table 8: Staffing Requirements	49
3.11. Salary Scale.....	50
3.12. Personnel Management.....	50
3.13. Per diems	51
3.14. Taxation	51
4. Annexes	52
4.1. Annex 1: Auditor Terms of Reference	52
4.2. Annex 2: Ineligible Expenses	59

Copyright and Publisher

USAID TRANSFORM WASH sets out to improve water, sanitation and hygiene (WASH) outcomes in Ethiopia by increasing access to and sustained use of a wide spectrum of affordable WASH products and services, with a substantial focus on sanitation.

It does so by transforming the market for low-cost quality WASH products and services: stimulating demand at community level, strengthening supply chains and building the enabling environment for a vibrant private market.

USAID TRANSFORM WASH is a USAID-funded project implemented by PSI in collaboration with SNV, Plan International, and IRC. The consortium are working closely with government agencies - including the Ministry of Health, the National WASH Coordination Office and regional governments.

© 20YY, USAID WASH Transform

Permission is hereby granted for sharing and adaptation of this material, in whole or in part, for non-commercial use, educational, scientific or development-related purposes, provided that the appropriate and full citation is given.

Cite this publication as follows: Tegenu Tadesse Procurement and Contract Management Consultant, 2018. Financial Management Training Manual. Addis Ababa: USAID Transform WASH.



Abbreviations

AWP	Annual Work Plan
BPV	Bank Payment Voucher
BoFED	Bureau of Finance & Economic Development
CRV	Cash received Voucher
CMP	Community Managed Project
CPV	Cash Payment Voucher
COWASH	Community-Led Accelerated Water, Sanitation and Hygiene Project
CSOs	Civil Society Organizations
CWA	Consolidated WASH Account
FGE	Federal Government of Ethiopia
FM	Financial Management
GTP	Growth and Transformation Plan
HEW	Health Extension Worker
H&S	Hygiene & Sanitation
IFR	Interim Financial Report
IDA	International Development Association
IBEX	Integrated Budget and Expenditure
IFAC	International Financial Accountant Committee
JV	Journal Voucher
M&E	Monitoring & Evaluation
MoE	Ministry of Education
MoFEC	Ministry of Finance & Economic Cooperation
MoH	Ministry of Health
MoU	Memorandum of Understanding
MoWIE	Ministry of Water, Irrigation and Electricity

NGO	Non-Governmental Organization
NWCO	National WaSH Coordination Office
NWSC	National WaSH Steering Committee
OD	Operational Directive
ODF	Open Defecation Free
OP	Operational Policy
OWNP	One WASH National Program
OWRP	One WaSH Regional Program
PFS	Project/Program Financial Statement
PMU	Program Management Unit
POM	Program Operational Manual
PPA	Public Procurement Agency
R-WaSH	Rural Water, Sanitation & Hygiene
RWCO	Regional WASH Coordination Office
RWMC	Regional WASH Management Committee
RWSC	Regional WaSH Steering Committee
WWTT	Regional WaSH Technical Team
T/CWB	Town/City Water Board
T/CWSC	Town/City WASH Steering Committee
T/CWTT	Town/City WASH Technical Team
ToFED	Town of Finance and Economic Development
UAP	Universal Access Plan
U-WaSH	Urban Water, Sanitation & Hygiene
WaSH	Water, Sanitation & Hygiene
WASHCO	WASH Committee (community level)
WDC	Woreda Development Committee
WCBU	WASH Capacity Building Unit
WIF	WASH Implementation Framework

WMP	Woreda Managed Project
WoFED	Woreda Finance and Economic Development Office
WPMU	One-WaSH Program Management Unit
WSA	Woreda Support Agent
WSC/WSG	Woreda WaSH Consultants
WSSU	Water Supply & Sewerage Utility
WWT	Woreda WASH Team
ZoFED	Zone of Finance and Economic Development

1. The Introduction

1.1. One WASH National Program (OWNP) overview

- 1. The One WASH National Program (OWNP)** - is the Government of Ethiopia's (GoE) main instrument for achieving the goals set out for WASH in the Growth and Transformation Plan (GTP). The program was designed to be implemented in two Phases. Phase I is covering the period from July 2013 to June 2015 and Phase II from July 2015 to June 2020.
- 2. The Program's Development objective** is to improve the health and well-being of communities in rural and urban areas in an equitable and sustainable manner by increasing access to water supply and sanitation and adoption of good hygiene practices. The core guiding principles that is governing implementation of OOWNP are summarized as below:
- 3. OOWNP Approach** - The OOWNP follows the modalities of the Sector-Wide Approach (SWAP) because it allows enhancement of development impact by scaling up, building stronger donor partnerships in support of country-led sector reform Programs, and improving the performance of institutions in managing all sector resources. The government coordinates the participation of these donors and the involvement of other stakeholders through the OOWNP. To this effect the Federal Government of Ethiopia has designed National WASH program based on a Memorandum of Understanding (MoU) signed by the Federal Ministries of Water, Irrigation & Electricity; Health; Education and Finance & Economic Cooperation. Four of the significant features of the WASH program as per the National WASH Implementation Framework include; Integration, Harmonization, Alignment and Partnership which are summarized below
 - Integration: This principle aims at integrating safe water use with good sanitation and hygiene practices at the household level, in schools and health facilities (Institutional WaSH) through synergy built among the four sectoral offices: water, health, education and finance. This includes coordinated and collaborative planning, implementation, monitoring, reporting and evaluation of program results;*
 - Alignment: The main goal of this principle is to ensure that OOWNP will align with the policies, priorities, strategies and plans of the pertinent Ministries, Sectoral Development Plans and with the administrative systems, standards and procedures of the Federal and Regional Governments of Ethiopia. The principle also ensures that WASH is recognized and affirmed as an integral, ongoing component of the Government's broader developmental program and WASH responsibilities are incorporated in the established process streams and mandates of the four sector agencies' staff at all levels. The other goal is an internal alignment of structures and procedures within government, both vertically (i.e. from federal to Kebele level) and horizontally (i.e. across the different subsectors which comprise WASH);*

- *Harmonization*: This principle leads to One WaSH Plan, One WaSH Budget, One WASH Report; implying to OWNPN. Harmonization also assumes that One Consolidated WASH Account (CWA) will be opened where all Development Partners contributions are deposited from which WASH activities and investments would be supported. However at this stage of OWNPN, not all partners are joining CWA but for those partners who desire to join CWA an account which is managed by MoFEC is opened. Use of ear marked account will continue in the meantime for those DPs who are expected to join CWA at a later stage'
- *Partnership*: The OWNPN recognizes Civil Society Organizations (CSOs) and the Private Sector as significant partners playing an essential part in attaining OWNPN target along with the four sector Ministries and Development Partners. This leads to strong commitment to engage more the Civil Society Organizations (CSOs) and the Private Sectors

4. Program Components - The OWNPN advocates for one plan, one budget, one reporting system and one Consolidated WASH Account (CWA). To realize GoE's desire and preparation to move towards programmatic approach AfDB, DFID, IDA and UNICEF have agreed to pool their resource in to a Consolidated WaSH Account to finance part of the One WASH National program. The OWNPN financed under CWA has three components as detailed here below:

- i. *Rural WASH* - Support through financing rehabilitation of existing and construction of new conventional community water points and water supply schemes, technical support of self-supply, supporting sanitation activities including improvement of household and institutional hygiene and sanitation
- ii. *Urban WaSH* – This component finances study and design, capacity building and management support, environmental and resettlement safeguards, immediate service improvement and expansion of water supplies. Sanitation and urban environment improvement include procurement of equipment, construction facilities, latrine sludge/septage treatment plant and public toilets; and developments of wastewater management system in selected location
- iii. *Program Management and Capacity Building* - This component includes support to improve skills and capacity of the program implementing agencies at all levels to plan, manage and monitor program activities through training, post-construction management support, equipment and tools provision, and monitoring and reporting support. This component also supports minimum staffing and resource requirements necessary to effectively implement the Program at all levels.

5. Program Eligible expenditures that the OWNPN finances through the CWA are payments made in accordance with the provisions of agreement terms and applicable guidelines, rules and regulations for planned expenditures in respect of the above components & categories of expenditures. Eligible expenditures do not include payments for goods and services that are included in negative list of development partners contributing to the CWA that all DPs contributing to the program agree to.

Details of the negative lists will on an ongoing basis be provided to the implementing agencies by all CWA contributing DPs in advance

1.2. Roles and Responsibilities of GOE and Development partners joining CWA

- 6. Responsibilities of GOE** - The GOE will exert the maximum efforts to facilitate the successful implementation of the OWNPN, and will hereunder:
- a) Have sole responsibility for the planning, administration, financial management, accountability, risk management and implementation of the OWNPN, covering all the OWNPN activities;
 - b) Establish a foreign currency account at the National Bank into which the Development Partners disburse resources from which the funds are transferred to the Consolidated WaSH Account (CWA) for onward release to accounts designated in the OWNPN;
 - c) Develop annual plans for the allocation of funds based on clear and transparent need based planning criteria that prioritize areas of greatest need;
 - d) Be responsible for ensuring, demonstrating, reporting that international best practices, as agreed between the signatories are adhered to when planning and providing water services in areas of resettlement and in the community development program;
 - e) Follow up with MOFEC and ensure that all implementing agencies open special accounts for the OWNPN and are kept in accordance with procedures set forth in the financial management policies and guidelines of the GOE;
 - f) Timely submit the quarterly or biannual progress reports, including the outstanding balance that is how much of DP's contribution is left in the CWA and in the accounts of the implementing agencies at the end of the reporting period;
 - g) Provide sufficiently qualified personnel, do its utmost to ensure the allocation and timely release of its contribution for the successful implementation of the OWNPN; and ensure sufficient internal audit capacity in the implementing agencies and MOFEC to enable the timely submission of internal audit reports to the external auditors;
 - h) Promptly inform the Development Partners of any condition that interferes or threatens to interfere the successful implementation of the OWNPN and of any major policy or financial decision; and call for a meeting to consult with the Development Partners on remedial actions to be taken; and
 - i) Undertake timely annual external financial and procurement audits of the CWA (paid from the CWA) and share reports, the management letters and plan of actions on the audit recommendations within 6 months from the end of the fiscal year.
- 7. Responsibilities of Development partners** - Each of the CWA contributing Development Partners establishes individual arrangement compatible with the spirit and provisions of the OWNPN POM and refrains as far as possible, from setting conditions in the bilateral arrangements that contradict or diverge from the spirit of the POM. In case of any inconsistency or contradiction between the provisions and conditions of the POM and any of the bilateral arrangements, the provisions of the bilateral arrangements will prevail.

- a) The Development Partners base their actual support on the progress attained in the implementation of the OWNP. Progress will be measured through the commonly agreed key performance indicators (KPIs)¹ and reporting as described in this manual;
- b) The Development Partners ensure timely release of their commitments to the CWA in accordance with the bilateral arrangements and this manual;
- c) Each year, CWA contributors jointly review CWA financed OWNP performance, implementation of audit recommendation action plan, and the physical and financial plan for the next fiscal year , including the draft procurement plan, and again commit their contributions for the fiscal year as per the plans prepared by the WaSH sector Ministries and endorsed by the Chair of the National Steering Committee(NSC);
- d) CWA contributors cooperate and communicate with each other fully and in a timely manner on all matters relevant to the implementation of the CWA financed OWNP;
- e) CWA contributors share all information on aid flows, technical reports and any other documentations/initiatives related to the implementation of CWA financed OWNP and relevant to the support; and
- f) Development Partners do not bear any responsibility and/or liability to any third party with regard to the implementation of the CWA financed OWNP.

1.3. Program Manuals







- 8. **Program Operational Manual (POM)** is developed to serve as a guiding document for GoE and Development partners who have pooled /would be pooling their resources into a Consolidated WaSH Account (CWA) for the implementation of the OWNP. The POM provides common and practical planning, implementation, administration and operational guidance in the management of CWA financiers. All pooling partners and GoE has reviewed and formally endorsed the POM. As per the POM, the World Bank is designated to regularly monitor implementation of the pool fund to ensure its adherence to the fiduciary and safeguard policies and procedures.
- 9. **Financial management Manual** was also prepared and endorsed. The FM manual is designed to allow the establishment of a uniform system across the implementing agencies, to provide Financial Management Guidelines and procedures that will specify how financial transactions of the program are recorded and reported by implementing agencies at Federal, Regional, and Towns/Woreda levels, from the initial identification of transactions to the final financial reporting.

¹ KPI targets for the CWA under each component will be proportionally apportioned from the OWNP targets based on the contribution of the CWA compared to the total estimated cost of the OWNP for each component.

2. Institutional Arrangements

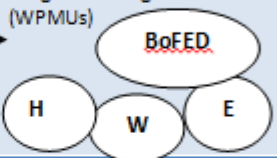
10. **Structural arrangement-** Steering committees, Technical teams, Program Management Units and Program coordination offices are established at different level of government and jurisdictions as can be seen in table 1 below.

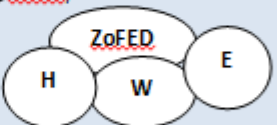
Table 1: structural arrangements of the National WaSH Program

Level	Governance & Guidance	Oversight & Management	Program Implementation	Program Coordination
Federal	National WaSH Steering Committee	National WaSH Technical Team	Federal Sectors' WaSH Program Management Units (WPMUs) 	National WaSH Coordination Office 
Regional	Regional WaSH Steering Committee	Regional WaSH Technical Team	Regional Sectors' WaSH Program Management Units (WPMUs) 	Regional WaSH Coordination Office 
Special Zones (or others Zones where applicable)	Zonal WaSH Management Team	Zonal WaSH Technical Team	Zonal WaSH Program Management Units – (Water, Health, Education, and ZoFED) 	Zonal WaSH Coordination Office 
Woreda	Woreda WaSH Steering Committee (Woreda Cabinet)		Woreda WaSH Team 	
Town/City	Town/City WaSH Steering Committee (Town Cabinet)		Town/City WaSH Technical Team Municipality Health Desk Education Desk Town Water Board Town Water Utility	

11. Program Operational Manual and the memorandum of understanding of the program intensively discuss the institutional arrangement. Issues applicable to financial management are briefly incorporate Institutional arrangements for the flow of Program funds from the federal level down to the Woreda level.

12. **At the Federal level**, MoFEC will be responsible for the overall financial management of the project. This includes but not limited to the management of the designated and the pooled Birr account, the transferring funds to BoFED and other federal level

implementing entities, the responsibility for producing regular financial reports and facilitating the annual audit of the project account. It will ensure that acceptable financial management systems are in place and are well documented in FM manuals. It will also be responsible for oversight and coordination of the project. It will also be responsible for the funds transferred to it. Federal level implementing entities like MoWIE, WRDF (either through MoWIE or on its own), MoE, MoH, and others will be responsible for the funds transferred to them from the MoFEC and will report on fund utilization to MoFEC.

13. **At the regional level**, BoFEDs will be responsible for the management of the funds transferred to them for implementation. They are responsible for ensuring that acceptable accounting system, covering both regional and Woreda levels are maintained. They will review and supervise the effective use of accounting procedures by Woredas and other implementing entities at regional level, and provide technical support and assistance to them. They will transfer funds to woredas, and other regional, zonal level implementing entities and follow up on advances and accountability of these advances. They will collect and aggregate all financial data and information from implementing entities and Woredas on the Project and report to MoFEC. Regional level implementing entities like BoE, BoH and others will be responsible for the funds transferred to them from the BoFED and will report on fund utilization to BoFED.
14. **At the Woreda level**, WoFED, are responsible for the funds transferred to them and for the financial management aspects of the project. As WoFED is the last accounting center in the GoE PFM, it manages resources of sector offices under pool arrangement. The records of funds utilized will be maintained in accordance with sound accounting practices that are capable of generating accurate and timely information for verification. Among the various FM roles and responsibilities, WoFEDs ensures, as a minimum that (i) support in budget preparation and follow up on budget execution as per approved plans and activities; (ii) undertakes timely payments for eligible expenditures for the smooth implementation; (iii) exercises necessary fiduciary controls and; (iv) prepare and submits timely reports on fund utilization to Region (BoFED).

3. Financial Management Arrangements

3.1. Introduction to Financial Management for WASH

15. Financial Management Policies and Procedures: In line with the principle of alignment with Government systems, the OWNPN will follow GoE's financial management rules and policies. MoFEC will be responsible for the overall financial management of the Program and will carry out financial management in accordance with sound financial management procedures including internal control mechanisms in line with GoE's financial management policies and guidelines. In addition, a separate financial management manual was prepared for the Program to depict the different set of activities required at all level to manage the WASH-II program finance.
16. It is envisaged that ONE WaSH Program will follow the modalities of the Sector-Wide Approach (SWAP) because it allows enhancement of development impact by scaling up, building stronger donor partnerships in support of country-led sector reform Programs, and improving the performance of institutions in managing all sector resources. The SWAP approach also presents particular opportunities and challenges for the harmonization of procedures by participating donors and more effective pooling of resources.
17. The FM system under SWAP typically requires the production of timely, understandable, relevant, and reliable financial information that allows DPs, the government, and other stakeholders to plan budget and implement the Program, monitor compliance with agreed procedures, and appraise progress toward its objectives. To meet these requirements, the system will have the following features:
 - *Budgeting.* A system to identify the short-term activities necessary to achieve the Program objectives and express these activities in financial terms.
 - *Accounting.* A system to record, analyses and summarize financial transactions.
 - *Funds flow arrangements.* Appropriate arrangements to receive funds from all sources and disburse the funds to the agencies involved in Program implementation.
 - *Internal control.* Arrangements, including internal audit, to provide reasonable assurance that (a) operations are being conducted effectively and efficiently and in accordance with relevant financing agreements; (b) financial and operational reporting are reliable; (c) applicable laws and regulations are being complied with; and (d) assets and records are safeguarded.
 - *Reporting.* A system that would produce sufficient detailed information to manage the Program, and provide each donor with regular consolidated interim financial reports and annual consolidated financial statements.
 - *External audit.* Arrangements for conducting annual external audit of the consolidated financial statements for the sector on terms of reference acceptable to all the stakeholders.

- *Financial management staffing.* Relevantly qualified financial management staff, including accounting and internal audit staff, with clearly defined roles and responsibilities to conduct financial management activities.

3.2. Overview of planning, budget process and budgetary control

3.2.1. Annual WaSH Plan

18. Annual WaSH Plans show how the broader objectives, priorities and targets of the Strategic Plans are translated into practical activities and detailed budgets. Annual WaSH Plans are operational. Developing annual plans requires consultation at every level with major stakeholders including relevant government institutions, Development Partners, NGOs and, at the woreda and Kebele levels, with the community.

19. WaSH annual planning is done in two stages:

- Core Planning** (August through November) establishes annual targets/outputs and CWA plus budget ceilings;
- Annual Work Planning** (December through February) adds the specifics - activities, assignments, schedules and proposed expenditures from all sources.

20. WaSH implementing agencies draft Core Plans (physical and financial) using a common format provided by the National WaSH Coordination Office (NWCO). When approved, the Core Plans serve as the basis for building detailed **Annual WaSH Work Plans** – again, using a common format. Approved WaSH AWP are subsequently built into the Development Plans at each administrative level.

21. One WaSH Plan means that all major contributors (government, Development Partners, NGOs and communities) agree to be a part of a single comprehensive national WaSH program. The One Plan is built out of Strategic Plans and Annual Plans that are developed at each level and are linked to one another. It also means that all major WaSH activities of all implementing agencies, at each level, are included in **one composite plan**. The Consolidated WaSH Account Plan which is built by the woreda, regional and federal WaSH structures is central to the Composite WaSH Plans. As NGOs are part of the composite plan, they are responsible to share information on the resource that they are allocating for various activities in the sector. However they are not expected to contribute to the CWA.

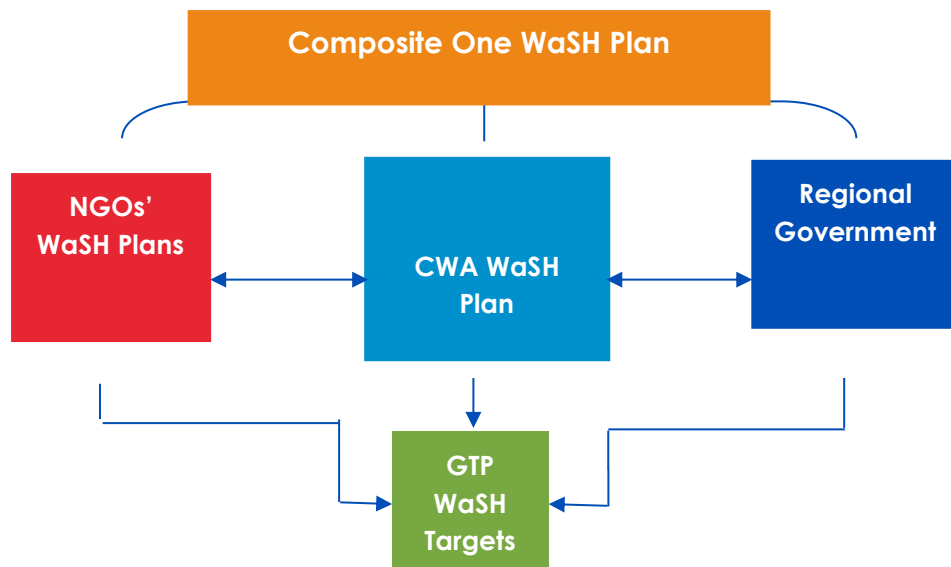

22. **Strategic Plans** have time frame in line with the period of the national development plan of the country and include goals, targets, strategies, resources and key activities. **Annual Plans** have a one-year time frame that translate the priorities of the Strategic Plan into a set of practical activities, detailed schedules, budgets and specific outputs or results directly relating to GTP targets. The Annual Plan is *operational*.
23. Both Strategic and Annual Plans are: **Linked** to resource mapping (of all anticipated financial and human resources); **Linked** to other plans (strategic-to-annual & from one level-to-next level); **Approved** - by the relevant federal/local government authority; **Comprehensive** – covering all WaSH activities of all implementers; and **Consistent** - with the Strategic Planning & Management approach.

3.2.2. Budget Preparation and Approval

24. **Budget preparation and approval** - The One-WaSH Program Budgeting takes place based on forms and procedures designed by MoFEC. Sector Ministries and Regional sector bureaus are responsible for preparation and requesting WaSH budget. It is based on a comprehensive resource mapping of all resources available to WaSH at the given level, i.e. federal, regional, zonal or woreda/town. The basis for annual WaSH budgets is based on approved annual plans, prepared at each level according to a common planning format provided by the NWCO. WaSH budget preparation will follow the government budget preparation schedule. The budget approval process for WaSH budget will also follow existing government regulations and procedures.
25. **Budget Calendar:** The OOWNP planning cycle follows the Ethiopian Government Financial Year which begins in July and ends in June. Planning occurs before the new Financial Year in order to release funds in early July. Specific dates for key stages of the planning and budgeting process are given in **table 2** below. These dates must be followed accurately and have no flexibility. It is the responsibility of managers at each level to ensure this is the case. Failure to meet the deadline risks delaying funds arrival.

Table 2: OWNP Planning and budgeting calendar

JULY
DEVELOPMENT PARTNERS CONFIRM CONTRIBUTION FOR FOLLOWING FISCAL YEAR
AUGUST
<ul style="list-style-type: none"> • <i>NWCO&WMUs complete national Resource Mapping and propose national CWA+ budget ceiling and GTP targets for the Regions</i> • <i>FWTT reviews – recommends to NWSC – NWSC approves</i> • <i>NWCO notifies Regions of national CWA+ budget ceilings and GTP targets</i> • <i>RWCO&WPMUs complete regional Resource Mapping</i> • <i>RWCO&WPMUs propose notional CWA+ budget ceiling and GTP targets for Towns, Special Zones and Woredas</i> • <i>RWSC endorses proposed ceilings & targets and RWCO notifies Towns, Special Zones and Woredas</i>
SEPTEMBER
<p>Towns, Special Zones &Woredas:</p> <ul style="list-style-type: none"> • <i>review anticipated resources and set priorities and interact with communities/kebeles re: potential programming</i> • <i>estimate feasible physical and financial level of activity, investments, and outputs and draft Core Plans</i> • <i>forward draft Core Plans to respective Development Committees for review and initial approval</i>
OCTOBER
<ul style="list-style-type: none"> • <i>Towns, Special Zones &Woredas forward draft Core Plans to RWCO for review and consolidation</i> • <i>RWCO consolidates Core Plans from Towns, Special Zones &Woredas and drafts Regional AWP</i> • <i>RWSC endorses draft plan and forwards to BoFEDs for initial approval and to NWCO for review and consolidation</i>

NOVEMBER

- *NWCO consolidates Regional Core Plans and completes National Core Plan*
- *NWCO submits draft national Core Plan to FWTT for review and forwarding to NWSC*
- *NWSC & Development Partners review draft National Core Plan – NWSC approves*

DECEMBER

- *NWCO notifies all levels that National Core Plan is approved.*
- *Woreda/Towns/Special Zones fine tune AWP*s
- *Woreda/Towns/Special Zones forward AWP*s to WoFED (ZoFED) for information and to RWCO for review and consolidation

JANUARY

- *RWCO consolidates AWP from woredas & special zones – drafts Regional AWP for RWSC endorsement*
- *RWSC endorses and forwards to BoFEDs for information and to NWCO for review and consolidation*
- *NWCO consolidates Regional AWP*s and drafts National AWP – forwards to FWTT

FEBRUARY

February 8th: NOTIFICATION OF ANNUAL SUBSIDY BUDGET & ISSUE OF BUDGET CALL

- *NWTT reviews draft national AWP and recommends to NWSC*
- *NWSC & Development Partners consult – and NWSC endorses composite Annual WaSH Plan and submit to MoFEC for review and approval*
- *NWCO notifies Regions/Woredas/Towns of the endorsement of the composite Annual WaSH Plan*
- *Regions/Woredas/Towns submit composite Annual WaSH Plans to respective Councils for inclusion in Annual Development Plans*

MARCH

March 22nd: DEADLINE FOR PUBLIC BODIES TO SUBMIT BUDGET REQUESTS

26. Budget Procedures For One-WaSH:

- Funds supporting WaSH activities come from the Federal government of Ethiopia, external financing Agencies (investors/Development Partners), non-government organizations and participating communities.
- WaSH budget preparation will follow the government budget preparation schedule. The budget approval process for WaSH budget will also follow existing government regulation while the Development Partners component is budgeted at federal level the government contribution will be budgeted at respective institutional levels of government.
- Regional budget process will also follow the same process. RWCO will prepare regional WaSH plan based on special zone, woreda and town WaSH plans and regional sector bureaus plans. Based on the annual WaSH plan prepared by RWCO, regional sector bureaus will submit annual WaSH budget to BoFED.
- The budget process at Woreda level will be prepared by WoFED based on the annual WaSH plan of WWT and earmarked budget from Development Partners and woreda allocation and will be submitted for approval to the woreda council
- At federal level, the NWSC will approve national WaSH plan based on regional WaSH plan consistent with house of federation budget formulas, and federal sector ministries plans and also determine the development partners' contribution for the national WaSH intervention for the fiscal year. Consequently, federal ministries will request annual budget/resource based on the annual WaSH plan agreed and approved by NWSC. The annual WaSH budget aggregated to the federal ministries will be submitted to MOFEC and the budget will be approved by appropriate authorities in accordance with the countries laws and regulations.
- The CWA budget for ONE-WaSH (including the regional budget) shall be proclaimed at the federal level under in the name of the three WaSH sector Ministries, disaggregated by regions and components under each entities. Once identified and used, the budget code for ONE-WaSH shall remain unchanged throughout the Program life.
- The annual CWA budget for ONE-WaSH will be included in the Federal Government's annual budget for each fiscal year.
- The Budget Proclamations would list the ONE-WaSH budget as a special purpose grant as distinguished from the general block grant – so that these funds can only be used for purpose ONE-WaSH
- ONE-WaSH funds would be passed on from MOFEC to Regions and from Regions to Woredas as a non-offsetting grant (to ensure that these are treated as additional resources).
- In order to achieve targets set out in the ONE-WaSH Program Appraisal Document, it will be necessary for ONE-WaSH to identify and cost the inputs required to achieve deliverables. Some of the inputs will recur every year, and should be

categorized according to the Program document. The Category includes: Goods; Works; Consultancy Services; Non-consulting service; Training & workshop and; Operating Costs including M&E and capacity building;

3.2.3. Budget revision

27. Revision to an agreed and approved plan and budget should not be easily allowed. Neither will inter- component budget transfer be permitted in the program (unless the project is formally restructured by the GoE with the agreement of the World Bank). However; there could be good causes to consider changes and budget transfers among activities in a given component. It is therefore essential that there should be procedures to govern such changes.
28. When such a change is considered absolutely essential, the revision of work plan and budget together with procurement and training changes that may be required need to be recommended by the Woreda cabinet to the regional technical and steering committees for submission to the federal level technical and steering committees through NWCO for approval.
29. Such revisions at sub-national levels will generally be allowed only once in a fiscal year. The region has the right to reject the proposition from a Woreda without consultation with the appropriate federal level authority. Budget transfer application for approval is accepted only if the proposal is submitted within the first two quarters of a fiscal year.
30. The plan & Budget including a consistent Procurement Plan should be cleared by the Bank before commencement of any disbursement.

3.2.4. Budget control/tracking

31. The purpose of budget control is to ensure: Expenditures are incurred only if there is an available budget and also Actual expenditures does not exceed budgeted expenditure.
32. The budget should pass through different ladder for approval. Moreover, there might be additions and reductions to the already approved budget, on due courses of operations. The control process should ensure records are updated for all variables affecting the balance of the budgets. Budget control is achieved through a combination of commitment accounting and expenditure approvals. All engaged in the budget execution process are responsible for ensuring that all spending are in accordance with the budget.
33. Provision is made in the WaSH structure for each of the governmental Implementing Agencies to have their own accounting staff to administer WaSH funds on a permanent and/or contractual basis at MoFEC and BoFED level. MoFEC, BoFED, ZoFED and WoFED are responsible for financial reporting using IBEX system; the WASH structures will be primarily responsible for monitoring WASH implementation and provision of guidance to implementers.
34. MoFEC, BoFEDs, ZoFEDs and WoFEDs are responsible for recording, maintaining and controlling WaSH budgets at the federal, regional, zonal and woreda levels

respectively. MoFEC ensures that sufficiently trained personnel are in place to handle the financial management requirements at each level.

35. Implementing entities receiving resources are also responsible for budget discipline and control to insure that activities are primarily budgeted and expended as well as reported.
36. Budget control is exercised to ensure that WaSH funds are being spent as planned with respect to categories, cost, timeliness and value for money. Primary responsibility for budget control in WaSH is with the WaSH accountants. However, managers at each implementing entity receiving resources at each level (WWTs, RWTTs and the NWTT including the Woreda Sector Offices, Regional WaSH Sector Bureaus and the Federal WaSH Sector Offices and etc) will review on a monthly basis the financial reports prepared by the accountants and take whatever action may be required to ensure effective budget control. The main tools will be budget codes, ledger cards, and budget tracking.
37. Budgetary control consists of (a) establishment of budgets for each functional responsibility, identifying income to be achieved and expenditure to be incurred in order to meet the agreed objectives of ONE- WaSH, (b) continuous comparison of actual with budgeted results, and (c) action resulting from this comparison, either to ensure adherence to the defined objectives or to agree on some modification of the original plan.
38. The budget control helps to ensure that: expenditure is committed or incurred only if there is an available budget, and actual expenditure does not exceed budgeted expenditure. The main tools for budget control will be budget codes, ledger cards, and budget tracking.
39. The annual budget should be broken up into quarterly budget to facilitate preparation of quarterly Interim Financial Report (IFR). The finance unit in each of the implementing agencies receiving funds for program implementation will be responsible for preparing monthly budgetary control statements comparing actual with budgeted results and ensuring that explanations are obtained from the responsible officer on the variances. Heads of the respective agencies are responsible for examining the control statements and providing appropriate remedial action.
40. To sum up budget control will be at: (a) transaction level where accountants check for availability of budget before payment is approved- this is at the payment process and it is here that chart of accounts mapped to budgets help to identify activities (b) at system level – when recorded in the accounting system (IBEX or manual) or off the system there should be continuous checking of budget and actual (budget codes, budget cards and commitment controls are part of this) and finally (c) through Reports to internal and external stakeholders (IFRs, management reports, reports to users) all should be able to report on budget utilization including variances and analysis of variance and explanations there of which should be leading to actions to take mid-way correction to the budget or performance or both.
 - *Budget codes - In the government accounting system, the coding system starts from budgeting. In the process of budget preparation, all the recipients of the*

fund from MoFEC are identified with specific budget code. That code is basic to understand how much budget is allocated to a public body for the budget year. Transfer to the public body shall be made under the code identified in the budget proclamation and the recipient of the budget is responsible to account for the budget it has received. The institution code for budget and the expenditure shall be the same for a recipient. Using that code, it is possible to produce a report for the transfer, expenditures and the fund balance of a recipient

- *Budget/Expenditure Subsidiary Ledger Cards* - This serve two purposes: (i) Maintains the adjusted budget and commitments against the budget, and (ii) Maintains a record of total expenditure by item of expenditure for each Budgetary Institutions by source
 - *Additions/Reductions to the Approved Budget* - During the year, the approved budget may be revised in two ways: (i) Budget supplement. A budget supplement is an additional appropriated budget; and (ii) Budget transfers, when the addition is made to the budget of one Public Agency and the reduction is made to the budget of another Public Agency, and changes, when transfers of budgeted expenditure are made from one item of expenditure to another within the same Budgetary Institution.
 - *Adjusted Budget* - The adjusted budget means the appropriated budget adjusted for additions to and/or reductions from the appropriated budget. The adjusted budget is the benchmark for budget control, as an item of expenditure must not exceed its adjusted budget
 - *Commitments* - A commitment is a way of marking off part of the budget that has not yet been spent but that is obligated for a specified expenditure. A Budgetary Institution may enter into contracts or issue purchase orders. These obligations to spend money are commitments, that is, before the good or service is ordered and before the payment is actually made, the amount of the purchase order is subtracted from the BI's approved budget. A commitment is a tool that prevents overspending by identifying amount committed to pay for items that have been requested but not yet ordered and to determine the budget that is available for expenditure. The commitment Balance is updated by adjustment to show budget that is not committed. Occasionally, a commitment may be cancelled/revised. In such cases, the change should be recorded in the budget expenditure subsidiary ledger card to amend the commitment and the uncommitted balance.
- *Transaction level* - Every payment should be approved by the accountants before any kind of payment is effected by the account section. The accountants should only approve expenditure if payment request does not exceed the appropriate budget

- *Reports – (i) The accountants of the program shall extract the approved revised budget for each item of expenditure from the budget ledger card. Expenditure to date is also extracted from the same ledger and put in the budget tracking report. Comparison is made between the two and a third column showing the budget balance. The budget balance shall be normal, under spent or over spent; (ii) The accountant shall give comments on the budget balance in bullet points to give warnings to the budget users; (iii) The accountant shall agree the report by signing on the face of it. The report shall then be circulated to the procurement officer, the section that follows up the program and the head of the implementing agency on the basis of which they can take appropriate corrective action.*
- *In regions, BoFEDs are responsible for the financial management function. The preparation of budget tracking report is therefore the responsibility of BoFEDs. The circulation of the report will be to the above-identified three officers of the implementing agencies.*

3.3. Fund flow and disbursement arrangements

3.3.5. Fund flow arrangements

41. WaSH resources will flow to federal and regional beneficiaries through the existing government fund flow arrangement. Under this arrangement, each administrative level, the specialized Finance bodies, control the release of funds and report upwards on their utilization.
42. The Ministry of Water Irrigation and Electricity, and implementing agencies have a special role in approving and supervising the Program budget, the disbursement and accounting functions remain with MoFEC and the BoFEDs. Funds will move from the CWA Accounts and will be forwarded to the beneficiaries/implementing agencies, based on the approved budget and agreed disbursement plan.
43. As part of OWNP preparation, the Government and participating Donors would agree on the CWA program to be undertaken, separately identifying activities to be financed by the Government and DPs as per annual work plans and budgets. Each quarterly Interim unaudited financial report will show the relative financing of the expenditures by CWA contributing partners. By approving the reports, the WB and DPs are approving the proportion of expenditures to be financed as well as the proportions future advance (i.e. the allocations to donors of both the expenditure and future fund request). The fund flow arrangements would typically work as follows:
 - *Separate foreign currency Designated Account managed by MoFEC at the National Bank of Ethiopia on terms and conditions acceptable to IDA is opened to receive resources from IDA. Similarly for each DP, separate designated account managed by MoFEC at the National Bank of Ethiopia is opened to receive resources from each DP*
 - *Other Disbursement mechanisms will also be applicable (i.e. direct payment, Reimbursement and Special Commitment)*

- Resources will also be transferred from the designated accounts to **pooled** CWA Birr Account managed by MoFEC. It is important to maintain subsidiary ledger for fund transferred to the CWA to identify the DP whose fund deposited or disbursed into the CWA
- MoFEC transfer funds to regions (BoFED) and to Federal Sector ministries (MoWIE, MoE, MoH), according to agreed budgets, procurement plans, and work plans for CWA as well as the rate of utilization
- BoFED transfer resources to Woredas/WoFED, Zones, Towns and BoWE, BoE, BoH
- The fund flow to each implementing entity will be according to Annual work plan and budget
- Disbursement to designated account is on the basis of quarterly IFRs, disbursement proportion agreed among CWA partners and bilateral agreement with CWA contributing partners
- Indicative Financing shares of partners for the annual work plan and budget will be communicated during/prior to the preparation of the plans. However, definitive financing proportions will be determined based on IFRs on the basis of various parameters. Approval of IFRs means that the proportion of financing as indicated in the IFR has also been approved.
- For fiduciary and safeguard procedures: (i) WB procurement guidelines shall apply (e.g. for procurement of all contracts procured through ICB2 and consultancy contracts to be financed from pooled funds in which the WB is a contributor, the WB would conduct the prior reviews on behalf of Partners that are contributing to the CWA). (ii) With regard to financial management, the Bank reviews and clear all audits, IFRs, and ToR for audit firms and (iii) with regard to safeguards, the WB's safeguard policies shall apply and Bank to lead the monitoring of the compliance to the agreed instruments

44. Fund flow arrangements for consolidated WaSH Account is depicted below:

² Most of the contracts are expected to fall under NCB which follows government procurement procedures.

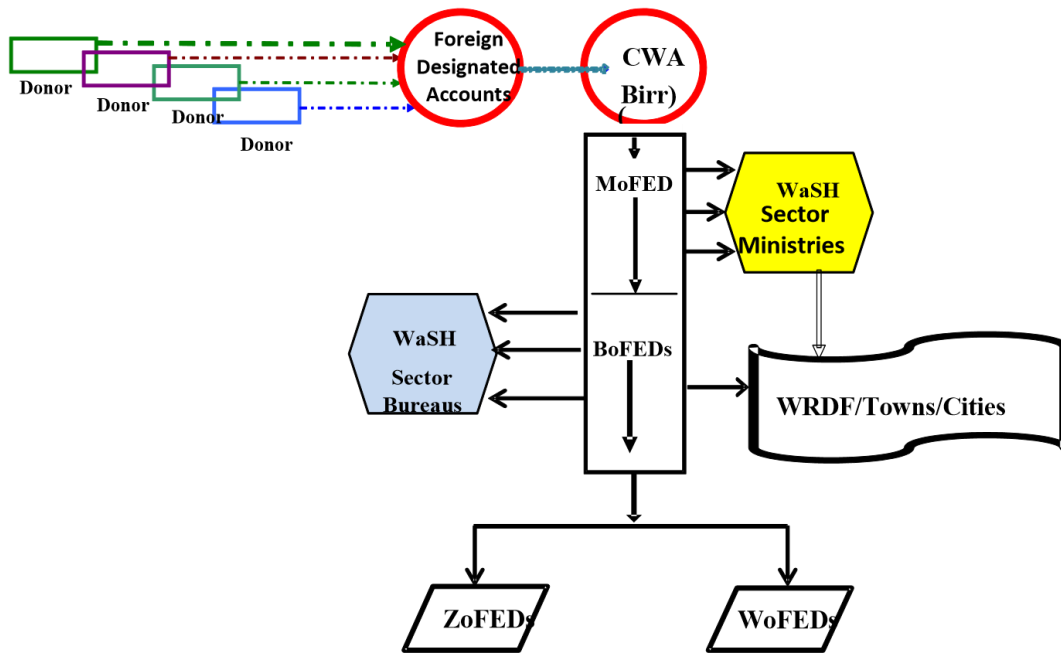

3.3.6. Disbursement arrangements

45. Consolidated WaSH Account

- i. The Development Partners' initial deposits in to the program, specifically, to their respective the program Foreign Currency Designated Accounts with National Bank of Ethiopia constituted their advances to the Program. The amount of initial advance from each CWA partners is based on the proportion of their contribution to the overall CWA budget
- ii. Subsequent disbursement from CWA contributors will be deposited to the designated account based on the quarterly IFRs reviewed and approved by the WB on behalf of CWA pooling partners and/or the bilateral agreements DPs may contribute to the review of IFRs
- iii. While WB reviewing the IFRs , it will also evaluate the expenditure forecast for the next quarters to determine the amount of subsequent disbursement from each CWA partners
- iv. Upon receipt of replenishment from the Development Partners MoFEC transfers funds to the Implementing Agencies from Pooled Birr account as per their cash flow plans, work plans, utilization rates, etc converting contributions into Birr from the Designated Accounts and transferring it to the pooled Birr Account (Consolidated WaSH Account) managed by MoFEC. As stated above, MoFEC disburses funds to each implementing entity according to their respective annual work plan and budget as well as other factors like size of resources at hand, utilization rates, etc. Actual transfers will be made based on performance and in this case least and poorly performing regions will face loss of their share and best performers will have chance of getting more funds unutilized by poor performers

- v. As Disbursement to the designated account will be on the basis of report (IFR), the reports will include gross forecasts for 6 months and deducting ending balances will effectively avail a net resource sufficient to cover one quarter need
- vi. On the basis of Q-1 IFR, MoFEC after 60 days of end of the quarter will forecast a gross requirement for 6 months (Q2 and Q3) and will deduct ending balances at Q1 to arrive at a net requirement. If the ending balance position exceeds the funds required for the fund request period, no transfer of fund need to be made from the Development Partners. The replenishment request for the period has to take into consideration the outstanding balance at the end of the reporting period. The WB (including interested DPs) will review the realism and soundness of the expenditure forecast against the procurement and physical plan, procurement processes and actual need for cash requirement of the program

46. Implementing Agencies' accounts

- i. MoFEC's (and BoFEDs') disbursement of funds to the WaSH governmental implementing agencies follows the same pattern
- ii. Each implementing agency of the program is required to open a separate local Currency Account for the program. Initially, each implementing agency received a 1st quarter and 2nd quarter advance based on its approved Annual Work Plan and Budget. At the end of 1st quarter the agency prepared a report on expenditures together with, and a request for, replenishment to cover the amount budgeted for the 3rd quarter less the amount of unexpended funds from the 1st quarter. This "roll over" system means that implementing agencies always have in hand their budget for the upcoming two quarter
- iii. Request/reports are vetted and approved at a higher level in each instance and consolidated into the Quarterly Report and Request for Replenishment presented by MoFEC to the Development Partners
- iv. Funds allocated for WMP are transferred to the Woreda WaSH Fund and replenished quarterly as outlined above
- v. Woredas selected to receive CWA funds will be agreed jointly by Government and CWA contributing partners during the Annual Planning Workshop
- vi. CWA partners should agree the number of woredas and criteria for selecting woredas/towns to be covered. Selecting the specific woredas/towns is left for the regions and local governments as long it satisfies the criteria and the number

3.4. Accounting and recording procedures

3.4.1. Accounting Policies and Procedures

47. The accounting system at the Federal, Regional and Woreda level employs a modified cash basis of accounting. Project specific FM manual has been developed for the program. The FM manual, in line with the requirement of the government manual, requires application of double entry accounting on modified cash basis of accounting.

3.4.2. Accounting System

48. The Financial Manual is designed to use manual recording system as an interim arrangement and assumes computerization will be applied.

49. The OWNP FM manual indicated that a standalone IBEX system will be developed; all the necessary procedures issued and training to the program personnel will be conducted. However, currently uniform accounting system are not being used. Implementing entities are using either IBEX, Peachtree or Manual.

3.4.3. Transaction Sources, Source documents, Books and Ledgers

50. The accounting and financial management cycle of the FGE and therefore the OWNP passes the following process:

- Budgeting expenditure
- Preparation and coding of source documents or vouchers then
- Journalizing entries to the transaction register,
- Posting to control and subsidiary ledgers and finally
- Preparation of financial statements and other reports

51. Therefore, the bookkeeping cycle for WaSH starts when money is received in the special accounts and ends when report of expenditures is presented to the MoFEC and MoFEC is closing the accounts.

52. Summarized and tabulated below are the specific source documents and books of the account together with the required financial reports, as per the FGE manual.

Table 3: OWNP Source document, transactions and registration

Transactions and Source Documents	Book of Original Entry	Books of Final Entry	Financial Reports
Cash Receipt Voucher(CRV)			
Bank payment voucher (BPV)			
Petty Cash Payment voucher (CPV)	Transaction Register	General Ledger Subsidiary Ledger	

Journal voucher		Budget Expenditure Ledger Cards	Expense
Debit notes			
Credit notes			
Purchase Documents			
Payroll			

53. Source Documents - Source documents are prepared to capture transactions as and when it occurs.

54. Transaction Register / Book of Original Entry - The Transaction Register is maintained to ensure that all transactions are recorded in the accounting system and serves as a basis to post entries into the Ledgers. Journal entries are coded on each source documents. Each of the transactions and its reference are first recorded in the Transaction Register from the respective source documents.

55. All transactions of WaSH concluded by the implementing agency shall be recorded in the register from the source documents. There are three major types of transactions to be recorded in the Transaction Register as shown on the below table.

Table 4: Transaction Register / Book of Original Entry

Source documents	Types of transaction	Specifics
CRV	Cash receipts	Involves Collection of cash Receipt of check through Bank transfers
Cash or Bank Payment voucher	Cash payment	Involves Cash payment Payment in check Transfer by Bank
Journal Voucher	None cash transactions, transfers & Aid in kind	Transactions not involving Cash receipts and payment vouchers

56. Each implementing agency shall maintain the standard transactions register. The register should be prepared in duplicate.
57. At Federal level, MoFEC shall also maintain transaction registers in addition to the standard register to deal with the special/designated bank accounts. One transaction register per special account shall be maintained. These transaction registers will be different from the local currency register in that they have additional column to fill in the foreign currency information.
58. General Ledger - General ledger is a group of accounts that is used as a second step in the process of recording and summarizing transactions. The primary book of record is the transaction register and the general ledger is the second register. It is between the register and the financial reports and as such prepares information that goes into the reports. The ledger card shall be used without any modification in the form.
59. The WaSH General Ledger is organized in sequence of the account codes as follows, alike the Government account:

Table 4: General Ledger

Revenue	1000
Assistance	2000
Loan accounts	3000
Asset accounts	4100
Liability accounts	5000 to 5499
Net Asset/Equity account	5601
Expenditure accounts	6000 series

60. The balances of the General ledger would be the basis for financial reporting as proved by periodic trail balance.
61. Subsidiary Ledger - Control account balances may need detail in some cases. Subsidiary ledgers shall be maintained to provide that additional detail information. Accounts that needs subsidiary ledger are the expenditure, receivable, inter implementing agencies accounts and payable.

3.4.4. Chart of Accounts

62. The FGE accounting system provides a Chart of Accounts, which is a system of coding government uses, to identify and classify financial entities and events.

63. OWNP chart of account is strictly prepared as per the Government accounts and considering the practice of the Federal, regional and Woreda accountant. It should be noted that separate ledger (group of account) should be maintained by every implementing entity for each component/sub component of expenditures in line with the budget and government chart of account code until a standalone IBEX system which incorporate component & sub-component of expenditures will be developed.

3.4.5. Community contribution

64. Community groups make an important contribution to the development of the country. Involving people in OWNP is central to the Program's overall vision. In doing so, many of these groups work in some form of partnership with the Program. Community could contribute to the program in cash and/or in Non-monetary means. Non-monetary contributions could include in-kind and voluntary support for a project other than cash. Generally, non-monetary contributions include either voluntary labour or donated (sometimes at cost) goods and materials. Contribution of voluntary labor may include: demolition of existing facilities; site preparation; digging trenches for plumbing/wiring, general site clean-up; fit-out of new facilities; landscaping; painting.

65. In-kind contributions to program are considered as important as cash contributions because in-kind contributions when factored as part of a project budget gives the real total cost of a project and in-kind contributions are frequently the only contributions community can make to a project. Therefore, accurately valuing these contributions are very important in determining the real total contribution to a project.

66. **Calculating in-kind Contributions** - Valuation of in-kind contributions should be based on average commercial prices (norms) applicable in a country or a region. For the results to be accurate the grantee will have to find ways of estimating and documenting in-kind contributions as part of project preparation and project implementation.

67. **Accounting and reporting in kind contribution** - WaSH Sector ministries and the regional states received contribution in-kind shall record in monetary terms and quarterly report to their respective higher level entities following the reporting cycle of this manual. While the estimation of in-kind contribution is not captured during the annual plan exercise, as per the requirement of the annual budget Law, the ministry of finance shall consolidate and report as supplementary budget.

3.5. Internal controls

68. OWNP internal controls follow the government control procedures at the Federal, Regional and Woreda levels. In addition, the FM manual & the POM provide details of program specific controls, procedures and policies.

3.5.6. Cash receipt and payment

69. Internal Control over Cash Receipt

- *All cash receipt should be evidenced by Cash Receipt Voucher (CRV) as per format Annexed, in strict numerical sequence. The account code for receipt of funds shall be written on the face of the cash receipts;*
- *Cashier should have no role in the preparations of, or access to, the accounting records other than those related directly to cash. The cashiers' records should be subject to regular independent verification;*
- *Cheques received should be deposited on separate deposit slips made available from the banks, each deposit slip being referenced to the receipt to which it relates;*
- *The cashiers should use secured cash safes to keep money;*
- *The unused CRV pads must be kept in safe custody by a responsible official who is not involved in the handling of cash;*
- *Such documents must be issued to the cashier in strict numerical sequence and the number of pads in the hands of the cashiers restricted to their immediate requirements;*
- *New pads should only be issued against return of the completed ones, which should be carefully scrutinized by the issuing official for apparent correctness, i.e. there have been no alteration or erasures;*
- *Registers of unused receipts should be maintained by the custodian who should be subject to periodic surprise verification by accountant or auditor;*
- *The cashier's record should be in such a way that all receipts are recorded in numerical sequence so that any omission can easily be spotted;*
- *The deposit of each day collections should be recorded separately so that the resultant nil balance proves that all cash received has been deposited;*
- *The cashier's records should be independently checked every day and particular attention made to the integrity of the numerical sequences of the prime documents which should be carefully scrutinized for-evidence of alternation or erasure*

70. Distribution & Completion of Cash Receipt Voucher - The receipt Voucher is prepared in three copies and distributed as follows (i) Original to the payer as acknowledgment of the cash receipt; (ii) Second copy to the accounts; and (iii) Third copy is retained in the pad

71. Recording Cash Receipts - All entries in to the General Ledger are recorded from the coded Cash Receipt Vouchers. Source documents (e.g. Cash Receipt Vouchers), are prepared at the time of a transaction occurs to capture the transaction. Supporting documents are CRV, credit advice, deposit slips and other relevant documents as necessary.

72. *Calculating and Recording Foreign Currency Exchange Gains or Losses* - At the end of the reporting period, the Cash at Bank in Foreign Currency ledger contains an ending balance for cash in Birr of the Foreign Currency. However, the ending balance of the foreign currency account in Birr may not be equal to the Birr equivalent of ending foreign currency balance, using end of the reporting period exchange rates. The difference is attributable to changes in the exchange rate during the reporting period and represents an exchange gain or loss.
73. **Disbursements** - Payments may be effected in cash or through banks (in cheque or through bank transfer). Payment in cash may be effected from a petty cash fund, if it is below the banks' cheque payment threshold i.e., Birr 2000, or from cash drawn for various payments.
74. **Bank Payments** - The source documents to record cash paid by an accountant with cheques or bank transfer is the Bank /Cheque/ Payment Voucher. It is used to acknowledge and evidence the payment of Check or Bank Transfer and serve as source document to record the transaction in the accounting system. The Bank Payment Voucher is prepared in two copies and distributed as follows: (i) Original copy to the accountant to be attached with the evidence of the transaction that occurred; and (ii) Second copy is retained in the pad as a file copy.
75. Policies and Procedures for Bank/Cheque Payments - The following procedures should be strictly adhered in respect of cheque payments:
- *Separate designated bank accounts but one local currency account will be opened (which is the CWA). Separate bank account should also be opened by every implementing entity of the Project. Bank accounts are operated by the dual signatories from the respective assigned signatories. To minimize the risk of indispensability, more than two signatories may be delegated as additional signatories in the absence of primary signatories;*
 - *Bank transfers shall be made in written instructions to bank against approved Payment Request;*
 - *The Accountant prepares Bank Payment Voucher for payments made in cheque or Bank Transfer upon receipt of approved payment request. A requesting unit should fill out a Bank Payment Request Form and get the approval of the designated official – the PIU Coordinator;*
 - *All cheque payments shall be made via a Bank Payment Voucher and shall be duly authorized by the responsible officer;*
 - *All Bank payments should require dual signatories. The approval procedure and the authorization limits to approve Bank Payments shall be as per the delegation granted for approval by the steering committee.*
76. Internal Control Procedures for Bank Payments - The following internal control shall apply
- *Cheque books collected from bank by designated signatories or authorized personnel. The cheque leaves should be counted for completeness at the time*

of receipt. Any missing leaves are to be reported immediately to the bank for replacement;

- Only one cheque book at a time is supposed to be issued to the accountant responsible for cheque preparation;
- Cheque Payment Voucher is prepared based on the authorized payment requests. Availability of budget and completeness and validity of supporting documentation should be carried out before preparation and submission of the payment voucher and the cheques to the officials for signature;
- Blank cheques should not be signed by any of the signatories;
- Cheque stubs are to be completed with the date, name of payee, amount and initials of the authorized officials;
- When there is an error in the preparation of a cheque, the cheque is cancelled by writing "CANCELLED" diagonally across the face of the cheque. The cancelled cheque is then retained in the cheque book stapled to the cheque stub;
- Each cheque payment should be evidenced by cheque Payment Voucher. Payments to organizations, suppliers and contractors shall be supported with the required documents such as receipts, invoices, contracts, work completion certificates and goods or materials receipt reports;
- In order to ensure that only the designated beneficiary can receive payment and fraudulent endorsement is not possible, cheques should preferably be made payable to a person company or enterprise and crossed A/C Payee only;
- Bank accounts should be reconciled on a monthly basis against a bank book or cash at bank ledger;
- Supporting documents for bank payment should be stamped with a "Paid Stamp". Paid stamp should be prepared in the name of PROJECT COORDINATION UNIT Project and it should contain Reference and Date. See figure below:

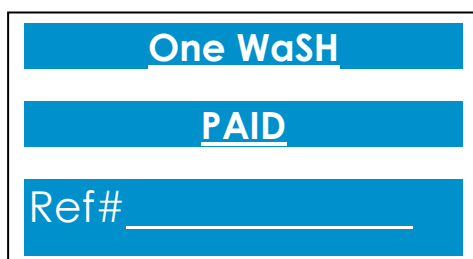

77. Petty Cash - Procedures for Maintaining Petty Cash Fund

- *Petty cash funds will be authorized and established, under the custody of a cashier, for those payments which are not expedient to be made by cheques. All small payments i.e., less than Birr 2000 shall be paid out of the petty cash;*
- *The Petty cash fund float size will initially be Birr 5,000.00; depending on the circumstances of implementing the project this amount could be revised to a higher one;*
- *Petty cash fund shall be replenished whenever the amount of the cash in safe reach a safety cash level (20%);*
- *Petty cash payments should be evidenced by Cash Payment Vouchers. Cash Payment Vouchers should be prepared against approved Request for Payment form;*
- *The cashier should maintain a Petty Cash Book;*
- *Surprise and periodic cash count should be made on petty cash fund by the head of finance unit or designated officers and counts should be evidenced by a cash count certificate;*
- *Proper cut-off procedures should be undertaken to ensure that all the source documents are accounted in the period they are applicable. As far as possible, no cash balance should be kept in the hands of cashiers at the end of the fiscal year. The counting team should sign at the back of the last voucher used for cash collection and for cash payments (CRV and CPV);*
- *Cashiers should deposit yearend cash on hand before the physical count commences and may withdraw (with approved payment procedures) in the following day (first day of the new fiscal year) if required.*

78. Maintaining Petty Cash Book - The purpose of the petty cash book is to control and monitor the movement of the petty cash fund. The source document to record the receipt of petty cash fund is a Bank Payment Voucher in which petty cash fund is established or replenished. The source document to record payment from petty cash fund is the Cash Payment Voucher. The payment vouchers are given to the accountant to reimburse the cashier with petty cash.

79. Internal Control over Petty Cash –

- *Conduct surprise cash count of petty cash; and evidence the count by a cash count certificate*
- *Ensure that a petty cash book is maintained, which shows the daily expenditures and the balance on hand;*
- *Use a pre-numbered petty cash voucher;*
- *Petty cashiers should not have role in signing cheques or approving payment vouchers or recording and/or posting functions;*

- *Check that daily cash on hand reports are delivered by the petty cash custodian to the senior finance officer;*
- *Supporting documents for petty cash payment should be stamped with a "Paid Stamp";*
- *Paid stamp should be prepared in the name of PROJECT COORDINATION UNIT. The stamp should contain reference number and date.*

80. Replenishment of Petty Cash Fund - To replenish to the extent of petty cash spent, the cashier surrenders all cash payments vouchers together with the attached supporting documents to the accountant after completing petty cash summary sheet.

81. Recording Petty Cash Fund - The PROJECT COORDINATION OFFICE/ UNIT authorizes the establishment of petty cash fund, and the entry based on the authorization letter and Bank payment voucher will be - The petty cash fund account will be debited and cash at bank will be credited for the amount of cash being replenished to the cashier. The replenishment is applied only to those payments evidenced with cash payment vouchers. The entry will be the same as the establishment but for the amount replenishment documents are submitted and BPV is prepared.

82. Recording of Cash Overage/Shortage

- *Cash Overage - The one who is in charge of counting (accountant/internal auditor) should ensure that the cashier prepares a cash receipt voucher for the extra money found during the surprise count to evidence the overage;*
- *Cash shortage - Based on the decision of management, the cash shortage balance could be deducted from the payroll of the cashier. Alternatively, management might require the cashier to settle the lost money in cash, in which case coding will be done on CRV*

83. Bank Reconciliation - From practice, it is understood that the balance per record of organization's book may not agree with the balance per bank statement. The most common causes for differences include: (i) Deposits in transit, not shown in the bank statements; (ii) Outstanding cheques not presented to the bank; (iii) Deposits/payment not recorded on books; (iv) Errors in recording either by the bank or by the implementing agency; and (v) Interests/bank charges not accounted by book.

84. Bank reconciliation should be prepared on a monthly basis in a week time from the end of the month concerned. Bank reconciliation should be made on a monthly basis even if there is no payment or deposit or transfer received during the month. The reconciliation will help us to correct book errors, and to identify bank errors and other fraudulent activities as early as possible before it is too late.

85. Documents required to prepare the bank reconciliation are (i) Monthly bank statements received from the bank; (ii) General ledger, and (iii) Bank reconciliation report of the previous month.

3.5.7. Payroll

86. Salaries are representing substantial amount expense paid in cash by the Program. Salaries for skilled and semi-skilled manpower-includes contract staffs of the project, and technical experts, whose monthly payment (payroll) is for tax deductions.

87. Internal control over payroll include:

- *Records relating to staff shall be based on proper documents issued by an authorized official. Input records like engagement letters, increments etc. should be properly completed and authorized;*
- *All changes made to earnings for individual staff members should be authorized and controlled;*
- *Only eligible employees should be paid and the amount drawn for payment shall be reconciled by comparing it to the previous month's payroll;*
- *Whenever it is feasible, especially when there are more than one accountant, the function of payroll preparation should be rotated among these accountants;*
- *Payroll deductions are authorized, correctly accounted for and paid to the appropriate third parties;*
- *Transactions related to salaries are accurately entered in the accounting record*

88. Personal Record

- *A Personnel record should be kept for each employee, containing particulars of such matters as engagement, retirement or dismissal, rates of pay, agreed deductions, specimen signature, photograph or other identification. Such documents should be kept separate from the accounts department;*
- *The staff involved in the preparation of the payroll being notified of engagements, transfers, discharges and changes in rates of pay on properly authorized forms;*
- *Entries in the personnel files should be authorized by someone not connected with the payroll preparation*

89. Review of Payrolls

- *Payroll sheets should be periodically reviewed and reconciled against official personnel records including employee's names, rates of pay, and deductions by an internal auditor and/or accountant who was not engaged in the preparation and effecting of payroll payments;*
- *Payroll totals shall be reconciled from month to month and any changes verified with authorized changes to the official records*

90. Payroll Payment

- *Payroll should be paid against approved payroll sheet;*
- *Only the net amount of cash required for payment of salaries shall be drawn from the bank;*
- *Unclaimed salaries should be recorded immediately after the conclusion of payment and only issued subsequent to satisfactory proof of entitlements. Salaries unclaimed after a certain period shall be deposited to the bank and cash receipt should be raised for them;*
- *Settlement of unclaimed salary - Based on approved payment requests of employees, a cheque will be prepared for the total of the claimed net pay of employee and payment would be effected accordingly.*

91. Payroll Deductions

- *Statutory deductions should be carefully computed and should be included in the payroll to arrive at the calculations of net pay. They are automatic and mandatory (e.g. income tax etc.);*
- *Payroll deductions; other than statutory deductions, should only be made in accordance with the employee's written approval maintained in his personnel record;*
- *All deductions should be credited to separate accounts to assist in ensuring control over and accuracy of payments to third parties*

3.5.8. Special payments – Travel, Per diem, Purchase advance and workshops

92. Travel and Per diem: Travels should basically be pre-planned. Per Diem rates and other reimbursable expenses are computed in accordance with the prevailing Government rates or approved rate for the project;

93. When Travel Advance is taken – When a travel advance is required, the traveler should fill the Travel Request and Approval Form, prepared in one copy and get the approval of his unit/department head. The traveler then passes the approved form to accounts for budget checking and processing payment. Earlier Travel advance must be cleared - (settled) before another travel advance is given. When Travel Advance Settled:

- *Traveler should settle the per diem advance in three days from the date of return;*
- *Traveler should complete and submits a Travel Report and Settlement Form within three days of returning from the travel. The settlement form has to be prepared by the traveler (finance may assist) in one copy, attaching allowable receipts for reimbursable expenses. The form has to be verified by head of the unit or department where the traveler belongs, checked by accountant and should be approved by the respective authority;*

- *The Financial Management Specialist has to check the validity of the supporting documents. Where any errors are found, the Travel Report and Settlement Form are returned to the traveler with a memo listing the errors;*
- *If there is additional payment to be given to the traveler, the appropriate payment voucher will be prepared. If the traveler is supposed to refund for the excess advance, he/she will be informed to return the cash against a cash receipt*

94. Purchase Advance

- *Purchase advance may be provided to a purchaser in cash or in cheque in a situation where vendors are not known in advance;*
- *The appropriate procurement documentations, including purchase requisition, purchase order, approved request for payment and others as applicable, need to be fulfilled before preparation of the payment voucher;*
- *Purchase advances should be settled in 30 days' time from the date of receipt;*
- *No purchase advance will be provided unless the purchaser settles the earlier advances;*
- *All purchase advances should be settled immediately up on receiving the goods/service by providing the required invoice, GRN, purchase order, and evaluation minutes and Performa invoices;*
- *All purchase advances should be settled before closing date of Sene 30 (July 7) of each budget year*

95. Workshops, Seminars and Training - Payments to workshop and seminar participants will be done according to the following procedure:

- *Attendance of all participants for each day has to be duly taken;*
- *The number of stay on travel has to be confirmed by the mode of transport they have used and distance of the place they are coming from to the venue;*
- *Confirmation letter of salary scale and that each participant has not taken any allowance from its work station has to be submitted;*
- *Official and original receipt for transport payment in its clean form has to be submitted as a witness for the expense incurred for transportation;*
- *All the above information may have to be attested by the focal person who organizes the event;*
- *Payment sheet would be prepared based on the above information and approved by the respective officials who are delegated to authorized payments*

96. Journal Voucher - Journal Vouchers shall be used to capture transactions that do not result in payment or receipt of cash and serve as a source document to record in the ledger. Journal Vouchers should be supported by the necessary supporting documentation to be valid. Journal Vouchers must be approved before posting it to the ledger.
97. Not all transactions involve payment of cash or receipt of cash. Transactions that do not involve the movement of cash are: (i) Some receivable and payable transactions; (ii) Payment made by the World Bank through Direct Payment or Special Commitment on behalf of the project. These are supported by debit/credit memos and statements; (iii) Correction of incorrect entries already recorded in the ledger. For example, a payment might have been debited to a wrong expenditure account and need correction; and (iv) Adjusting & Closing entries.
98. The Journal Voucher shall be prepared in two copies. The first copy is the accounts copy and the second copy is retained in the pad. The accountant should fill the following information on Journal Voucher.

3.5.9. Fixed assets and stock management

99. Fixed Assets - Similar to accounting of stock, the FGE accounting manual requires Fixed Assets ledger to be maintained under assets category. However it is observed that the tradition of expensing these items, as and when purchase, is continued for varieties of reasons. Those reasons might still have a weight to handle this account.
100. As per the definition from the Government Owned Fixed Asset Management Manual, "Fixed Assets – means tangible asset costing Birr 200 or more that is in operational use and has a useful economic life of more than one year. Fixed assets include the following among others. Furniture and fixtures, computers, heavy equipment, vehicles, ships and aircrafts, buildings, roads, sewers, bridges, irrigation systems, dam etc.
101. Procedures include
- *There shall be a register for the types of fixed assets the Programme would acquire from time to time. This register should be strictly maintained, in the absence of maintenance of fixed assets account. The register should be maintained at all implementation agencies;*
 - *Periodic physical inventory of fixed assets should be conducted and the result should be compared with the register. Any identified difference should be communicated to management for decision and action;*
 - *The register should have details such as; date of acquisition, the specifics of the asset, type, reference of goods receiving note, location, serial No. and identification no, cost and to the extent possible the account source document, to facilitate reconciliation to be made with the expense account;*
 - *The accountant should extract his records and periodically reconcile with the master fixed assets register of the specific implementing agency. The internal auditor should perform the same at a surprise visit*

102. Stock Management - The FGE accounting manual requires stock accounts to be maintained as assets. However, according to the adopted accounting system of the Government stock balances are not recognized in the accounts as an asset. Therefore, control procedures around memorandum records should be adequate and strictly followed. Procedures:

- *In and out of stock items must be evidenced by goods receiving note and goods issue note and a requisition for issue;*
- *Maintain stock cards for receipts, issue and balances of stock items. The stock cards should be maintained for both quantity and value to the extent possible. The record keeping should be done by someone other than the store man;*
- *Prepare stock taking instructions and programs periodically. Conduct physical count and compare with the card balance. Bring any variance to the management attention, decision and action. Consider accounting for adjustable events, if there are any;*
- *Record cut of documents of stock issue and receipt vouchers as of the year end;*
- *The counting team should sign on the count sheet;*
- *Update stock records by the count;*
- *Internal auditors should review adequacy of adherence to the control procedures*
- *Damaged items should be identified and adjustments should be done on the stock cards based on management decision;*
- *Prepare summary report for monthly stock movements*

3.6. Hand over procedures

103. Traditionally, handover procedure is limited to transfer of property and equipment by an outgoing or a transferred staff to an incoming staff or to warehouses. In WaSH, various studies show that staff turnover seriously affected the project implementation. Hence, it is essential to ensure that the outgoing staff transferred his/her wisdom, knowledge, status of activities and issues to the incoming staff.

104. Preparation of the handover report:

- *Handover reports should be prepared by a staff members who are about to leave their positions, either temporarily (illness, maternity leave etc) or permanently, to assist their successor carry out their duties;*
- *Handover report should be integrated in staff clearance process. The supervisor should indicate that they received a handover report from the leaving staff member during the checkout process;*

- *The purpose of a handover note is to provide the new staff with key knowledge and information regarding the position so that the transition period is as short and smooth as possible and ensure continuity of operations;*
- *In case of a temporary absence, particularly if the absence is longer than four weeks, it is strongly suggested that the staff member shall agree with his supervisor on whether a handover note should be written and if so, how detailed it needs to be.;*
- *A staff member who was temporarily covering the functions due to a colleague's absence shall also write a handover note to ensure a smooth transition back;*
- *Handover report shall be finalized during the week before the staff member leaves his/her position. If this is not possible, the staff member should send the handover note to his/her successor before departing and supplement the note with phone conversations or by email. If the successor has not yet been appointed, the staff member should leave a handover note with his/her supervisor*

105. Distribution of the Handover report - One copy of the handover report shall be submitted to the immediate supervisor and one copy should be filed to archive.

106. Additional documentation to be included in the handover report - The staff required to prepare handover report should also attached working and training manuals which he received in the past because of his position in the project. These include training manuals, procedure manuals and guidelines, software, PAD, FM Manual, POM, working templates and formats.

107. Checklists for the content of the handover report –

- *Name and job title of the outgoing staff (report writer);*
- *Date of Handover report;*
- *Duration of Assignment (include start and end date);*
- *Brief description of duties;*
- *Supervisor and reporting procedures;*
- *Regular/re-occurring meetings, reports or procedures;*
- *Key documents/reference material to read;*
- *Where to find files (hardcopy and electronic);*
- *Calendar of major activities and/or events;*
- *Contacts (internal and external) suppliers, customers, donors, regional and federal offices etc.*

Name	Organization	Phone	E-mail	comments

- Contact information of the leaving employee (phone, email, fax etc)

3.7. Yearend Procedures

108. *Cut-off Procedures* - The following procedures are carried out prior to closure of accounts:

Table 6: Closing Procedures

Step	Activity
One: Generate the Sene Monthly Reports	<p><i>Reconcile cash balance</i></p> <ol style="list-style-type: none"> 1. Count cash in safe 2. Transfer all cash payment vouchers from the cashier to the accountant
	<p><i>Reconcile bank balance</i></p> <ol style="list-style-type: none"> 3. Obtain the bank statement as at 30 Sene 4. Update the bank balance by passing entries for interest, bank charges, credit and debit advises in the General Ledger 5. Reconcile the bank balance per statement to the balances per general ledger
	<p><i>Reconcile transfers</i></p> <ol style="list-style-type: none"> 1. Obtain transfer details from source/destination reporting units 2. compare details with general ledger 3. Make necessary adjustments using journal vouchers. 4. Communicate balances to source/destination reporting units. 5. Ensure transfer account balances agree to balances per source/destination reporting units.
	<p><i>Accrue for grace period payables (Payments from prior year's budges):</i></p> <ol style="list-style-type: none"> 1. Identity amounts paid for in the month of Hamle (during the grace period) for goods/series received/rendered in the month of Sene

2. Use Journal vouchers to accrue for these.

Reconcile receivables and payables general ledger balances to subsidiary ledger

1. For each general ledger account that has subsidiary ledgers, obtain the total of all the subsidiary ledger accounts.
2. Ensure that the total of the subsidiary ledger balances is equal to the general ledger balance and there are no differences.
3. If there is a difference, review the subsidiary ledger accounts and the general ledger account for omission and errors.
4. If the error/omission is in the general ledger, make a correction entry
5. If the error/omission is in the subsidiary ledger, make adjustments directly in the subsidiary ledger.

Reconcile intra-governmental receivable and payables balances:

1. The amount receivable/payable in the books of the reporting unit should be equal to the amount shown as payable/receivable in the books of the related reporting unit.
2. obtain the balance per the other reporting unit
3. Compare the balance with General Ledger
4. Make necessary adjustments using journal voucher
5. Communicate balance to the reporting unit and ensure it makes necessary adjustments so that balances agree.

Verify existence of irregular balances by generating an exceptional any reporting detailing

- Debit balances in revenue accounts
- Credit balances in expenditure accounts
- Credit cash in hand and cash at bank balances
- Credit receivables balances
- debit payables balances

Rectify balances at each step by passing correction entries

Prepare the Sene Monthly report

Verify the Sene monthly report by reviewing each report for reasonableness and there is no cause for any investigation/follow up actions.

Verify that the budgetary institution exists by agreeing the BI code to the budget notification.

Ensure the amount of the approved budget is accurate by agreeing the amount to the budget notification.

Verify that all budget transfers have been recorded by comparing records with the approved project budget.

Verify and resolve any unbalanced budget transfers.

Record any omitted budget transfers.

Verify that all budget supplements have been recorded by comparing records with the approved project budget.

Record any omitted budget supplements

Prepare the budgets vs expenditure report

Review the report for reasonableness.

Review the report for over expenditures and investigate

Two

and resolve over expenditure.

Explain in detail reasons for over and under spends including action taken and to be taken

Make adjustments to expenditure if there has been an error in posting to wrong expenditure account resulting in an over expenditure

After the June monthly report for the fiscal year is accepted by MOFEC, prepare a JV using the June trail balance:

Debit: Revenue/Assistance/loan

Credit: Expenditure

Debit: Transfers-using the credit amount in the trial balance (if any)

Credit: Transfers-using the debit amount in the trail balance (if any)

Debit/Credit: Net Asset/Equity account as debit or credit to make the entry balance.

Record the above JV into the TR and only post the amount for Net Asset/Equity to the General Ledger. The other entries for revenue/assistance/loan, expenditure and transfers should not be posted to the General Ledger for manual users.

Three

Prepare the post-closing Trail Balance with the following accounts;

Debit	Credit
Cash in safe	XXX
Cash at Bank	XXX
Receivables	XXX
Payables XXX	
Net Assets/equity	Debit or credit balance, as the case may be

Carry forward balances in all permanent accounts to the next fiscal year by using new general ledger cards. The beginning balance (equal to last year's ending balance) is recorded on the new ledger card.

A new transaction register is opened every new fiscal year.

Procedures at regional and federal levels are similar.

General Ledger

1. Based on the post-closing trail balance, a set of general and subsidiary ledger cards and sets of budget/expenditure subsidiary ledger cards should be prepared at the beginning of each fiscal year
2. As noted in procedures for closing entry above, the balances in permanent accounts carry forward to the next fiscal year by preparing new General Ledger cards. Therefore, the beginning Balances, which is equal to the last year's ending balance, should be recorded on the new ledger card, via opening journals voucher.

	<ol style="list-style-type: none"> As expense and transfer accounts are closed there no issue of carry forward balances new ledger cards for temporary accounts should be prepared for the new fiscal year
<i>Subsidiary Ledger Cards</i>	<ol style="list-style-type: none"> New subsidiary ledger cards will be opening for permanent accounts that have a carry forward balance. The carry forward balances shall be posted to the new subsidiary ledger cards as a beginning balance of the next fiscal year, which is equal to last year ending balance.
<i>Budget/Expenditure Subsidiary Ledger Cards</i>	<ol style="list-style-type: none"> Budget/expenditure subsidiary ledger cards are valid only for the budget year to which they relate. When budget notification is received, budget/expenditure subsidiary ledger cards should be prepared for each item of expenditure for each budgetary institution. The prior year's budget expenditure subsidiary ledger cards should be filed

109. Retaining of documents - According to Financial Documents Preservation Guideline No 5/1999 of MoFEC, financial documents shall be preserved for ten years from the date they were created or up to two years after the audit by the Auditor General is completed, whichever comes last.

110. Documents refer to all the ledger cards, registers and supporting documents. The OWNPN documents shall be kept separately and shall be filed in a way that makes referring to the documents very easy. The filing system should enable the auditors of OWNPN and anyone who is authorized to check the documents of OWNPN to easily and systematically trace the documents and information they are looking for.

111. Permanent financial files like financial management manual, FM rules & regulations, PAD, POM, Agreements, vouchers, personnel files etc should be kept both in soft and hard copy that enables users to access easily.

112. Current and recent reports like IFRs, regional reports, correspondences on IFRs, checklist, budget amendments, variation, explanations, variance analysis should updated and filed properly to maintain smooth flow information for new comers.

3.8. Financial reporting

3.8.10. Introduction

113. Financial Reporting include the internal financial reports to the management of the program and external financial reports to Development partners. The internal financial reports are both regular and ad hoc or upon request. The regular financial reports to management include monthly reports on the use of resources and status of budget utilization to the management of the implementing entity from the accountant of the project in the implementing entity. The main external report to Development Partners by the program is the quarterly Interim Financial Report (IFR) and annual financial reports.
114. Interim financial reports and annual financial reports will be prepared in accordance with the reporting formats for WASH agreed with the World Bank. The IFR is intended to provide information on whether or not funds disbursed to the Program are being used for the intended purpose, Program implementation is on track, and budgeted costs will not exceed limit.
115. Although every implementing entity that receive fund is accountable for reporting on implementation, MoFEC shall take the overall responsibility for the preparation of IFRs. Apart from its use for monitoring and follow-up Program implementation, the IFR shall be used for making disbursements for the Program. Hence, completeness and accuracy of the IFR is of paramount importance in serving the intended purpose. The timely submission of quality financial reports is necessary to ensure that cash resources flow to the Program as required by the Annual Plan. Financial reports trigger the replenishment of the funds. Because of this, it is vital that WOFEDs, BOFEDs, and MoFEC including the other implementing entities work diligently to submit quality reports on time. If IFRs are not received on or before the due date and are of insufficient quality, disbursements from the Development Partners may be delayed to all regions, until reports of adequate quality are received.

3.8.11. Reporting Procedures

116. An upward reporting stream, in which reports flow from lower level to higher level, shall be implemented for the WaSH as described below and as pre the requirement specified under table 7, Financial Reporting Procedure.
- *WOFED will prepare, using the IFRs' formats as well as the standard monthly government financial reports (i.e. trial balance, expenditure reports, revenue reports, etc.) and send them to the respective BoFEDs;*
 - *WASH Sector Bureaus will send monthly financial reports to BoFEDs, using the IFR standard reporting formats;*
 - *BoFEDs will summarize the reports received from WofEDs and WASH Sector Bureaus, on a quarterly basis, send these summarized reports to MoFEC;*
 - *Federal implementing Agencies (Sector ministries) shall prepare monthly financial reports and send to MoFEC;*

- MoFEC will consolidate the above reports received from BoFEDs and WaSH Sector Ministries, and prepare and send to donors a consolidated IFR for the Program within 60 days after the end of the quarter. The format of the Interim financial reports (IFRs) are annexed in this manual;
- The development partners led by the WB will be responsible for reviewing and clearing the quarterly IFRs;
- Following the reporting arrangement described above and under table 14, additional work is required only at the BoFEDs, to summarize the monthly reports of lower level, and MoFEC to transform the reports into the Program's IFR formats

Diagram: Financial reporting cycle

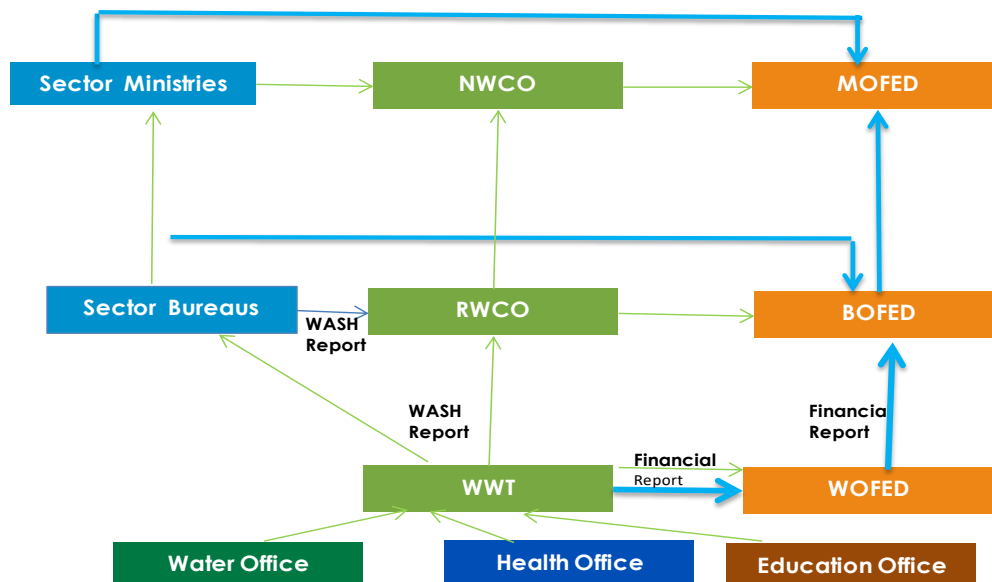

3.8.12. Periodicity of Reporting

117. Monthly reporting - As explained above, monthly reporting shall comprise reporting using the standard government reporting formats. The timeline for sending the monthly reports is as follows:

- WoFEDs shall send the reports to BoFEDs within 15 days of the last day of the month; and
- Implementing sector Bureaus shall send the reports to BoFEDs within 15 days of the last day of the month;
- Implementing sector ministries shall send the reports to MoFEC within 15 days of the last day of the month.

118. Quarterly IFRs - The IFRs shall constitute the quarterly financial reports for the Program. MoFEC will submit consolidated IFR to DPs within 60days after the end of the quarter.

This consolidated IFR will be based on financial reports from implementing Sector ministries and BoFEDs, own expenditures, and federal government contributions and receipts from DPs. The timeline for reporting is described below:

- 30 days after the end of each quarter, BoFED consolidates financial reports to MoFEC
- 60 days after the end of each quarter, MoFEC prepares consolidated ONE-WASH IFR

119. Annual reports – These are mainly prepared for audit purposes. The reporting formats for the annual reports are very similar to the formats used for the quarterly IFRs. The annual report will be the consolidated report of the four quarters subject to adjustments. The final (annual) accounts shall be prepared and submitted to external auditors no later than 3 months after the end of the fiscal year.

Table 7: Financial reports procedures losing

REPORT TYPE OR CONTENT OF REPORT	RESPONSIBLE ENTITY	FREQUENCY OF SUBMISSION	DEADLINE FOR	ACTION
<p>Monthly Report:</p> <p>Trial balance, receivable report, payable report, transfer report, cash count certificates, expenditure report, bank statement & the related bank reconciliation,</p> <p>Quarterly Report (the monthly report at the end of a quarter will include the following schedules in addition to those included in the monthly reports):</p> <p>List of receivables & the related age analysis, list of payables & the related age analysis, budget & actual expenditure comparison by component & sub-</p>	<ul style="list-style-type: none"> ▪ WoFEDs, ▪ Regional Sector Bureaus ▪ Federal Sector Ministries 	Monthly and Quarterly	2 weeks after the end of a month (Fifteen calendar days)	<ul style="list-style-type: none"> ▪ WOFEDs submit to BoFEDs; ▪ Regional Sector Bureaus submit to BoFEDs; ▪ Federal Sector Ministries submit to MoFEC.

<p>component of expenditures and the related explanation</p>				
<p>Quarterly Report:</p> <p>Fund utilization report, Statement of Sources and Uses of Funds, Consolidated & its own trial balance, BoFEDs own receivable & payable report, BoFEDs own cash count certificates, BoFEDs own expenditure report, bank statement & the related bank reconciliation, Consolidated list of receivables & the related age analysis, Consolidated list of payables & the related age analysis, budget & actual expenditure comparison by component & sub-component of expenditures and the related explanation</p>	<p>BoFEDs</p>	<p>Quarterly</p>	<p>One month after the end of the relevant quarter (30 calendar days)</p>	<ul style="list-style-type: none"> ▪ BoFEDs submit to MoFEC

<p>Quarterly IFR:</p> <p>Notes & explanation about project & financial performance, Statement of Sources and Uses of Funds, Statement of Uses of Funds, Statement of Designated Account, Designated account Activity Statements, Cash Forecast, budget utilization and variance analysis, and various schedules supporting the IFR including aging analysis, Special account reconciliation statement, regional or implementing entity's sources and use of fund, bank statement and bank reconciliation statement, statement of fund flow and cash movement for federal and regional implementing agencies, contracts subject to prior and post reviews including payments against contracts subject to prior review</p>	MoFEC	Quarterly	Two months after the end of the relevant quarter (60 calendar days)	MoFEC submit to WB or development partners
Annual Financial Statements	MoFEC	Annually	3 months after the end of the fiscal year	MoFEC submit draft financial statements to auditors
Audit Report	MoFEC	Annually	Within 6 months after the end of the fiscal year	After collecting from auditors MoFEC submits audit report & audited financial statements to DPs and discloses for public.

3.9. Auditing

3.9.13. Internal Audit

120. Internal audits – As per regular government procedures, the internal auditor of each agency (i.e. MoFEC, BoFEDs, WoFEDs, sector Ministries, sector Bureaus, and other implementing agencies) shall perform an internal audit on the program fund. Thus, all the internal audit units of the mentioned agencies shall routinely include the Program in their work plan and conduct regular audit on the Program funds. The report of the implementing agencies' internal auditors shall be addressed and submitted to the head of the Agency. However, major findings during an audit shall be communicated to MOFEC immediately for corrective action.
121. The audit includes a periodic review (post audit) of effectiveness and compliance with financial and accounting policies and procedures and internal control mechanisms; the overall reliability of accounting system, data and financial reports.
122. It is imperative that the internal auditors carry out the financial audit for the Program. Internal auditors shall keep a copy of the proceeding internal audit report and make them available for external auditors and the DPs' supervision missions.
123. Past lessons indicate that the internal audit function in all regions and woredas visited was found to be especially weak. These weaknesses are systemic and well-recognized by MoFEC, and many reform activities are planned and underway by the EMCP/MoFEC to improve the internal audit system. In the meantime, through this program certain mitigation measures are agreed:
- *Hire/assign internal auditors at MoFEC and BoFED to conduct internal audits;*
 - *The recruited Internal Auditors will supervise the project's internal control system every six months and furnish the status report to the WB within 60 days of the end of the semester;*
 - *Conduct capacity building trainings on internal audits along with the FM Manual trainings;*
 - *The WB/DPs will continue to track the performance of internal auditors as to whether the project was subject to internal audit reviews.*

3.9.14. External Audit

124. According to the Ethiopian Constitution, the Office of Federal Auditor General (OFAG) is responsible for carrying out the audit of all the financial transactions of the federal government and subsidies to the regions. Each of the regions has a regional Auditor General responsible for auditing financial transactions in the region. Although the responsibility for the preparation of financial statements of the program and for getting them audited rests with MOFEC, every program implementing entity has responsibility to cooperate with external auditors. MoFEC will have the project financial statements audited by OFAG or an auditor assigned by OFAG. When OFAG decide to assign independent audit firm to handle the financial audit, the auditor to be selected should be acceptable to the World Bank. There should be rotation of auditors and an

independent audit firm should be allowed to audit the project financial statements for a maximum of three years. The project is subject to external audit throughout the life of the project.

125. The auditor is responsible for forming and expressing opinion on the financial statements. The audited financial statement will include all sources of funds for the program, including the Government. The auditor will prepare a work plan to ensure adequate coverage of the various institutions that receive project funds and cover all the major risk areas. The audit of the project will be carried out in accordance with the terms of reference for external audit and International Standards on Auditing (ISA) promulgated by the International Federation of Accountants (IFAC), and with relevant World Bank guidelines, and will include such tests and auditing procedures, as the auditor will consider necessary under the circumstances. In complying with International Standards on Auditing, the auditor is expected to pay particular attention to fraud and corruption, laws and regulations, governance and risks. The content of the program financial statements are all included in the audit TOR agreed with the Bank. The audit report should include follow up on the audit recommendations noted by audit reports at the different implementing entities. In addition to the audit of the Project Financial Statements, the auditor is required to verify IFRs used as a basis for the submission of loan withdrawal applications to the World Bank. The auditor will apply such tests and auditing procedures as considered necessary under the circumstances.
126. The auditor will prepare audit report (that includes the audited financial statements, the opinion on the financial statements and states of affairs of the program and a complete Management Letter) in a form and content satisfactory to the WB/development partners and will submit the report to MoFEC. MoFEC will then submit the complete audit report to the DPs within 6 months after the end of each Fiscal year. The World Bank, as indicated in the POM, is responsible to review, give comments, if any, and clear the audit reports.
127. Audit reports shall be addressed to MoFEC. MoFEC will be responsible for preparing action within two months of submission of audit report and submits the same to all implementing entities for follow up. The action plans will also be sent to development partners. All the relevant public bodies at all levels should respond immediately to recommendations and findings to which they are responsible to enable MoFEC submit action taken and would be taken in time to the development partners.
128. MoFEC should also follow up on actions taken as planned in the Action plans thereby following up with Regions and implementing entities to take actions. Progress update of status of actions taken will be reported to DPs as well.
129. Once finalized and issued by MoFEC and submitted to DPs, the external audit report is subject to public disclosure. The World Bank in line with its policy requires recipients to disclose audited financial statements in a manner acceptable to the Bank. Following the Bank's formal receipt of audited financial statements from recipients, the Banks makes them available to the public in accordance with the World Bank Policy on Access to information.

1. OWNP Administration

130. As clearly indicated in the program design document, the highest governing body in the Program is the National WASH Steering Committee (NWSC) whose members include Ministers and State Ministers from the ministries of Water, Irrigation and Electricity, Health, Education and Finance and Economic Cooperation. The NWSC is chaired by the Minister of Water, Irrigation and Electricity.
131. The technical arm of the NWSC is the National WASH Technical Team (NWTT) consisting of Directors from the four WASH ministries. A similar structure is prescribed at regional level. The lowest level of WASH governance is the woreda. At woreda level WASH activities are implemented by the District WASH Team led by the District Administrator. Its members are from the four WASH sector offices (Water, Health, Education and Finance with additional members from the Women Affairs and Agriculture offices). Development partners are presently represented by the Development Assistance Group – Water Technical Working Group.
132. A National WASH Coordination Office (NWCO) will be responsible for coordinating, planning and oversight of Program implementation at federal level. The NWCO will report to a National Steering Committee chaired by the Minister of Water, Irrigation and Electricity and supported by a National WASH Technical Team consisting of representatives from participating ministries and partners. Implementation of the Program in the sector ministries will be the responsibility of WASH Program Management Units (PMUs) in the ministries of Water, Irrigation and Electricity, Health, Education and Finance and Economic Cooperation, respectively. The NWCO needs to ensure that there is strong communication, coordination and linkage between the NWCO and the PMUs at all level.

3.10. Organizational Structure

133. Organizational structures for program management should be responsible and accountable for implementation of the program and for timely progress and expenditure reporting that adheres to government policies and guidelines.
134. The program coordinators, at all levels of government and city administrations, will be assisted by full time key staffs and accountable to the respective coordinator. In order to effectively implement the Program, the following minimum staffing package is proposed. Focal persons are not full-time staff, but will perform their Program-related tasks alongside other duties.
135. The staff capacity assessment will be conducted and staffing plan will be developed to be reviewed at mid-term. The staffing minimum requirements for the financial management of the Program are summarized in Table 8.

Table 8: Staffing Requirements

INSTITUTION	STAFFING ARRANGEMENTS
Federal Level	<p>WASH Coordinator</p> <p>PMU coordinator(one for each of the four ministries)</p> <p>M&E specialist</p> <p>Procurement specialists</p> <p>Financial management/specialist Accountant (2)</p> <p>Community management expert)</p> <p>Water supply engineer</p> <p>S&H expert</p> <p>Environmentalist</p>
Regional level	<p>WASH Coordinator(1 for each of the four bureaus)</p> <p>Community management expert</p> <p>Water supply engineer</p> <p>Procurement Specialists</p> <p>S&H Specialist</p> <p>Environmentalist</p> <p>Financial management specialist (1)</p> <p>Accountant (2 for big regions and 1 for emerging regions)</p> <p>M&E specialist</p>
Zonal level	<p>WASH focal person</p> <p>Sanitation and hygiene specialist</p> <p>M&E specialist</p> <p>Financial management/accounting (1/1)</p>

INSTITUTION	STAFFING ARRANGEMENTS
Woreda level	WASH focal person(1) Environmental sanitation specialist M&E specialist Procurement and contract management focal person Financial management/accounting) (1/1) Community management specialist Water supply technician
Town/City level	WASH focal person (1) M&E focal person (1) Procurement and contract management focal person (1) Financial management/accounting focal person (1) Customer relations focal person (1) Water supply engineer (1) S&H Specialist (1) Sanitation and hygiene specialist

136. The staff capacity assessment will be conducted and staffing plan will be developed to be reviewed at mid-term. The staffing minimum requirements for the financial management of the Program are summarized in Table 8.

3.11. Salary Scale

137. The Program will not pay salaries to civil servants as they are ineligible. Top up allowances are also not allowed. Contract staff salaries are as per the government procedures as approved by MoFEC. Any revisions to the salary scale will be communicated to all implementing entities by MoFEC.

3.12. Personnel Management

138. Other personnel management procedures – like employment, , insurances, gender and social inclusiveness, pension arrangements disciplinary measures employment conditions will be governed by the government personnel management procedures and contract agreements.

3.13. Per diems

139. A daily allowance, that an implementing agencies of Channel One programs including WaSH, pay an employee for expenses to cover living expenses, when travelling on mission outside his or her duty station, has been decided by the Ministry of Finance and Economic Cooperation. Effective program implementation can only be assured if implementing agencies can regularly conduct supervision of works, monitoring of community activities and periodic consultation at all level. The government per diem rate will be applicable to the OWNPs.

3.14. Taxation

140. It is important to note that the program will be subjected to the tax laws of the land and all partners financing the programs will thereby finance taxes as well. However, the National WaSH Steering Committee should identify WASH investment areas where tax and custom privileges to the program can bring reduction of costs and can enhance effectiveness of the Program. The priority WASH investment areas for tax and custom privileges should be submitted for the approval of the Government of Ethiopia as soon as possible in order to gain the advantages for the program.

4. Annexes

4.1. Annex 1: Auditor Terms of Reference

ONE WaSH NATIONAL PROGRAM

TERMS OF REFERENCE (TOR) FOR THE FINANCIAL AUDIT

1. Background

The **One WaSH National Program** (OWNP) is the Government of Ethiopia's (GoE) main instrument for achieving the goals set out for WaSH in the Growth and Transformation Plan (GTP). The program was designed to be implemented in two Phases. Phase I is covering the period from July 2013 to June 2015 and Phase II from July 2015 to June 2020. Phase I of one WaSH, as is specified in the One WaSH national program, is designed to increase harmonization and alignment among and between development partners and the GoE. During this phase WaSH organizations and procedures are supposedly to be fully established and become operational at all levels. Plus during this Phase I, partners, including Civil Society Organizations (CSOs) are expected to increasingly align their targets, plans and activities with the program and strengthen coordination in planning, implementation, monitoring and reporting of all WASH activities amongst stakeholders at different levels. Any new WaSH programs or new phases of existing WaSH programs are also expected to align with the Program's principles, approaches and plans.

It is envisaged that ONE WaSH Program will follow the modalities of the Sector-Wide Approach (SWAP) because it allows enhancement of development impact by scaling up, building stronger donor partnerships in support of country-led sector reform Programs, and improving the performance of institutions in managing all sector resources. The SWAP approach also presents particular opportunities and challenges for the harmonization of procedures by participating donors and more effective pooling of resources.

The Program's Development objective is to improve the health and well-being of communities in rural and urban areas in an equitable and sustainable manner by increasing access to water supply and sanitation and adoption of good hygiene practices.

This government program is proposed to have the following program structure.

Component	Total (in USD million)
Rural WASH	243.15
Urban	121.69
Program Management and Capacity Building	35.72
Total	485.12

The Development partners in addition to WB that are involved in financing this program known at appraisal include DFID, AfDB and UNICEF.

The institutional arrangements for the Program will build on existing structures. Although Ministry of Water Resource, Irrigation and Energy is responsible for the overall project, the Ministry of Finance and Economic Development (MOFEC) will be responsible for the financial management aspects of the program. At Regions or Woredas the Regional or Woreda bureaus or offices of both Ministries will be involved in respective areas in managing the program.

The accounting period covered for the audit is 12 months following the government fiscal year ending on July 7. The Audit will be completed on an annual basis following the normal government fiscal/accounting year.

Detailed information on the project including implementation arrangements is provided in the program Appraisal Document (PAD).

2. PREPARATION OF ANNUAL FINANCIAL STATEMENTS

The responsibility for the preparation of financial statements of sub program including adequate disclosure is that of MoFEC. MOFEC is also responsible for the selection and application of accounting policies. MoFEC would prepare the PFSs in accordance with IPSAS (International Public Sector Accounting Standards) as promulgated by the International Federation of Accounts (IFAC). The Government's accounting system outlined in the Manual Federal Accounting System-based on modified cash basis of accounting can also be used.

The auditor is responsible for forming and expressing opinions on the financial statements. The auditor would carry out the audit of the Program in accordance with the International Standards on Auditing (ISA), as promulgated by the International Federation of Accounts (IFAC), with special reference to ISA 800 (Auditor's Report on Special Purpose Audit Engagements) and to relevant World Bank guidelines. As part of the audit process, the auditor may request from MoFEC written confirmation concerning representations made in connection with the audit.

3. Objective

The objectives of the audit of the program Financial Statements (PFSs) is to enable the auditor to express a professional opinion(s) on the financial position of the program at the end fiscal year, and on funds received and expenditures incurred for the relevant accounting period. The accounting system, books and records provide the basis for preparation of the PFSs by the program implementing agency and are established to reflect the financial transactions in respect of the project. MOFEC and the rest of the implementing agencies maintain adequate internal controls and supporting documentation for transactions.

4. SCOPE OF THE AUDIT

As stated above, the audit of the project will be carried out in accordance with International Standards on Auditing (ISA) promulgated by the International Federation of Accountants (IFAC), and will include such tests and auditing procedures as the auditor will consider necessary under the circumstances. Special attention should be paid by the auditor as to whether the:

- a) World Bank financing (and all external financing where the World Bank is not the only financier) has been used in accordance with the conditions of the relevant financing agreement, with due attention to economy and efficiency, and only for the purposes for which the financing was provided – please see <Water Supply, Sanitation and Hygiene Project (WASHP- p133591)
- b) Counterpart funds have been provided and used in accordance with the relevant financing agreements, with due attention to economy and efficiency, and only for the purposes for which they were provided;
- c) Goods, works and services financed have been procured in accordance with the relevant financing agreements including specific provisions of the [World Bank Procurement Policies and Procedures](#)³;
- d) All necessary supporting documents, records, and accounts have been maintained in respect of all project activities, including expenditures reported using Interim Unaudited Financial Statements (IFS) methods of reporting. The auditor is expected to verify that respective reports issued during the period were in agreement with the underlying books of account;
- e) Designated Accounts have been maintained in accordance with the provisions of the relevant financing agreements and funds disbursed out of the Accounts were used only for the purpose intended in the financing agreement;
- f) National laws and regulations have been complied with, and that the financial and accounting procedures approved for the project (e.g. operational manual, financial procedures manual, etc.) were followed and used;
- g) Financial performance of the project is satisfactory.
- h) Assets procured from project funds exist and there is verifiable ownership by the implementing agency or beneficiaries in line with the financing agreement.
- i) Ineligible expenditures included in withdrawal applications are identified and reimbursed to the Designated Accounts. These should be separately noted in the audit report.

In complying with International Standards on Auditing, the auditor is expected to pay particular attention to the following matters:

- a) **Fraud and Corruption:** Consider the risks of material misstatements in the financial statements due to fraud as required by ISA 240: [The Auditor's Responsibility to Consider Fraud in an Audit of Financial Statements](#). The auditor is required to identify and assess these risks (of material misstatement of the financial statements) due to fraud, obtain

³ Depending on the complexity of procurement activities, the auditor may consider involving technical experts during the audit engagement. In cases where such experts are involved, the auditor is expected to comply with provisions of [International Standard on Auditing 620: Using the Work of an Expert](#). Consideration to use of the work of experts should be brought to the early attention of the borrower and the World Bank for mutual agreement and appropriate guidance.

sufficient appropriate audit evidence about the assessed risks; and respond appropriately to identified or suspected fraud;

- b) **Laws and Regulations:** In designing and performing audit procedures, evaluating and reporting the results, consider that noncompliance by the implementing agency with laws and regulations may materially affect the financial statements as required by [ISA 250: Consideration of Laws and Regulations in an Audit of Financial Statements](#);
- c) **Governance:** Communicate audit matters of governance interest arising from the audit of financial statements with those charged with governance of an entity as required by International Standards on Auditing 260: Communication of Audit Matters with those Charged with Governance.
- d) **Risks:** In order to reduce audit risk to an acceptable low level, determine the overall responses to assessed risks at the financial statement level, and design and perform further audit procedures to respond to assessed risks at the assertion level as required by Internal Standard on Auditing 330: the Auditor's Procedures in Response to Assessed Risks.

5. PROJECT FINANCIAL STATEMENTS (PFSs)

The auditor should verify that the project PFSs have been prepared in accordance with the agreed accounting standards (see paragraph 3 above) and give a true and fair view of the financial position of the project at the relevant date and of resources and expenditures for the financial year ended on that date

The Project Financial Statements (PFSs) should include:

- a) A statement of funds received, showing funds from the World Bank, project funds from other donors and counterpart funds separately, and of expenditures incurred;
- b) A summary of the activity in the Designated Account;
- c) A Balance Sheet (if deemed necessary);
- d) A Summary of the principal accounting policies that have been adopted, and other explanatory notes;
- e) A list of material assets acquired or procured to date with project funds

As an Annex to the PFSs, the auditor should prepare a reconciliation of the amounts as "received by the Project from the Financers", with those shown as being disbursed by these Financers.

6. Interim Financial Report (IFRs)

In addition to the audit of the PFSs, the auditor is required to verify all IFRs used as a basis for the submission of loan withdrawal applications to the World Bank. The auditor will apply such tests and auditing procedures as considered necessary under the circumstances. Annexed to

the PFSs should be a schedule listing individual IFR withdrawal applications by specific reference number and amount.

The total withdrawals under the IFR procedures should be part of the overall reconciliation of Bank disbursements described in paragraph 5 above.

7. DESIGNATED ACCOUNT

In conjunction with the audit of the Project PFSs, the auditor is also required to review the activities of the Designated Account associated with the project. The Designated Account usually comprises:

- Advance deposits received from World Bank;
- Replenishments substantiated by withdrawal applications;
- Interest that may have been earned on the accounts, and which belong to the recipient; and
- Withdrawals related to project expenditures

The auditor should pay particular attention as to the compliance with the Bank's procedures and the balances of the Designated Accounts at the end of the fiscal year (or period). The auditor should examine the eligibility of financial transactions during the period under examination and fund balances at the end of such a period, the operation and use of the DAs in accordance with the relevant general conditions, relevant financing agreements and disbursement letter, and the adequacy of internal controls for this type of disbursement mechanism.

For this Project, the Designated Accounts are referred to in the general conditions, the Financing Agreement (subsection 5.3) and Disbursement Letter (para. I).

The auditor should also examine eligibility and correctness of:

- Financial transactions during the period under review;
- Account balances at the end of such a period;
- The operation and use of the Designated Account in accordance with the financing agreement; and
- The adequacy of internal controls for the type of disbursement mechanism.

8. AUDIT REPORT

The auditor will issue an opinion on the project financial statements (PFSs). The annual audit report of the project accounts should include a separate paragraph highlighting key internal control weaknesses and non-compliance with the financing agreement terms.

9. MANAGEMENT LETTER

In addition to the audit report, the auditor will prepare a management letter, in which the auditor will:

- a) Give comments and observations on the accounting records, systems and controls that were examined during the course of the audit;
- b) Identify specific deficiencies or areas of weakness in systems and controls, and make recommendations for their improvement;
- c) Report on the degree of compliance of each of the financial covenants in the financing agreement and give comments, if any, on internal and external matters affecting such compliance;
- d) Communicate matters that have come to his/her attention during the audit which might have a significant impact on the implementation of the project;
- e) Give comments on the extent to which outstanding issues/qualifications issues have been addressed;
- f) Give comments on previous audits' recommendations that have not been satisfactorily implemented; and
- g) Bring to the recipient's attention any other matters that the auditor considers pertinent, including ineligible expenditures.

Ideally, the management letter should also include responses from the implementing agency to the issues highlighted by the auditor.

10. AVAILABLE INFORMATION

The auditor should have access to all legal documents, correspondences, and any other information associated with the project and deemed necessary by the auditor. The auditor will also obtain confirmation of amounts disbursed and outstanding at the Bank. Available information should include copies of the relevant: project appraisal document; financing agreement; financial management assessment reports; supervision mission reports and implementation status reports.

11. GENERAL

The financial statements, including the audit report, management letter and management response should be received by the Bank no later than xxx months after the end of the accounting year to which the audit relates.

The auditor should submit the report to the recipient's designated agent rather than to any staff member of the project entity. The agent should then promptly forward two copies of the audit report and accompanying statements to the Bank together with the management letter and management response.

It is highly desirable that the auditor becomes familiar with the Bank's Guidelines on Annual Financial Reporting for World Bank-Financed Activities, June 30, 2003, which summarizes the Bank's financial reporting and auditing requirements. The auditor should be familiar with World Bank Procurement Guidelines, which can be obtained from the project implementing agency. The auditor should also be familiar with the Bank's Disbursement Handbook for World Bank Clients, Disbursement Guidelines for Projects; May 2006. These documents are available on the Bank's website and could be obtained from the Task Team Leader.

4.2. Annex 2: Ineligible Expenses

Ineligibility: The following payments should not occur in the project as they have implications on eligibility of the expenditure incurred:

Type of Allowance	Eligibility	Comments
Salary top-up to Civil/Public Servants	Not allowed	Civil/Public Servants are paid to work for the government. Given that donor-financed projects are owned by the Government, the civil servants are still working for the Government when they provide support in implementing projects
Sitting allowance to Civil/Public Servants (for attending workshops, Project Steering Committee meetings, other committee meetings, etc.)	Not allowed	
Honorarium to Civil/Public Servants (payment for services performed in committees, meetings, workshops, etc.)	Not allowed	
Internal consulting of public and civil servants currently on the government payrolls	Not allowed	<p>This could amount to double payments to government employees. The government should not be paying consulting fees to staff on its payroll.</p> <p>A government employee may take a leave of absence (without pay) to work in another sector and be paid consulting fees by the government/project. The General conditions for hiring Government officials and civil servants under consulting contracts in Bank financed projects** are set forth in Par. 1.11(d) of the Consultant Guidelines. The Government officials and civil servants cannot be hired under any circumstances by the agency for which they previously worked, or if their employment would create a conflict of interest. When hired as individual consultants to work in another sector, they would have to be on leave without pay for the expected duration of their consultant contract before signing it.</p>

		When members of a team of a consulting firm, they would have to be on leave without pay at the time the consulting firm submits its proposal.
Travel and Transport	For this project either as per Government policies/directives or if different, as per policies/directives proposed by the DG and approved by MoFEC	Receipts are required for local travel expenses; receipts required for actual cost reimbursement accommodation but not for lump sum hotel allowance; and receipts required for incidental expenses. Gasoline purchased for personal vehicles are not reimbursable.
Per Diem	For this project either as per Government policies/directives or if different, as per policies/directives proposed the DG and approved by MoFEC	Receipts are required for local travel expenses; receipts required for actual cost reimbursement accommodation but not for lump sum hotel allowance; and receipts required for incidental expenses. Gasoline purchased for personal vehicles are not reimbursable.
Sitting allowances, honorarium, etc. to consultants financed under a project (for attending workshops, Project Steering Committee meetings, other committee meetings, etc.)	Not allowed	Consultants are contracted and paid reasonable fees to render services to the project