

## Technical Brief No. 36: Ferrocement water tanks

Ferrocement consists of a cement-rich mortar reinforced with layers of wire mesh, sometimes with additional plain wire reinforcement for added strength. Tanks made of ferrocement are used in many countries for the collection and storage of water for drinking, washing, for animal use and irrigation.

Ferrocement tanks have several advantages over tanks made of concrete or brick:

- They are usually cheaper to build and require less skilled labour.
- They are able to withstand shock better, as ferrocement is more flexible.
- Smaller ferrocement tanks are portable.

Ferrocement tanks vary in capacity, size, and shape. They are built by hand-trowelling layers of cement mortar onto a wire frame which is either free-standing or held in place by temporary or permanent structures known as 'formwork'.

Ferrocement is only needed for tanks of capacities greater than 1000 litres. Below this size, cement mortar alone is strong enough to withstand the applied loads.

**Tanks used for storing drinking-water must always be covered to avoid contamination and so maintain drinking-water quality.**

Fittings are usually built into the ferrocement during construction. These include:

- one or more taps for water collection;
- a drainage tap (or wash-out) at the bottom of the tank, to be used when cleaning;
- an inlet pipe; and
- an overflow pipe. This must be screened to prevent insect entry.

A tank may be sited above ground or below ground, or it may be partially sunk (provided its base is situated well above groundwater level).

Plastering the inside of a ferrocement tank



### Methods of construction

There are different methods of constructing ferrocement water tanks.

- **Building tanks without using formwork**  
This method requires a stiff wire frame around which flexible mesh such as 'chicken wire' is wrapped. The first layer of mortar is applied by a mason working on one side of the tank, with an assistant on the other side holding a plastering float in the right place to allow the mortar to be compacted without it falling through the mesh.
- **Building tanks using temporary formwork**  
Temporary formwork, made of wood, flat or corrugated sheets of steel, or coiled pipe is placed against one face of the tank during the application of the initial layers of mortar. The formwork is removed before plastering the inside of the tank.
- **Building tanks using permanent formwork**  
Formwork, such as corrugated sheets, may be left in place permanently, plastered on both the inside and the outside.
- **Centrally produced tanks**  
Smaller sizes of ferrocement tanks can be centrally produced and transported in one piece to their point of use. Larger sizes of tank have to be built in sections. Central production has the advantage of better quality control, but the transportation costs may make the tanks unaffordable.

# Technical Brief No. 36: Ferrocement water tanks

## Simplified stages of construction of a ferrocement tank

### 1. The foundation is prepared

- The levelled site is cleared of debris
- Topsoil is removed to a depth of 100mm

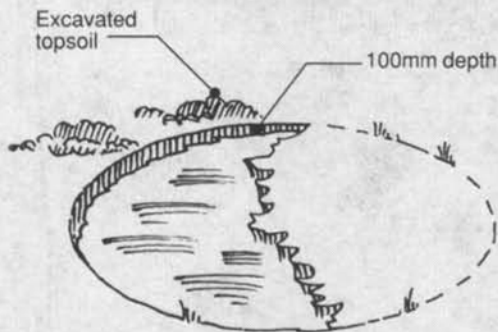

### 2. The base slab is laid

- The site is covered with 50mm of concrete
- Wire reinforcement, with steel supports attached, is placed over the concrete before it sets
- A second layer of concrete is laid over the wire reinforcement to ground level

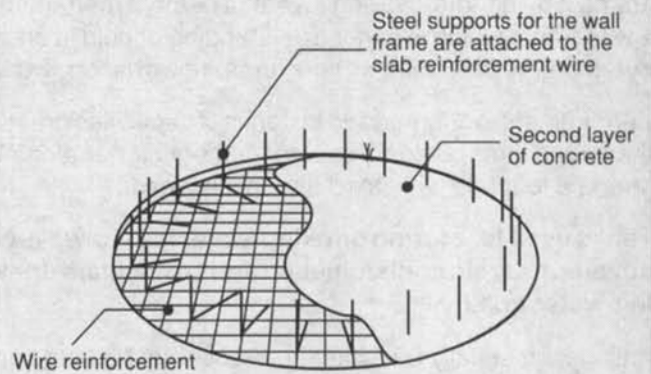

### 3. The wall frame is constructed

- The wall reinforcement is attached to the steel supports using binding wire
- For larger tanks, wooden shuttering may be constructed to give added support to the wire frame

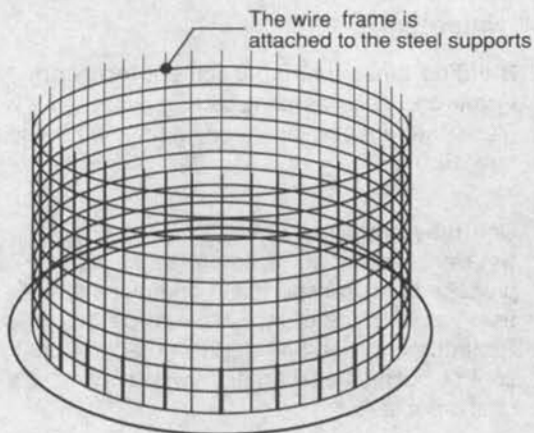

### 4. Mesh is attached to the frame

- Layers of wire mesh (or 'chicken wire') are attached to cover the frame on both the outside and the inside

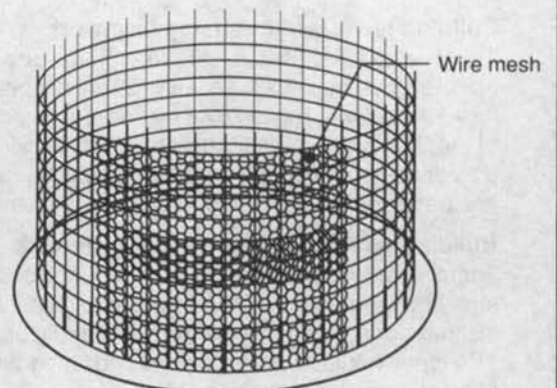



## 5. Fittings are installed

- Fittings are attached to the wire reinforcement before the walls are plastered. The tap below is held securely in place by a plate welded to the pipe and embedded in the ferroceement.
- Additional cement mortar is plastered around the tap to prevent leakage.

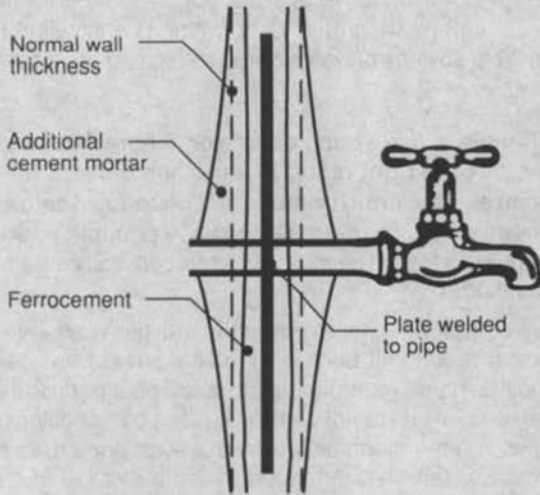

Section

## 6. Plastering

- The tank is plastered on the outside first

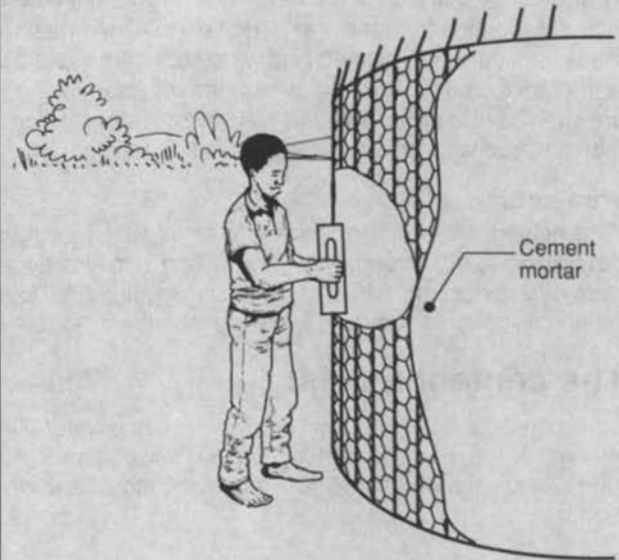

## 7. The plastered tank

- When the cement mortar is set on the outside, stepladders are used to access the inside of the tank, which is also then plastered.

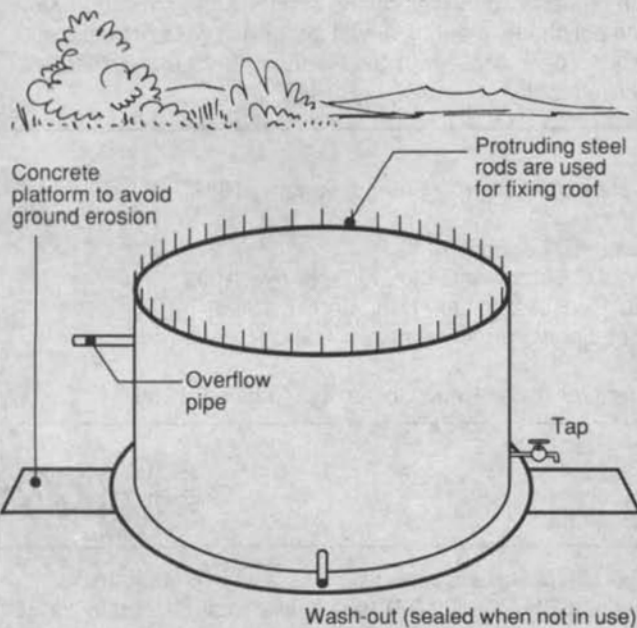

## 8. Roofs

- To prevent evaporation, pollution, and the breeding of mosquitoes, all tanks should have roofs.
- Arched ferroceement roofs are increasingly being used, because they are cheaper than those made of reinforced concrete.
- Roofs with spans of up to 2.5m are usually free spanning from the wall of the tank. Larger spans are usually supported by a central prop.



Roof shapes - sectional view

# Technical Brief No. 36: Ferrocement water tanks

## Further points to consider

Careful selection of materials and proper mixing and curing of the cement mortar are important in order to produce watertight tanks.

### The reinforcing wire

It is important to get a good distribution of wire mesh throughout the cement mortar to limit cracking.

Wire meshes come in a wide variety of types, diameters, stiffnesses, and strengths. For large tanks welded meshes made from the larger diameters of wire (above 4mm) welded at 100mm to 200mm spacing to a square or rectangular grid are often used to provide a strong reinforcing frame, which is then covered with smaller sizes of mesh or netting.

### Wire netting

Wire netting, often called 'chicken wire' is very useful for distributing loads through the mortar and into the larger diameter reinforcing wires. It is easily moulded to form spherically shaped surfaces, such as arched roofs to tanks.

### The cement mortar

Cement mortar is a mixture of sand, cement, and water. The strength of the mortar depends on these raw materials, the mix ratio, and the workmanship of those who mix and use the mortar.

### Sand

Clean, dry sand should be used. It should be well-graded, comprising particles of different sizes.

### Cement

Cement should have been recently manufactured and have been protected from water vapour during storage and transport.

### Water

The water used in the mix needs to be clean, preferably of drinking-water quality.

### The cement:sand ratio

The usual ratio of cement to dry sand is 1:3 by volume. To achieve the desired ratio, a bucket can be used to accurately measure out the proportions of sand and cement. (Note that

when sand from a stockpile is damp it has a greater volume than when it is dry). As cement 'bulks', it is preferable to use a full bag of known volume.

### The water:cement ratio

The ratio of water to cement has an important effect on the final strength of the mortar. A ratio of about 0.4:1 to 0.5:1 (ratio of water:cement by weight) is ideal, which is equivalent to between 20 to 25 litres of water to each 50kg bag of cement.

### Mixing

**It is preferable to use a concrete mixer. Where this is not possible, mix the right ratios of sand and cement on a hard, clean surface until the mixture is of uniform colour.**

Cast a mixing slab if necessary, or use a portable mixing trough to prevent loss of cement and to prevent soil contaminating the mortar.

### Add only sufficient water to make the mortar 'workable'.

If the mortar is too stiff because too little water has been added it will be hard to compact; it will have a poor bond to the reinforcement; and it will not be held in place by adhesion to the formwork. If the mortar is too wet it will produce a weak and permeable tank. Water should never be visible in the mixed mortar, even when it is left undisturbed in a pile.

**Mixed mortar should be used immediately.** Extra water should never be added to soften the mortar once it has started to set. Cover or shade the mixed mortar in hot weather and turn the pile over regularly.

**Compact the mortar well by pushing it hard against the formwork.**

### Curing

**Once the mortar has set, keep it damp for at least two weeks and preferably longer.** This curing is important for the proper gain of strength and the prevention of cracking. It can be assisted by wetting the surfaces and covering them with polythene sheeting or wet sacking. It will still be necessary to periodically wet the surfaces before they can be allowed to dry.

### For further information:

Hasse, R., *Rainwater reservoirs above ground structures for roof catchment*, Vieweg & Sohn, Germany, 1989.  
(Also available from IT Publications, London.)

Watt, S.B., *Ferrocement water tanks and their construction*, IT Publications, London, 1978.

Nissen-Petersen, E., *How to build an underground tank with dome*, ASAC Consultants Ltd., Kitui, Kenya, 1992.

Nissen-Petersen, K., *How to build smaller water tanks and jars*, ASAC Consultants Ltd., Kitui, Kenya, 1992.

Sharma, P.C. and Gopalratnam, V.S., *Ferrocement water tank*, International Ferrocement Information Center (IFIC), Asian Institute of Technology, Bangkok, Thailand, 1980.

Chindaprasirt, P., et al. *A study and development of low-cost rainwater tank*, Khon Kaen University, Thailand, 1986.

Prepared by Bob Reed, Rod Shaw, and Brian Skinner

Water, Engineering and Development Centre (WEDC),

Loughborough University of Technology, Leicestershire, LE11 3TU, England.



Thirty-sixth in a series of Technical Briefs for fieldworkers. Technical Briefs Nos.1-32 are now available in book form. *The Worth of Water: Technical briefs on health, water, and sanitation* (ISBN 1 85339 071 2) is available at £9.95 plus £2.50 P&P from IT Publications, 103-105 Southampton Row, London WC1B 4HH, UK.