

# Decentralised Composting for Cities of Low- and Middle- Income Countries

## A Users' Manual



**Eawag / Sandec**  
Silke Rothenberger  
Christian Zurbrügg

**Waste Concern**  
Iftekhar Enayetullah  
A. H. Md. Maqsood Sinha



**eawag**  
aquatic research 000

Sandec  
Water and Sanitation in  
Developing Countries

DECA  
DDC  
DPC  
SDC  
COSUDE



# Decentralised Composting for Cities of Low- and Middle- Income Countries

**A Users' Manual**

**Eawag / Sandec**  
Silke Rothenberger  
Christian Zurbrügg

**Waste Concern**  
Iftekhar Enayetullah  
A. H. Md. Maqsood Sinha

---

**Publisher:** Waste Concern, House - 21 (Side B), Road - 7, Block - G,  
Banani Model Town, Dhaka-1213, Bangladesh; and  
Eawag, P.O. Box 611, 8600 Duebendorf, Switzerland

**Copyright:** 2006 - Published texts and figures may be reproduced  
freely for non-commercial purposes only (except when reproduction  
or translation rights are explicitly reserved), provided that mentions  
is made of the authors and this publication.

**Circulation:** 1000 copies (to be ordered from [www.sandec.ch](http://www.sandec.ch) or  
[www.wasteconcern.org](http://www.wasteconcern.org))

ISBN 978-3-906484-36-5

---

## Foreword

This book is about converting organic waste into resource - a partnership - based and decentralised approach to waste composting. It is based on actual ground level experience of Waste Concern-our partner organisation in implementing several decentralised composting projects in Dhaka as well as replication in Bangladesh and other Asian cities.

Solid waste management has become a major environmental problem for the fast growing towns and cities of low and middle-income countries. Most urban local bodies in the developing countries are cash-strapped and unable to provide satisfactory waste management services. In most cities not even 50 percent of the generated waste is collected. The present solid waste management system in developing countries is based on the "end of the pipe" solution, i.e., collection - transportation - crude dumping of waste with limited recycling of inorganic waste, mainly by the informal sector.

The physical composition of solid waste of the developing countries consists mostly of organic matter, which is biodegradable. When organic waste remains uncollected in the streets, drains or when disposed in open crude dump sites, it poses three major environmental problems: firstly, ground and surface water pollution through leachates; secondly, spread of disease vectors from open and uncovered waste dumped in crude dump sites; and thirdly, emission of methane which is a major green house gas due to anaerobic condition in the dump sites.

In order to avoid the solid waste - triggered environmental hazards, use of compost needs to be promoted. One of the sustainable approaches is to look at waste as a resource, not as a problem. This manual demonstrates that it is possible to turn waste into jobs and opportunity for the poor, and improve food security.

This manual provides step-by-step guidelines on how to initiate a decentralised composting project in a developing country. It is our hope that this resource book on composting and solid waste management will prove to be indispensable to communities and practitioners alike, especially for the urban local bodies, private sector and NGOs.

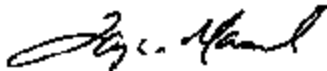

Larry Maramis  
Deputy Resident Representative  
United Nations Development Programme (UNDP), Bangladesh

---

## Foreword

Urban solid waste management is considered to be one of the most immediate and serious environmental problems confronting urban governments in developing countries. The severity of this challenge will increase in the future given the trends of rapid urbanisation and growth in urban population.

Inadequate collection and disposal of waste poses a serious health risk to the population and is an obvious cause of environmental degradation in most cities of the developing world. With growing public pressure and environmental legislation, the waste experts are being called upon to develop more sustainable methods of dealing with municipal waste. One step in improving the current solid waste situation is enhancing resource recovering activities. Recycling inorganic materials from municipal solid waste is often well developed by the activities of the informal sector. Reuse of organic waste material however, often contributing to more than 50% of the total waste amount, is still fairly limited but has interesting recovery potential. Coupled with approaches to reduce reliance on landfill as a disposal route, biological treatment is increasingly becoming adopted as a standard requirement for the vast majority of biodegradable wastes. This book deals with such urban organic municipal wastes from households, commercial activities, institutions, as well as gardens and parks. It describes approaches and methods of composting on neighbourhood level in small -and middle- scale plants. It considers issues of primary waste collection, composting methods, management systems, occupational health, product quality, marketing and end - user demands.

The existing physical plan and socio -economical situation of many cities in low -and middle -income countries strongly favours the implementation of decentralised composting systems.

- Decentralised composting systems are less technology dependent. Low cost, locally available materials and simple technology can be used.
- In contrast to decentralised composting systems, centralized options require technical machinery of high capital cost as well as high maintenance costs and a high degree of specialized skills is also required, and so they are prone to a higher risk of failure.
- Decentralised options are labour-intensive, generate employment and- given the low labour costs - are more cost-effective. Such options enhance income and job opportunity for the poor, socially deprived, informal workers and small entrepreneurs and provide ideal opportunities for public-private partnerships.
- Decentralised options are well suited for the waste stream, climate, and social and economic conditions of low - and middle-income countries.
- Decentralised waste management enhances and improves environmental awareness of the beneficiaries. Source-segregation by the residents reduces the volume of solid waste earmarked for disposal effectively and increases the value of recyclables.
- Decentralised systems reduce the cost incurred for the collection, transportation and disposal of waste by the municipal authority.

This manual serves to create and contribute towards an enabling environment in order to promote, replicate and strengthen decentralised composting worldwide.



François Muenger  
Senior Water and Sanitation Advisor  
Swiss Agency for Development and Cooperation (SDC)

---

## Table of Contents

|  |    |
|--|----|
| <b>Introduction</b>  | 7  |
| <b>Launching a Collection and Composting Scheme</b>                            | 9  |
| Activity 1 Determine the opportunities and threats for your composting project | 9  |
| <b>Task 1 Identifying Stakeholder Interests</b>                                | 13 |
| Activity 1 Identify project stakeholders                                       | 13 |
| Activity 2 Identify environmental legislation and land use regulations         | 14 |
| Activity 3 Identify potential marketing options                                | 15 |
| <b>Task 2 Assessing Target Community Interests and Land Availability</b>       | 19 |
| Activity 1 Organise a community meeting  | 19 |
| Activity 2 Conduct a structured survey using a questionnaire                   | 20 |
| Activity 3 Assess land availability and visit proposed sites                   | 21 |
| <b>Task 3 Data Collection</b>  | 25 |
| Activity 1 Determine the solid waste generation                                | 25 |
| Activity 2 Analyse the solid waste composition                                 | 26 |
| Activity 3 Assess topography and road conditions                               | 27 |
| <b>Task 4 Preparing a Business Plan and Financial Projections</b>              | 31 |
| Activity 1 Develop an appropriate management model                             | 31 |
| Activity 2 Determine the viability of the project: Benefit - Cost Analysis     | 34 |
| Activity 3 Develop the contract for involved partners                          | 38 |
| <b>Task 5 Development and Design of Collection System</b>                      | 41 |
| Activity 1 Select the most appropriate vehicles                                | 41 |
| Activity 2 Select the appropriate waste collection system                      | 43 |
| Activity 3 Calculate the number of vehicles required                           | 44 |
| Activity 4 Community participation and mobilisation for waste collection       | 44 |
| Activity 5 Organise and introduce fee collection                               | 45 |
| Activity 6 Try to promote source segregation                                   | 45 |
| <b>Task 6 Design and Construction of Composting Facility</b>                   | 49 |
| Activity 1 Plan and decide on the composting plant layout                      | 49 |
| Activity 2 Plan the required key features                                      | 50 |
| Activity 3 Plan staffing requirements  | 54 |
| Activity 4 Plan additional equipment and expendables                           | 54 |
| <b>Task 7 Operating and Maintaining a Composting Facility</b>                  | 57 |
| Activity 1 Operation and monitoring  | 57 |
| Activity 2 Trouble shooting  | 66 |
| Activity 3 Control the quality of compost                                      | 67 |
| <b>Task 8 Marketing of Compost</b>   | 71 |
| Activity 1 Assess potential customers and competitors                          | 71 |
| Activity 2 Develop a marketing strategy  | 71 |
| Activity 3 Define your product   | 73 |
| Activity 4 Create a market map   | 75 |

---

## Annex

|                 |  |     |
|-----------------|--|-----|
| <b>Annex 1</b>  | <b>Overview - Timetable for Planning and Implementation</b>  | 81  |
| <b>Annex 2</b>  | <b>Basics of Statistical Analysis for Community Surveys</b>  | 82  |
| <b>Annex 3</b>  | <b>Questionnaire for Community Surveys</b>   | 83  |
| <b>Annex 4</b>  | <b>Layouts of Two Composting Plants</b>  | 85  |
|                 | 4A: Windrow- composting system, layout plan  | 85  |
|                 | 4B: a) Box- composting system, layout plan   | 86  |
|                 | 4B: b) Box- composting system, cross section view  | 87  |
|                 | 4C: Details of box composting system   | 88  |
| <b>Annex 5</b>  | <b>Template for Both a Memorandum of Understanding (MoU) and a Final Contract Between the Involved Parties</b> | 90  |
| <b>Annex 6</b>  | <b>Analysis of Waste Generation and Physical Composition as Conducted by Waste Concern in Bangladesh</b>       | 93  |
| <b>Annex 7</b>  | <b>The Science of Composting</b>   | 98  |
| <b>Annex 8</b>  | <b>Compost Quality Standards</b>   | 100 |
| <b>Annex 9</b>  | <b>Templates for Compost Monitoring</b>  | 101 |
|                 | Template 1 Monitoring Table for Single Windrow   | 101 |
|                 | Template 2 Temperature Monitoring Table for Several Windrow (in °C)  | 102 |
|                 | Template 3 Temperature Graph for Composting  | 103 |
|                 | Template 4 Final Quality Control Sheet for Compost   | 104 |
| <b>Annex 10</b> | <b>Preliminary Compost Application Guide</b>   | 105 |
| <b>Annex 11</b> | <b>Definitions and Glossary</b>  | 106 |
| <b>Annex 12</b> | <b>Authors and Reviewers</b>   | 108 |

## Introduction

*All human actions have one or more of these seven causes: chance, nature, compulsion, habit, reason, passion, and desire. (Aristotle)*

Solid waste generation and management is an issue of increasing concern in many developing countries, as it is one of the most immediate and serious environmental problems confronting local governments. Waste, if just dumped on a landfill site, is a misplaced resource causing further environmental problems. Integrated waste management focuses on recycling and reuse of different waste types: biodegradable waste composting is but one option. However, experience has shown that many composting schemes have failed in the past on account of inappropriate technologies, lack of markets for the product and weak business models. In Europe legislation has already proceeded as far as to restrict biodegradable waste disposal to landfill sites. These landfill directives compel actions towards an integrated organic waste management, in which composting and biogas production from organic waste play an important role. Upcoming environmental legislation in developing countries also allow the development of clear organisational structures, formation of verified partnerships and application of business models which are favourable to composting schemes.

### This handbook

- provides assistance in setting up decentralised composting schemes to mitigate the problem of municipal organic solid waste management in cities of developing countries,
- is mainly concerned with systems suited to neighbourhoods - primary waste collection systems and composting plants with capacities up to five tons per day,
- provides insights into the prevailing challenges of decentralised composting schemes, and recommends measures to avoid such problems through improved strategic planning, organisational, institutional, and operational procedures.

This document benefits largely from the experience of *Waste Concern*, a research-based NGO in Dhaka, Bangladesh. Experience, which is derived from nine years of operation of a community-based pilot composting plant in Dhaka, as well as the initiation and support of 38 replications in 18 towns in Bangladesh by February 2005. Waste Concern's experience reveals that community-based composting plants can be financially viable and sustainable provided that:

- a) legal and institutional conditions for establishing such schemes are considered,
- b) suitable financial and management models are taken into account, and
- c) appropriate technologies are applied and a sound operation ensured.

*Sandec* (Water and Sanitation in Developing Countries), a department of the *Swiss Federal Institute of Aquatic Science and Technology* (Eawag), complemented the experience of Waste Concern with more general research findings and specific data from other composting schemes of similar scale and nature in India, Indonesia, Sri Lanka, Vietnam, Burkina Faso, and Chile. Detailed information regarding specific cases is given in text boxes, and reference is made to further case study documents for each chapter.

This document attempts to synthesise the experience worldwide, and to provide guidance on key aspects the authors consider to be "generally valid". Mention should be made that this handbook is not a recipe to be followed blindly. Case-specific, local aspects, such as political and social systems, geography and climate, etc., should always be integrated in project planning. For a specific local city or country context, certain aspects and issues may obviously be more or less relevant, however, the needs have to be systematically analysed for each individual project – a fact that this handbook cannot take into account.

### Expected users of this handbook

This manual has been prepared for use by local non-governmental and community-based organisations (e.g. resident initiatives) and relevant persons in urban local governments. Private organisations or entrepreneurs interested in organic waste recycling may also benefit from this book. It may also help development agencies and other government sectors in planning waste management and composting programmes. It can be used as a basic source of information when negotiating with municipal authorities or advocating improved organic waste management strategies or policies.



## Structure of this handbook

This manual can either be read from beginning to end or used as guidance on specific topics. The reader is led step by step through the planning, implementing and operational stages of a decentralised composting scheme. The authors have tried to generalise to a certain extent the experience acquired. Special emphasis is placed on the following “Tasks”:

- Task 1: [Identifying Stakeholder Interest](#)
- Task 2: [Assessing Target Community Interests and Land Availability](#)
- Task 3: [Data Collection](#)
- Task 4: [Preparing a Business Model Plan and Financial Projections](#)
- Task 5: [Development and Design of Collection System](#)
- Task 6: [Design and Construction of Composting Facility](#)
- Task 7: [Operating and Maintaining a Composting Facility](#)
- Task 8: [Marketing of Compost](#)

Each “Task” is divided into a comprehensive section and activities to allow frequent success rating and progress assessment.

**The Annexes** contain further information on special issues, such as scientific aspects of composting, blueprints of facilities, contract templates, monitoring tables and guidelines.

The authors invite the readers to contact them for further information and clarification or to share their experiences on composting with them.

## Launching a Collection and Composting Scheme

*Strong reasons make strong actions. (William Shakespeare)*



Photograph 1.1: Common street scene in developing countries: micro dumps



Photograph 1.2: A vision becomes reality. Former micro dump has been converted into a small composting site

Before starting a composting initiative, you must have a clear vision of your objectives. If you have clear answers to the questions below, it will be easier to convince others to support your initiative. These questions may be asked by decision-makers or other stakeholders concerned with the project. Having clear answers available can help formulate a common vision with important stakeholders, thereby giving additional momentum to the start-up phase of a composting scheme.

What are the driving forces behind a new collection and composting scheme?

What do you strive to attain with the initiative? What is your vision?

- a clean neighbourhood?
- poverty alleviation?
- business opportunity and income generation?
- reduced environmental pollution and increased resource protection?
- improved soil and nutrient management?

Since the visions of initiators may vary, general project design considerations are necessary. Seeking clear answers to the aforementioned questions is the first and foremost step to successful implementation of a composting project. A vision can be formulated on the basis of available information of the current solid waste and prevailing environmental situation.

- Should the project comprise solid waste collection **and** composting, or should it concentrate on composting alone?
- From which partners and types of partnerships could the project benefit?

### Knowing your environment

The composting scheme will always be embedded in a complex and rapidly changing environment impossible to control and difficult to predict. However, the better your understanding of the external factors influencing your initiative, the better you can adapt and react to changes. Figure 1.1 lists some of the external factors influencing a business or project environment. These can easily be adapted to a composting initiative.

### Activity 1: Determine the opportunities and threats for your composting project

The “windows of opportunities” method allows collection and analysis of the external and internal factors influencing your initiative. Recollect the past in relation with the factors listed in Figure 1.1 and determine their influence on your decisions or initiative. Which external factors have led to your success, and which have caused failures?

Such a past-oriented analysis allows predicting possible future forces and their effects on composting and compost sales. Which forces are opportunities and which threaten your initiative? Bearing all these forces in mind, find ways to influence them to your advantage. Determine their influence on your business and develop scenarios on how to adapt and react if they come into play.

Copy the matrix of figure 1.2 on a big sheet of paper and enter the factors that have influenced your business/ project in the past (left side). Which factors contributed to a success or a failure?

Then, fill in factors that may influence your business in the future (right side). Which of them are opportunities to the project, which ones threaten your project?

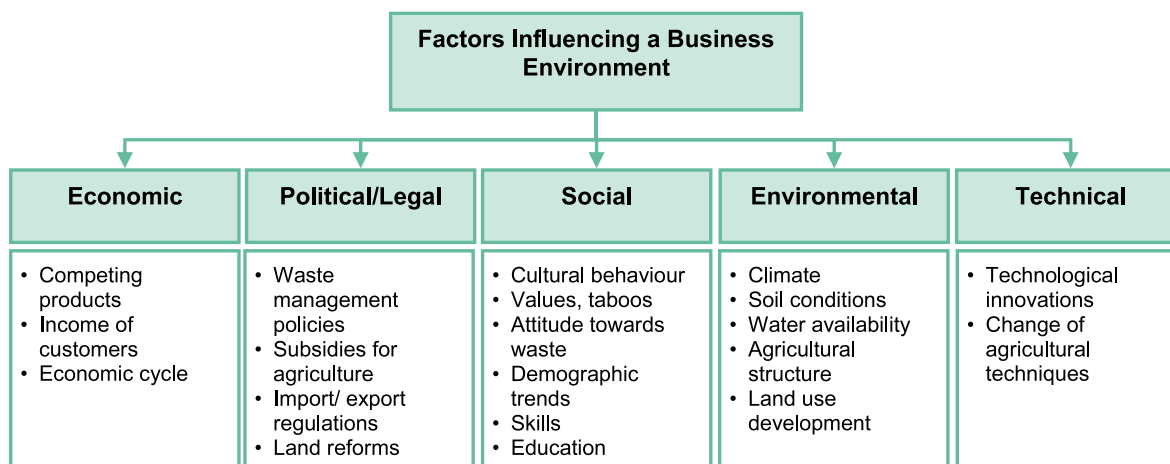
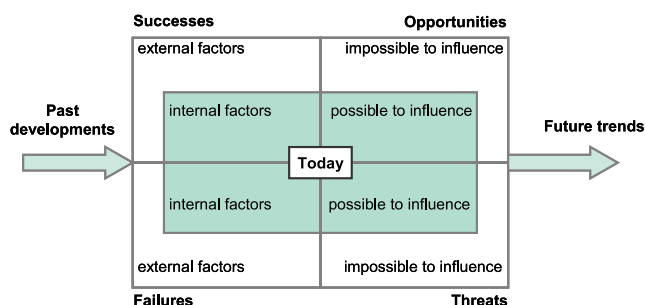

Figure 1.1: Factors influencing a business environment. These factors are hardly ever static but constantly changing. They may affect your business directly or indirectly

### Examples:

- Technological innovations: They strongly influence your project. Technical development can open up opportunities. Sound and appropriate technology ensures high quality of your product and long-term success of your project.
- Changes in farming practices: In the past most farmers adapted their practices after introduction and promotion of chemical fertilisers. Now, the application of compost requires a change of these practices, which implies a certain effort. This fact can be considered a threat, but it is a threat that can be reduced by certain activities. (e.g. through training courses)
- Climate is a natural force which may already have caused a failure of a composting project. (e.g. by heavy rainfall saturating the composting windrows). Such climatic condition may pose a threat. Although, you cannot change the prevailing climatic condition, you can adjust your technology (e.g. by roofing your composting site or providing a drainage system).
- Competing products: Cow dung or poultry manure may be competing products to compost, especially if they are abundantly available at a low price. Such competing products pose a considerable threat. Given such a situation it may be tough to influence the market unless you are able to provide compost at lower prices or with a better quality.



The following chapters provide guidance for project implementation with clearly structured tasks, explanations and activities. However, this handbook alone is not enough to convey the necessary skills needed. Communication skills, structured thinking as well as clearly defined objectives and a flexible strategy will certainly help to gain the support of other stakeholders.

Figure 1.2: Matrix to evaluate factors which determine success, opportunities, failures or threats of a business or project. List any factor having an influence on your project today and order them according to the matrix

# Task 1



Identifying Stakeholder Interests

**Identifying Stakeholder Interests : Task 1**

Assessing Target Community Interests and Land Availability : Task 2

Data Collection : Task 3

Preparing a Business Plan and Financial Projections : Task 4

Development and Design of Collection System : Task 5

Design and Construction of Composting Facility : Task 6

Operating and Maintaining a Composting Facility : Task 7

Marketing of Compost : Task 8

## Task 1: Identifying Stakeholder Interests

### Partnership means sharing risks and benefits. (Anonymous)

For project implementation, it is essential for you to be informed about the stakeholders and their interests. The needs and aspirations of various stakeholders have to be identified. Their willingness to accept and participate in an improvement programme, involving waste collection and composting, will depend on the priority given to solid waste, awareness, and social cohesion of the community as well as on affordability and willingness to pay for the waste services rendered. All parties can benefit from a stakeholder analysis. Sound data from the beginning contributes to developing appropriate partnerships at a very early stage. Partnership also means the sharing of benefits and risks of a project, since awareness of the concerns and ideas of others may prevent many pitfalls on the way to a successful composting project.

Furthermore, to attain a long-term success and avoid legal proceedings from opponents and pressure groups, it is important to also consider the legislative framework (e.g. environmental laws and land use regulations).

After undertaking the three subsequent activities, you will be informed about:

- relevant stakeholders involved in your project
- potential project partners
- potential communities for project implementation
- potential composting sites in these communities
- potential risks for your project and possible mitigation strategies

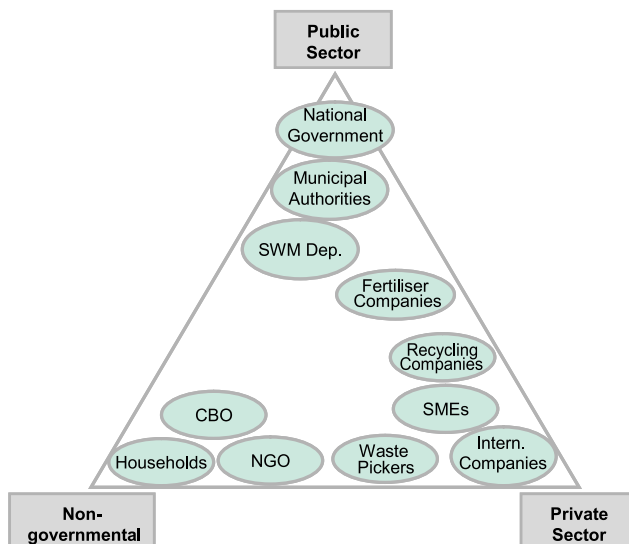

Figure 1.3: Triangular matrix for a first determination of potential stakeholders

### Activity 1: Identify project stakeholders

Municipal stakeholders will first have to be identified to assess their interests. A first overview of municipal solid waste management and responsible stakeholders may be obtained from secondary data such as newspapers and reports. A stakeholder analysis helps to assess the key stakeholders for project success, their roles and level of participation during project implementation and operation. It assists in understanding the different and conflicting interests, as well as the potential for cooperation and coalition with other stakeholders. A first overview can be obtained with an analysis like shown in figure 1.3. Stakeholders are identified and arranged in a triangular matrix showing the three important organisational sectors (private, public and non-governmental).

Table 1.1 contains a list of typical stakeholders, and the way to assess and compare them. This list does not claim to be exhaustive, as other stakeholders may be relevant in your specific situation. The potential **impacts** describe the positive (+) or negative (-) influence of a stakeholder on the project. By formulating these positive and negative influences in the column **Remarks** this table will already allow a first risk assessment.

Two strategies for collection of relevant information from stakeholders are briefly described as follows:

Firstly, the parties are invited to a meeting where the project is presented and upcoming questions are discussed and answered. Such an open discussion already reveals the interests and concerns of the different stakeholders. It is essential that all this information is treated with the same importance, and that all stakeholders are allowed to express their opinion. These statements should not be commented on by the initiator, as the objective of this meeting is to collect information and not to defend the idea behind the project.

Secondly, if not all stakeholders can be convened, consider individual meetings with selected stakeholders. Give a short presentation of your project and allow time for questions and answers. This is more time-consuming but contributes to a more effective information exchange. Stakeholders may give important hints regarding project development or name other helpful organisations and potential partners.

Table 1.1: Matrix for a stakeholder analysis

| Stakeholders   | What are their interests?<br>What are their concerns?  | Assess the potentially positive (+) or negative (-) impacts | Remarks |
|--|--|---|---------|
| Ministry of the Environment                                | Reaching targets   |   |         |
| Elected local representatives                              | Timely delivery of visible services  |   |         |
| Municipal authority (waste department)                     | Reaching targets<br>Operational control  |   |         |
| Municipal department responsible for parks and green areas | Treating the park trimmings<br>Using the compost   |   |         |
| Fertiliser associations                                    | Promoting fertiliser<br>Developing new products  |   |         |
| Community organisations                                    | Improved access to SWM services<br>Improved health and opportunities<br>Financial burden                 |   |         |
| Women and children in the communities concerned            | More time for other activities<br>Job opportunities  |   |         |
| Men in the communities concerned                           | Improved health<br>Job opportunities   |   |         |
| Waste pickers and sweepers of the informal sector          | Decreased access to recyclables<br>Job opportunities   |   |         |
| NGOs / CBOs  | Improved hygiene situation<br>Job opportunities for the poor<br>Improved well being in the neighbourhood |   |         |
| Donor agencies   | Short-term disbursement of funds<br>Visible poverty alleviation  |   |         |

Waste Concern has developed a list of **ten main questions** relevant to launching a composting scheme. These questions need to be answered by all stakeholders. The list of questions below can also provide guidance to both the mixed stakeholder meeting and the individual meetings.

- 1. Collection:** Does a primary house-to-house collection exist in the municipality?
- 2. Source Segregation:** Are the stakeholders familiar with any waste segregation initiatives?
- 3. Support:** Does the municipality show commitment to waste management projects?
- 4. Land Availability:** Is land for a composting site available in the urban areas?
- 5. Road Conditions:** How are the road conditions in the proposed areas?
- 6. Community Awareness:** Is the community aware of waste management problems?
- 7. Knowledge:** Do the stakeholders know of any composting activities or technologies?
- 8. Composting Experience:** Are persons or institutions already familiar with composting?
- 9. Compost Demand:** Is there a potential demand for compost and by whom? What fertilisers are used? Is compost already sold? Are marketing activities available?
- 10. Data Availability:** Do stakeholders have reliable data on the amount of waste generated and its composition?

## Activity 2: Identify environmental legislation and land use regulations

Since national regulations vary significantly, they need to be examined on a case-by-case basis. Prior to starting a composting project, the laws and regulations that might influence the project, need to be examined thoroughly to avoid delays or even cancellation of the project. If necessary, seek advice from a lawyer, an NGO or the municipal authorities.

- Environmental laws – Determine the existence of a general legislation supporting or prohibiting waste recycling and reuse.
- Solid waste management rules and regulations – Determine the existence of a general guidance supporting or prohibiting waste recycling and reuse.
- Land use regulations and urban planning strategies – Determine the existence of regulations regarding the construction and operation of waste treatment plants. In some cases, the setting up of such plants in residential areas is prohibited.
- Agricultural laws – Determine whether agricultural waste reuse is regulated in any way (e.g. quality certificates, reuse limitations, pollution control).
- Trade laws and regulations – you may have to register the product if you want to market compost.

### Activity 3: Identify potential marketing options

This activity is only the first step of the development of a marketing strategy for compost. Though Task 8 (Marketing of Compost) is at the end of this book, we recommend reading it after finalising this Task. Task 8 introduces the 4 Ps of marketing (Product, Price, Place, and Promotion) and provides additional structured information how to analyse markets and elaborate a strong marketing strategy. This knowledge should be kept in mind when reading the following chapters of this handbook.

The main objective of a waste collection and composting project is an environmentally friendly and socially acceptable removal of waste. Composting is one treatment option among many, and only viable if a sound financing system is guaranteed. Such financing systems may consist of subsidies, user fees, and income from the sale of compost or a combination of all the options mentioned. However, the demand for compost is of key importance. There are many markets for compost beyond its typical use as soil amendment or fertiliser. However, identification of these markets and how they should be approached have to be thoroughly clarified. At this stage of the project, only general questions on the potential marketing options need to be answered to determine whether composting can be a financially viable project.

Different customers and marketing options for the final products of the composting scheme should be identified during stakeholder analysis. A composting scheme can have revenues from the sale of compost and recyclables, and potential incomes from both sources need to be assessed. A market study is not difficult to conduct but requires some planning and time. You need to collect information on:

#### A. Your existing customers and potential customer groups

to maintain and improve your product and service, to guide your promotional efforts and develop new compost products or new services (e.g. delivery, advice on use).

#### B. The competition and competing products

to help you assess the probabilities of success and failure, give you ideas to improve your products and/or services, and find a way to increase your share of the market or to reach other customer groups.

#### C. The environment

comprising economic, social, political, and natural forces influencing the composting business. Collecting information on the environment allows you to stay abreast of and respond to particular trends or events affecting your business. Awareness of a drop in interest rates or new waste management policies is important to assess their positive or negative effects on your business.

The information necessary for your analysis can be collected from two main types of data sources:

- **Primary sources**, providing firsthand information, originate from key informants such as existing and potential customers, competitors, decision-makers or experts. Although collection of this kind of data can be costly and time-consuming, it can also be the most valuable, as it is the most up-to-date and specific information you can obtain.
- **Data from secondary data sources** has already been collected by others. It originates from trade journals, government publications, statistics, reports from local and external development agencies or NGOs or even surveys conducted by other companies. This data can provide valuable information on your customers' needs and business environment.

**Potential customers** must either need or want (or both) compost, and be capable and willing to pay for it. Mention should be made that not all these components are necessary to qualify for a potential customer, however, the ability to pay for compost is essential.

- Where could compost potentially be used and for what?
- Who are your potential customer groups and what are their compost needs?
- What assumed potential quantities might each customer group need (potential market demand)?
- How much are they able and willing to pay?
- What are the existing alternatives to compost and how much do they cost (e.g. manure, soil, sludge)?

Prepare a list of potential customers and visit them. Investigate their needs regarding compost quality and quantity required, as well as their willingness to pay. The following box contains an overview of potential customer groups known to require compost. The customer groups can be divided into bulk markets which demand high amounts and are not willing to pay high prices and cash markets which pay higher prices but require less amounts of compost. However, the list is not complete, since the local context may reveal several additional niche markets.

#### Typical compost customer groups

##### Bulk market

- urban and peri-urban agriculture (farmers)
- rural agriculture
- viticulture (wine)
- green space management (parks, zoos, sport arenas)
- forestry
- landfill rehabilitation, mining rehabilitation

##### Cash market

- horticulture (flowers and trees)
- home gardening
- vegetable gardening
- hotels and company premises
- landscaping, land development
- fertiliser companies (retailers)
- industrial use (biofilters)



Figure 1.4 shows average compost market figures from Switzerland. In this case, agriculture demands 67% of produced compost and is the main market for compost. However, compost has a low value in the agricultural sector and only little profit can be gained.

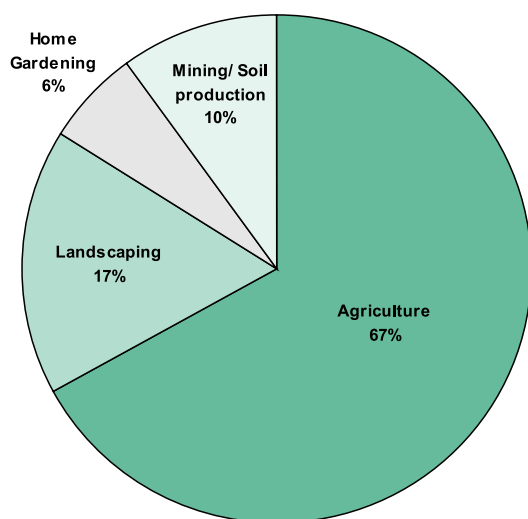

Figure 1.4: Average distribution of compost to different customer groups. Assessment of 13 Swiss compost producers (from Schleiss (2002): *Compost Marketing in Switzerland*)

An example of how to characterise a potential compost customer group is given in table 1.2, with focus on the horticulture market segment in an urban setting. It describes its compost use and most typical requirements regarding compost quality and quantity. Such fact sheets for each

Table 1.2: Example of a compost customer fact sheet

| Customer Group: Horticulture/Nurseries |  |
|--|--|
| <i>Geographic location</i>             | Urban and peri-urban area, frequently along roadsides and on vacant plots.   |
| <i>Uses</i>                            | Compost is used as soil substrate and potting mixture for container plants such as trees, flowers, ornamental plants, and seedlings.   |
| <i>Quantity</i>                        | As aforementioned, compost alone is not recommended for use as soil substrate, however, mixed with sand and/or soil it gives an excellent potting mix. Potting soil typically is amended with 5-40% of compost (by volume).                            |
| <i>Quality</i>                         | Seedlings require well-matured and finely sieved compost. Less mature compost can be used as mulch for adult plants.   |
| <i>Ability to pay</i>                  | This customer segment usually draws a regular but not necessarily high income from a continuous and reliable market. Thus, the ability to pay is assumed to be average.  |
| <i>Willingness to pay</i>              | Willingness to pay is dependent on the level of awareness and knowledge on how to use compost. Self-made compost by the nurseries or animal manure may compete with your product and reduce willingness to pay.  |
| <i>Purchasing behaviour</i>            | Seasonal fluctuations in purchase are generally expected.  |
| <i>Competing products used</i>         | Self-made compost, animal manure, peat, subsoil.   |
| <i>Estimated potential</i>             | X number of nurseries have been identified in the city. The annual demand of a nursery is estimated at Y tons of raw compost. Data is based on local business statistics and own observations. (multiply the X value with the average of all Y values. |

customer group can be established from your stakeholder analysis. They constitute the basis for assessing the overall potential market demand.

Consider your own situation and think whether compost could either be sold by your own distribution network or through retailers, which take over distribution of the product (e.g. a fertiliser company). In the latter case, the partner would be the bulk customer of the composting scheme. In some cases, the end user could also be a bulk customer, e.g. if the municipality is interested in the product and willing to pay for it. Both strategies have inherent advantages and disadvantages. The decision is strongly dependent on compost demand and location of the different potential customer groups.

With this information, it is possible to judge if a composting scheme is feasible in your local context. All potentials and risks influencing the project should be known to allow development of mitigation strategies to tackle potential risks. Be aware that markets are very dynamic. It is crucial for a business to keep track of market developments in order to remain competitive.

The current conditions may sometimes be unfavourable for setting up a composting scheme, such as the lack of demand for compost due to the availability of other cheaper fertilisers, constant water shortages or lack of land. In such cases, other waste management options must be developed.

Now, you are invited to have a closer look at Task 8 of this handbook.

## Task 2



Assessing Target Community Interests and Land Availability

Identifying Stakeholder Interests : Task 1

**Assessing Target Community Interests and Land Availability : Task 2**

Data Collection : Task 3

Preparing a Business Plan and Financial Projections : Task 4

Development and Design of Collection System : Task 5

Design and Construction of Composting Facility : Task 6

Operating and Maintaining a Composting Facility : Task 7

Marketing of Compost : Task 8

## Task 2: Assessing Target Community Interests and Land Availability

### *Structures influence processes, processes change structures (Anonymous)*

After identifying the potentials, risks and relevant stakeholders and deciding to go ahead with the implementation of the composting activities, focus is placed on selecting the target community for the composting scheme. If the decision-makers propose several locations for the composting site, these should be visited and the project presented to the community and beneficiaries. The most appropriate way is to hold a question and answer meeting to allow all participants to state their opinions and concerns about the project (Task 1).

After finalising the subsequent activities you will be aware of:

- how to approach and inform the community
- how to evaluate the willingness of the community to participate in the project
- ideas and concerns of the beneficiaries
- local conditions in the target area
- community willingness to cooperate and to what extent
- important criteria required to identify potential composting sites in these communities.

To conclude, you know whether this community offers a suitable location for your composting scheme.

Participatory approaches have been widely applied in the fields of water, environmental sanitation, hygiene, and waste management. Experience has shown that community involvement can lead to wide-ranging benefits:

- If people understand a problem, they are more willing to solve it.
- Communities can and should determine their own priorities in dealing with the problems they face.
- People solve their own problems best in a participatory group process.
- The enormous depth and scope of acquired community experience and knowledge can be used to bring about changes and improvements.

Programmes with community involvement therefore aim at involving all members of a society in a participatory process of assessing their own knowledge, investigating their own environmental situation, visualising a different future, analysing constraints to change, planning for change, and implementing change. Their interest and motivation to participate and contribute influence the organisational setup of the project (see Task 4).

### **Activity 1: Organise a community meeting**

To establish a composting unit with community support, organise meetings in the community with the largest possible number of different stakeholders such as:

- Members of the community, male and female, as well as youth and children
- NGO representatives, active in this community
- Political and administrative representatives of the community
- Existing waste workers (collectors and recyclers) servicing the area
- Municipal waste management staff.

Announce a community meeting and invite all interested parties. Make sure that all the interested stakeholders are able to attend the meeting (see Table 1.2 (Matrix for stakeholder analysis) in Task 1). Openly discuss the advantages and disadvantages of the existing waste management system at the meeting.

- What problems have been identified in relation to waste management? What causes the problems? Who sees them as important?
- Do stakeholders see any opportunities and potentials for improvement of the waste management system?
- Is there a tradition of community-based action, and what are the opinions on this approach?
- Are primary stakeholders aware of the need to change the common practices with the new approach and technology?
- Which problems are seen as high priority? Do the priorities of stakeholders differ?
- Is composting a known practice? What information is necessary?
- Is land available within the community for the composting site in the community?

The next step is to present the scope and idea behind the project. Share the vision with the community but also inform them on how waste management and composting can be managed in practice. Describe the tasks and duties awaiting the community if a composting plant is set up. Allow questions and provide open answers and clear explanations. Do not defend the project, as it may show signs of weakness.

### Important Questions

Make sure the following issues have been raised during the meeting. Reflect on the answers voiced by the different stakeholders:

- Do community members have the required confidence and skills to engage effectively in participatory processes and partnerships?
- Are traditional institutional structures available, have they been used in the past and could they be used again? Will women be represented?
- Who makes decisions in the community, and how will local power structures be affected by the project?
- To what extent is the community interested in contributing labour and engaging in operation and maintenance? Will this affect its status? Will it contribute to its income?
- How will the project increase the responsibilities and workload of certain groups? Which groups need support and what kind?
- Will some groups be excluded from or negatively affected by the project (e.g. waste pickers?). How can this effect be overcome?
- Have all the target community members, particularly those affected by poverty or disadvantaged by their status in society, been able to voice their opinions?
- Have the different needs of women, men, older and younger people, and those with different abilities been taken into account?
- Have women and men expressed their views on the siting of the plant and possible institutional arrangements for operation and maintenance?
- Has the issue of financial costs for the households been raised?
- If user charges pose a problem for poorer households, what arrangements have been suggested to overcome this problem?
- Have women and men different responsibilities regarding household budgeting? Have they been taken into account when assessing willingness and ability to pay?

Independent from the organisational set up, the responsibilities and roles of the local community should be clarified. Experience reveals that a committee selected by the attending community members helps to establish ownership and responsibilities in the community.

#### The committee

- will be the authority through which the community can present its ideas and objections during project implementation and operation.
- will subsequently discuss all issues with the project coordinator and/or service provider and with the responsible municipal person to find a feasible solution.

- will determine whether the residents regularly pay their contributions for door-to-door waste collection.
- will determine whether the waste collectors perform their assigned jobs regularly and adequately.
- will also raise the environmental awareness of other community members.

If the community agrees to share the aforementioned responsibilities, go on to the next assessment step.

### Activity 2: Conduct a structured survey using a questionnaire

A community meeting, like the one previously described, is the first step to acquiring knowledge of the needs and priorities of the beneficiaries. This rather qualitative information has to be further quantified. This additional information (e.g. satisfaction with the current collection system or willingness to pay for an improved system) allows you to design your collection service and composting system. Remember that the first priority of the community is most probably a reliable waste collection service. If the community is satisfied with the service, it is far more likely to support additional measures like composting.

To obtain conclusive results regarding future system design and to avoid biased answers, the survey should cover a certain number of households randomly selected from among all income groups of the community. Furthermore, it is important to consider the gender issue. Make sure that you obtain a balance of women and men who are interviewed.

The calculation of the adequate number of households for a survey is quite complex and time consuming. Table 2.1 provides already calculated sample sizes under pre-defined sampling errors for household surveys. This table can give guidance on the number of households to be assessed to obtain reliable results. However, selection of sample size and acceptable sampling errors depend on the time and manpower available for such a study. For more background information about statistical analysis have a look at Annex 2.

Table 2.1: Calculation of adequate sample sizes for household surveys

| Total number of households in the community | Required sample size allowing a 95% confidence level |                |                  |
|---|--|----------------|------------------|
|   | Low  | Medium         | Still acceptable |
|   | sampling error                                       | sampling error | sampling error   |
| 100   | 50   | 50             | 49               |
| 250   | 152  | 110            | 70               |
| 500   | 217  | 141            | 81               |
| 750   | 254  | 156            | 85               |
| 1,000                                       | 278  | 164            | 88               |
| 2,500                                       | 333  | 182            | 93               |
| 5,000                                       | 357  | 189            | 94               |
| 10,000                                      | 370  | 192            | 95               |
| 25,000                                      | 378  | 194            | 96               |
| 50,000                                      | 381  | 195            | 96               |
| 100,000                                     | 383  | 196            | 96               |
| 1,000,000                                   | 384  | 196            | 96               |
| 100,000,000                                 | 384  | 196            | 96               |

If the total number of household lies between two given values, choose a sample size between the corresponding sample size values (interpolation).

The relevant questions for a household survey may differ from one case to another. Yet, the following nine questions provide guidance through this task. They can be revised and detailed allowing a categorisation of answers. Annex 3 shows a questionnaire for a community survey related to solid waste management.

1. Are you satisfied with your current solid waste management system (temporary storage and collection) in your community?
2. Does the municipal administration provide a solid waste management service in your area?
3. Do you think the current waste management system in the area pollutes the local environment?
4. Which factors (caused by inappropriate waste disposal) are responsible for local environmental pollution?
5. Who collects and disposes of your household waste?
6. What improvements of waste collection system would you like to see applied?
7. If your waste is collected directly from your house, how should it be collected?
8. How often and at what time do you want your waste to be collected?
9. You may have to pay a fee if your waste is collected directly from your house. How much are you willing to pay monthly for the system?

Analyse the completed questionnaire by counting the answers given and express them as a percentage of the total number of answers. If you did not have the means to do a comprehensive survey with the number of households suggested in Table 2.1 randomly divide the questionnaire in two groups and analyse them separately. If the results diverge from each other significantly, additional interviews are required. The box contains possible results of such a survey.

#### Example:

The results obtained indicate that 80% of the interviewed households feel that local pollution is caused by overflowing public bins as a result of the public emptying services not being frequent enough and a lot of waste is being left behind. The questionnaires also reveal that about 60% of the households interviewed favour a house-to-house collection, while 40% would prefer to place their bins in front of the house at a certain time. 90% of the households are willing to pay an additional fee for that service.

This information will allow you to adapt your project to community needs. Firstly, the collection must be improved. Secondly, composting will be justified, as it will clearly reduce the amount of waste in the temporary public storage and prevent them from overflowing. Thirdly, the results also clearly reveal that cooperation with the municipal workers is essential, as they are responsible for emptying the public storage bins and waste transportation. The households in the community will also judge your performance by the cleanliness of the area!

In some cases, the household-favoured system may not be clearly defined. Consult the “Committee” or invite the community to another meeting to discuss the results and jointly decide on a system. A consensus at this stage of the project avoids problems during implementation.

### Activity 3: Assess land availability and visit proposed sites

During the first community meeting, the important aspect of land availability has to be discussed with the attending stakeholders. Either the municipal decision-makers have already proposed plots or the community itself proposes land for the composting site. However, since land use, especially for waste treatment purposes in residential areas, is always a very sensitive issue, give special attention to that issue.

Given the often prohibitive prices of land in urban areas, it is essential to conclude special agreements to obtain this land at low rents or even free of charge. Ideally, the municipal authority should make land available as the future waste collection and composting services will contribute to

municipal service delivery. Experience shows that suitable plots of land can be found in almost all communities.

Listen to the proposals of the stakeholders, as they are familiar with the local conditions. However, the following areas are also worth a closer look if they have not been discussed already:

- privately owned land belonging to organisations
- unauthorised micro dump sites (which have to be cleared, but residents will appreciate a change)
- corners in a green area (park or strip along a road)
- unused public spaces.

Organise a visit to these sites with the stakeholders (municipal officers and/or Community Action Committee). During the visit, focus on the following important selection criteria and discuss them with the stakeholders.

- Proximity to the waste generation source to ensure frequent delivery of sufficient fresh waste at low cost. This is especially relevant when determining the number of staff and vehicles required for the waste collection service.
- Water supply is a prerequisite for a composting site. The water should meet the chemical quality standards (low in toxic compounds, heavy metals and salinity).
- An electricity supply is desirable as it facilitates some composting steps, however it is not essential.
- Sites should not be located at the edge of wetlands or flood plains.
- Roads for waste delivery and pickup of residues should be well maintained and easily accessible throughout the year.
- Densely populated neighbourhoods and areas where adjacent land users may object to a composting plant should be avoided.
- Adequate green buffer zones (for building a fence or planting trees), separating the composting plant from the neighbourhood should be available.
- Composting plants should be located downwind (considering the prevailing wind direction) from residential areas.
- The land of the composting site should be located on a slight slope and the soil should be appropriately graded to avoid water logging and facilitate proper drainage.

A composting plant with a daily capacity of three tons using a windrow composting system requires a site with an area of about 1000m<sup>2</sup>. A composting site using the box technique requires about 800m<sup>2</sup> of land. Task 6 (Design and Construction) will give detailed information on the most efficient way to set up the composting plant. However, it is important to consider the individual local conditions.

After finding an appropriate plot for the composting site, a written and signed agreement with the responsible persons should be established. Experience with existing decentralised composting plants has revealed that there will always be people who do not agree with the composting activities. The various reasons range from fear that nearby land will drop in value, fear of odour and vermin or other financial and political interests. Hence, a written agreement such as a Memorandum of Understanding (MoU) is important to ensure the continuity of the project. Formulation of the MoU strongly depends on local conditions and on the decision-makers. A generalised template for a MoU is shown in Annex 5. The template provides guidance on aspects to be mentioned and discussed. But it needs to be adapted to the particular local conditions.

### Further reading

GTZ (2005): Improvement of Sanitation and Solid Waste Management in Urban Poor Settlements, GTZ, Eschborn, Germany (order or download from [www.gtz.de/solid-waste-management](http://www.gtz.de/solid-waste-management))

# Task 3



Data Collection



- Identifying Stakeholder Interests : Task 1
- Assessing Target Community Interests and Land Availability : Task 2
- Data Collection : Task 3**
- Preparing a Business Plan and Financial Projections : Task 4
- Development and Design of Collection System : Task 5
- Design and Construction of Composting Facility : Task 6
- Operating and Maintaining a Composting Facility : Task 7
- Marketing of Compost : Task 8

## Task 3: Data Collection

*We can have facts without thinking but we cannot have thinking without facts (John Dewey)*

The activities of Task 2 have provided information on perceptions and needs of the community concerned, while Task 3 mainly concentrates on technical information necessary for the composting project. The data collection concentrates mainly on technical aspects of solid waste generation and management. One could argue that this technical information is also relevant from the start, but it is easier to obtain technical information if the local social relationships are well understood and first contacts established.

After finalising the activities of Task 3 you will be familiar with:

- the amount of waste generated in the selected community
- the waste components and other important waste characteristics
- the natural environment of your community

Knowledge of all these aspects is important when selecting the right waste collection vehicles and planning the design of the composting scheme.

### Activity 1: Determine the solid waste generation

If you are lucky, you will find reliable data on community waste generation in evaluation reports of NGOs, consultants or municipalities. In some cases, the information from neighbouring communities may also be relevant if the standard of living does not significantly differ from the one in the selected community. However, using “per capita” waste generation figures from secondary data along with average household size will be less reliable than information from first hand waste analyses. Secondary data is often of a more aggregate nature and does not include the local determining factors. Hence, it is advisable to conduct a own study for the target community.

The main questions to be answered are:

- How many households does the community comprise?
- How much waste is generated totally?
- What is the average daily waste generation rate of a household in the project area?
- How much organic biodegradable material is contained in this waste?
- How much recyclable material is contained in the waste? What types of recyclable material are present?

A direct measurement of the average household waste generation is necessary if such data is not available. A first rough estimate can be done by assessing the existing collection service, if already available. To obtain more

reliable information, the number of households (sample size) surveyed is equal to the sample size identified in Activity 2 of Task 2 (community survey). This activity requires additional time and staff and has to be planned thoroughly.

Organise a one-week survey of a sufficient number of households randomly selected in the community. Inform the households about the purpose of the survey and ask them to collect their waste in the bags or bins provided and collected by the survey staff. If possible, ask for municipal support and involve public workers in the study.

Prepare a short form, defining each surveyed household with an identification number, address and the number of household members. Ensure that each collected bag is labelled with the identification number.

Discard the waste on the first day without weighing it because you do not know how many days the waste has been waiting to be collected. If there is not a regular collection service is a good idea to discard the waste of the second day also because residents may be taking advantage of the collection service to clean out their yards. Include the weekend and at least one day before and after the weekend in case there is a significant difference in generation rate at the weekends.

Collect the waste bags from the households on a daily basis and take them to a central point where they are weighed separately. (Since the waste analysis continues with Activity 2, do not dispose of the waste!). Calculation of the average waste generation per household can be simplified by adding all the measured weights and dividing the result by the number of households (sample size). By dividing the result with the average number of household members you will obtain the per capita waste generation.

$$capwaste = \frac{\sum hhwaste}{hm}$$

*capwaste*: per capita waste generation (kg/ day)

*hhwaste*: average waste generation of one household (kg/day)

*hh*: number of households surveyed

*hm*: average number of household members

**Caution:** The survey merely reflects the waste generated by the community over one week only. Waste generation and composition may vary considerably depending on holidays or seasons. Though you can use the gathered information to go ahead with the project, it is advisable to conduct an additional survey during a different season.

### Future projections

The procedure for data collection and calculation focuses on the current situation. It is likely that the quantities of waste will increase in the coming years as the population rises and habits change. However, this change should not be of concern unless large numbers of people are moving into the neighbourhood. Annex 6 provides a brief introduction on how to calculate future projections.

After collecting all this information, you will certainly want to know how many households can be covered by the project. Given your planned composting plant size (e.g. three tons per day) and the aforementioned information, you can easily calculate the number of households covered by the plant.

$$hhs = \frac{\text{capacity} * 100}{\text{hwwaste} * \text{bio}}$$

|                   |  |
|-------------------|--|
| <i>hhs</i> :      | number of households serviced  |
| <i>capacity</i> : | intended plant capacity (kg/day)                                     |
| <i>hwwaste</i> :  | average waste generation of one household (kg/day)                   |
| <i>bio</i> :      | biodegradable fraction (% of household waste generation, wet weight) |

**Example:** Your aim is to set up a plant of three-ton organic waste processing capacity per day. Based on your survey, the average household waste generation rate is three kg per day with a biodegradable fraction of 75 %. Based on the following calculations, the number of households you will service is approx. 1330:

$$hhs = \frac{3000 * 100}{3 * 75} = 1330$$

Collection of additional organic waste from special waste producers (e.g. markets) will reduce the amount of households serviced by the given plant capacity.

## Activity 2: Analyse the solid waste composition

Waste characteristics can be generally divided into two groups:

- The **physical waste composition** provides information on waste contents such as organic and inorganic waste or recyclables. Furthermore, it includes moisture content and density. This information facilitates the decision on vehicle design or sorting efficiency.

- The **chemical waste composition** covers information on carbon and nitrogen content.

### 1. Analysing the physical waste composition

Determination of waste composition is conducted with the same waste like collected under Activity 1. However, it is not necessary to analyse the total amount of collected waste. Only 100 kg of waste is analysed. This amount is obtained through the so called quartering technique:

Pile the waste of all bags into a large heap and mix it thoroughly. Divide it into four quarters and keep just one quarter. If this amount is still too large, repeat the mixing and divide it again until only 100 kg of mixed waste are left. This representative sample is then sorted into three fractions, namely:

- organic waste (biodegradable waste)
- recyclables with market value (e.g. glass, plastic, metal)
- inorganic waste and residuals

Weigh the different fractions and calculate the relative municipal waste composition. Annex 6 provides examples of all these calculations. The examples base on an existing case in Bangladesh. Furthermore, it describes an alternative technique for reducing the waste to be assessed.

**Density** and **moisture** are two important waste parameters and need to be assessed. They are relevant for designing the collection containers and vehicles.

#### Density

Loosely fill the collected waste into a container of known volume (10–50 litre) and weight. Weigh the container and register the result. The density can be calculated using the following equation:

$$\text{density} = \frac{\text{container}_{full} [\text{kg}] - \text{container}_{empty} [\text{kg}]}{\text{volume} [\text{l}]}$$

Waste density in developing countries usually varies between 0.4 and 0.6 kg/l and is strongly dependent on the organic waste fraction and moisture. The higher the moisture or organic waste fraction, the higher is the waste density.

#### Moisture

Moisture can be measured rather easily: take a representative sample of the mixed waste collected (e.g. 10 kg) and register the weight ( $m_{start}$ ). Spread the waste on a plastic sheet in the sun and let it dry for 24 hours. Make sure that neither animals nor rain disturb the drying process. Reweigh the dried waste, register the result and let it dry for another 24 hours. Repeat the procedure until the weight is almost constant ( $m_{end}$ ). The loss in weight is equal to the

moisture content and can be calculated as follows:

$$\text{waterloss}[\text{kg}] = m_{\text{start}} - m_{\text{end}}$$

Calculate the moisture content by applying the following equation:

$$\text{moisture}[\%] = \frac{\text{waterloss}[\text{kg}]}{m_{\text{start}}} * 100$$

Significance of the moisture content for composting is explained in Task 7.

## 2. Analysing the chemical waste composition

Now focus is entirely placed on the organic fraction of the sorted waste. In an efficient composting process, the carbon/nitrogen ratio of the waste should range between 25:1 and 40:1. This variation indicates a possible variation in waste compositions. Carbon (C) and nitrogen (N) measurement of the organic waste fraction is expensive and requires professional equipment and knowledge. Initiators are often unable to finance such expensive preliminary analysis. This handbook will thus provide guidance on how to assess the C and N content through visual examination. The table below contains examples of organic waste and their typical range of C/N ratio.

Table 3.1: Waste types and their C/N ratios

| Waste Type  | C/N Ratio* | “Green” High in Nitrogen | “Brown” High in Carbon |
|---|------------|--------------------------|------------------------|
| Cow/chicken manure                                | 2-4        | X                        |                        |
| Vegetable waste                                   | 11-13      | X                        |                        |
| Grass cutting                                     | 15         | X                        |                        |
| Fruit waste                                       | 20-49      | X                        |                        |
| Household waste                                   | 34-80      | X                        | X                      |
| Leaves  | 40-80      |                          | X                      |
| Park waste: twigs/ branches, wood chips, saw dust | 200-800    |                          | X                      |

\* read: C/N ratio ranges from 2:1 to 4:1

On the basis of this table, characterise type and amount of waste surveyed in the target community. Household waste mainly contains kitchen and garden waste. As shown in the table, the C/N ratio of this waste is often already ideal for composting. However, in some cases or during certain seasons, the incoming organic waste either needs a carbon or a nitrogen supplement prior to composting. Task 7 (Operation and Maintenance) and Annex 7 (Science of Composting) provide additional information on waste mixing ratios.

## Activity 3: Assess topography and road conditions

The choice of waste collection vehicle is also dependent on local topography and road conditions. No general recommendations are possible as the choice mainly depends on the local conditions and cultural backgrounds. However, the following three examples illustrate the importance of that issue:

- If the community is located in a hilly area, handcarts and rickshaws are unsuitable as the loaded vehicles become too heavy for the collectors. This is especially relevant if the composting site is uphill from your community.
- If the settlement structure is very scattered, a motorised rickshaw bridges the collection distances much faster than a handcart.
- If the roads are not paved but merely covered with sand, the wheels have to be stronger and wider. This simple measure avoids time losses due to stuck vehicles.

The types of vehicles used for transporting goods and waste already indicate the types of locally available vehicles. Further information on advantages and disadvantages of the different vehicles is provided in Task 5.

### Further reading

Agency for Environment and Energy Management (ADEME) (1998): MODECOM™ - A method for characterization of domestic waste. ISBN 2-86817-355-1

Agency for Environment and Energy Management (ADEME) (1998): MODECOM™ - A method for characterization of domestic waste. Addenda to the MODECOM™ methodological guide. ISBN 2-86817-355-X



# Task 4



Preparing a Business Plan and Financial Projections

- Identifying Stakeholder Interests : Task 1
- Assessing Target Community Interests and Land Availability : Task 2
- Data Collection : Task 3
- Preparing a Business Plan and Financial Projections : Task 4**
- Development and Design of a primary Collection System : Task 5
- Design and Construction of Composting Facility : Task 6
- Operating and Maintaining a Composting Facility : Task 7
- Marketing of Compost : Task 8

## Task 4: Preparing a Business Plan and Financial Projections

### *Taking calculated risks is quite different from being rash (George S. Patton)*

The data collected in Task 3 contributes to the development of an appropriate management model in Task 4. Furthermore, it also provides guidance on determining financial viability of the business or project and the setting up of a contract with potential project partners.

After finalising the activities under Task 4 you will have learned to:

- develop an appropriate management model to implement the composting project
- assess the financial viability of your project by calculating the benefit-cost ratio
- set up a contract or agreement with your project partners

### **Activity 1: Develop an appropriate management model**

There is a wide range of different solid waste management models and business partnerships. The four management models for decentralised composting schemes described in this book proved to be applicable in various countries. Their usefulness is, however, strongly dependent on local conditions and cultural backgrounds. All the models described are based on some degree of partnership between the municipality, the community and/or private entrepreneurs. Any partnership model applied should, however, be based on common objectives, balanced power, clear agreements, mutual trust and understanding. Therefore, make sure to crosscheck the models described before developing the most appropriate for your needs.

All models described below have in common the municipality's benefits from an overall cost reduction of their waste management activities (mainly transportation and disposal) through a more decentralised reduction and treatment of waste.

#### **1. Municipally owned – municipally operated**

Decentralised composting schemes of this kind are planned, implemented and operated by a municipal division. The schemes form an integral part of the existing municipal solid waste management system. The thrust for its implementation comes from an integrated municipal policy for improved urban solid waste management. Such a policy foresees a clean and hygienic urban environment as a result of the reduction or recycling of waste as close to its source of generation as possible. Cost recovery for the composting schemes is not a prerequisite, but desirable. The major aim is to achieve benefits for the entire solid waste management system by lower transport costs, improved landfill management and reduced quantities of waste to be handled. Furthermore, organic waste

transformed into compost can contribute to generating a certain income for the city. Although this model assumes that decentralised composting is managed entirely by a dedicated municipal team, cooperation with residents is indispensable.

#### **2. Municipally owned – community operated**

In this model, the decentralised composting schemes are planned and implemented by the municipality, however, their operation and maintenance is handed over to the benefiting community. Ideally, the community is invited to come forward with own proposals and to participate in the planning and implementing processes. Apart from composting, this model often comprises primary waste collection and is frequently applied in low-income urban areas. In many instances, an intermediary, such as an NGO or a composting advisor, is required to provide or develop the technical composting and management skills within the community. The main incentive behind this model is to reduce secondary collection or transport costs by reducing and treating waste as close to its source as possible. Furthermore, it improves primary waste collection without significantly increasing municipal operation efforts and creates local employment opportunities. The operation and maintenance costs are covered by additional service charges paid by households and by the profits from the sale of compost. This model requires a written contract between municipality and community or, alternatively, with an NGO as intermediary.

#### **3. Municipally owned – privately operated**

As in the previous models the municipality plans and implements decentralised composting programmes. Composting plants are constructed on municipal land and the system is owned by the municipality. Operation and maintenance of these schemes is, however, contracted out to the private sector or NGOs by open bidding. The call for tenders already stipulates the rights and responsibilities of the future operator and forms the basis for a later contract between the partners. The contract regulates the duration of the arrangement, required maintenance, rents, sharing of profits, and waste collection fees. Operation and management costs have to be covered by the private contractor through the revenues of the project. The aim of such a project is to raise additional capacity in solid waste management (SWM) by involving third parties like the private sector, thereby contributing to additional know-how and finances to improve the entire solid waste management system. Depending on contract design and the local compost market conditions, this model has the potential to foster profit-seeking projects in SWM. Waste Concern promoted this model during a UNICEF-supported programme in 14 towns of Bangladesh. The municipality tendered primary waste collection and composting schemes in defined communities. The private operators received permission to use existing composting plants for five years



without paying rent or sharing the revenues from waste collection and composting. However, without the involvement of funding agencies, rental rules and regulations have to be included in the contract.

#### 4. Privately owned – Privately operated

This decentralised composting model is based on a profit-seeking approach, which presupposes that the income from waste collection fees and compost sale is sufficient to cover all the costs of a decentralised composting plant. Land and infrastructure are financed and managed by the private sector. However, if the private company still requires a permit to collect waste from defined municipal areas, it cannot act independently but has to conclude an agreement with the municipality. In Khulna, Bangladesh for instance, the private organisation *RUSTIC* constructed a composting plant on private land to process 20 tons of waste per day. The Municipality of Khulna granted a permit to collect waste from households and markets. Prior to the construction of the plant, *RUSTIC* had to apply for an environmental clearance certificate from the Department of Environment. A possible variation of this model allows a private entrepreneur to set up a composting plant on public land. Though the municipality provides the land, the full financial and operational responsibility remains with the private entrepreneur. The municipality grants a long-term lease for that land (e.g. ten years) to ensure a long-term operation and, thus, appropriate returns on investments.

Table 4.1 lists these models and briefly describes their advantages and disadvantages.

#### ALM – A municipal-community partnership in Mumbai, India

A slightly different example for a municipal-community partnership is found in Mumbai where the municipality has been successfully assisting neighbourhood schemes known as *Advanced Locality Management (ALM)*. The municipality of Mumbai supports community initiatives (involving groups of approximately 250 households each) to improve the living conditions in their own neighbourhoods. For many of them, waste management is a central aspect. The programme provides non monetary services to the active neighbourhoods. For example, the community advisor discusses community plans with the neighbourhoods and organises temporary cleaning equipment or designates abandoned open spaces as waste collection or composting sites. Of the 670 registered ALMs, roughly 280 collect and compost their organic waste. An additional fee paid by participating households finances waste collection, and the compost is, in turn, sold directly to the neighbourhood at a low price.

Table 4.1: Management models for decentralised composting

| Options  | Characteristics   | Main Actor(s)                            | Role of City Government or Municipality   | Advantages   | Constraints  |
|--|---|--|---|--|--|
| Model 1<br>Municipally owned -<br>Municipally operated | Integrated into the existing municipal SWM system and focused on reducing waste which otherwise has to be transported and disposed of in landfills.<br>Cost reduction through lower transport and disposal costs. | Municipality                             | Introduces recycling and composting into the SWM policy. Implementing agency.   | Composting is an alternative treatment system, which can be integrated into the existing system (waste collection, transport, disposal).<br>All composting sites can be centrally controlled.<br>City gains valuable soil conditioner to maintain parks and green areas.     | Financial constraints due to the low priority given to SWM projects.<br>Operating efficiency and marketing potential may not be fully exploited.<br>Lack of coordination between departments regarding the use of the compost product. |
| Model 2<br>Municipally owned -<br>Community operated   | Benefiting community is involved in the management of primary waste collection and composting.<br>Non-profit seeking model.<br>Cost reduction through lower transport and disposal costs.                         | Municipality<br>Local community<br>NGOs  | Introduces recycling and composting into the SWM policy. Implementing agency.<br>Supports communities in finding composting sites and develops a proper system for waste collection and disposal of residues.<br>Provides support funds for construction of composting plants and the setting up of a primary waste collection. | Alleviates the municipal burden of SWM through community inputs.<br>Improvement of solid waste management scope through voluntary participation.<br>Clear contracts ensure reliable partnerships with community groups.<br>Creates new jobs in the neighbourhoods.           | Lack of community awareness and interest.<br>Need for a reliable informal leader among the community.<br>Highly complex management.  |
| Model 3<br>Municipally owned -<br>Privately operated   | Benefiting community is partly involved.<br>Profit seeking model is possible. Requires at least full cost recovery (from fees and compost sales).<br>Cost reduction through lower transport and disposal costs.   | Municipality<br>Private sector or<br>NGO | Introduces recycling and composting into the SWM policy. Implementing agency.<br>Selects composting sites, constructs plants (investments); develops a proper system for waste collection and disposal of residues.<br>Contracts out the operation and maintenance. Monitors performance of contractors.                        | Alleviates the municipal burden of SWM through private sector participation.<br>Provision of additional funds and know-how through private investors.<br>Clear contracts ensure reliable partnerships with private entrepreneurs.<br>Creates new jobs in the neighbourhoods. | Lack of community awareness and interest.<br>Need for a reliable and skilled partner with sense of entrepreneurship.<br>Complex management.  |
| Model 4<br>Privately owned -<br>Privately operated     | Profit-seeking enterprise based on ideal compost market conditions. Income is generated through compost sale and collection fees.   | Private sector                           | Introduces recycling and composting into the SWM policy. Transparent regulations for public - private partnerships.<br>Cooperates in supplying raw waste and disposal of residues.  | Alleviates the municipal burden of SWM through private sector participation.<br>Provision of additional funds and know-how through private investors.<br>Clear contracts ensure reliable partnerships with private entrepreneurs.<br>Can create employment and business      | Lack of private land for composting activities.<br>Lack of vital compost markets if compost is not a well-known product.   |

## Activity 2: Determine the viability of the project: Benefit-Cost Analysis

The purpose of a benefit-cost analysis is to assess the financial viability of the composting scheme. This activity is very important for project planning. If a detailed benefit-cost analysis is done thoroughly as part of the feasibility study, appraisal is facilitated and potential financial risks can be determined. You should be conservative. All projects have certain risks and using too favourable assumptions can lead to a failure. If you have no experience with financial issues, ask for help to facilitate that activity.

The benefit-cost analysis should be undertaken only after a project is found to be feasible on technical, environmental and social considerations. The investments made on projects do not usually yield immediate return, as the return is generated over a number of years. Similarly, the costs incurred on the project may be spread over a number of years. Simply subtracting the costs from the revenues of each year does not allow a reliable judgement of the financial viability of the project over several years. There is the need for converting future costs incurred and revenues to be received to a common base called "present value". The net present value calculation (NPV) and the benefit-cost ratio (BCR) have proven to be suitable methodologies for determining the viability of composting schemes. The calculation of the BCR provides additional quantitative information on the viability of a project. The following methodology for NPV is derived and adjusted from *Jewell (An Integrated Approach to Business Studies)* and the *ADB Handbook for the Economic Analysis of Water Supply Projects*.

The financial benefit-cost analysis includes the following steps:

- (a) Set a time frame for your project (e.g. 5 -10 years)
- (b) Determine annual project revenues
- (c) Determine project costs
- (d) Calculate annual project net benefits
- (e) Determine the appropriate discount rate
- (f) Calculate the financial net present value (NPV)
- (g) Calculate the benefit-cost ratio (BCR)

To be able to calculate NPV and BCR, consult the results of the previous tasks and activities and link this information with actual or assumed costs and revenues. (For instance: the waste collection fees that residents are willing to pay, market prices for compost, costs of purchasing technical equipment, salaries, etc.)

**The calculation steps are illustrated by a simplified example of the benefit-cost analysis for a decentralised composting plant similar to those established in Bangladesh. It is assumed that the plant is managed by a private entrepreneur who uses his privately owned land and his own financial resources. The plant has the capacity to process three tons of biodegradable waste per day collected from 3400 households (approx. 3.5 tons incoming waste). Households pay a monthly**

**collection fee to the entrepreneur. Additional revenues are generated through the sale of compost. All investments are made in the first year before operation starts. The income and operation cost from year one are constant over the total project period of 5 years.**

### (a) Determine a time frame for your project (e.g. 5 -10 years)

In this example the project period is five years, which is determined by the contract between the municipality and the private entrepreneur. In other instances the project period can also be set according to the expected lifetime of the equipment.

### (b) Determine annual project revenues

The revenues are usually determined for each year of operation and for different revenue types. They are based on your market analysis and your marketing strategy (Task 1, Activity 3). The forecast of sales revenues is a critical factor in the calculation because it strongly influences the final result. Again, you should be conservative when estimating the sales revenues.

In the case of decentralised composting, usually, there are two typical revenue types: revenues from the sale of compost and revenues from waste collection fees. But there might be other income types such as income from the sale of recyclables or potted plants or income from carbon credits in the framework of the Clean Development Mechanism (CDM).

In this simplified case is assumed that the revenues are constant over the calculated period. (see Table 4.2) In a different case, the collection fees might increase over years or the number of households served might vary. In reality, the compost prices might also need to be adjusted to accommodate the market behaviour.

Table 4.2: Annual revenues of a decentralised composting plant processing 3 tons biodegradable waste per day

| Item   | Tk             | US \$        |
|--|----------------|--------------|
| Sale of compost 750 kg/day @ Tk. 2.5/kg (320 days/year)  | 600000         | 12000        |
| Monthly fee for house-to-house waste collection service from 3400 households @ Tk. 10/ household | 408000         | 8160         |
| <b>Total Revenues/ year</b>  | <b>1008000</b> | <b>20160</b> |

Note: 1 US \$ = Tk. 50

### (c) Determine project costs

It is necessary to differentiate between cost types to calculate the Net Present Value (NPV) or Benefit-Cost Ratio (BCR) for a new project. Investment costs usually occur at the beginning of a project, while annual operation costs go along with the daily activities. Financial sources for initial investments can be manifold, e.g. the municipal budget, development agencies or commercial loans. Depending on

the financing mechanism additional annual costs for repayment of loans and interest (capital costs) need to be considered in the calculation.

Operation costs are often divided into fixed costs (e.g. fixed monthly rents or repayments of loans) and variable costs (e.g. irregular maintenance costs, fuel, additives or electricity) but a detailed explanation of these aspects cannot be covered by this handbook. Further helpful literature is listed at the end of this chapter.

In this example the operating cost comprises all costs including salaries of waste collectors and workers, electricity and water, costs of additives and technical

maintenance. Table 4.3 (investment costs) and 4.4 (operational costs) show how costs can be determined and summarised. Capital costs are not considered in this example.

Note that this calculation does not consider costs for promotion and marketing of compost. You might need to consider additional cost for promotion campaigns, depending on the marketing strategy you follow. At the start of the project costs are higher than once a market is established. In any case, the costs for promotion should not be underestimated and need to be included in the budget of the annual operational cost of a composting plant (Table 4.4).

Table 4.3: Investment costs of a decentralised composting plant processing 3 tons biodegradable waste per day

| Item   | Tk             | US \$        |
|--|----------------|--------------|
| Purchase of land: 5 katha @ Tk. 150000/katha   | 750000         | 15000        |
| Construction of roofed sorting platform: 360 sq.ft @ Tk. 120/sq.ft   | 43200          | 864          |
| Construction of roofed composting shed with drainage facility: 2142 sq.ft @ Tk. 120/sq.ft  | 257040         | 5140         |
| Construction of office, bathroom, toilet and storage for recovered recyclables 120 sq.ft @ Tk. 500/sq.ft                                       | 60000          | 1200         |
| Construction of roofed screening area and packaging area: 95 sq.ft @ Tk. 120/sq.ft (additional 445 sq.ft are not roofed – no additional costs) | 11400          | 228          |
| Purchase of 3 rickshaw vans @ Tk. 15000/rickshaw van   | 45000          | 900          |
| Water & electricity connection   | 50000          | 1000         |
| Shovels, buckets, balance, protection gear, overalls for workers etc.  | 50000          | 1000         |
| <b>Total Investment Cost</b>   | <b>1266640</b> | <b>25332</b> |

Note: US\$1 = Tk. 50; 1 katha = 720 sq.ft.

Table 4.4: Annual operational cost of a composting plant processing 3 tons biodegradable waste per day

| Item   | Tk            | US \$       |
|--|---------------|-------------|
| Salary of 6 workers @ Tk. 2000/month x 12 months         | 144000        | 2880        |
| Salary of 3 van drivers @ Tk. 1500/month x 12 months     | 54000         | 1080        |
| Salary of 6 waste collectors @ Tk. 800/month x 12 months | 57600         | 1152        |
| Salary of plant manager @ Tk. 5000/month x 12 months     | 60000         | 1200        |
| Maintenance costs for equipment (annual)                 | 10000         | 200         |
| Electricity and water consumption (annual)               | 5000          | 100         |
| Additives for composting process (annual)                | 12000         | 240         |
| <b>Total Operational Cost</b>                            | <b>342600</b> | <b>6852</b> |

Note: US\$ 1 = Tk. 50

#### (d) Calculate annual project net benefits

The annual project net benefit is the difference between revenues and costs for each year. They are calculated for each year of the operation period. Table 4.5 shows the annual net benefits for the decentralised composting plant in US\$. The high costs at year 0 are the total investment costs of the project. As there are no revenues in that year, the annual net benefit is negative.

Table 4.5: Calculation of annual net benefits of a decentralised composting plant (calculation in US\$)

| Year | Annual revenues | Annual cost | Annual net benefit |
|------|-----------------|-------------|--------------------|
| 0    | 0               | 25332       | - 25332            |
| 1    | 20160           | 6852        | 13308              |
| 2    | 20160           | 6852        | 13308              |
| 3    | 20160           | 6852        | 13308              |
| 4    | 20160           | 6852        | 13308              |
| 5    | 20160           | 6852        | 13308              |

#### (e) Determine the appropriate discount rate

The annual net benefits shown in (d) do not present the real benefit of the project, as time is not considered. It is necessary to adjust the revenues and costs, which occur in the future. The method used for converting future cash flows (costs and revenues) to present value is known as **discounting**. Discounting future costs and revenues enables us to give them an appropriate weight in our present decision (see Box). Usually, the discount rate is determined according to the local interest rates for loans. The discount rate chosen should be close to the rate prevailing in the market to reflect the scarcity of resources.

##### Why discounting?

Suppose your friend offers you a US\$ 100 gift today or after one year. You certainly would choose to get the gift right away. There are different reasons for that: You may feel the risk that your friend may change his mind over the year, or you want to use the money now for buying some books or CDs you recently saw in a shop. You may even want to put the money to a bank account to gain interest for a later purchase. In all cases you have more benefits from the gift if you get it today rather than after one year. These examples show us that the value of money decreases with time. The longer you have to wait the lower is the present value for you.

The calculation of the present value (*PV*) is given by the formula:

$$PV = \frac{A}{(1+r)^n}$$

where

*A* is the annual revenue/cost

*r* is the discount rate (local interest rate)

*n* the year when the revenue/ cost occurs

The calculation of present values for a whole project is quite daunting. Therefore, practitioners developed discount factor tables, which can easily be used in the day-to-day work. The factor is calculated by setting  $A = 1$  currency unit, thus, the discount factors are applicable for all values of all currencies. Table 4.6 shows a selection of discount factors of different discount rates for periods up to seven years. As described above, the selection of the discount rate depends on the interest rates of the local market.

Table 4.6: Discount factors for selected discount rates

| Year | 6%     | 8%     | 10%    | 12%    | 14%    | 16%    | 18%    | 20%    |
|------|--------|--------|--------|--------|--------|--------|--------|--------|
| 1    | 0.9434 | 0.9259 | 0.9091 | 0.8929 | 0.8722 | 0.8621 | 0.8475 | 0.8333 |
| 2    | 0.89   | 0.8573 | 0.8264 | 0.7972 | 0.7695 | 0.7432 | 0.7182 | 0.6944 |
| 3    | 0.8396 | 0.7938 | 0.7513 | 0.7118 | 0.6750 | 0.6407 | 0.6086 | 0.5787 |
| 4    | 0.7921 | 0.7350 | 0.6830 | 0.6355 | 0.5921 | 0.5523 | 0.5158 | 0.4823 |
| 5    | 0.7473 | 0.6806 | 0.6209 | 0.5674 | 0.5194 | 0.4761 | 0.4371 | 0.4019 |
| 6    | 0.7050 | 0.6302 | 0.5645 | 0.5066 | 0.4556 | 0.4104 | 0.3704 | 0.3349 |
| 7    | 0.6651 | 0.5835 | 0.5132 | 0.4523 | 0.3996 | 0.3558 | 0.3139 | 0.2791 |

**(f) Calculate the financial net present value (NPV)**

Based on this information it is possible to calculate the net present value (NPV). The NPV is the sum of the **discounted** revenues minus the **discounted** costs. If the sum of discounted revenues exceeds the investments, then, the NPV is positive and the project is viable. Table 4.7 shows the calculation for the described example that we have been considering.

Table 4.7: Net present value calculation for a decentralised composting plant (calculation in US\$)

| Year              | Annual revenues | Annual cost | Annual net benefit | Discount factor (discount rate 16%) | NPV          |
|-------------------|-----------------|-------------|--------------------|-------------------------------------|--------------|
| 0                 | 0               | 25332       | -25332             | 1                                   | -25332       |
| 1                 | 20160           | 6852        | 13308              | 0.8621                              | 11473        |
| 2                 | 20160           | 6852        | 13308              | 0.7432                              | 9890         |
| 3                 | 20160           | 6852        | 13308              | 0.6407                              | 8526         |
| 4                 | 20160           | 6852        | 13308              | 0.5523                              | 7350         |
| 5                 | 20160           | 6852        | 13308              | 0.4761                              | 6336         |
| <b>Sum of NPV</b> |                 |             |                    |                                     | <b>18243</b> |

A positive NPV indicates a profitable project, meaning that the project generates sufficient funds to cover all costs and expected repayments under the assumed conditions. It can run independently and is expected to generate profits. The higher the NPV the more the profit that can be generated. A negative NPV indicates that a project is not financially viable under the assumed conditions. Such projects must seek for additional income (e.g. subsidies) or for cost reductions to become financially viable. Of course, the outcome of the NPV calculation strongly depends on the chosen discount rate. If the discount rate is high, the revenues must be higher to achieve a positive NPV.

**(g) Calculate the benefit-cost ratio (BCR)**

Finally, calculate the benefit-cost ratio. Similarly to the NPV, determine the discounted revenues and costs for each year

and add them up. Divide the sum of discounted revenues (a) by the sum of discounted cost (b) to determine the BCR. If the BCR is greater than one, the project is viable. The BCR partly quantifies the viability of the project. In the example shown in Table 4.8 the BCR is 1.38. That means investing 1 US\$ today, you will get 1.38 US\$ in return after five years.

Table 4.8: Benefit-cost ratio calculation for a decentralised composting plant (calculation in US\$)

| Year | Annual revenues | Annual cost | Discount factor (discount rate 16%) | Annual discounted revenues | Annual discounted costs | BCR = (a/b) |
|------|-----------------|-------------|-------------------------------------|----------------------------|-------------------------|-------------|
| 0    | 0               | 25 332      | 1                                   | 0                          | 25332                   |             |
| 1    | 20160           | 6852        | 0.8621                              | 17380                      | 5907                    |             |
| 2    | 20160           | 6852        | 0.7432                              | 14983                      | 5092                    |             |
| 3    | 20160           | 6852        | 0.6407                              | 12917                      | 4390                    |             |
| 4    | 20160           | 6852        | 0.5523                              | 11134                      | 3784                    |             |
| 5    | 20160           | 6852        | 0.4761                              | 9598                       | 3262                    |             |
|      |                 |             |                                     | <b>(a) 66012</b>           | <b>(b) 47767</b>        | <b>1.38</b> |

In any case it is advisable to repeat the calculation with changing variables in order to assess possible sensitivities of your calculation. For instance:

- vary the number of households who pay for the service or
- assume increasing salary costs over time or
- assume you have to take a loan and need to pay interest.

### **Activity 3: Develop the contract for involved partners**

Once you have selected the appropriate business model and have completed the benefit-cost analysis, you may get the approval to set up the decentralised composting scheme. It is crucial that the partnership is defined in the form of a memorandum of understanding or contract. In some countries, it is not common to sign contracts. Nevertheless, as long as private investments are involved, a contract provides a certain level of security. Furthermore, a contract clarifies the rights and duties of the relevant partners and helps to avoid future quarrels. The set up of contracts needs know-how and extensive negotiations among stakeholders. The sample contract shown in Annex 5 is derived from a case in Bangladesh and further generalised. It can act as guidance but does not claim completeness or applicability in all cases.

#### **Further reading**

Coad, Adrian (2005): Private Sector Involvement in Solid Waste Management – Avoiding Problems and Building Successes. Published by CWG – Collaborative Working Group on Solid Waste Management in Low- and Middle-income Countries (order: booklet with CD: [www.skat.ch](http://www.skat.ch) or full version: [www.gtz.de](http://www.gtz.de))

Asian Development Bank (1999): Handbook for the Economic Analysis of Water Supply Projects, Economics and Development Resource Centre. Though the focus is on water supply, many aspects are also relevant for SWM. (download from: <http://www.adb.org/publications/year.asp> - ADB Publications Catalogue)

Jewell, Bruce, R. (2004): An Integrated Approach to Business Studies. 4th Edition. Pearson Education Limited, Harlow, UK.

GTZ (2005): Improvement of Sanitation and Solid Waste Management in Urban Poor Settlements, GTZ, Eschborn, Germany (order or download from <http://www.gtz.de/en/themen/umwelt-infrastruktur/abfall/2841.htm>)

# Task 5



Development and Design of Collection System



- Identifying Stakeholder Interests : Task 1
- Assessing Target Community Interests and Land Availability : Task 2
- Data Collection : Task 3
- Preparing a Business Plan and Financial Projections : Task 4
- Development and Design of Collection System : Task 5**
- Design and Construction of Composting Facility : Task 6
- Operating and Maintaining a Composting Facility : Task 7
- Marketing of Compost : Task 8

## Task 5: Development and Design of Collection System

*Technology is dominated by two types of people: those who understand what they do not manage, and those who manage what they do not understand. (Putt's Law)*

After choosing the organisational setup of the composting scheme and partners, you can focus on technical aspects of the scheme. Guidance of this handbook now shifts from planning to implementation.

As mentioned several times in previous chapters, the success of a composting scheme is closely linked to successful waste collection. Customers (households) must be satisfied with the service provided. Waste should be collected daily or at least every alternate day to prevent odour emissions and facilitate waste separation.

Task 5 focuses on the waste collection system and then Task 6 reviews the composting system. You can skip Task 5 if you are in the comfortable position of already running a well-organised waste collection service or receiving the waste from a primary collection service for which you are not responsible.

After finalising the activities of Task 5, you will be informed about:

- the most appropriate vehicles and the number required
- how to ensure the participation and support of the community served
- how to promote waste segregation at source (in the household)

### Activity 1: Select the most appropriate vehicles

Selection of the most appropriate waste collection vehicles for a specific collection area is an important task. Well-designed waste collection vehicles contribute to increasing waste collection efficiency and collectors' safety. As mentioned in Task 2, several factors, such as topography, settlement structure or road conditions, have to be considered. Vehicles already used for transport of goods on the local market offer an indication of the types of vehicles which could be used for your collection scheme. Remember that your scheme will be responsible for primary waste collection. Activity 1 assumes that the composting plant will be located in or close to the area where the waste collection will take place. Thus the collection vehicles will generally be small and suited to the transport of waste for shorter distances.

During selection, the following aspects should be taken into consideration:

- Road conditions and settlement structure: The vehicles may have to travel through narrow lanes.
- Type of household waste collected: If the sand content is high, the container should be constructed with a strong grid instead of a closed metal sheet to allow the sand to fall out.

- Since waste can be corrosive and abrasive, ensure protective measures for metal surfaces (e.g. paint) particularly for containers.
- The volume of the vehicle is limited by waste density and travel distance. The denser the waste, the heavier it becomes! A person cannot push or pull the same load as a motorised vehicle, e.g. 2 m<sup>3</sup> waste of 0.5 t/m<sup>3</sup> density weigh 1 ton! This is already above the limit that a person can push or pull on most surfaces.
- The service area determines the volume and number of trips the vehicle has to cover.
- Select good quality vehicles even though they are more expensive. You will save money in the long run, as these vehicles need fewer repairs.
- Check the availability of spare vehicle parts on the local market. Place special attention to the wheels and bearings, as they are the most important part of the vehicle.
- Determine whether women or men are responsible for waste collection. Some vehicles may be unsuitable for women others for men.
- The storage containers of the vehicles should be covered to avoid the waste from falling out and protect it from excessive rainfall.
- If you promote source segregation, plan different compartments on your collection vehicle.



*Photograph 5.1: The manual handcart with a grid container and broad wheels was adapted to the local sandy road conditions and high sand fraction. The sand falls through the grid, thus reducing the weight of waste (AGRESU – GTZ GmbH, Maputo, Mozambique)*

Table 5.1 is compiled from various sources. It summarises different vehicle types and their characteristics.

Table 5.1: Comparative characteristics of waste collection vehicles

| Parameter             | Manual Handcart    | Animal Cart             | Rickshaw Van           | Tractor Trailer         | Fixed Bed Truck         | Tipper Truck            | Compactor Truck         | Container Truck   |
|-----------------------|--------------------|-------------------------|------------------------|-------------------------|-------------------------|-------------------------|-------------------------|-------------------|
| Range                 | < 2 km             | < 5 km                  | < 10 km                | < 15 km                 | Unlimited               | Unlimited               | Unlimited               | Unlimited         |
| Speed                 | Very slow          | Relatively slow         | Slow                   | Moderate                | Fast                    | Fast                    | Fast                    | Fast              |
| Road size suitability | Narrow             | Moderate                | Narrow                 | Moderate                | Wide                    | Wide                    | Wide                    | Wide              |
| Volume per vehicle    | 0.5 m <sup>3</sup> | 2 m <sup>3</sup>        | 2-3 m <sup>3</sup>     | 4 m <sup>3</sup>        | 8 m <sup>3</sup>        | 10 m <sup>3</sup>       | 12 m <sup>3</sup>       | 20 m <sup>3</sup> |
| Labour requirements   | 1 Collector        | 1 Driver<br>2 Labourers | 1 Driver<br>1 Labourer | 1 Driver<br>2 Labourers | 1 Driver<br>3 Labourers | 1 Driver<br>2 Labourers | 1 Driver<br>2 Labourers | 1 Driver          |
| Investment costs      | Very low           | Low                     | Low                    | Relatively low          | Moderately high         | High                    | Very high               | Very high         |
| Maintenance costs     | Very low           | Low                     | Low                    | Relatively low          | Moderately high         | High                    | Very high               | Very high         |
| Service life          | 5 years            | 5 years                 | 10 years               | 10 years                | 5 years                 | 5 years                 | 5 years                 | 5 years           |
| Trips/day             | 2                  | 2                       | 3                      | 2                       | 2                       | 4                       | 3                       | 3                 |

Source : Ogwa, 1988



Photograph 5.2: Rickshaw with front loader and containers in which waste is separated into three fractions (CEE Kalyan Nagar Residence Association, Bangalore, India)



Photograph 5.4: Horse cart capable of pulling up to eight rectangular containers (container exchange system) (Community Organisation, Agaki, Ethiopia)



Photograph 5.3: Rickshaw with a covered collection container and back doors (Waste Concern, Waste Collection and Composting Scheme, Mirpur, Dhaka, Bangladesh)



Photograph 5.5: Moto-rickshaw for long-distance waste collection. The tailboard is often higher to prevent the waste from falling out (CEE Kalyan Nagar Residence Association, Bangalore, India)

## Activity 2: Select the appropriate waste collection system

The outcome of the community survey should already reveal the collection system favoured and affordable by the community. Different collection models are possible:

- **House-to-house collection**

There are two basic types. In back-door or yard collection the waste collector enters the garden or courtyard and carries the waste bin to the collection vehicle. After emptying, the collectors return the bin to its original location. This method is not culturally acceptable in many places. In front door collection the collector rings the bell or sounds a signal outside and waste is brought out to him by a member of the household. This collection model is very effective and suitable for source segregation, but is also most labour-intensive and time-consuming. Furthermore, it requires at least one household member to be present during collection.

- **Block collection/Bell collection**

A vehicle follows a predetermined route at fixed intervals; it stops at selected locations where a bell is rung. Households bring out and hand over their waste containers to the collection crew.

- **Kerbside collection**

This type of collection system requires regular service and a fairly exact collection schedule. The households have to be instructed to put their (ideally closed) waste bin in front of their house just before the regular collection schedule. This will prevent rummaging by waste pickers or animals.

- **Communal collection bins**

This widely used system requires the households to bring their waste to a communal bin, which is emptied into large trucks. This system is inappropriate for composting as waste may be stored for over several days in the households before being brought to the container and so the waste becomes partly decomposed and compressed.

Table 5.2 is drawn from a UNCHS publication. It summarises and compares the different waste collection models.

No matter which collection system you choose, inform the households about its organisation and how they can contribute to its smooth and efficient operation. A regular and reliable waste collection service motivates many households to cooperate. Here the Community Committee (see Task 2) is an important communication partner. Motivation will generally lead to greater improvements than strict regulations or even threats of punishment, whose enforcement is beyond your competence. Hence, you rely on voluntary cooperation.

Table 5.2: Comparison of various solid waste collection models

| Description                                     | House-to-House Collection | Kerbside Collection | Block Collection | Communal Collection                |
|---|---------------------------|---------------------|------------------|------------------------------------|
| Householder cooperation in carrying refuse bins | No                        | Yes                 | Yes              | Yes                                |
| Householder cooperation in emptying refuse bins | No                        | No                  | Optional         | Yes                                |
| Need for scheduled service                      | Optional                  | Yes                 | Optional         | No                                 |
| Susceptibility to scavenging                    | None                      | High                | None             | Very high                          |
| Average crew size                               | 3-5                       | 1-3                 | 1-3              | 1-2 (portable)<br>2-4 (stationary) |
| Trespassing complaints                          | Yes                       | No                  | No               | No                                 |
| Level of service                                | Good                      | Good                | Fair             | Poor                               |
| Collection costs                                | Very high                 | High                | Medium           | Low                                |

Source: UNCHS (*Habitat*), *Refuse collection vehicles for developing countries*, p. 10, 1988



Photograph 5.6: House-to-house collection requires the presence of a household member (Waste Concern, Dhaka, Bangladesh)

### Activity 3: Calculate the number of vehicles required

How many vehicles are required to collect the waste in your service area? To be able to answer this question, some assumptions and calculations are necessary:

- Firstly, determine the volume your vehicle can carry. The aforementioned table provides guidance on this subject.
- Secondly, decide on collection frequency and model (daily, every alternate day, house-to-house, kerbside, block collection, street bin collection) as they influence the time required.
- Thirdly, assess time required for one collection team to fill the selected vehicle given a certain household density. This indicates the number of trips of one team per day. Add time required to travel from the composting plant to the collection area and back. A map of the community could be very useful here. Photograph 5.7 illustrates how a community organisation in Bangalore has structured the service area.
- Finally, calculate the number of collection teams necessary to cover the entire area. The calculation is based on the time required for each collection trip and the daily working hours of each collection team.

Table 5.3 will help to structure and calculate your data. It exemplifies the planning of a house-to-house waste collection system in a rather flat area. The following assumptions are the bases for the calculation:

Table 5.3: Example of the calculation of the vehicle demand

| Parameters                       |                             |
|----------------------------------|-----------------------------|
| Collection frequency & model     | daily, house-to-house       |
| Average waste generation         | 0.6 kg/cap = 3 kg/household |
| Waste density                    | 350 kg/m <sup>3</sup>       |
| Volume of vehicle                | 1 m <sup>3</sup>            |
| Collection time per vehicle      | 3 hours                     |
| Time to and from composting area | 15 + 15 minutes             |
| Coverage                         | 100 households              |
| Labour requirement (1 team)      | 2 persons                   |

#### Result:

**One team can cover two trips per day (8 hours). This is equal to a total of 200 households per day.**

|  |     |
|--|-----|
| Total number of households in the project area | 700 |
|--|-----|

#### Result:

|                                      |            |
|--------------------------------------|------------|
| Three teams can cover 600 households | too little |
| Four teams can cover 800 households  | too much   |

#### Final decision:

**Start with four teams to allow a reserve capacity and a certain operational flexibility.**

Experience also reveals that such a calculation provides only preliminary indication of the number of collection vehicles required. This calculation will certainly have to be adapted after the first operational experience. Be prepared to reorganise collection or to add an additional collection crew to the team.

Investment in an additional reserve vehicle in the event of a breakdown is highly recommended. Such breakdowns are very likely, especially if maintenance of the collection vehicles is neglected. Ensure frequent checks and maintenance of all moving parts. Check the condition of:

- bearings (greasing necessary?)
- wheels and handles (air pressure, fixed?)
- brakes (functional?)
- container (cleaning new point, necessary?)
- engine (if any)

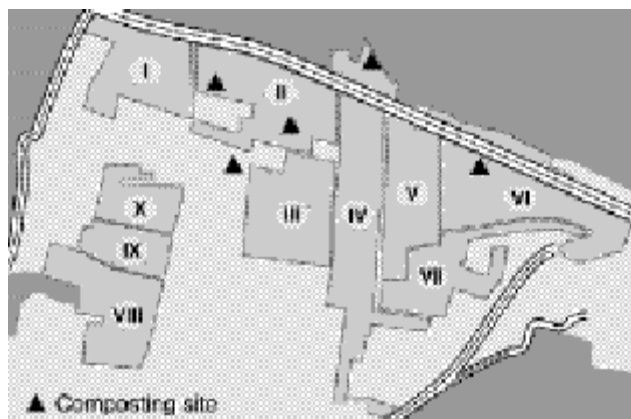

Photograph 5.7: Solid waste collection zones and routes in a municipal district of Bangalore (CEE, Bangalore, India)

### Activity 4: Community participation and mobilisation for waste collection

Since details on community participation and mobilisation could fill yet another book, this handbook provides merely some suggestions on how to mobilise the community. Further reading on community mobilisation is listed at the end of this section.

Community mobilisation for a waste collection and composting scheme generally aims at:

- raising the awareness of people regarding the benefits of a cleaner neighbourhood and compost production
- explaining how waste can be turned into a resource
- explaining how the scheme is organised and what each individual is expected to do
- encouraging people to come forward with ideas and initiatives, and to make complaints
- enhancing willingness of the households to pay for the new service

The results of the community survey in Task 2 provide an important basis for community mobilisation.

- Contact the community leaders and the Community Committee and inform them about the latest decisions and future objectives. Present the results of your survey and explain why a specific collection system will be applied.
- Contact households directly or during a community meeting using short and simple information leaflets. Inform them about the launching of the collection system, i.e., days and times they should expect the waste collectors. Distribute practical collection schedules for the households to display close to their waste bins.
- If the scheme creates new jobs, try to recruit the staff from among the community members, even if you have to provide additional on-the-job training. The more local people are involved, the more the new service will be accepted.

Community mobilisation is a never-ending job, as interest and participation have to be maintained through regular information. Beneficiaries tend to take the service for granted once it is established and smoothly running. Remind them of the efforts and work required to keep up the service and operation (e.g. inform the community at least once a year of the latest developments of the collection and composting scheme). School visits and open days may help to raise the local profile of the scheme.

### Activity 5: Organise and introduce fee collection

Studies have revealed that fee collection can be a tedious and time-consuming task. Inefficient fee collection, which can harm the viability of the collection and composting scheme, is mainly caused by the low level of acceptance of the scheme by the households. This clearly indicates the importance of a preliminary study and involvement of the community in the planning process. If the majority of the households are willing to pay, other households will follow. There will always be households stating that they are already charged for such a service and, therefore, refuse to pay additional fees. Others claim that they do not trust the fee collectors or do not have the amount ready. However, the collection rate can be increased by three simple measures:

#### 1. Introduce periodic fee collection (e.g. monthly).

Although it is more expensive to collect each month, the regularity of the collection and the smaller amount to be paid (compared to a bi-annual collection) should produce a better response.

#### 2. Officially appoint fee collectors.

Inform households about the responsible fee collector, who could be the waste collectors, an employee of the scheme or a voluntary community member, depending on the social network. However, according to experience, waste collectors are quite capable of collecting the fees efficiently, as they visit the households regularly and are known to the inhabitants.

### 3. Ensure accountability and transparency.

People want to know what happens with their money. Provide annual information on use of the money through information campaigns. As accountability is so important, introduce a receipt system. When receiving the monthly waste fee, collectors hand out numbered receipts, thereby providing residents with proof of their contribution. The fee collector has to report to the plant manager or to the accountant by handing over the fees and duplicates of the receipts.

### Activity 6: Try to promote source segregation

The most labour-intensive and tedious task of the composting process is waste separation. It can be facilitated if households of the community agree to segregate the waste, putting biodegradable (or “wet”) waste into a different container from the one used for other wastes (see Task 7). Recyclables are more easily sorted and of higher quality since they are less polluted. However, implementation of source segregation requires long-term preparation and vehicle modification (two compartments in the container).

If at-source segregation is being considered, this will require an intensive and long-lasting publicity and follow-up campaign in order to achieve a satisfactory degree of segregation, unless there are significant financial incentives. The European experience shows that in many cities source segregation could only be implemented by accompanying measures such as an incentive tax according to the “polluter-pays-principle”. That means that households pay fees only for residual waste collection; organic waste and recyclables are collected at no cost to the domestic generator. In this way more effective segregation results in lower fees. Such accompanying measures require an overall enforcement of existing solid waste management laws and regulations, and greatly depend on the political environment and the level of environmental awareness among the general public. Hence, do not expect too much success at the beginning, as the scheme is dependent on the awareness of the households and their voluntary participation. The following three activities will raise the awareness of the community:

- Prepare and distribute leaflets among the households describing the benefits of source segregation and guidelines helping residents to differentiate between inorganic and organic waste.
- Affix posters with basic information to your collection trucks.
- Organise an open-house event, inviting the community to the composting plant. Explain on site why source segregation greatly contributes to enhancing the operation of the composting plant. However, make sure that your composting plant is in excellent condition when you invite the community!

**Further reading**

UNCHS (Habitat) (1988): Refuse Collection Vehicles for Developing Countries, Nairobi (out of print but available on request from [www.sandec.ch](http://www.sandec.ch))

Rouse, J.R. & Ali, S.M. (2002): Vehicles for People or People for Vehicles, Loughborough University, ISBN: 1 84380 012 8, Loughborough (download from: <http://wedc.lboro.ac.uk/publications/catalogue.htm>)

UNDP & Ministry of Urban Development, Government of India (1993): Community based solid waste management – Project Preparation

Pfamatter & Schertenleib (1996): Non-Governmental Refuse Collection in Low-Income Urban Areas, EAWAG/SANDEC, Duebendorf, Switzerland (download from: [www.sandec.ch](http://www.sandec.ch))

GTZ (2005): Improvement of Sanitation and Solid Waste Management in Urban Poor Settlements, GTZ, Eschborn, Germany

Ogawa. H. (1988): "Selection of Appropriate Technologies for SWM in Asian Metropolises" a paper published in Regional Development Dialogue, Volume 10, No. 3, UNCRD, Nagoya, Japan.

## Task 6



Design and Construction of Composting Facility



- Identifying Stakeholder Interests : Task 1
- Assessing Target Community Interests and Land Availability : Task 2
- Data Collection : Task 3
- Preparing a Business Plan and Financial Projections : Task 4
- Development and Design of Collection System : Task 5
- Design and Construction of Composting Facility : Task 6**
- Operating and Maintaining a Composting Facility : Task 7
- Marketing of Compost : Task 8

## Task 6: Design and Construction of Composting Facility

*For a successful technology, reality must take precedence over public relations, for nature cannot be fooled. (Richard Feynman)*

This section describes a composting plant and its various components. Since local conditions strongly influence final composting plant design, the descriptions and illustrations provided should be used merely as guidelines and recommendations. Local construction experts should be consulted and the usage of materials adapted to the local context, but always related to the key functions of each component.

Task 6 gives guidance on design and construction of a composting facility processing three to five tons of (mixed) household waste per day. You will learn:

- how much space is required by a composting facility treating three tons of waste per day
- fundamental construction rules for the two composting processes presented
- useful construction material and equipment
- how to divide the available space into functional compartments to enhance the workflow.

Task 6 describes the design of composting plants applying the following two techniques:

- **Windrow Composting**
- **Box Composting**

The choice of a composting technology is dependent on several criteria, such as space availability near the housing area served. Box composting units require limited space and can be placed even along roadsides (see Photograph

Table 6.1: Matrix for selection of the most appropriate technology

| Constraining Criteria                           | Windrow Composting | Box Composting | Explanation   |
|---|--------------------|----------------|---|
| Space is limited                                |                    | X              | Box composting requires less space than windrows.                               |
| Long-term availability of land is not ensured   | X                  |                | Windrow composting requires less investment in stationary infrastructure.       |
| Financial constraints for initial investments   | X                  |                | Windrow composting is less expensive due to lower infrastructural requirements. |
| Labour is hard to find                          |                    | X              | Box composting requires less manpower than windrow composting.                  |
| Working with waste is perceived as “dirty work” |                    | X              | Box composting is less labour-intensive than windrow composting.                |

1.2), whereas windrow composting schemes need sufficient area for a proper setup. In any case they should be protected from unauthorised access and public view. Table 6.1 provides an overview of possible criteria to facilitate selection of the most appropriate technology.

### Activity 1: Plan and decide on the composting plant layout

A composting plant comprises an operation area and a “green” buffer zone. The buffer zone, formed by a belt of bushes and trees surrounding the operation area, improves the visual appearance of the composting plant (see photograph 6.6). The operation area is divided into different zones. It contains space for waste unloading and sorting, composting, maturing, sieving and bagging of the compost, including storage space for compost and recyclables. These zones must be arranged so as to ensure efficient workflow of the composting process.

Annex 4 contains two layouts of typical composting plants similar to the ones operated in Bangladesh. Annex 4A provides an example of a windrow composting plant, and Annex 4B a composting plant applying the box technique. Table 6.2 indicates the minimum space requirements for the different workflow units within the premises of a composting plant. Additional space should be allocated for a caretaker’s office and sanitary facilities for the workers. Take into account that the final setup of the site is strongly dependent on the local conditions.

Table 6.2: Required space for a composting plant processing three tons of waste per day

| Type                                 | Required Area Windrow Composting | Required Area Box Composting | Roof |
|--------------------------------------|----------------------------------|------------------------------|------|
| <b>Composting area</b>               |                                  |                              |      |
| Sorting area                         | 40 m <sup>2</sup>                | 40 m <sup>2</sup>            | yes  |
| Storage of rejects                   | 30 m <sup>2</sup>                | 30 m <sup>2</sup>            | yes  |
| Storage of recyclables               | 10 m <sup>2</sup>                | 10 m <sup>2</sup>            | yes  |
| Composting pad                       | 400 m <sup>2</sup>               | 360 m <sup>2</sup>           | yes  |
| Maturation area                      | 150 m <sup>2</sup>               | 150 m <sup>2</sup>           | yes  |
| Screening and bagging area           | 35 m <sup>2</sup>                | 35 m <sup>2</sup>            | yes  |
| Compost storage area                 | 25 m <sup>2</sup>                | 25 m <sup>2</sup>            | yes  |
| <b>Sub-total composting area</b>     | <b>690 m<sup>2</sup></b>         | <b>650 m<sup>2</sup></b>     |      |
| <b>Facilities</b>                    |                                  |                              |      |
| Office                               | 16 m <sup>2</sup>                | 16 m <sup>2</sup>            | yes  |
| Sanitary facilities                  | 10 m <sup>2</sup>                | 10 m <sup>2</sup>            | yes  |
| Tool shed                            | 10 m <sup>2</sup>                | 10 m <sup>2</sup>            | yes  |
| Water supply point                   | 4 m <sup>2</sup>                 | 4 m <sup>2</sup>             | no   |
| <b>Additional space requirements</b> |                                  |                              |      |
| Vehicles parking area                | 30 m <sup>2</sup>                | 30 m <sup>2</sup>            | no   |
| Green buffer zone (trees/bushes)     | 50 m <sup>2</sup>                | 50 m <sup>2</sup>            | no   |
| <b>Total area</b>                    | <b>810 m<sup>2</sup></b>         | <b>770 m<sup>2</sup></b>     |      |

These composting schemes can be scaled up or down depending on the local conditions. Since both composting systems are modular, the composting area can be extended to five tons of waste per day. To protect the workers from difficult and unhygienic working conditions, this capacity should not be increased beyond that amount as the system is still based on manual work. If more waste has to be treated, a higher degree of mechanisation (causing higher investment and operational costs) will have to be considered. However, higher capacities are unnecessary, as the decentralised composting sites seldom cover more than 3000 households.

## Activity 2: Plan the required key features

The following key features have to be considered during planning and construction regardless of the type of composting scheme chosen:

**On-site water supply** is a basic infrastructural requirement on a composting site. Since it is used for hygienic purposes and for watering the compost heaps, a reliable water supply should be ensured, such as a standpipe on the site. An additional water storage tank is, however, advisable if the

water supply is not continuous. A further useful feature is a rainwater harvesting system. The roof of the composting shed and other facilities can be specially designed to collect rainwater from the rooftops. During the rainy season, water can be collected in a tank to bridge water shortages during the dry season. The storage volume is dependent on the length of the dry season and on the daily water demand. Rainwater can be used for the composting process, for cleaning and washing of the composting plant and for watering of the green belt. Figure 6.1 shows a rainwater collection and storage system at a composting site. A guide for capacity calculation and design is available on Sandec's webpage: Rainwater Harvesting at the Co-Composting Site in Kumasi, Ghana.

<http://www.sandec.ch/Publications/PublicationsHome.htm#SWM>

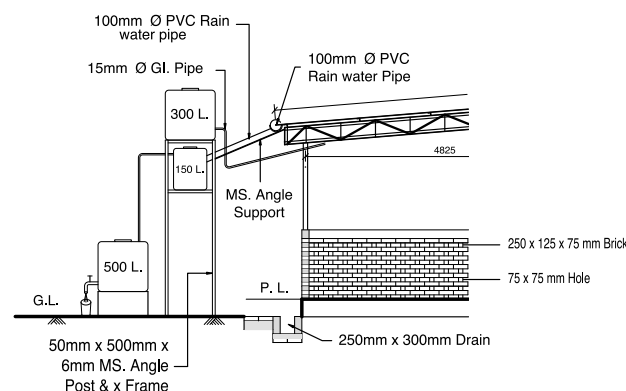

Figure 6.1: Diagram of a water storage system combining water storage and rainwater harvesting



Photograph 6.1: Rainwater harvesting system at the co-composting pilot plant in Kumasi, Ghana. The small "first flush tank", behind the main tank, collects the first incoming rainwater, diverting dust and dirt from the roof. (Sandec)

Both **windrow and box composting operations should be conducted under a roof** to protect the compost piles from excessive rain and sun. Simple light structures with vertical steel angles, mild steel pipes or wood or bamboo poles can be used to support the roof. Photograph 6.1 and Figure 6.5 illustrate two types of roof constructions. To allow easier workflow during composting, the minimum distance between the pillars should be three meters. Corrugated iron sheets, bamboo thatch or any other locally available roofing

material can be used. Depending on the soil bearing capacity, special attention should be given to construction of the foundation to avoid settlement and cracks in the structures. Jute or specially designed compost fleece is suitable in semi-arid and arid regions to protect the compost from excessive evaporation. Since compost requires oxygen for decomposition, the cover must be permeable to air. Photograph 6.2 illustrates the use of a compost fleece on small windrows.



*Photograph 6.2: A composting fleece protects compost piles from excessive sun and rain if no roof is available. The fleece also prevents the compost from being rummaged by animals. (Sandec, Community Composting, Switzerland)*

The **sorting area** consists of a sealed concrete surface where waste is sorted into organics, inorganic recyclables and rejects. The sealed surface facilitates cleaning after sorting is completed. Since the waste delivered may be high in moisture, the area should be slightly sloped (1%) to avoid leachate ponding. A drainage system collects leachate and cleaning water to be reused for watering composting windrows (see Annex 4C).

In Bangladesh, sorting is conducted on the floor with rakes and shovels (see Photograph 7.1 in Task 7). In other contexts, construction of a sorting table or platform allowing people to stand upright could be appropriate. Three sorting options are illustrated in Figures 6.2 to 6.4. More sophisticated sorting systems with conveyor belts are not recommended for such small-scale composting facilities, as they require significantly higher investment and operational costs.



*Figure 6.2: Sorting on the ground. Organic waste is filled into buckets and carried to the windrow or box*



*Figure 6.3: Sorting on a platform. Waste is delivered onto the platform. Workers stand upright and sort out organic waste and fill it into wheelbarrows below. Advantage: no further need for shoveling and no direct contact with the waste*

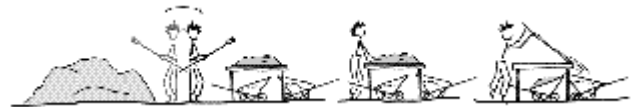

*Figure 6.4: Sorting on a sorting table with hinged table top. Waste is shoveled onto a table and rejects are sorted out. Remaining organic waste is filled into a wheelbarrow by lifting the table top. This system is suitable for waste with a very high biodegradable fraction such as waste from fruit and vegetable markets*

The **storage areas for rejects and recyclables** should be roofed and possibly enclosed to prevent roaming animals from entering the site. The area has to be accessible to trucks, as the rejects have to be collected frequently. A covered container for rejects, easily picked up and replaced by a truck, is a good alternative to a storage room. The necessary storage volume is determined by the collection frequency. The required amount of storage space can be calculated by the following equation:

$$vol_{rejects} = \frac{(waste_{tot} - waste_{recyclable} - waste_{organic})}{density_{rejects}}$$

|                      |  |
|----------------------|--|
| $waste_{tot}$        | total waste amount (kg)  |
| $waste_{recyclable}$ | recyclables (kg)   |
| $waste_{organic}$    | organic waste (kg)   |
| $density_{rejects}$  | density of rejects (kg/m <sup>3</sup> ) varies between 300 and 600 kg/m <sup>3</sup> |

The area required for the storage zone for recyclables is dependent on the inherent properties of the materials. Paper and cardboard for instance only have to be bundled and piled, while plastic and glass are collected in old bags.

Each plant should have a lockable **office** equipped with basic furniture to allow the supervisor to keep the monitoring and accounting records. It also provides a sheltered **area for breaks** and for storing personal belongings. **Sanitary installations**, such as toilets and washing facilities, are essential. After handling waste and compost, the workers should wash and change their clothes before leaving the workplace. Small equipment, such as sieves, shovels and rakes, should be stored in the **tool shed**. Such facilities require approximately 40 m<sup>2</sup>, and all should be roofed and fitted with lockable doors for security reasons.

### Specific features of the windrow composting area

The composting area is preferably a concrete slab slightly sloped (1%) towards one side to allow excessive water from the compost heaps to flow into a drain. Along the lower end of the slab, a drainage channel for leachate collection leads to a collection point. An area of 360m<sup>2</sup> is sufficient to hold seven parallel windrows (see Annex 4A and 4B).

Triangular aerators significantly enhance windrow composting. If possible they should be constructed of a material that is resistant to natural degradation. Aerators made of bamboo and plastic are described here. The advantage of the bamboo aerator is its low price and availability. However, bamboo is not entirely resistant to degradation and has to be replaced frequently. To construct bamboo aerators like shown in photograph 6.3, bamboo strips are nailed lengthwise onto triangular wooden frames (maintaining equal gaps). The plastic model is made of perforated plastic panels. This model is more expensive but also more resistant to natural degradation and has a longer service life. The sides of a triangular aerator measure 0.6 m and the entire length of an aerator is 2.7 m. As can be seen in the schematic layout of Annex 4A about 36 aerators are necessary for a windrow composting plant that processes about three tons of sorted organic waste waste.

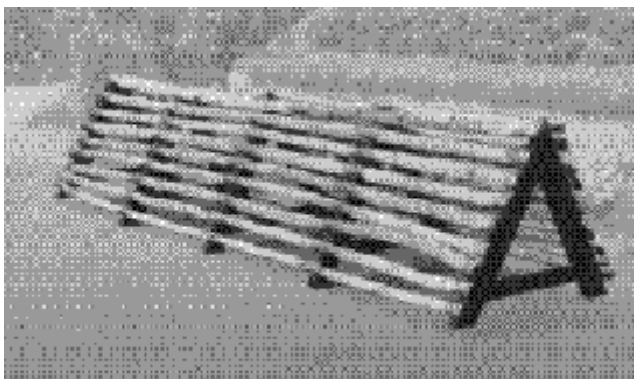

Photograph 6.3: Bamboo aerator; side length of triangular frame 0.6 m, length 2.7 m (Waste Concern, Bangladesh)



Photograph 6.4: Piled waste around short plastic aerators (Waste Concern, Bangladesh)

### Specific features of the box composting area

The layout of a box composting system is illustrated in photograph 6.5, Figure 6.6 and Annex 4B. Box composting requires less space but more construction efforts and higher investments than windrow composting. A plant processing three tons of organic waste requires about 24 boxes (1.45 m wide, 6 m long and 1.2 m high). The front side of the box is closed by means of removable wood panels, which can be removed for emptying the box (see Figure 6.6). Since the distance between the boxes is 0.75 m, the total space requirements are lower than for the windrow technology. The slab on which the boxes are built should be sealed and slope towards one side. Leachate collection channels leading to the edge of the composting floor are located between the boxes and discharge into a central collection point. To improve the oxygen supply to the pile, the box wall contains gaps between the bricks. The perforated base of the box should be resistant to corrosion and thus is equipped with small PVC pipes or a coated metal grid. This base ensures better aeration and drainage of excessive water from the pile (see details in Annex 4C). Finally, perforated PVC pipes (see details in Annex 4C) are placed vertically inside the box to provide additional oxygen exchange within the compost material.

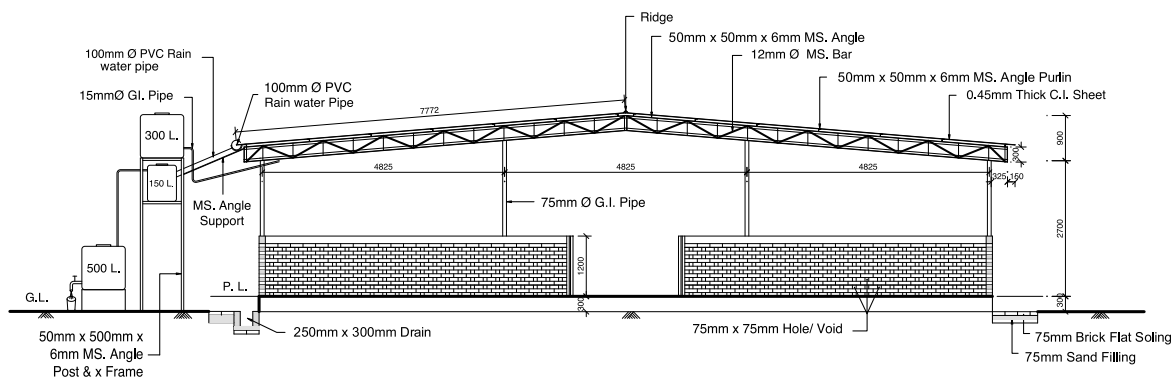
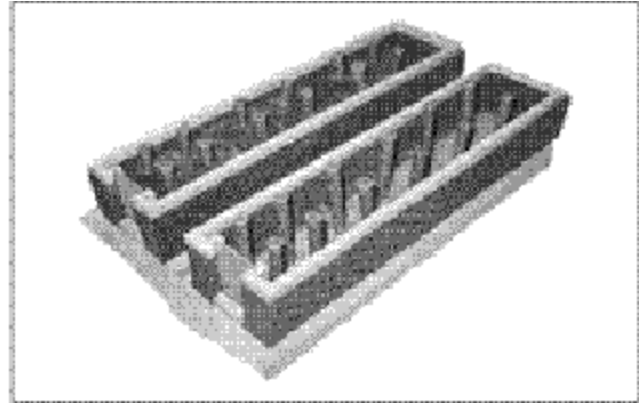
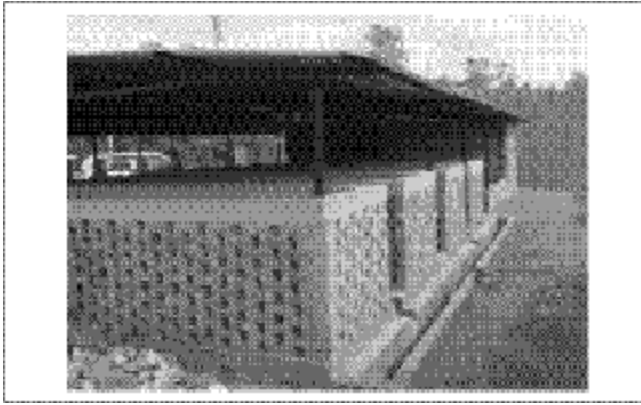

Figure 6.5: Cross section of a typical three-ton composting plant (box composting) with details of roof, floor, compost box, and drainage system (Waste Concern, Bangladesh)



Photograph 6.5 and Figure 6.6: Box composting plant and close-up model of a compost box with plastic door at the front end facilitating emptying (Waste Concern, Bangladesh)

### Useful additional composting plant features

Apart from compost production, the composting plant can promote among the citizens the idea of resource conservation and recycling. A series of additional composting plant features are presented here to illustrate how a composting plant can raise environmental awareness:

**Kiosk:** A small, square-shaped structure with a light roof can be set up within the premises of a composting plant. The kiosk can be used as a sales and display point for compost products or potted plants raised on compost. A kiosk like that shown in Figure 6.7 can help promoting organic farming and agricultural use of compost to visitors of the site.



Figure 6.7: Example of a kiosk replicated in 14 towns in Bangladesh (Waste Concern, Bangladesh)

**Organic farming demonstration site:** If sufficient land and staff are available, a small plot inside the composting plant can be used as demonstration unit for organic farming or as a nursery for pot plants. The core idea is to encourage the owner of the composting plant to maintain, as far as possible, the facility *clean and green*. A clean and pleasant environment near a composting plant can change negative perceptions of waste treatment and the use of compost can be directly demonstrated to visitors. Furthermore, a nursery creates an additional source of income (Figure 6.8).



Photograph 6.6: Nursery and organic farming unit in a composting plant in Dhaka, Bangladesh (Waste Concern, Bangladesh)



Figure 6.8: Composting plant with an integrated plot for organic farming for promotion. (Waste Concern, Bangladesh)

**Wastewater reuse system:** A significant amount of wastewater is generated during composting and the cleaning of the facility. Instead of discharging the wastewater into drains, it can be reused for new compost piles to maintain the moisture balance and enhance the decomposition process. Wastewater from the drainage system can be collected in a small covered storage tank below ground level. By mixing this wastewater with fresh

Table 6.3: Staff required for a three tons/day composting plant

|                                | Windrow Technique | Box Technique | Requirements  |
|--------------------------------|-------------------|---------------|---|
| Manager/ Engineer              | 1                 | 1             | Graduate with management skills and willing to work with waste. Responsible for monitoring mass flows, keeping records on plant performance and accounting. Strategic planning and marketing if not conducted by an external agent (e.g. NGO or company). |
| Collection workers (part-time) | 4                 | 4             | Basic mechanical skills, responsible for maintenance and minor repairs.   |
| Composting workers (full-time) | 6                 | 4             | At least one worker should be literate, responsible for temperature monitoring and recording.   |
| Lab staff (optional)           | 1                 | 1             | Graduate with chemical background.  |
| Marketing staff (optional)     | 1                 | 1             | Graduate in marketing and/or agricultural economics.  |

water from the pipes or rainwater tank, scarce water resources can be extended and conservation promoted.

**Energy efficient lighting system:** If the compost plant is connected to the electricity grid, an energy-efficient lighting system should be fitted to set a good example of energy conservation and to reduce operational costs in the long run.

### Activity 3: Plan staffing requirements

Generally, the staff of the composting plant needs to be willing to work with waste. Such a commitment ensures long-term capacity building and increases know-how within the plant. Selection of staff strongly depends on local habits and values (culture, religion, gender, perceptions) and has to be discussed in detail (e.g. if women can be involved in waste handling). Experience reveals that composting plants often provide interesting job opportunities for underprivileged and poor people. Formalised waste collection, sorting and composting ensures long-term employment and the opportunity to get trained on the job and specialised in composting. However, some of the workers should be literate, as the composting process requires reliable monitoring and recording activities (e.g. temperature, weight and moisture measurements). Furthermore, the composting business also offers jobs for dedicated engineers, which have the overall responsibility of management and operation. Table 6.3 describes jobs, necessary skills and the average number of required staff for a composting plant processing three tons of waste per day.

### Activity 4: Plan additional equipment and expendables

Additional equipment and expendables, as shown in Table 6.4 guarantee workers' safety and promote efficient process performance. Most of the equipment is also illustrated in the photographs in Task 7 (Operation and Maintenance). Apart from the sieving equipment, most of the expendables must be replaced frequently (e.g. monthly or annually) and considered in project budgeting. The waste collection equipment is not considered here.

Table 6.4: Additional equipment and expendables

| Items   | Windrow and Box Technique |
|---|---------------------------|
| <b>Sorting</b>  |                           |
| Sorting table (if favoured)   | 2                         |
| Buckets   | 6                         |
| Shovels   | 6                         |
| Rakes (long or short handle)  | 6                         |
| <b>Composting</b>   |                           |
| Watering pots   | 2                         |
| Thermometer   | 2                         |
| <b>Sieving (two alternatives)</b>   |                           |
| Flat frame sieve (Photograph 7.14, mesh size 8 and 16 mm)                 | 2                         |
| Sieving drum (Photograph 7.15, mesh size 8 and 16 mm)                     | 1                         |
| <b>Bagging</b>  |                           |
| Bags (woven plastic bags, their size is dependent on market availability) | Depending on requirements |
| Equipment for sealing bags  | Depending on requirements |
| <b>Miscellaneous</b>  |                           |
| Brooms  | 6                         |
| Baskets   | 6                         |
| Uniforms, gloves, boots and face masks                                    | Two sets for each worker  |

### Further Reading

Diaz, L. et al. (1993): Composting and recycling municipal solid waste, ISBN 0-87371-563-2. This comprehensive book covers all aspects of solid waste collection, characterisation and recycling. Chapters 6, 7 and 8 focus on composting and markets for compost.

Haug, R.T. (1980): Compost Engineering, Principles and Practices, ISBN 0-250-40347-1. This book is more suitable for technicians and engineers which seek more information about the process engineering of composting.

Chiumetti A., Chiumetti R, Diaz L., Savage G., Eggerth L. (2005): Modern Composting Technologies, BioCycle, Emmaus, USA, (ISBN 0-932424-29-5).

## Task 7



Operating and Maintaining a Compostion Facility



- Identifying Stakeholder Interests : Task 1
- Assessing Target Community Interests and Land Availability : Task 2
- Data Collection : Task 3
- Preparing a Business Plan and Financial Projections : Task 4
- Development and Design of Collection System : Task 5
- Design and Construction of Composting Facility : Task 6
- Operating and Maintaining a Composting Facility : Task 7**
- Marketing of Compost : Task 8

## Task 7: Operating and Maintaining a Composting Facility

*By the work one knows the workmen. (Jean de la Fontaine, 1621 - 1695)*

Composting comprises various steps starting from waste sorting until the final bagging of the compost product. Task 7 gives guidance for the operation and maintenance of a composting plant including aspects of quality control and trouble shooting. The composting process can be divided into nine steps which are shown in Figure 7.1 below. Waste from households arriving at the composting plant is sorted into several fractions. The organic fraction enters the composting process. It is mixed with additives if necessary and piled into the composting system. The composting process has to be monitored by different parameters (temperature, moisture). Finally, the mature compost is screened and prepared for selling. Residues from sorting and screening are recycled or disposed of.

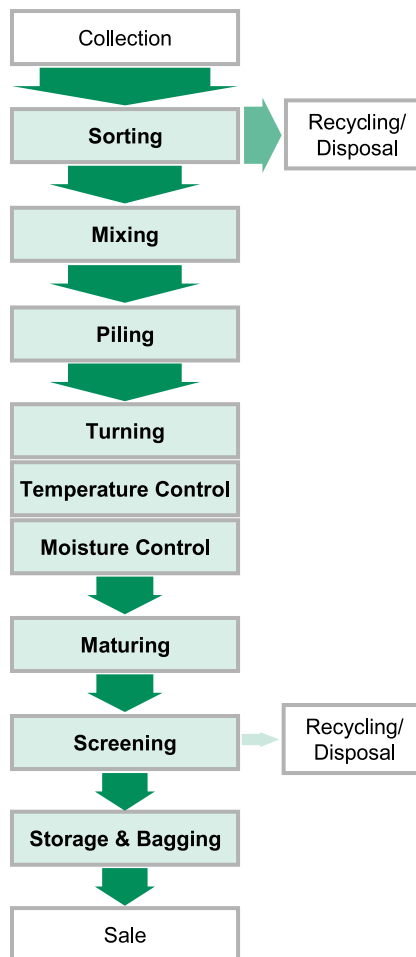

Figure 7.1: Flow chart showing composting process steps and material flows

After finalising the activities of Task 7 you will have been informed about:

- the different steps of a composting process
- the required quality criteria for input material and additives
- how to measure important process parameters such as temperature and moisture
- how to maintain the compost plant
- which are the typical problems of the composting process and how to solve them
- the most important quality criteria and how to control them.

### Activity 1: Operation and monitoring

Operational safety and health protection for workers should be the priority concern. Workers should be obliged to wear protective gear like uniforms, gloves and boots at any stage when they are handling waste and compost.

#### Step 1: Sorting

Compost quality is mainly determined by the quality of the input material. Hence, the sorting of the waste plays a vital role. Substances which are not biodegradable need to be separated from the biodegradable fraction. Sorting is especially crucial with regard to hazardous materials. They must be removed before the composting piles are formed. Otherwise they will contaminate the entire pile and severely compromise the final compost quality. Figure 7.2 shows the classification of typical domestic waste and gives guidance regarding which materials are suitable for composting.

If households are willing to segregate their waste at source it saves a tremendous amount of time and costs for the composting scheme. Moreover, it increases the quality of both biodegradable waste and recyclables. Hence, the long term goal should be the introduction of source segregation of waste in households.

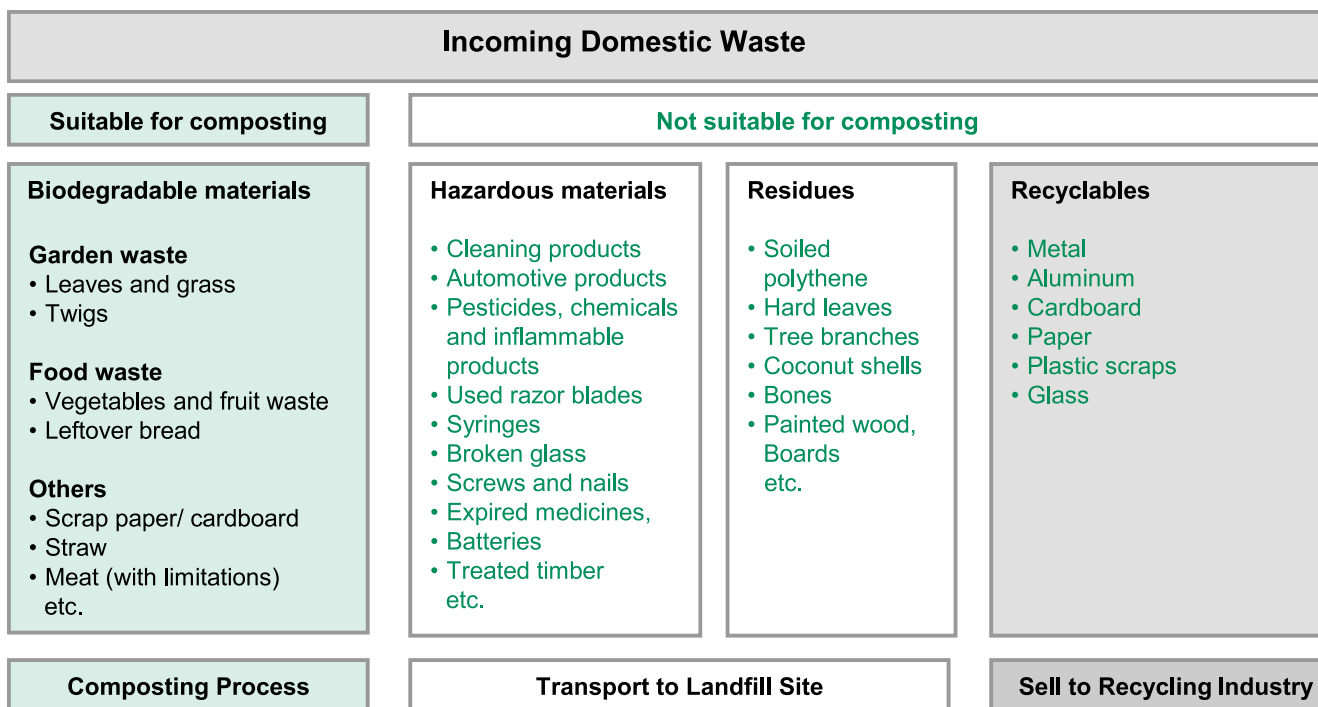

Figure 7.2: The quality of compost strongly depends on the input material. If source segregation cannot be implemented waste separation prior to composting is necessary

### Sorting of incoming waste

- As soon as the mixed household waste arrives at the composting site, it is separated manually into biodegradable material, recyclables, and rejects.
- Manual sorting can be done in different ways: on the ground with a small rake (as practised in Dhaka, Photograph 7.1) or on a sorting platform or table (see Figures 6.2, 6.3 and 6.4). Workers must wear protective gloves, boots and masks as they are in close contact with the waste.
- Rejects and recyclables are sorted into different buckets and/or baskets. Recyclables are stored for sale in a shed. Rejects are either disposed of in nearby municipal waste bins or temporarily stored on-site before being transported to the landfill.
- The biodegradable waste fraction is further processed inside the plant.
- After having finished the sorting process, the sorting platform is cleaned. No waste should remain overnight on the sorting platform as it can attract vermin and cause smell.

It depends on your local market which materials can be sold as recyclables. In most cases at least a market for paper and cardboard already exists. In other cities industries processing glass, plastic or aluminium can be found. Check the local market for prices and retailer networks. Generally, industries only accept bulk delivery. If space is limited, it might be more suitable to find a reliable middleman instead of storing big amounts of recyclables on the composting site.



Photograph 7.1: Sorting of incoming mixed household waste. Consider the local habits: some prefer sorting on the ground, other prefer a table or platform. (Waste Concern, Bangladesh)

### Step 2: Mixing

The ratio of carbon (C) to nitrogen (N) - also called C/N ratio - is very important for the biological degradation of organic waste. Both C and N are feedstock for micro-organisms responsible for the degradation of the organic matter. While carbon is important for the cell proliferation, nitrogen is the nutrient source. Annex 7 provides additional information about the biological processes during composting. The text explains the effects of a too high or a too low C/N ratio in the composting process and how problems can be avoided.

The first assessment of the waste composition described in Task 3 (Data Collection) already revealed the general characteristics of the local solid waste. Generally one can classify “green” materials as being high in nitrogen and

“brown” materials as high in carbon. The input material should have a carbon/ nitrogen ratio of 25:1 to 40:1 to allow most rapid and efficient degradation of the organic material. The wide range of the C/N ratio already indicates that a certain variation of waste components is possible. It is recommended to keep incoming “brown” waste (i.e. from parks) separate from “green” household waste and to add it later depending on the composition of the household waste. For a start, these “green” materials and “brown” materials are mixed in equal volumes. This ratio may need to be adjusted if the composting process is not satisfying. For instance, if the waste is very wet with little structure (e.g. kitchen or restaurant waste) the fraction of “brown” materials has to be increased (not only to correct the C:N ratio, but also to reduce the moisture content and to encourage the movement of air) Table 3.1 (in Task 3) indicates that household waste is already close to the ideal C:N ratio and normally needs just little additional “brown” material high in carbon.

In practice, the ideal combination of wastes for composting must be determined by trials. It takes some time to learn the specifics of your local waste. Over time, the plant manager will get a keen sense of how to mix the different incoming waste types and when to add wood chips or animal manure. Laboratory tests of your waste can assist in finding the ideal ratio but are not crucial.



*Photograph 7.2: Wood chips or saw dust is an ideal carbon source if the waste is too wet and too high in nitrogen (Waste Concern, Bangladesh)*

#### **The right waste mixture in a nutshell:**

- An efficient composting process needs a C:N-ratio within the range of 25:1 to 40:1.
- Wood chips or sawdust (high C) or manure (high N) may be mixed with the organic waste to optimize the C:N ratio. Wood chips can also increase the pile porosity, thereby improving aeration.
- Organic screening residues from previous piles can be added to fresh piles as a carbon source. As the screening residues already contain micro-organisms, they also accelerate the start-up of the composting process.



*Photograph 7.3: Thoroughly mix the waste before piling it onto the aerator (Waste Concern, Bangladesh)*

#### **Step 3: Piling the Waste or Filling the Box**

In Task 6 you already decided which composting system is most appropriate for your requirements:

- **The Windrow Composting Method or**
- **The Box Composting Method.**

This previous decision determines the further handling of the waste. Steps 1 and 2 described above are the same for both systems, but the further handling of waste varies for each system. Thus step 3 describes separately the operation of the two systems.

#### *Alternative 1: Preparing the windrows on aerators*

The sorted organic waste is loosely heaped onto the bamboo or plastic aerators (see Photographs 7.4 and 7.5) and formed into long piles (windrows) as shown in Photograph 7.6. The composting piles have a width of 1.6 m and a maximum height of 1.6 m. The length depends on the space available and the amount of incoming waste, but 2 to 3 m is generally recommended. The waste of 2 to 3 days can thus be accumulated on one aerator. It is not recommended to take more than three days to build a windrow because this would lead to inhomogeneous decomposition. The windrow shown in Photograph 7.6 has a volume of approximately 5 m<sup>3</sup> and holds about 4 tons of organic waste from two days of collection. This windrow design allows sufficient oxygen supply and optimal heat generation, maximising the decomposition rate of the waste. The aerators and the restricted height and width ensure sufficient oxygen supply and prevent the pile from overheating. (Heat is developed in a compost pile that has the right conditions of C:N ratio, moisture content and air supply because huge numbers of bacteria are actively feeding on the waste. More information about the composting process can be found in Annex 8.)

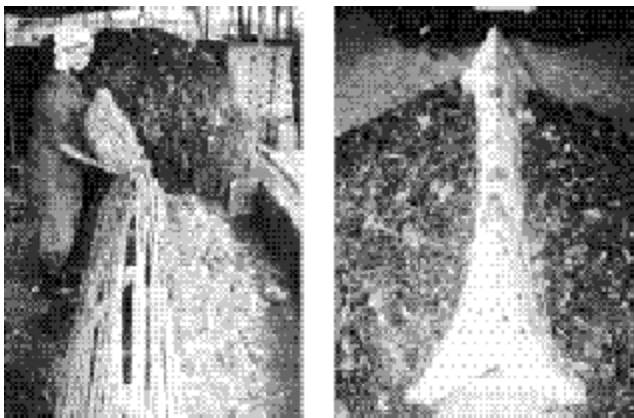

Photograph 7.4 and 7.5: The waste is piled around and onto the aerator (height 1.5 m) (Waste Concern, Bangladesh)



Photograph 7.7: The windrow is turned weekly to improve the aeration of the pile. The steam indicates the high temperature and water loss during the composting process (Waste Concern, Bangladesh)

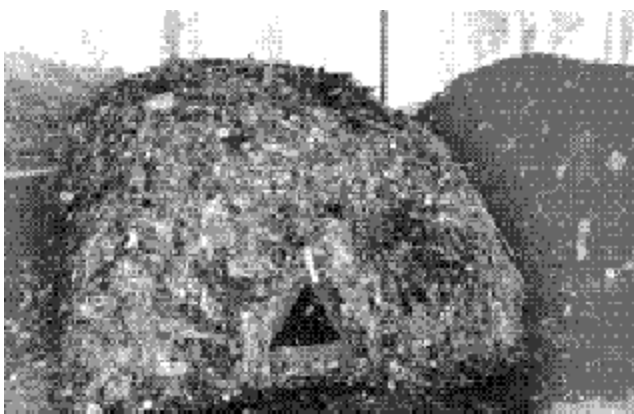

Photograph 7.6: Fresh organic waste on the aerator with the bamboo rack at the base (Waste Concern, Bangladesh)



Photograph 7.8: A windrow after 40 days of composting and being turned several times. The volume reduction is obvious (Waste Concern, Bangladesh)

### Windrow Composting Method

In contrast to the typical windrow method the waste is piled onto a triangular wooden or plastic rack allowing a passive aeration of the compost pile. The additional aeration from the bottom of the pile allows micro-organisms to decompose the organic waste efficiently through a better oxygen supply and improved temperature control. Within 24 hours the micro-organisms within the waste start to multiply and generate heat. Pile temperature increases to 55 - 65°C which is optimum for aerobic composting. To enable the micro-organisms to obtain sufficient oxygen, the pile is additionally aerated by turning the waste from time to time (approximately once a week). High temperature leads to water losses through evaporation, so additional water must usually be added with each turning. After 40 days of composting the temperature has decreased, indicating a slowing down of the process. As less oxygen is demanded, the raw compost can be removed from the aerator and piled again for the maturation phase without a central aerator. For another 15 days mesophilic micro-organisms further stabilise the compost leading to the final mature compost product.

### Box Composting Method

The box is constructed with perforated walls, a perforated bottom grid and vent-pipes allowing air circulation through the waste. (see Photograph 6.5 and Annex 4B) In contrast to the aerator method, the sorted organic waste is daily spread into the boxes in layers of 20 cm. The construction of the box in combination with the layer technique ensures sufficient aeration and additional turning is not necessary. Air is supplied to the organic material through holes in the walls and through the perforated vertical pipes embedded in the pile. The perforated bottom of the box additionally acts as drainage for excessive water. As in the windrow system, the temperature within the mass increases within a few days up to 60°C, ensuring that the final compost product is free of viable pathogens or weed seeds. Typically, a box is filled within 5 - 7 days and the waste in the box decomposes aerobically for 40 days before it is removed from the box. As with the windrow technique, the compost needs another 15 days of maturing.

### *Alternative 2: Filling the composting boxes*

The sorted organic waste is loosely spread in layers of 20 cm into the box, around the vertical aeration pipes. If one box is not sufficient, the remaining waste has to be spread in a second box. Assuming an input load of 3 tons or 5 m<sup>3</sup> of organic waste per day and a box system as described in Task 6, two boxes are filled within 5 to 6 days. The boxes receive one layer of waste per day. Every time a layer is added it is loosely mixed with the previous layer using a fork or shovel. When the box is full the waste is left for 40 days to go through a thermophilic composting process similar to the windrow system. Frequently measure the temperature inside the box following the procedure described below in Step 5 (Temperature control). For measuring the moisture weekly dig several holes into the compost and check the moisture content according to the description of Step 6 (Moisture control) later in this chapter. If the material is too dry spray water over the compost and level the material again. After 40 days one side of the box is opened and the fresh compost is removed from the box and stored as a pile for further maturation. Apart from Step 4 (Turning of Windrows) all steps below are the same for both aerator composting method and box composting method.

### **Step 4: Turning of Windrows**

One of the important factors during the composting process is to ensure sufficient supply of air. Within a few days, aerobic micro-organisms exponentially proliferate, consuming an enormous amount of oxygen. A lack of oxygen likely favours the growth of anaerobic organisms which cause unpleasant odours. Furthermore, anaerobic conditions slow down the degradation process resulting in a longer composting period. Thus, attention must be given to ensuring an adequate air supply.

The bamboo or plastic aerators already increase the oxygen supply by passive aeration through the bottom. Turning the material frequently as shown in Photograph 7.7 provides additional oxygen to the system as the waste comes into contact with fresh air. The system described here is based on manual turning like shown in Photograph 7.7. The composted material is removed from the aerators with rakes, taking care not to damage the aerators. The presence of steam is a good indicator of the effectiveness of the composting process. Initially the material should be turned 2 to 3 times per week as the composting process is very active with a high oxygen demand and reaching temperatures up to 70°C. When the temperature starts to drop, the pile still needs to be turned every 10 days. In total 5 to 8 turnings within 40 days are necessary.

Turning has several advantages over a system that blows air into a static pile of biodegradable material (Static forced ventilation system):

- It helps to keep the pile temperature within the optimum range of 60–65°C: If the temperature becomes too high the material remains spread out on the floor for about fifteen minutes during the turning process before it is re-piled (see Step 5 below, temperature control).

- Turning ensures that all biodegradable material gets in contact with air, thus avoiding “anaerobic zones” causing unpleasant odour.
- Water losses can better be compensated for during turning, ensuring a more even distribution of the added water.
- Turning allows the less composted outer layer of the windrow more chance of getting inside the pile, ensuring a better hygienisation (killing of fly eggs and pathogenic microorganisms) of the final compost. The waste should be thoroughly mixed before it is re-piled.
- The mechanical stress on the material favours a high degree of homogenisation of the entire waste material leading to an accelerated process and an end product with a finer structure.

### **Step 5: Temperature Control**

Provided that the C:N ratio, the aeration and the moisture content are all within the optimal range, the micro-organisms multiply exponentially. This microbiological activity results in a temperature increase to 65–70°C within 1 to 2 days. (see Annex 7) Temperatures above 70°C need to be avoided as they are too high for even thermophilic bacteria and so inhibit the microbiological activity. Temperatures above 80°C are lethal to most soil micro-organisms and the process comes to a halt. Although composting will occur at temperatures below 65°C, a temperature of around 65°C favours rapid composting and ensures the destruction of weed seeds, insect larvae, and potential plant or human pathogens. Therefore, it is preferable for the temperature of the composting pile to stay at around 65°C for at least three days. After the first week, the temperature gradually decreases and the decomposition process slows down. The process moves into the mesophilic phase (45- 50°C) and other micro-organisms take over the transformation until the waste material is transformed into fresh compost.

### How to measure the temperature:

- Use an alcohol thermometer and attach a string to the top of the thermometer. (Do not use mercury thermometers as the mercury can pollute the entire compost pile if they break during measurement. Mercury belongs to the group of heavy metals and is classified as a hazardous substance.) If available, a digital thermometer with a stick probe is preferable. (see Photographs 7.9 - 7.11)
- If you use an alcohol thermometer for measurement, firstly push a hole into the compost down to the required depth within the pile using a broom handle or an appropriate stick.
- Then carefully lower the thermometer into the hole with the string
- Leave the thermometer in the compost for about 1 minute then pull the thermometer out by the string and immediately record the temperature.
- Record the temperature trends twice a day at three points within the pile – the top, middle and bottom of the pile or the box. A template for recording temperature is given in Annex 9.
- Record the ambient air temperature as well.



Photograph 7.9: Temperature measurement with an alcohol thermometer (Waste Concern, Bangladesh)

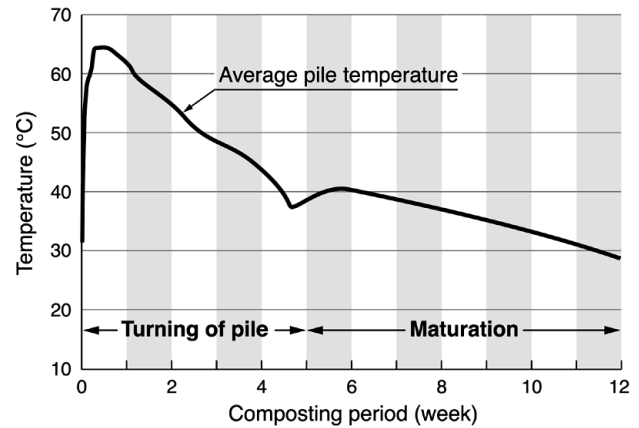
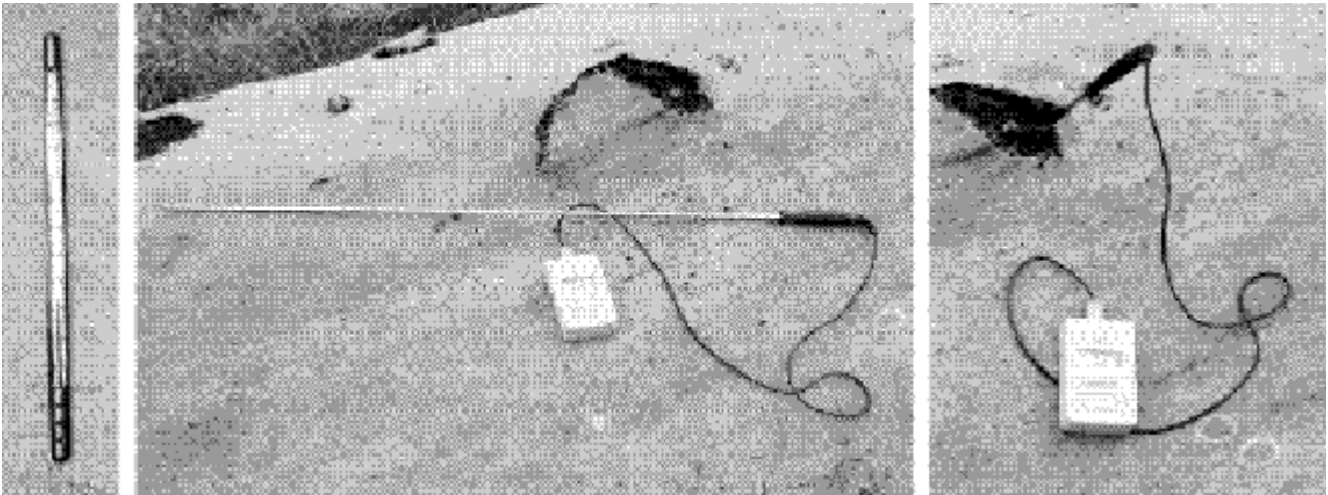

Figure 7.3: Temperature curve showing the two composting phases: thermophilic phase with frequent turning, maturation (mesophilic) phase with occasional turning



Photograph 7.10 - 7.11: Two types of thermometers: Alcohol thermometer and electronic thermometer with stick probe (Sandec, Switzerland)

### Step 6: Moisture Control

Microbes take up nutrients only as dissolved ions in a film of water. Thus, the moisture content of the waste plays an important role. To ensure rapid decomposition, maintain the moisture content in the composting piles at a level of 40 to 60%. Ideally, water is only added during turning as the material is spread out on the floor. Photograph 7.12 shows the watering of a freshly made windrow in which the water content in the outer layer was too low.



Photograph 7.12: Watering of a completed compost windrow (Waste Concern, Bangladesh)

Figure 7.4 describes a quick test for moisture measurement. Take a handful of compost and squeeze it hard. If only a few drops of water appear the moisture content is in the optimal range. If no drops emerge the moisture content is below 40%, indicating that the nutrient provision is hampered. Consequently, the composting process slows down. Often, the temperature of the waste pile decreases though the process is not finished, because the water content is too low. Adding water raises the temperature of the composting pile and the decomposition process continues. (see also Step 7 below: maturity test) If the moisture content is too high, the pile tends to become anaerobic and produces unpleasant odors.

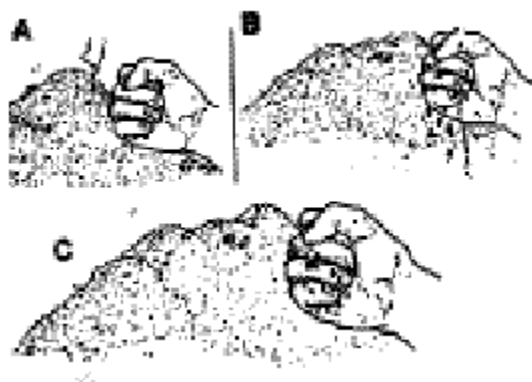

Figure 7.4: Testing of Moisture Content: Protect your hand with a glove. Take a handful of compost and squeeze it in your fist. **A:** If no water is squeezed out, the compost is too dry; **B:** If many drops can be squeezed out, the compost is too wet; **C:** If few drops can be squeezed out, the moisture content is ideal (CPIS, 1993)

- Wear protective gloves when testing the moisture (squeeze test) for hygienic reasons and in case there are sharp materials in the compost.
- Add water during turning with a sprinkler until optimal moisture content is reached.
- The box system needs less water as the material is not turned.
- In some cases compost produce excessive water (leachate) in the beginning of the process. This leachate can be collected and reused for watering the next pile.

### Step 7: Maturing / Curing

After about 40 days, the material in the piles has a colour like soil and the pile temperature has fallen below 50°C. This indicates that the process has entered the curing or maturing phase. Other micro-organisms and small insects like caterpillars and bugs re-colonise the still immature compost. Slowly, they further break down the more complex organic materials like cellulose while producing substances somewhat like topsoil. Additional three weeks are necessary to ensure that the compost is mature and suitable for direct application to plants (photograph 7.13). During this phase the compost needs less oxygen and less water. The temperature constantly goes down to the ambient temperature.

- Remove the fresh compost from the aerator or empty the box.
- Pile the fresh compost in the maturing area. The piles can be moved closer together and piled higher (to a maximum height of 1.5 m) to save space.
- Turning is no longer necessary.
- Only little watering is necessary, if the piles are very dry.
- During the rainy season, keep the compost under a roof to prevent it from getting soaked. Rain might leach valuable nutrients from the compost.
- Continue daily temperature monitoring until the compost is at the ambient temperature. If the temperature of the compost rises when water is added to it, the compost is not mature and needs additional days for final curing.
- The presence of white or grey colour indicates the presence of fungi, which are important micro-organisms for the composting process. Their appearance also indicates that the pile is still in the mesophilic phase.
- Mature compost appears dark brown, has an earthy smell and a crumbly texture.





*Photograph 7.13: Fresh compost rests in a pile for an additional three weeks for maturing. (Waste Concern, Bangladesh)*

### **Step 8: Screening**

The mature compost has a rather coarse texture. The particle size of the compost strongly depends on the size and the composition of the input material and the turning frequency. In many cases finer compost is required and so the compost must be screened. The screening is done either by using a flat frame sieve (see Photograph 7.14) or a rotating drum sieve (see Photograph 7.15 and 7.16). Each size and type of sieve with its particular mesh size is suited for a particular throughput and application. In any case they need to be adjusted to the local conditions and compost structure.

- The frame sieve (a rectangular wooden frame with a wire mesh stretched across it) is propped up in a sloping position. The raw compost is thrown onto the sieve and rubbed through the mesh.
- A manual rotating drum sieve is more expensive but can have a higher throughput. It also protects the workers from close contact with the compost.
- There are four different grades of compost, which may be referred to as coarse, medium, fine and superfine. Screens with four centimetre square openings are used for the medium grade of compost and a one centimetre mesh is used for fine grade of compost.
- Compost should be virtually free of all foreign matter such as pieces of plastic or broken glass. Small inorganic particles, which were missed during the initial sorting, should be sent to the disposal site together with other residues.
- Coarse organic material which has not been completely composted normally remains in the screening residues. This material is a valuable carbon source and should be mixed with fresh incoming waste. It already contains micro-organisms that can accelerate the decomposition of the incoming material.



*Photograph 7.14: Manual flat frame sieve (0.8 m x 1.4 m) on which workers 'rub' the compost through a wire mesh (5 mm mesh size). (Waste Concern, Bangladesh)*



*Photograph 7.15: Manual rotating drum sieve with rectangular drum (15 mm mesh size). Compost is shoveled into the hopper which is feeding the rotating drum sieve. (CompoSieb, jbsART, Switzerland)*



*Photograph 7.16: Motor driven rotating drum sieve for larger amounts of compost (20 tons/day). (Terra Firma, India)*

The screening process generates two fractions: the compost and the screening residues. The particle size and amount of the compost is determined by the mesh size of the sieve through which it passes. For instance, a sieve with a 10 mm mesh size produces:

- fine compost (1 mm up to 10 mm) and
- screening residues containing both coarse organic material and inorganic residues (> 10 mm).

If required, several screens with decreasing mesh size can be put in a row allowing the production of several compost qualities. However, in most cases one compost quality - fine (1-10 mm) - is sufficient.

### **Step 9: Storage and Bagging**

Depending on your customers you might store compost in bulk (delivered loosely) or pack it in bags of different volumes. If compost reheats above ambient temperature after the screening process it still is not completely mature. In this case sprinkle little water and let the compost rest for another week. Check the temperature again before you start bagging it. The compost should be relatively dry when it is bagged to avoid transporting large amounts of water with the compost (moisture content < 40%).



*Photograph 7.17: Compost is filled in woven polypropylene bags, which protect compost from excessive rain but allow penetration of air. (Waste Concern, Bangladesh)*

- Store the mature and screened compost in a dry and covered place. Rainwater would leach out valuable nutrients.
- The storage of compost should not be for longer than two years as the nutrient value of the product and the organic matter content slowly decrease over time.
- Compost is usually sold in bulk or in bags of different sizes (e.g. 5 kg, 10 kg, 40 kg). Some bulk purchasers may like to use a coarser grade of compost if the price is attractive.
- Pack the compost into bags only just before it is to be sold.
- The bags should be waterproof but permeable to air as compost is still a "living" material requiring air. Woven polypropylene bags proved to be very suitable for compost.
- Label the bags. The label should indicate the name and origin of the product, the weight, the date of packing and the average nutrient content of the compost.



*Photograph 7.18: The storage place should be dry and covered by a roof. (Waste Concern, Bangladesh)*

## Activity 2: Trouble shooting

The following table summarises problems during composting and recommends solutions to solve them.

Table 7.1: Possible problems during composting and recommended solutions

| Situation   | Requirements / Possible solutions  |
|---|--|
| <b>1. Raw Material Composition</b>                      |  |
| Large amounts of sand and stones                        | <ul style="list-style-type: none"> <li>improve public awareness to reduce the proportion of inert materials in waste</li> <li>adapt collection vehicle (e.g. by fitting mesh floor) to reduce the sand content</li> <li>remove organics from the mixed waste instead of removing the residues from the organic waste (inverse selection)</li> <li>pre-screening of waste at the composting site with fine mesh size</li> </ul> |
| Large amount of household hazardous waste               | <ul style="list-style-type: none"> <li>improve public awareness to initiate source segregation</li> <li>provide separate collection for hazardous materials</li> </ul>   |
| <b>2. Composting Parameters</b>                         |  |
| Nitrogen deficiency (high C/N value)                    | <ul style="list-style-type: none"> <li>add manure (cow, chicken, buffalo) or urea</li> </ul>   |
| Carbon deficiency (low C/N ratio)                       | <ul style="list-style-type: none"> <li>add wood chips, dry leaves or saw dust</li> </ul>   |
| Too high temperature during thermophilic phase (> 70°C) | <ul style="list-style-type: none"> <li>turn pile</li> <li>water pile if necessary</li> </ul>   |
| Too low temperature during thermophilic phase (< 30°C)  | <ul style="list-style-type: none"> <li>check moisture content, if necessary add water</li> <li>check C/N ratio, add "green" material if necessary</li> </ul>   |
| High moisture content (> 70%)                           | <ul style="list-style-type: none"> <li>turn pile, spread out pile before reforming and leave to dry</li> <li>add sawdust or wood chips for absorbing moisture</li> </ul>   |
| Low moisture content (< 40%)                            | <ul style="list-style-type: none"> <li>spread waste and sprinkle sufficient water</li> </ul>   |
| Odour development (anaerobic conditions)                | <ul style="list-style-type: none"> <li>insufficient oxygen!!! Turn the pile more often</li> <li>if waste is very sticky and compact, mix in coarse material like wood chips to increase aeration</li> <li>if heap is too wet turn it and let dry before re-piling</li> <li>avoid composting meat and fish leftovers</li> </ul>   |
| <b>3. Climatic Influences</b>                           |  |
| Hot and humid climate or high rainfall season           | <ul style="list-style-type: none"> <li>protect waste from getting soaked, use roofed area for composting and maturing</li> <li>cover piles with tarpaulin or composting fleece</li> </ul>  |
| Hot and arid climate or extended dry season             | <ul style="list-style-type: none"> <li>use roof to protect compost from direct sunlight</li> <li>cover with tarpaulin or composting fleece to avoid excess evaporation</li> <li>water more frequently. Collect rainwater and store for dry season if possible</li> </ul>   |
| Frequent strong winds                                   | <ul style="list-style-type: none"> <li>check moisture more frequently as evaporation will be increased</li> <li>cover with composting fleece</li> </ul>  |
| <b>4. Vectors</b>                                       |  |
| Excessive flies, insects                                | <ul style="list-style-type: none"> <li>cover heap with 2 inch layer of coarse compost</li> <li>make sure to receive fresh organic waste (not older than 2 days)</li> </ul>   |
| Rodents and other animals                               | <ul style="list-style-type: none"> <li>protect piles with barrier and fencing (fine meshed chicken wire)</li> <li>cover it with compost fleece held down by stones (see Photograph 6.2)</li> </ul>   |

### Activity 3: Control the quality of compost

First and foremost, the quality of compost is controlled best by controlling the quality of the incoming waste that is to be composted. Only biodegradable waste should enter the process, to avoid visible pieces of plastic or sharp broken glass in the final product. But also invisible pollutants like heavy metals must be avoided. An effective separation of waste before composting also facilitates the process steps like turning and screening. Hence, if you need to improve the quality, start with a better control of the input material and improve the process control.

Secondly, process control, as discussed above, is a crucial factor for good quality compost. Maintain high temperature to inactivate pathogens and weed seeds. An optimum moisture content during composting ensures the maturity of compost and its benefit to plant growth. Complete and precise monitoring reports can improve the confidence of inspectors and customers in the quality of the final product. In European countries quality is mainly controlled by evaluating monitoring reports once the quality has been proved to be good by a certified laboratory. In addition, quality inspectors are authorised to make unannounced spot tests.

Finally, the product needs to be frequently analysed to provide important information about the nutrient contents and invisible pollutants like heavy metals. Figure 7.5 below provides an overview of the most important physical, chemical and biological quality criteria, which are briefly introduced and discussed in this handbook. Annex 8 shows examples of compost quality standards from selected countries.

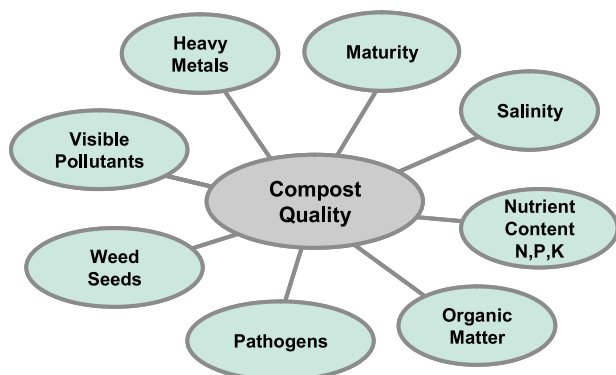

Figure 7.5: Selected quality criteria for compost

- **Visible pollutants** can be easily detected by the end-user. Each piece of glass or plastic shows the user the origin of the material and causes a loss in confidence in the product. Especially glass or metal pieces pose harm to the users and should be strictly avoided. Pre-sorting the incoming waste and avoiding crushers before the composting process result in most of the cases in clean and good quality compost.

- **Maturity** is the most important aspect for horticulture and vegetable production. Compost should be stable, which means that it does not release substances (e.g. ammonia or acidic substances) which can hamper plant growth. The application of immature compost causes root damage, nutrient loss and therefore a reduction in yield. Unfortunately, maturity is difficult to measure; it requires more than one test to assess maturity. The four indicators below allow a rough on-the-spot check of maturity:

- appearance: dark brown, soil like material, no insects or larvae visible
- earthy smell
- if you dig into the compost (storage) heap, the temperature should not exceed ambient temperature
- pH 7 ? 0.5

- **Non-toxicity** means the absence of substances which could harm plants and human beings. Apart from the above mentioned visible pollutants, many toxic substances are invisible. The absence of toxic substances (e.g. organic chemicals or heavy metals) is particularly crucial for the application of compost for food production as many plants are able to take up these substances. Heavy metals play a particular role. Once, heavy metals are detected in the compost, they hardly can be eliminated again. Mixed municipal solid waste can contain heavy metals, but the organic fraction is low in heavy metals. Hence a contamination can largely be avoided by separating the organic waste from other residues prior to composting.

- **Balanced nutrient content** is defined by each customer differently according to the individual needs. Hence, different products are available on the market. Pure compost contains a balanced mixture of Nitrogen, Phosphorous, Potassium, Calcium and other essential micronutrients. It cannot compete with artificial fertilisers in terms of nutrient content but is especially beneficial due to the high content of organic matter and the presence of useful micronutrients. If higher nutrient contents are required, enrichment with other fertilisers is an option. This aspect is briefly discussed in Task 8 (Marketing of Compost) where the nutrient values of different compost products are shown.

#### Who can assist in quality analysis?

Apart from the on-site testing methods that have been described above, additional chemical analyses from laboratories are necessary to determine the nutrient contents. However, it is not justifiable to establish an own laboratory purely for such analyses. Agricultural laboratories typically have the equipment for soil analyses which is also suitable for compost analysis. National Agricultural Research Institutes or Universities could be contacted for a start. For instance in Bangladesh, there are several possibilities:

- Soil Resources Development Institute (SRDI),
- Bangladesh Council for Scientific and Industrial Research (BCSIR) of the Government of Bangladesh,
- Bangladesh University of Engineering and Technology (BUET) and
- Soil Science Departments of any university.

### Further reading

The web page provides a comprehensive list of C:N ratios of waste types including food processing waste which is also suitable for composting.

<http://compost.css.cornell.edu/onfarmhandbook/apa.tab1.html>

Center of Policy and Implementation Studies (CPIS) (1993), "Enterprises for the Recycling and Composting of Municipal Solid Waste: Volume 1, Conceptual Framework", Jakarta, Indonesia

## Task 8



Marketing of Compost

- Identifying Stakeholder Interests : Task 1
- Assessing Target Community Interests and Land Availability : Task 2
- Data Collection : Task 3
- Preparing a Business Plan and Financial Projections : Task 4
- Development and Design of Collection System : Task 5
- Design and Construction of Composting Facility : Task 6
- Operating and Maintaining a Composting Facility : Task 7
- Marketing of Compost : Task 8**

## Task 8: Marketing of Compost

### *To know the road ahead, ask the ones coming back (Chinese Proverb)*

If your composting activities are based on a business approach with little or no external support, assessment of potential markets and customers are key elements for launching a compost business. Yet, even if composting is accepted as a treatment option within a SWM strategy and receives additional subsidies from institutions, a demand for the product should be identified. Before starting compost production, determine for what purpose the compost will be used and decide on the target customers. When asked “who are your customers?” or “who will buy your product?” many entrepreneurs or project coordinators either have no clear idea or they assume that “everyone” will. Such assumptions can lead to wrong decisions and pricing policies, incorrect marketing strategies and finally to business failure. A market demand study aims at identifying compost customers, usages and their demands in terms of both quality and quantity.

A preliminary survey of potential compost markets is described in Task 1, Activity 3. Task 8 will therefore focus on compost marketing strategies, product design and quality requirements. After having finalised the following activities you will know:

- how to apply the “4 Ps” when marketing your compost product
- how to approach and relate with potential customers
- about some potential sales strategies and which may be the most suitable for your business
- about the important quality criteria to ensure satisfied customers and long-term sales

### **Activity 1: Assess potential customers and competitors**

**Potential customers** must either show a need or a want (or both) for compost, including the ability and willingness to pay for it. Consult the fact sheets developed during Task 1. Note that not all criteria are necessary to qualify as a potential customer; however, the ability to pay for compost is vital. The following questions help to structure an assessment of customers.

- Where could compost potentially be used and for what purposes?
- Who are your potential customer groups and what are their different needs?
- What are the potential quantities each customer group would require (potential market demand)?
- What is the ability and willingness to pay of your potential customers?

### **Knowing your competitors**

In addition to knowing your customers, you must also be informed about your competitors and the competing products on the market. Familiarise yourself with the characteristics of the competing products (quality, price, etc.), the methods used by competitors to sell their products and reason why customers buy their products. It will help you understand not only the needs of your potential customers but also how to establish your marketing plan.

Typical competing products for compost are:

- fertile soils mined and transported to the end user (peat, red soil, etc.),
- chemical fertilisers,
- animal waste (chicken manure, cow dung, etc.),
- raw municipal refuse,
- human faecal sludge (from pit latrines and septic tanks) and wastewater sludge,
- nutrient-rich wastes from industrial processing (neem cake, brewery and distillery waste), and
- mined decomposed landfill material.

To compare products, determine the amount of compost required to replace the competing product.

1. Make a list of the competitors
2. Quantify and characterise them
3. Classify them into different categories according to their competing products or targeted customer groups
4. Collect detailed information on them and their products (e.g. products, prices, sales volume, distribution networks, other services)
5. Use direct surveys or collect information indirectly by studying the customers or secondary sources
6. Answer the following questions:
  - What advantages do competitors have over your business or project?
  - What lessons can you learn from them?
  - What advantages do you have over your competitors or competing products?

### **Activity 2: Develop a marketing strategy**

After having obtained a comprehensive view of the compost market demand and condition, it is far easier to develop a marketing strategy. The sale of compost faces several obstacles which threaten the development of a successful overall composting and recycling approach:

- There is an apparent lack of awareness and yet there are numerous reservations regarding compost. Compost often has a negative image due to its input material (waste) and sometimes bad quality



- There is a great lack of knowledge on compost benefits and application
- The nutrient value of compost is often compared with that of chemical fertilisers
- Compost has to compete with low-cost traditional products like manure
- The long distances between production (composting plant) and application (fields and gardens) prevents the sale of compost
- Inadequate or unfair regulations and policies (e.g. subsidies for chemical fertilisers) hinder the composting approach.

## 1. Product

**Product features** must be adapted to the needs of the targeted groups to ensure continuous - or even increasing - sales. Product features are for example:

- Purpose and benefit of the product (e.g. fertiliser, soil conditioner)
- Quality (e.g. maturity)
- Packaging (e.g. bulk or packed products)
- Additional services (e.g. free delivery)

### Using the Marketing Mix

Many marketing professionals rely on the so-called “**4 Ps**” of the **Marketing Mix** to help developing a company’s sales strategy:

|                   |  |
|-------------------|--|
| <b>Product:</b>   | Relates to features, benefits, quality, packaging, presentation but also service and abstract messages such as image or principles.<br><br><b>Example:</b> <i>Compost is produced from organic solid waste and is hence an environmentally friendly and high-quality product. Compost is high in organic matter and, therefore, an important soil amendment for agriculture and horticulture.</i>  |
| <b>Price:</b>     | Is dependent on your customers’ financial circumstances, on compost demand and the prices of competing market products. However, it is also determined by your production costs and expected profit margin.<br><br><b>Example:</b> <i>Compost has to compete with commercial fertilisers and other natural manures. The market price will range somewhere in between these two products, however, production costs have to be covered.</i> |
| <b>Place:</b>     | Can be regarded as a link between your product and your potential customers.<br><br><b>Example:</b> <i>You have decided to market the compost via a retailer who has already established a distribution network for other agricultural products. Customers can purchase the compost locally at low transport costs.</i>  |
| <b>Promotion:</b> | Supports and influences the perceptions and judgements of your potential customers to ensure the sale of your product.<br><br><b>Example:</b> <i>Your compost has an official quality label. The customer opts for your product as he/she trusts the label or is aware of your company’s good reputation, promoted by advertisements.</i>  |

The “4 Ps” are required both for market demand analysis and for sales activities. The four elements generally have to be skilfully combined to ensure the sale of your product. **Product features** and **Price** are closely interrelated but are also greatly influenced by your customers or market. Willingness to pay is determined not only by the compost price or its affordability but also by its handling characteristics. Hence, awareness of potential customers, their attitude towards and experience with the product as well as their personal values should form an integral part of a successful product policy. The components “Place” and “Promotion” are less influenced by customer behaviour but help facilitate the sale of the product.

A marketing strategy is needed to tackle these product-specific obstacles. The risks and opportunities identified in the “window of opportunity” analysis should be taken into consideration (see Introduction).

Marketing professionals focus on four main parameters to attain a successful marketing strategy: **Product, Price, Place, and Promotion**. These are the so-called “**4 Ps**” of the **Marketing Mix**. The following section describes each element and aspect to be considered in detail.

Customer needs have been identified in the market demand analysis. Yet, the product may also include an **extended product feature** or information for the customer. Packaging for example should be of appropriate size for easy use, indicate nutrient content of the compost or provide application guidance for different plants. This is an additional benefit to the customer and can promote repeated purchase of your product.

After-sales **service provided with the product** is a further benefit as it also includes an important product feature and may offer an advantage over competitors. Many fertiliser or

composting companies provide compost consultancy services, thereby also allowing a detailed analysis of customers' needs and product acceptance.

**Product quality** is another key feature in gaining satisfied and loyal customers (see also Task 7). Compost quality criteria can be divided into visible and easily controlled quality criteria or invisible criteria difficult to assess by the customer. Table 8.1 contains selected quality criteria classified into customers' assessments:

Table 8.1: Compost quality criteria and the possibility to be assessed by customers

| Factors possible to be assessed by customers   | Factors impossible to be assessed by customers   |
|--|--|
| <ul style="list-style-type: none"> <li>▪ Colour</li> <li>▪ Smell</li> <li>▪ Visible foreign matter (plastic, glass, wires)</li> <li>▪ Degree of maturity assessed by colour and smell</li> </ul> | <ul style="list-style-type: none"> <li>▪ Nutrient content (NPK)</li> <li>▪ Degree of maturity in terms of chemical constituents</li> <li>▪ Suitability for plants (pH, salt content)</li> <li>▪ Inactivation of weed seeds</li> <li>▪ Freedom from pathogens</li> <li>▪ Heavy metal content</li> </ul> |

Since the customer is not in a position to assess the most important compost quality criteria (e.g. nutrient content) by its appearance, he has to trust the information provided by the producers. Ways to gain customer confidence include intensive process monitoring and quality control conducted by independent laboratories. A compost quality label can also generate customer confidence. However, it will have to be introduced and awarded by an independent regional or national organisation acting as a control institution.

### What is enriched compost?

Compost exhibits a natural nitrogen content of 1-2%, which is low compared to chemical fertilisers or even animal manure. To compete with such products and to meet customer requirements, compost can be enriched with additives (e.g. urea, potash or poultry manure) to obtain a balanced NPK ratio. However, prior to starting with compost enrichment, a detailed market demand analysis should be conducted to ensure regular sales, as investment and production costs for the enrichment may be quite high.

**Example:** Waste Concern promotes the sale of nutrient-enriched compost. It sells mature compost with a nitrogen content of 2% in bulk to a fertiliser manufacturing company (Map Agro). The company grinds the compost and blends it with different additives to adapt the NPK content to the different needs of farmers.

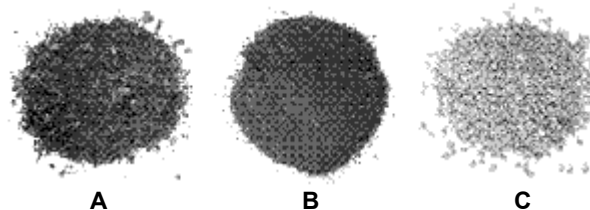

Photograph 8.1: A: Mature compost, B: ground compost and C: amended/granulated compost

Table 8.2 shows a comparison of nutrient contents of two types of compost which are produced from solid waste.

Table 8.2: Comparison of nutrient contents in different composts of Waste Concern

| Nutrient concentration (OM, N, P, K in %) | Compost Products of Waste Concern |                  |
|---|-----------------------------------|------------------|
|   | Conventional compost              | Enriched compost |
| Organic matter (OM)                       | 35 – 40%                          | 30%              |
| Nitrogen (N)                              | 1.0 – 2.0%                        | 7%               |
| Phosphorus (P)                            | 0.4 – 4.0%                        | 7%               |
| Potassium (K)                             | 0.5 – 2.6%                        | 14%              |
| pH  | 7.8                               | 7.5              |

Source: Waste Concern (2001)

Annex 8 provides additional information on quality issues. The tables with the different national quality standards can be used as guidance for your compost quality. However, they differ significantly as the standards relate to the respective local conditions.

**Packaging** of the product has to meet several prerequisites regarding the sales process and needs of producers and customers. Different market segments for compost call for different packaging features, e.g. while agricultural applications require bulk deliveries, horticultural applications favour bagged products.

### Activity 3: Define your product

Answer the following questions:

- What are the needs of your potential customers regarding amount and quality of compost?
- What needs can you cover with your production? (Concentrate on a few markets with high potentials).
- How can you adapt your production process in order for your product features to meet your customer requirements?
- How can you make your customers trust in compost quality—how can it be made attractive to your customer?

- What service can you provide together with your compost product?

#### Example: Product diversification versus market concentration

##### Waste Busters, Pakistan

Waste Busters produces compost from organic waste. It has developed a range of products suited to different market segments. "Offering a variety of different composts increased our sales and developed a larger target market. In addition to compost, we also provide:

- composted mulch material
- topsoil amendment
- nutrient-rich fertiliser-grade compost
- and potting media

We sell it directly to our customers."

(Pervez (2002) in Ali, M. Sustainable Composting, WEDC, 2004 )

##### Waste Concern, Bangladesh

Waste Concern produces compost from pre-sorted solid waste and sells the sieved material to two fertiliser companies in Bangladesh. The fertiliser company amends the compost with nutrients and sells it to farmers through their own distribution network and regional branches.

Hence, Waste Concern adapted the entire composting process and final bulk product to the requirements of their two main customers.

(Rytz, I. (2000), Sandec Report)

## 2. Price

Product pricing is a core issue facing all companies, as many aspects have to be taken into consideration. For a self-sustained business activity, cost coverage is ultimately the most important factor. Hence, product price is dependent on the specific **production costs**. However, a producer will add a profit margin to provide for further investments or technological improvements. The margin is, nevertheless, limited as the prices of **competing products** and the **willingness and ability to pay** of the customers have to be taken into account. If the price per unit fails to cover all costs and to yield a profit for future investments, the business will eventually collapse. In other words, if you realise that your production costs are much higher than the current market prices for the product, and that you are unable to reduce these costs or introduce mechanisms for cross-subsidies (from other products or other income), you should think about changing your business activity.

The **terms of payment** required in order to accommodate the ability and willingness to pay of a customer is a further important factor. (see Table 8.3) Assuming you sell the compost directly to the end users, their income should be taken into consideration. While a household buying small quantities will be able to **pay cash directly**, a farmer ordering larger quantities to prepare his/her field will only be able to pay after harvesting when he/she has generated a cash income from the sale of the crop. In the latter case, a **credit** should be **granted** as it allows the farmer to profit from

compost when he/she needs it and pay for it when funds become available.

Table 8.3: Terms of payment for the sale of compost

| Terms of Payment           |                    |                                 |
|----------------------------|--------------------|---------------------------------|
| Direct payment             | Credit             |                                 |
| Advance payment            | Short-term credits | Long-term credits               |
| Cash payment               | Grace period       | Profit-dependent payment        |
| Invoice payment            | Payment period     |                                 |
| <b>Households, dealers</b> | <b>Dealers</b>     | <b>Farmers after harvesting</b> |

Preliminary pricing should already have been determined when establishing the business plan of the composting project (see Task 4). However, these factors have to be based on the prevailing conditions and adapted accordingly.

## 3. Place

"Place" can be defined as a **link** for product transfer **between buyer and seller**. If the link to your customer is strong enough, and better than his link to rival suppliers, the customer will more likely buy your product. There are several **sales or distribution strategies** that can link a customer to your product. The "Place" in the sales strategy comprises two main aspects – **location and distribution**:

**"Location" refers to your customer's geographic location and your composting site.**

It is crucial for your business to be located in an optimal geographical position in relation to staff availability, supply of raw materials, cost of land and, certainly, location of customers. Assuming that compost is produced in urban areas, certain market segments, such as households or nurseries, may be located nearby. However, since the bulk market is located in peri-urban or even rural areas, distance is one of the main criteria for the sale of compost, especially as it is a material that is required in large quantities. **Distribution strategies** will therefore have to be developed. The markets for compost can roughly be divided into:

- Local markets (e.g. households, nearby nurseries)
- Regional markets (e.g. nurseries, farmers, peri-urban area)
- National markets (e.g. rural agricultural market, landscapers, industries)
- International markets (export to countries in need of organic fertilisers)

The bulky nature of compost and its low market price generally do not allow the serving of national or international markets. However, several examples prove that a national distribution strategy can be successful thanks to already existing distribution networks.

Development of a **distribution strategy** and selection of **distribution channels** are dependent on the available capacity of your organisation (e.g. staff, means of transport).

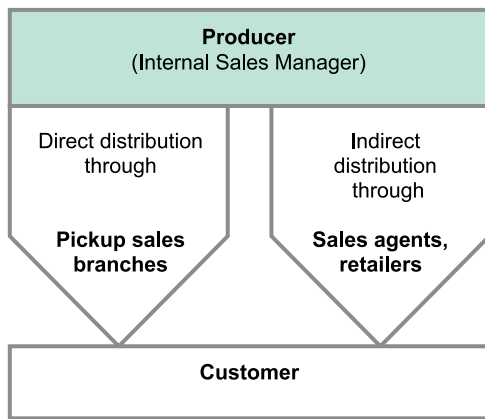

Figure 8.1: Alternative Distribution Channels for Compost

**Direct sales** are suitable if customers are located nearby and known to your organisation. If your customers require large compost quantities, direct delivery may be suitable if you have access to transportation. As transport costs are relatively high, you need to decide whether to include transport costs in the compost price or charge the customer additional costs for delivery.

Another strategy consists in concentrating on compost production and **handing over the sale and distribution to a specialised company**, such as a transport company, trade agent or retailer. Retailers may even change some product features or the packaging, thereby, creating a new product. You lose your direct link to the end user and the retailer becomes your direct customer. Some organisations involved in waste collection and composting combine both strategies. They sell compost directly to nearby customers but also supply retailers on the regional or even national market. They are thus able to focus on their core business of waste collection and treatment. The box below contains two examples of different sales strategies practised in India and Bangladesh.

#### Example: Local versus national sales strategy

| Local sales strategy of Kalyana Nagar Residents Association, Bangalore, India<br>(supported by the Centre of Environment Education (CEE))  | National sales strategy of Waste Concern, Bangladesh  |
|--|---|
| <p>The Association produces up to ten tons of compost from 35 tons of waste per year from neighbouring households. The compost site is located in a low and middle-income household area, some houses having their own garden. The residents are informed through awareness campaigns of the benefits of compost and are so willing to buy it for their garden. Furthermore, households purchase compost to keep public places green. Hence, the scheme concentrates on the local market, thereby allowing distribution of compost through its own waste collectors after receiving the order from the households (Zurbrügg, Drescher 2002).</p> | <p>Waste Concern, an NGO in Bangladesh, produces 300 tons of compost per year in Central Dhaka. Its market is, however, mostly based in rural areas far from Dhaka. It solved its transport problems by joining forces with Map Agro Ltd., a pesticide and fertiliser company, and with Alpha Agro Ltd., a marketing company specialising in agricultural products. These companies have already established national distribution networks to sell their agricultural products in the distant rural markets. Furthermore, they are already well known by the farmers and enjoy their trust and confidence. From the sale of compost to this distributor, Waste Concern is still able to make a profit and does not have to invest in distribution. MAP Agro Ltd. purchases compost from Waste Concern at a rate of Tk 2.5 per kg. After grinding, blending and packaging, Alpha Agro Ltd. sells the final product at a price range of Tk 6 to Tk 8 per kg (US\$ 1 = Tk 50) (Rytz, 2001).</p> |

#### Activity 4: Create a market map

A visual representation of the location of your business in relation to the sources of raw materials and staff, the transport network and customers (markets) can be useful, as it will help you select your customers and adapt your distribution strategy.

- Buy or draw a map of your city and its surrounding area
- Mark the location(s) of your compost production unit(s)
- Locate and indicate the organic waste sources (e.g. vegetable markets and households)
- Locate your customers and indicate the distance to your customers. Use different colours for each market segment
- Assign demand or quality requirements to each customer
- Compare the demands and distribution costs of the different locations.

Such a map can also help to optimise transport routes to enable serving more than one customer during one trip. The distribution network or process should be marked in a separate map to keep the maps as simple as possible.

Consider the following questions:

- When is the appropriate time for distribution and delivery?
- Where do you need to deliver, where are the places of trade?
- What are the available means of transport? How much do they cost?
- Which packaging (if any) is appropriate?

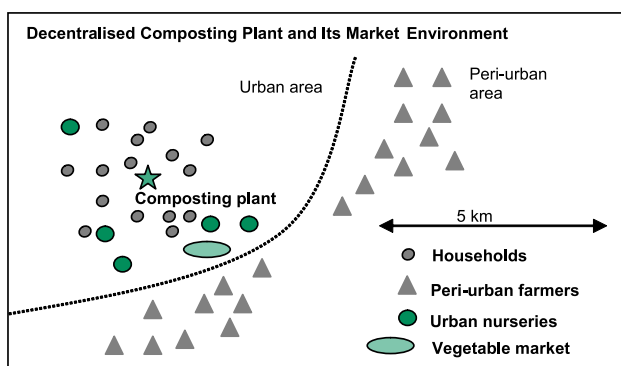

Figure 8.2: Example of a simple map, illustrating the distribution of customers and provision of raw material

Figure 8.2 exemplifies a typical situation in an urban setting, with households, farmers, nurseries, and vegetable markets. The decentralised composting plant is located in an urban setting surrounded by houses. The organic waste originates from households and a nearby vegetable market. Households buy the compost directly back from the plant; however, demand is limited. The nurseries are scattered in the urban area at a distance of 1 to 2 km from the composting plant. They require an individual supply, as they need it at short notice. Some households may be interested in buying the compost from nurseries. In this case, the nurseries could act as retailers for the compost. The peri-urban farmers are located very close to each other along a little stream they use for irrigation. As their demand is of seasonal nature, a fixed distribution date should be

arranged with several farmers to significantly lower distribution costs. Finally, the vegetable market could serve as transfer point for compost. Farmers who come to the market to sell their products will be able to buy and transport compost back to their villages.

#### 4. Promotion

A product does not sell by its mere presence! The potential user has to be informed of its existence and be aware of its benefits. The purpose of promotion is to inform the customers and stimulate product demand. Information will raise awareness of the market and is particularly useful in turning “ability to pay” into “willingness to pay”. Promotion is a vast field that cannot be covered in the context of this handbook. However, experience reveals that demonstration nurseries or demonstration farms can often be very effective in promoting compost. Farmers can see directly the effect of compost on plants and how it is used. Table 8.4 contains an overview of possible starting points for promotion campaigns and promotion tools.

#### Typical pitfalls in the commercialisation of compost

You must observe the golden rule of marketing - **customers should always be satisfied!** Learn from the successes and failures of competitors within the entire marketing field. However, avoid the “me too!” strategy where you try to copy someone else. If you do not come up with new ideas, you will always lag behind your competitors. Table 8.5 gives some useful hints.

Table 8.4: Type of promotion campaigns and tools

| Tool                                   | Description   |
|--|---|
| <b>Direct contact/customer service</b> | Face-to-face selling is the most direct contact to the customer. It allows the seller to inform a customer and to react directly to perceptions and behaviour. This method is very time-consuming and staff-intensive. It may be a suitable approach when starting up a business and penetrate a new market.  |
| <b>Word-of-mouth advertising</b>       | One customer recommends and praises a product to another on the basis of his/her own experience. This is often the most important communication method with customers and also less time-intensive than face-to-face selling. However, if your product is unsatisfactory, even for a short period, the word-of-mouth strategy can also be powerful in lowering the reputation of your product and business.   |
| <b>Advertising</b>                     | Advertising uses mass communication media such as newspapers, television, radio, billboards etc. It is less time-intensive, but should be conducted professionally and requires considerable financial resources.   |
| <b>Internal distribution</b>           | The employees of an organisation can also act as links to potential customers. Encouraging employees or associated organisations to use and promote compost in their own environment can help to spread the information and raise awareness (e.g. among associated NGOs, community associations, schools, and clubs).   |
| <b>Training</b>                        | Training can also be classified as a face-to-face sales strategy; however, it goes beyond the mere sale of a product. It is also time-intensive but has a significant impact on a specific target group. This is especially true for the sale of compost. Training farmers on compost application sells an additional service along with the product. The farmers acquire a broader knowledge of compost and its effects, which will in turn be spread to other neighbouring farmers. Hence selection of farmers to be trained is one of the most vital tasks if conducting training courses. |
| <b>Free samples</b>                    | Free compost samples allow farmers to test the product without taking great financial risks. In combination with a training course, this may be a very effective promotion strategy for compost. However, farmers should be informed that free samples are only distributed once, since compost is a valuable product that has to be purchased.   |
| <b>Exhibition</b>                      | Exhibitions in trade fairs that attract specific target groups are generally cost-intensive. NGOs often have the opportunity to participate in congresses or religious festivals where they can present their activities and products.  |
| <b>Packaging</b>                       | As already mentioned, packaging serves several purposes. For promotional purposes, it plays a key role as it also transfers messages beyond the printed information. In addition to a trade name, colour, cleanliness, stability of the packaging or even condition of the truck for bulk delivery, it can also indicate quality and build confidence.  |

Table 8.5: How to avoid marketing pitfalls

|                  |  |
|------------------|--|
|                  |  |
| <b>Product</b>   | Promise only product features you can actually offer. "It is commonly known that a satisfied customer will only tell one person about a product, but an unsatisfied customer will tell ten"!   |
| <b>Price</b>     | You may try to enter a market with a low-price compost product to win customers from your competitors. However, BEWARE: a low price is often associated with low quality and could damage your reputation. Furthermore, it will be rather difficult to raise your price at a later date to cover production costs.                 |
| <b>Place</b>     | When first selling compost, concentrate on easily accessible markets. Calculate the exact costs and benefits of your distribution options. It is generally cheaper to hand over compost distribution to an expert than to run your own transport fleet.  |
| <b>Promotion</b> | The desire for effective promotion entails the risk of overspending. Choose appropriate promotion activities and concentrate on those that target your specific market segments. Public relations and the raising of general awareness for the compost product could possibly be conducted in collaboration with your competitors. |

### Further reading

Tyler, R.W. (1996): Winning the organic game. The compost marketer's handbook. ISBN 0-9615027-2-X. The book is mainly focused on compost markets in America, however it describes the principles of marketing and introduces many market sectors which are also relevant for developing countries.

Skat Consulting (2002): Building sustainable supply chains to bring affordable technologies and services to rural areas - Workshop report on distribution chains (in French language) and Resource CD (English, German), Niamey, St. Gallen. ([www.skat.ch](http://www.skat.ch))

Waste Concern (2001): "Research Report on Application of Compost on Soils of Bangladesh" field experiment report prepared for the Sustainable Environment Management Programme (SEMP), of the Ministry of Environment and Forest and UNDP.



## Annex





|  |                 |
|--|-----------------|
| Overview – Timetable for Planning and Implementation :   | <b>Annex 1</b>  |
| Basics of Statistical Analysis for Community Surveys :   | <b>Annex 2</b>  |
| Questionnaire for Community Surveys :  | <b>Annex 3</b>  |
| Layouts of Two Composting Plants :   | <b>Annex 4</b>  |
| Template for Both a Memorandum of Understanding (MoU) and<br>a Final Contract Between the Involved parties : | <b>Annex 5</b>  |
| Analysis of Waste Generation and Physical Composition as<br>Conducted by Waste Concern in Bangladesh :       | <b>Annex 6</b>  |
| The Science of Composting :  | <b>Annex 7</b>  |
| Compost Quality Standards :  | <b>Annex 8</b>  |
| Templates for Compost Monitoring :   | <b>Annex 9</b>  |
| Preliminary Compost Application Guide :  | <b>Annex 10</b> |
| Definitions and Glossary :   | <b>Annex 11</b> |
| Authors and Reviewers :  | <b>Annex 12</b> |



## Annex 2: Basics of Statistical Analysis for Community Surveys

To obtain conclusive results regarding future system design and to avoid biased answers, the survey should cover a certain number of households randomly selected from among all income groups of the community. Calculation of sample size ( $n$ ) is based on general statistical methods like the ones described by Salant, (1994) and Rea, (1997) and on the equation below:

$$n = \frac{t_p^2 * p * (1 - p) * N}{t_p^2 * p * (1 - p) + (N - 1) * y^2}$$

where  $N$  stands for population size,  $y$  for sampling error,  $p$  for the true proportion set as 0.5 and  $t_p$  is equal to 1.96 for 95% confidence level.

Sampling errors represent the differences in the results one obtains when looking at a portion or sample of a population instead of the entire population. If you were to question every single person in a population, the sampling error should be zero, provided that all person questioned answered truthfully. Similarly, if you were to collect and analyse all the waste generated in one population, the sampling error should be zero, provided that all your measurements and analyses are correct.

If the resulting sample population size exceeds 50% of the total population, the required sample size can be reduced to 50% of the population size.

As the calculation is quite time consuming Table 2.1 provides already calculated sample sizes under pre-defined sampling errors for household surveys. This table can give guidance on the number of households to be assessed to obtain reliable results. However, selection of sample size and acceptable sampling errors depend on the time and manpower available for such a study.

Table 2.1: Calculation of sample sizes for household surveys

| Total number of households in the community | Required sample size allowing a 95% confidence level |                |                |
|---|--|----------------|----------------|
|   | ? 5%   | ? 7%           | ? 10%          |
|   | Sampling error                                       | Sampling error | Sampling error |
| 100   | 50   | 50             | 49             |
| 250   | 152  | 110            | 70             |
| 500   | 217  | 141            | 81             |
| 750   | 254  | 156            | 85             |
| 1,000                                       | 278  | 164            | 88             |
| 2,500                                       | 333  | 182            | 93             |
| 5,000                                       | 357  | 189            | 94             |
| 10,000                                      | 370  | 192            | 95             |
| 25,000                                      | 378  | 194            | 96             |
| 50,000                                      | 381  | 195            | 96             |
| 100,000                                     | 383  | 196            | 96             |
| 1,000,000                                   | 384  | 196            | 96             |
| 100,000,000                                 | 384  | 196            | 96             |

If the total number of household lies between two given values, choose a sample size between the corresponding sample size values (interpolation).

### Further Reading

Rea Louis, M. and Parker, R. A (1997): Designing and Conducting Survey Research- A Comprehensive Guide, 2. Edition, Josse-Bass Inc. Publishers, San Francisco

Salant, P. and Dillmann, D. A (1994): How to conduct your own survey. Jon Wiley & Sons Inc., Toronto

### Annex 3: Questionnaire for Community Surveys

Apply this questionnaire for an anonymous survey among a target community. It assesses the existing waste management practices and the improvement wished by the community members. Depending on the local conditions some changes may be necessary (see indications in the table below).

| <b>1. Is there any service provided by the city corporation for solid waste management in your area?</b> |  | <b>YES</b>   | <b>NO</b> |
|--|--|--|-----------|
| 1.1  | If YES, are you satisfied with the present waste removal system:                                   | (a) Very good<br>(b) Good<br>(c) Ok/medium<br>(d) Not satisfactory   |           |
| 1.2  | If YES, how often do the city corporation workers collect the waste?                               | (a) Every day<br>(b) Once in two days<br>(c) Once in three days<br>(d) Weekly<br>(e) Other frequency.....<br>(f) Irregularly<br>(g) Don't know<br>(h) Not applicable   |           |
| <b>2. Are you satisfied with your current solid waste disposal system in your community?</b>             |  | <b>YES</b>   | <b>NO</b> |
|  | If NO, what are the problems you are facing for disposing of your waste?                           | a) No waste container in the area<br>(b) Container is quite far away<br>(c) Container is not in a convenient place<br>(d) Container is not in the way of movement<br>(e) The area around the container is dirty<br>(f) No one is at home to hand over the waste  |           |
| <b>3. Do you think the current waste disposal system in the area is polluting the local environment?</b> |  | <b>YES</b>   | <b>NO</b> |
|  | If YES, identify the reasons:  | (a) As there is no container nearby, wastes are dumped here & there and create nuisance.<br>(b) Waste is left on the road and in green areas.<br>(c) Waste is not collected regularly and containers overflow.<br>(d) Scattered waste around the container is not collected.<br>(e) Wastes are left in the drain.                          |           |
| <b>4.</b>  | <b>How much money are you currently spending for waste disposal or waste collection per month?</b> |  |           |
| <b>5.</b>  | <b>How many persons live in your household?</b>  |  |           |
| <b>6.</b>  | <b>What is the total monthly income of your household?</b>   |  |           |
| <b>7.</b>  | <b>Who disposes of your household waste?</b>   | (a) Servant<br>(b) Family member<br>(c) Waste is collected by workers of the city corporation from the house<br>(d) Waste is collected by a locally-recruited person from the house  |           |
| <b>8.</b>  | <b>Which system do you prefer for removal of your household waste?</b>                             | (a) A collector will collect the waste from the house.<br>(b) The collector will come to a certain place at a certain time, you will give him the waste<br>(c) You yourself will put the waste in the container<br>(d) You will leave your waste container at a certain time by the roadside and the collector will collect it from there. |           |

- 
9. If, in future, your waste is collected directly from your house, then how often should it be collected?  
(Remember that a more frequent service will be more expensive.)
- a) Everyday
  - (b) Once in two days
  - (c) Once in three days
  - (d) Other.....
- 
10. If, in future, your waste is collected directly from your house and you have to pay additionally for it, how much are you ready to pay monthly for the service?
- Here no categories can be prepared as it strongly depends on the local conditions. Two options are possible: let the interviewed person state any amount or suggest ranges, starting with the highest and reducing the amount stepwise until the respondent indicates willingness to pay such a sum.*
- 
11. When would you prefer for your waste to be collected?
- (a) Morning (before 9.00)
  - (b) Morning (after 9.00)
  - (c) Noon
  - (d) Afternoon
  - (e) Evening
-

## Annex 4: Layouts of Two Composting Plants

Both layouts are designed for a composting plant treating up to five tons incoming mixed household waste and composting three tons of organic waste. The layout supports the workflow of the composting process. Waste is delivered directly to the sorting platform from where it is transferred either to the composting area, the recycling storage or the storage of rejects. The screening area is nearby as well as the storage area for compost.

### 4A: Windrow - composting system, layout plan

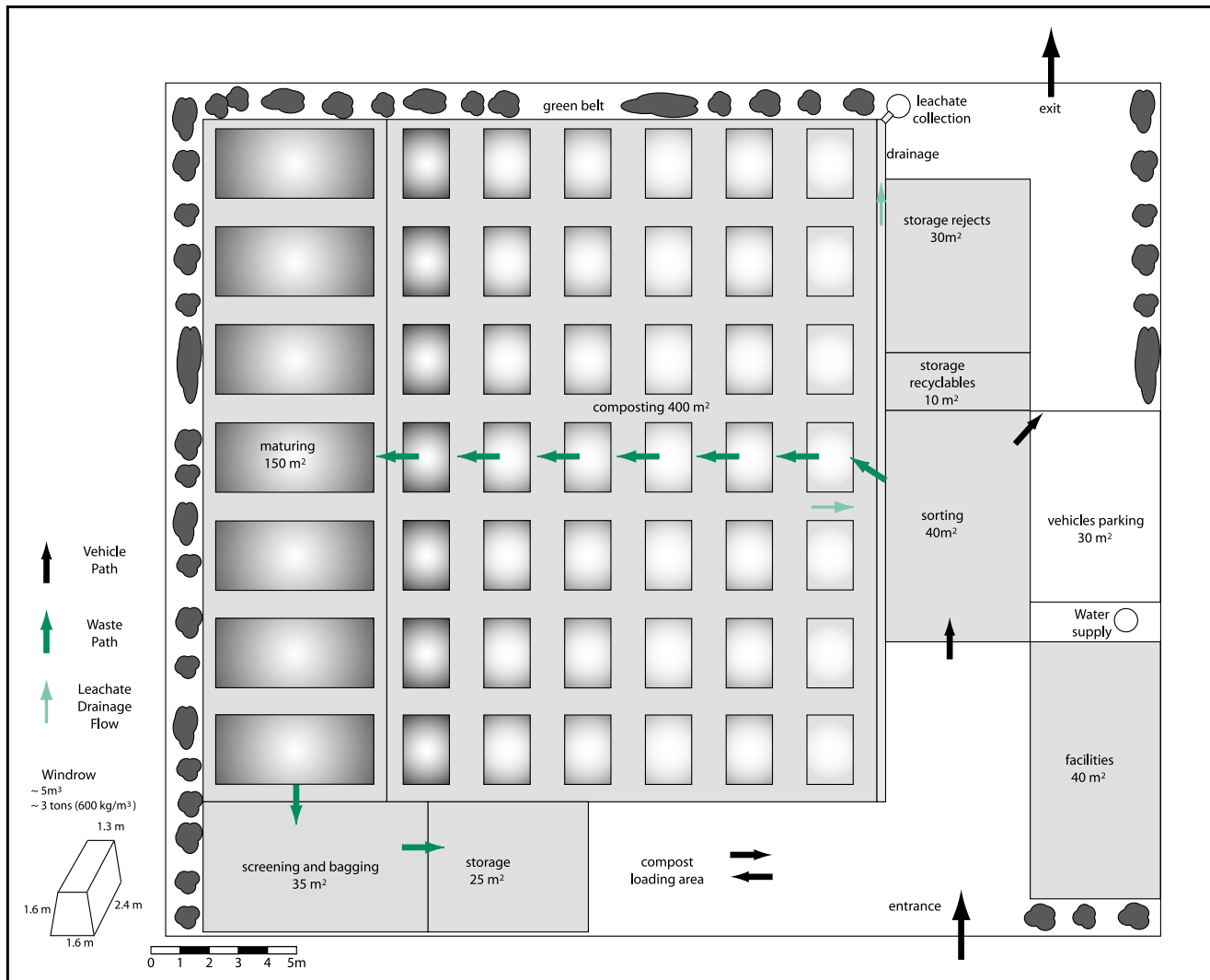

4B: a) Box - composting system, layout plan

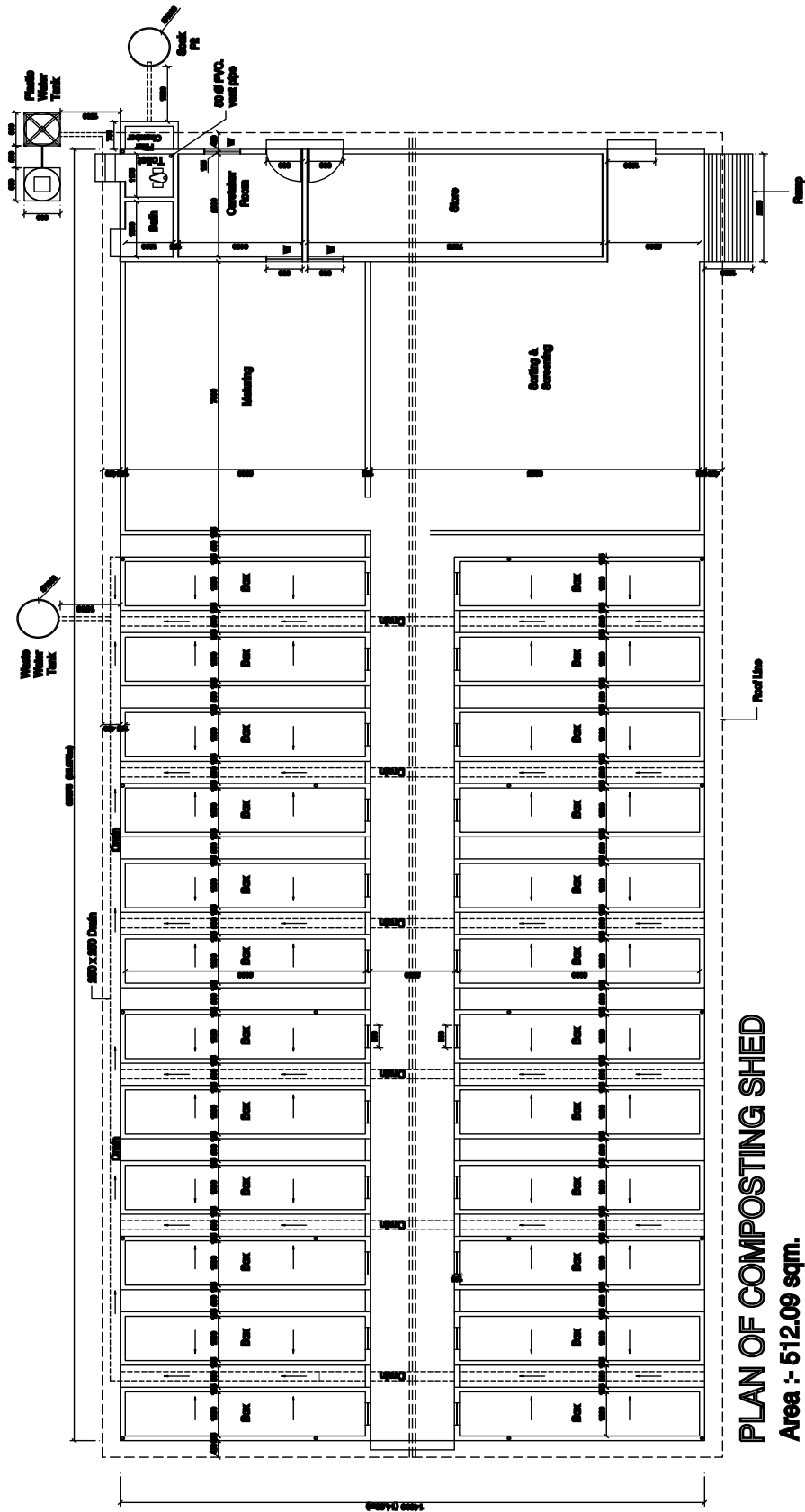

**PLAN OF COMPOSTING SHED**

**Area :- 512.09 sqm.**  
**(All Dimension In mm.)**

4B: b) Box - composting system, cross section view

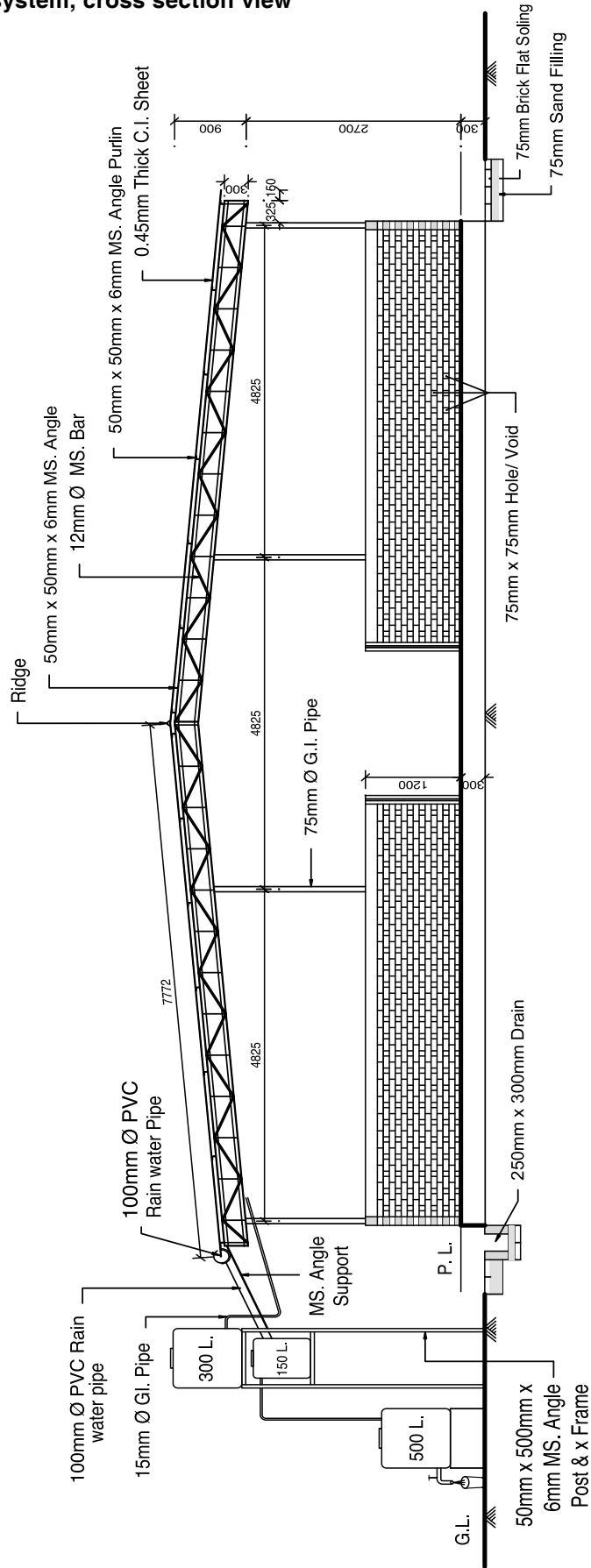



#### 4C: Details of box composting system

**a. Schematic air supply and drainage system (cross section).** Important features: aeration gaps in the box walls, one front wall is open but blocked with removable wooden slats, vertical vent pipes, perforated bottom grid and drainage system (Waste Concern, Bangladesh)

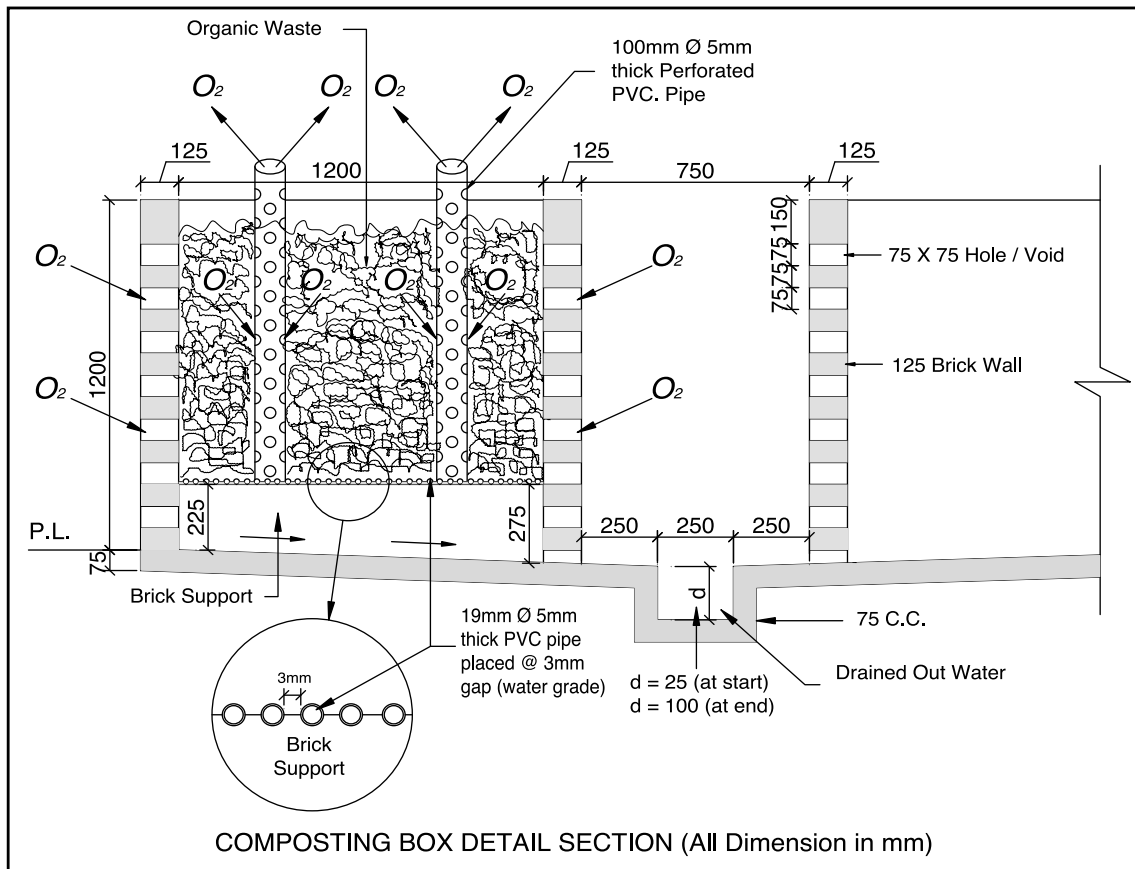

#### b. Drainage channels (layout plan) and dimensions of vertical pipes (right)

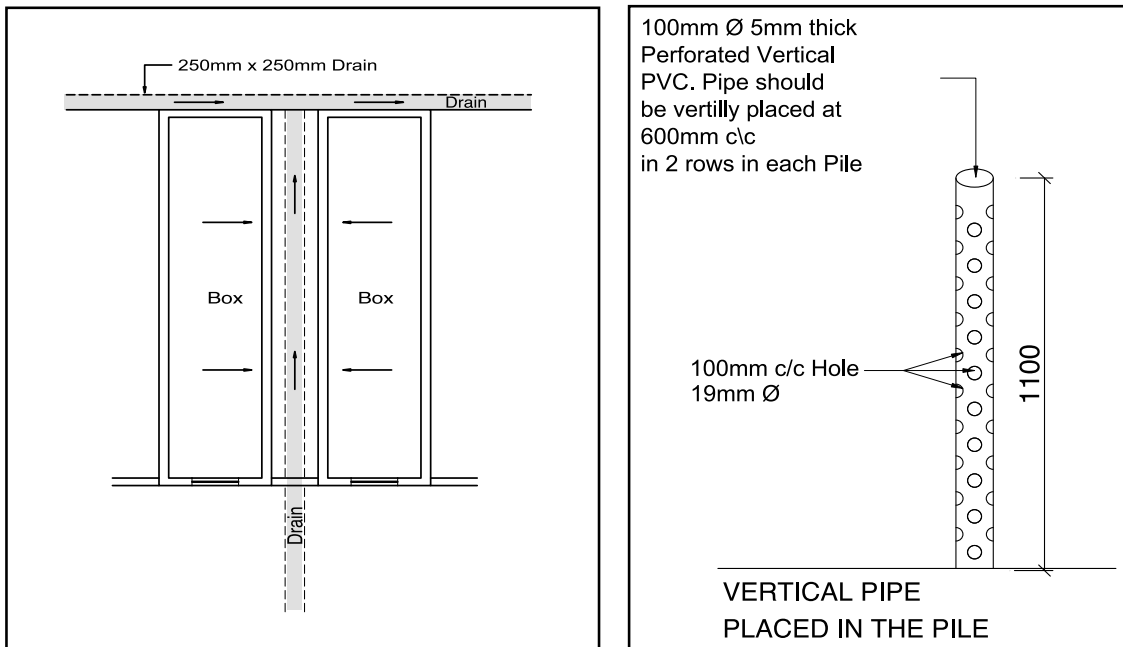

**c. Bottom level drainage grid construction with PVC pipes of the compost box**

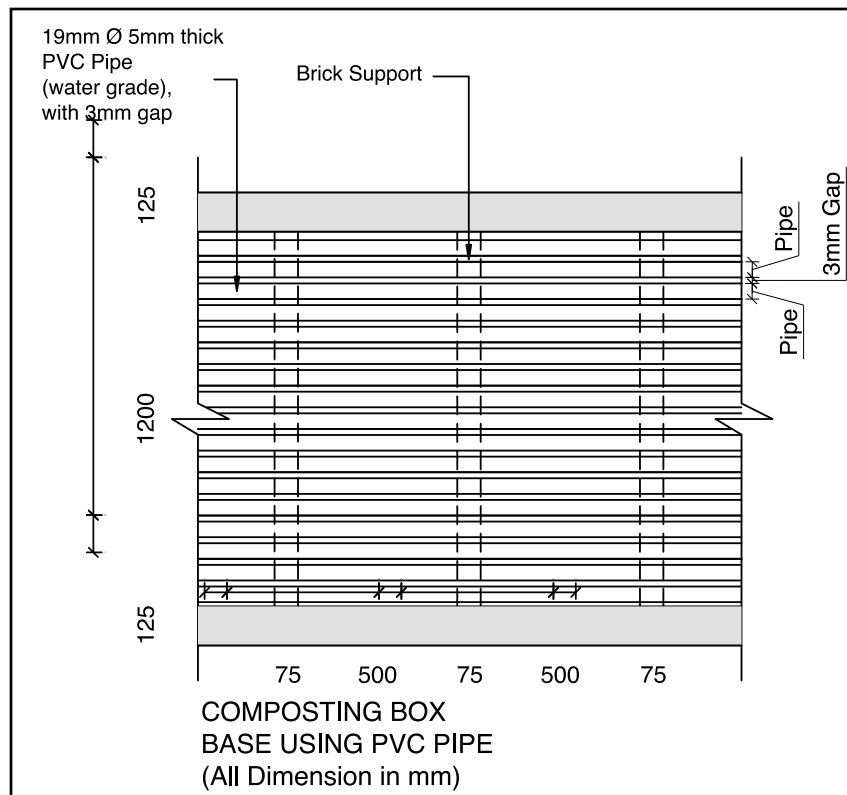

**d. Bottom level drainage grid construction with MS rod grid (birds view)**

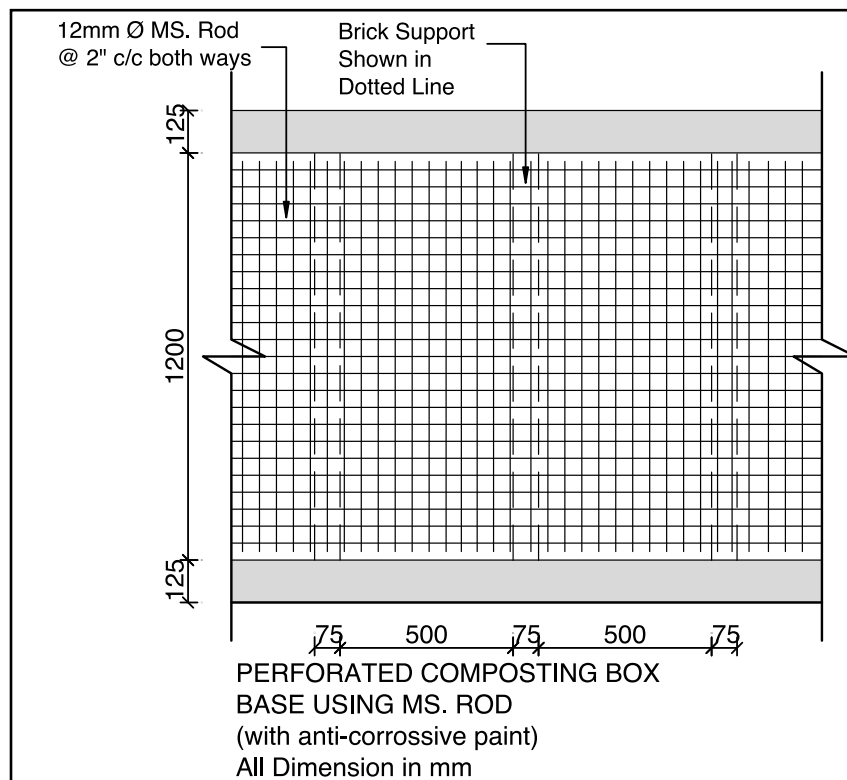

## Annex 5: Template for Both a Memorandum of Understanding (MoU) and a Final Contract Between the Involved Parties

For developing a MoU only consult the parts Introduction, Part A (Scope of Cooperation) and Part B (Project Period)

For the final contract add Part C and Part D which shall define the detailed tasks and responsibilities of the parties involved (the gaps to fill in are in italic letters). In any case seek advice from a solicitor helping to adjust the MoU to the local legal conventions.

### Memorandum of Understanding (MoU)/ Contract

between

**Function of Person, Division and Company/ Municipality.**

and

**Initiator (person or organisation)**

This Memorandum of Understanding (MOU) on Implementation of "*Project Name*" is made this *Date* at *Location/City* between:

*Function of Person, Division and Company/ Municipality* (hereinafter referred to as the FIRST PARTY) and represented in this document by the *Function of Person* or his authorized nominee. *Address*

AND

The *initiator* (hereinafter referred to as the SECOND PARTY) and represented in this document by its Project Coordinator of the "*Project Name*", with legal address of *Address*.

The subject of agreement is the cooperation of the mentioned parties in the implementation of the "*project name*"

*Brief background information on relevant solid waste management programmes (national or municipal) to justify the project.*

WHEREAS the "*Project Name*" (hereinafter referred as the Project) aims at demonstrating that urban solid waste can be made of benefit by recycling and resource recovery (composting).

WHEREAS the SECOND PARTY is desirous to implement the project, using garbage generated in the municipal areas of (*enter the area/ community you want to work with*) and the FIRST PARTY is willing to accord permission for the same;

WHEREAS *name and function of main responsible person* of the SECOND PARTY grants the SECOND PARTY his kind permission for use of *size of area (e.g. 800 m<sup>2</sup>)* of land and the operation of the project.

Now, THEREFORE in consideration of the agreed premises stated above the FIRST PARTY and the SECOND PARTY mutually agree as follows

#### A. Scope of Co-Operation

The programme of co-operation between the FIRST PARTY and the SECOND PARTY includes the following:

- 1) The proposed land is only be used for the project and not for any other purpose. The land is used for a composting plant with a capacity of treating *number* tons of mixed household waste/ day.
- 2) The project's emphasis is on recycling and resource recovery (composting) in the aforesaid area/ community.
- 3) Conducting training and awareness raising activities on proper solid waste management, recycling, resource recovery in the aforesaid area/ community.
- 4) Annual documentation of the project's activities, costs and benefits

## B. Project Period

The term of the MoU shall be for a period of *number* years from the date of its signing. This MOU represents and constitutes the entire agreement between the parties and may be modified due to change of circumstances or due to any unforeseen factor by mutual consent of the parties.

## C. Responsibility of the First Party

- 5) The FIRST PARTY shall closely co-operate with the SECOND PARTY enabling them to fulfill the objectives mentioned above.
- 6) The FIRST PARTY shall allow the SECOND PARTY to implement the project on *size of area e.g. 800 m<sup>2</sup>* vacant land. *Insert a definition of area/ address of area shall be provided for number years without any rental fee. (or define the fee agreed on)*
- 7) The FIRST PARTY shall allow the SECOND PARTY to use the lands for *number* years from the signing date of this MOU.
- 8) The officials of the FIRST PARTY shall have the power to visit and inspect the project site any time as they wish.
- 9) The FIRST PARTY shall have the power to terminate the project within a 30 days notice if any of the terms of this MOU are breached and no compensation will be given to the SECOND PARTY. SECOND PARTY shall have no right to challenge the order/decision of the FIRST PARTY to any court.
- 10) If possible, The FIRST PARTY shall allow to take water and electricity connection from the nearby facilities to the SECOND PARTY. In this regard necessary permission from *name institutions* have to be arranged by the SECOND PARTY. Also connection charges and the operating cost shall be borne by the SECOND PARTY.
- 11) The platform, water reservoir and roofed infrastructure for the composting purpose can be constructed in the project site and the layout design shall have to be approved by the FIRST PARTY.
- 12) The FIRST PARTY contributes once with *number and currency* to the start up of the project. *(this issue needs to be discussed as in many cases a contribution is not granted.)*

## D. Responsibility of the Second Party

- 13) The SECOND PARTY shall establish a composting plant with a capacity of treating *number* tons of mixed household waste/ day on the land designated by the FIRST PARTY.
- 14) The SECOND PARTY shall bear all the expense of the total project including cost of rickshaw vans for the waste collection, construction and operation of the project and appointment of people.
- 15) The SECOND PARTY shall bear all the expense of the project for resource recovery (composting) and recycling and door to door solid waste collection.
- 16) The SECOND PARTY may be allowed to collect fees for the improved door-to-door waste collection service from the household (the fee will not exceed *number and currency/ month/ household*). The SECOND party has no legal means to force the households to pay the fee but can rely on the support from the FIRST PARTY helping to settle the dispute.
- 17) The SECOND PARTY shall provide necessary security and guard for the project during the project period.
- 18) The SECOND PARTY shall provide visual protection of the composting plant by planting saplings and fast growing bushes along the borders of the plot. The compost produced can be used for that purpose.
- 19) The SECOND PARTY shall keep the revenues from the waste collection fees and the compost sale to cover the operation and maintenance of the composting scheme. If there is any other income generated from the project, it shall also contribute to the maintenance of the plant.

- 20) The SECOND PARTY shall conduct an awareness raising workshop for the community. Furthermore, the SECOND PARTY shall be responsible conducting a training programme for the party taking over the management and operation of the scheme in the long run.
- 21) The SECOND PARTY shall hand over the project to the FIRST PARTY, a Community Based Organisation (CBO) or another party signing responsible after *number* years of operation. The contract can be prolonged for another fixed period of time, if all parties involved agree.

In WITNESS HEREOF, the parties have made this Memorandum of understanding in two originals containing 3 (three) pages each and signed at the day and year first written above.

Date and Place

*Name*  
*Function*  
for and on behalf of  
FIRST PARTY

*Name*  
*Function*  
for and on behalf of  
SECOND PARTY

Witnesses:

*Name*  
FIRST PARTY

*Name*  
SECOND PARTY

*Name*  
FIRST PARTY

*Name*  
SECOND PARTY

*Note: This format is based on actual MoU/Contract documents used by Waste Concern in different projects in Bangladesh.*

## Annex 6: Analysis of Waste Generation and Physical Composition as Conducted by Waste Concern in Bangladesh

Municipalities and city corporations in Bangladesh mainly generate domestic, commercial and industrial solid waste. However, no reliable data is available on the daily amount of waste generated in the jurisdictional areas of the municipalities or city corporations. Studies show that (*Cointreau, 1982*) the countrywide waste generation rate in the cities and towns of low-income countries varies between 0.4 kg/cap/day and 0.6 kg/cap/day. The difference in rates between small towns and large cities is primarily dependent on the commercial activity of the two - large cities have higher waste generation rates due to their greater commercial activity.

According to studies conducted by the *National Environmental Engineering Research Institute (NEERI)* of India, waste generation rates are lower in smaller towns and higher in large cities. The rates that were measured varied between 0.2 kg/cap/day and 0.5 kg/cap/day. The following table shows the waste generation rates in some Indian cities with 100000 to more than 5000000 inhabitants.

Table 6.1: Per capita waste generation rates in Indian cities

| Population range  | Average per capita waste generation rate (kg/day) |
|-------------------|---|
| 100000 - 500000   | 0.21  |
| 500000 - 1000000  | 0.25  |
| 1000000 - 2000000 | 0.27  |
| 2000000 - 5000000 | 0.35  |
| 5000000 +         | 0.50  |

Source: Report of the Committee constituted by the Honorable Supreme Court of India. Solid Waste Management Rules in Class 1 Cities of India, India 1999.

An analysis of major solid waste categories in cities of developing countries indicates that the residential waste fraction of the total refuse ranges between 60 and 80 percent. According to domestic waste accounts for 75 percent of the total waste generated in Indian cities.

*Cointreau. S.J. (1982)*, "Environmental Management of Urban Solid Waste Management in Developing Countries: A Project Guide", The World Bank: Washington, D.C.

The following waste densities were observed at different stages of the waste management chain in Bangladesh:

Table 6.2: Waste density at different points

| Point of collection chain                       | Average waste density (kg/m <sup>3</sup> ) |
|---|--|
| Pick-up point/communal bin (primary collection) | 350 - 450                                  |
| On truck (secondary collection)                 | 600  |
| Landfill site (compacted)                       | 1100                                       |

Since waste density varies according to season and municipal area, secondary data should be used with reasonable care. Determine at which point of the collection chain measurements were made. The following assessment guideline focuses on primary collection data and can be applied either in one area or for the entire city.

### 1.1 Assessment procedure for solid waste generation and physical composition

#### Main objectives of a waste generation and composition study:

- To determine the volume required for on-site storage, primary collection and transfer facilities.
- To identify potentials for solid waste recycling and resource recovery.

#### Data collected from the survey can be used to:

- Determine the daily residential waste generation rates in kg/cap/day, and in kg/m<sup>2</sup>/day for commercial and institutional waste.
- Calculate the waste density.
- Determine the waste composition in percentage by weight.

## 1.2 Selection of sampling area and timeframe of the survey

- Select residential areas with different socio-economic population groups (low, middle and upper income groups).
- Select the number of households for each residential area in compliance with Table 2.1 in Annex 2 of this Handbook.
- Identify a predominantly business area with a large number of shops and offices.
- Select up to 50 shops and offices to assess the business area.

Collect the waste generated in these areas once a day at a fixed time for eight successive days to allow for weekly variations (the first-day's sample has to be discarded as it may contain waste accumulated over two or more days).

## 1.3 Equipment required

- One handcart or rickshaw van of 1.0 cubic meter capacity for waste collection.
- A number of sacks or bags for sample collection (old rice or potato sacks can be used but also plastic bags are suitable). The number of required sacks can be calculated as follows, but the amount can be significantly reduced if the households are willing to use the bags a second time:

$$Number = 8days * (number_{households} + number_{shops} + number_{offices})$$

- Weigh 10 empty sacks to determine the average weight of one empty sack.
- Tape or rope to tie the neck of the sack/bag to prevent the waste from falling out.
- Sufficient labels to tie to the bags to identify the area where the sample was collected.
- 1 scale to weigh the sample in the sack.
- Sufficient recording sheets.
- Shovels, gloves, masks.
- 1 container of known volume (20 – 50 litres) and weight to measure the waste volume and also for use as a weighing container.
- 4-6 buckets for waste sorting.
- 1 plastic sheet for waste analysis (4-6 m<sup>2</sup>).

Table 6.3a: Data sheet to record the daily waste generation rate (kg) from households

| ID No. of house | Family size          | Day 1 (kg)       | Day 2 (kg)       | Day 3 (kg)       | Day 4 (kg)       | Day 5 (kg)       | Day 6 (kg)       | Day 7 (kg)       | Total (kg)  |
|-----------------|----------------------|------------------|------------------|------------------|------------------|------------------|------------------|------------------|-------------|
| 1               |                      |                  |                  |                  |                  |                  |                  |                  |             |
| 2               |                      |                  |                  |                  |                  |                  |                  |                  |             |
| 3               |                      |                  |                  |                  |                  |                  |                  |                  |             |
| ...             |                      |                  |                  |                  |                  |                  |                  |                  |             |
| Total           | Total family members | Mass daily waste | Mass daily waste | Mass daily waste | Mass daily waste | Mass daily waste | Mass daily waste | Mass daily waste | Total waste |

## 1.4 Method of waste collection and analysis

Repeat the steps below every day throughout the study.

- Provide sacks/bags to the selected households, explain the aim of the study and ask the households to store their waste in the sacks/bags provided.
- Collect the sacks/bags from the houses and shops/offices every day according to the predetermined collection route label the bags. For efficient collection, the workers may have to collect the sacks/bags and deposit them at certain points prior to loading them onto the truck.







### Future projections

For the following calculation you require the current number of population in the project area ( $pop$ ) and the per capita waste generation ( $capwaste$ ). In the event of population growth, first calculate the future population projected ( $pop_{fut}$ ) with the following equation with  $r$  = annual growth rate and  $n$  = number of years:

$$pop_{fut} = pop * (1 + r)^n$$

For example, the equation with a growth rate of 3 % and a projection of 5 years is as follows:

$$pop_{fut} = pop * (1 + 0.03)^5$$

Use the following equation to predict the total waste generation ( $waste_{tot}$ ):

$$waste_{tot} = pop_{fut} * capwaste$$

If assuming a future increase of per capita waste generation ( $capwaste_{fut}$ ) (e.g. by a change of consumption patterns), calculate the future waste generation ( $waste_{tot}$ ) using the following equation:

$$waste_{tot} = pop * capwaste_{fut}$$

## Annex 7: The Science of Composting

### Basics of composting

In natural environments, the slow decomposition of organic matter by different microorganisms and invertebrates produces a black-brown earthy material called humus – a valuable component of good soils. Composting runs along the same lines, but is accelerated by optimised and controlled process parameters like input material, temperature, moisture, and pH. This distinguishes composting from natural decomposition. The quality of the input materials, and certain biological and physical parameters have a major influence on the quality of the compost and on the occurrence of operational problems with the composting facility. A properly constructed compost pile can be compared to an interactive biological and ecological system. It contains various microorganisms dependent on the nutritional and environmental condition of the pile. It is important for composters to understand the physical, chemical and biological processes involved in the decomposition of biodegradable organic material. Any well managed compost heap contains water and air in the pore spaces between the solid particles as shown in Figure 7.1.



Figure 7.1: Compost contains solid, liquid and gaseous phases – all play an important role during composting

The solid material is the biodegradable waste, the moisture inside and outside of the waste is the liquid part and the air in the gaps between the solid particles the gaseous phase. All three constituents play a key role in the composting process, as the main activity of microorganisms can be observed at the interfaces of these three phases. Microorganisms can only make use of dissolved nutrients found in the liquid phase. However, they require oxygen for their metabolism, which they draw from the air in the gaps.

### Aerobic “hot” composting

The composting process can be divided into three phases:

1. Degradation phase
2. Transformation phase
3. Synthesis or maturation phase

As natural microorganisms such as bacteria, actinomycetes, fungi, and some protozoa are already present in organic waste, the **degradation phase** starts directly after piling. These aerobic microorganisms degrade carbohydrates and amino acids present in food and yard waste into simpler compounds, carbon dioxide and water. Under favourable conditions, they multiply exponentially and generate a large amount of heat as a result of oxidative processes. The temperature within the heap rises to over 60°C. If high temperatures are maintained for one week, and all of the material experiences such temperatures (the cooler outer layer being relocated to the warm interior as a result of the turning process) pathogens and weed seeds are destroyed during this phase. To ensure a favourable environment for aerobic microorganisms, it is important to control the oxygen supply during this phase. After about one month, the process slows down and temperatures drop slightly. Different species of fungi become predominant in the compost pile and develop a white or grey colour just under the surface of the compost heap. Fungi are important for the decomposition of proteins and cellulose substances. During this phase, the compost process has to be controlled and adjusted frequently to ensure optimum conditions for the microorganisms.

After about eight weeks, the temperature drops to 30 -40°C and the compost heap enters the **transformation phase**. The heap becomes populated with various invertebrates, such as mites, millipedes, beetles, earwigs, earthworms, slugs, and snails. As the material is a nutrient source to them, they continue the degradation process and cut down the coarse compost material into a crumbly soil-like substance. Though the material looks like compost, it is not yet stabilised and certain chemical substances (e.g. nitrite) may inhibit plant growth if applied directly to the flora.

The compost heap enters the **synthesis or maturing phase** when the insects abandon the compost. Ongoing chemical and biological processes transform nitrite to nitrate and slowly link the short-chained humic substances into stable and nutrient-rich humus. Depending on the local conditions (e.g. temperature and input material), the compost is mature after 3-6 months.

Main factors influencing the composting process are listed and explained below:

### Carbon and nitrogen content

These elements are essential for growth and cell division of the microorganisms. Microorganisms can only degrade the organic carbon present in the waste if they have enough nitrogen for growth. If nitrogen is lacking, or if the C:N ratio is high, the composting process is inhibited. The ideal carbon:nitrogen ratio to start composting ranges between 25:1 and 40:1 (i.e. 25-40 parts carbon to 1 part nitrogen in terms of dry weight). This allows rapid and efficient degradation of the organic material. Since carbon availability also plays a decisive role, the organic carbon of fine sawdust is more rapidly available than that of coarsely shredded wood or coconut shells.

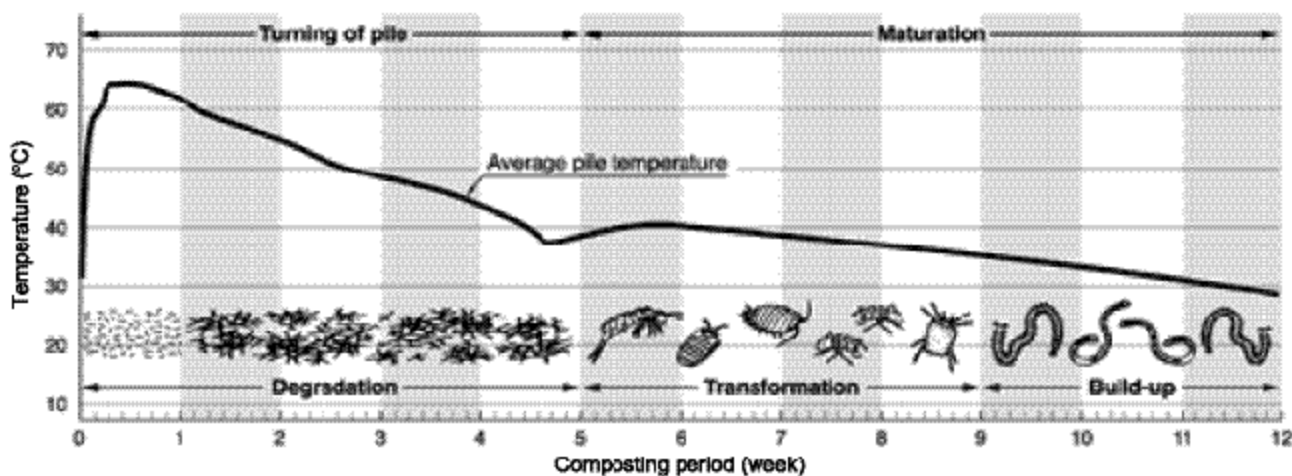

Graph 7.1: Temperature and processes during composting

As the determination of C:N ratio requires costly laboratory analysis, practitioners have developed a standard procedure for determining mixing ratios. In practice, the ideal combination of different feedstock types requires practical tests and experience. Some organic input material is high in carbon, some in nitrogen. Examples of “green” and “brown” waste are given in Table 7.1 of Task 7. It is generally advisable to start a mixing ratio with one part “green” and one part “brown” waste. Depending on process performance, adjustments may have to be made for every new compost pile.

### Oxygen

Microorganisms can either degrade organic waste aerobically (with oxygen) or anaerobically (without oxygen). Composting is an aerobic degradation process which is faster than anaerobic digestion. To allow aerobic microorganisms to be active in the pile, sufficient oxygen should be maintained in the system. Air can be introduced into the pile by turning the material frequently or by allowing air to penetrate the pile through active or passive ventilation. In active ventilation, air is blown or drawn through the compost pile. Passive ventilation takes advantage of natural air diffusion through the pile, which can be enhanced by ventilation structures such as perforated pipes, triangular bamboo racks or openings in the walls of compost bins. If the oxygen supply in the pile is limited, proliferation of anaerobic microorganisms is enhanced. These species should be avoided during the composting process, as they produce malodorous gases such as hydrogen sulphide and ammonia.

### Moisture

As microorganisms can only take up nutrients for their growth from the liquid phase of the material, it is important that an adequate moisture content is maintained in the pile. The ideal moisture content throughout the pile should range between 40 and 60 percent by weight. Higher moisture levels slow down decomposition and promote anaerobic degradation, as air spaces in the pile are filled with water and can no longer be supplied by oxygen. A moisture content below 40 percent causes the microorganisms to slow down their activity for lack of nutrient supply. Moisture can be controlled best if the compost piles are covered by a roof to protect them from direct sun and excessive rain. If composting is conducted outdoors, the piles should be designed as steep as possible and covered by canvas, composting fleece or gunny bags. The cover protects the pile from both excessive evaporation and excessive water infiltration during rainfall. An optimum moisture level is reached if the composting material feels damp to the touch; i.e. if a few drops of liquid are released while squeezing a handful of material (see Figure 7.4 in the main part).

### Size and Structure

The surface area of the organic material exposed to microorganisms is another factor determining the composting rate. Shredded and chipped waste material, or otherwise reduced in size, is degraded more rapidly - a fact especially important when processing wood and other materials that degrade slowly. Particles which are too fine should be avoided as they reduce permeability and so restrict air circulation in the compost pile.

### Temperature

In aerobic decomposition, heat is generated as a result of microbial activity in the pile. Different groups of organisms become active with increasing temperature in the pile. With adequate levels of oxygen, moisture, carbon and nitrogen, compost piles can heat up to temperatures in excess of 65°C. However, higher temperatures begin to limit microbial activity. Temperatures over 70°C are lethal to most soil microorganisms and stop the composting process. Although composting will also continue at lower temperatures, high temperatures should be maintained to accelerate composting and destroy weed seeds, insect larvae and potential plant or human pathogens likely to be present in the waste material.

## Annex 8: Compost Quality Standards

Comparison of compost quality standards for compost used in agriculture from Switzerland, India and Great Britain (2006)

| Criteria                                     | Switzerland<br>Association of Swiss<br>Compost Plants (ASCP) | India<br>Indian Institute for Soil<br>Science<br>(04 Task Force) | Great Britain<br>PAS 100 (BSI)<br>and<br>Apex-Standard* |
|--|--|--|---|
| <b>Indicators for Maturity/ Stability</b>    |  |  |   |
| pH   | < 8.2  | 6.5 – 7.5  | 7.5 - 8.5*  |
| Organic Matter                               | < 50%  | > 16% C <sub>org</sub>   | 30 - 40%*   |
| NO <sub>3</sub> -N/ NH <sub>4</sub> -N ratio | > 2  | —  |   |
| C/N ratio                                    | > 21:1   | 20:1   | 15:1 - 20:1*  |
| Dry weight                                   | > 50%  | 75 – 85%   | 65 - 55%*   |
| Decomposition                                | feedstock unrecognisable, except<br>for wood                 | dark brown<br>no odour   | —   |
| Plant compatibility                          | planting tests (cress, salad,<br>beans, ...)                 |  | 20% below control                                       |
| Respiratory Test                             | —  | < 15 mg CO <sub>2</sub> -C per 100 g TOC/<br>day                 | < 16 mg CO <sub>2</sub> /g organic matter/<br>day       |
| <b>Indicators for Nutrients</b>              |  |  |   |
| Phosphorous (P <sub>2</sub> O <sub>5</sub> ) | > 0.7%   | 0.5 – 0.8%   | 25 - 40 mg/l*   |
| Potassium (K <sub>2</sub> O)                 | -  | 1-2%   | 0.5 - 0.7%*   |
| Total Nitrogen                               | > 1% DS**  | > 0.8% DS  | 0.7 - 1.0%*   |
| NO <sub>3</sub> -N                           | > 40 mg/kg WS  | —  | 15 - 120 mg/l*  |
| NH <sub>4</sub> -N                           | > 300 mg/kg WS   | —  | 1 - 5 mg/l*   |
| <b>Indicators for Pollution</b>              |  |  |   |
| Impurities                                   | < 1%, no visible plastic, glass or<br>metal                  | < 1% inert material and foreign<br>matter                        | < 0.5% of total air-dried sample<br>by mass             |
| Cadmium (mg/kg DS)                           | 1  | 5  | 1.5   |
| Chromium (mg/kg DS)                          | 100  | 50   | 100   |
| Copper (mg/kg DS)                            | 100  | 300  | 200   |
| Lead (mg/kg DS)                              | 120  | 300  | 200   |
| Nickel (mg/kg DS)                            | 30   | 50   | 50  |
| Mercury (mg/kg DS)                           | 1  | 2.5  | 1   |
| Zinc (mg/kg DS)                              | 400  | 500  | 400   |

\* Apex is a voluntary standard, launched by three of the UK's biggest waste management firms.

\*\* DS = dry solids

## Annex 9: Templates for Compost Monitoring

### Template 1: Monitoring Table for Single Windrow

|                   |                    |                         |           |              |
|-------------------|--------------------|-------------------------|-----------|--------------|
| <b>Pile No:</b>   |                    | <b>Waste type</b>       |           |              |
| <b>Start Day:</b> |                    | <b>Original Volume</b>  |           |              |
|                   |                    |                         |           |              |
| <b>Day</b>        | <b>Temperature</b> | <b>Moisture (A,B,C)</b> | <b>pH</b> | <b>Notes</b> |
| 1                 |                    |                         |           |              |
| 2                 |                    |                         |           |              |
| 3                 |                    |                         |           |              |
| 4                 |                    |                         |           |              |
| 5                 |                    |                         |           |              |
| 6                 |                    |                         |           |              |
| 7                 |                    |                         |           |              |
| 8                 |                    |                         |           |              |
| 9                 |                    |                         |           |              |
| 10                |                    |                         |           |              |
| 11                |                    |                         |           |              |
| 12                |                    |                         |           |              |
| 13                |                    |                         |           |              |
| 14                |                    |                         |           |              |
| 15                |                    |                         |           |              |
| 16                |                    |                         |           |              |
| 17                |                    |                         |           |              |
| 18                |                    |                         |           |              |
| 19                |                    |                         |           |              |
| 20                |                    |                         |           |              |
| 21                |                    |                         |           |              |
| 22                |                    |                         |           |              |
| 23                |                    |                         |           |              |
| 24                |                    |                         |           |              |
| 25                |                    |                         |           |              |
| 26                |                    |                         |           |              |
| 27                |                    |                         |           |              |
| 28                |                    |                         |           |              |
| 29                |                    |                         |           |              |
| 30                |                    |                         |           |              |
| 31                |                    |                         |           |              |
| 32                |                    |                         |           |              |
| 33                |                    |                         |           |              |
| 34                |                    |                         |           |              |
| 35                |                    |                         |           |              |
| 36                |                    |                         |           |              |
| 37                |                    |                         |           |              |
| 38                |                    |                         |           |              |
| 39                |                    |                         |           |              |
| 40                |                    |                         |           |              |
| 41                |                    |                         |           |              |
| 42                |                    |                         |           |              |
| <b>End Date:</b>  |                    | <b>End Volume:</b>      |           |              |

A: moisture is right (60%); B: too dry, C: too wet (see Task 7, Operation)



Template 3

Temperature Graph for Composting

Pile No:

Start Day:

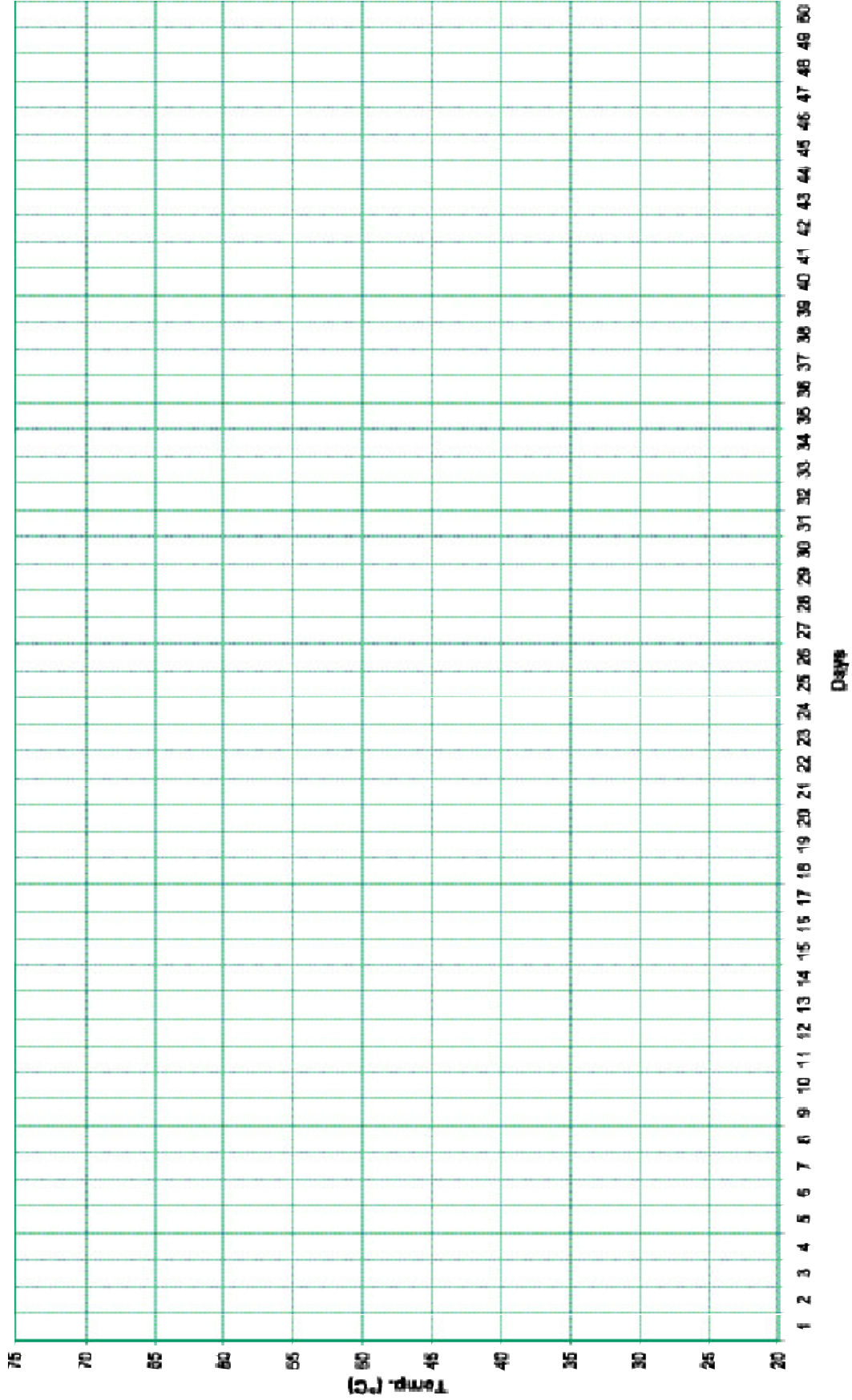

Mark the days, when the compost is turned with a different sign



### Template 4: Final Quality Control Sheet for Compost

|                               |              |              |               |
|-------------------------------|--------------|--------------|---------------|
| Compost Sample                |              | Pile No:     |               |
| Date of Sampling              |              |              |               |
| Laboratory                    |              |              |               |
| Date of Analysis              |              |              |               |
| <b>Further Information:</b>   |              |              |               |
|                               | <b>Value</b> | <b>Unit*</b> | <b>Method</b> |
| Moisture                      |              | %            |               |
| Organic Matter                |              | %            |               |
| NO <sub>3</sub> -N            |              |              |               |
| NH <sub>4</sub> -N            |              |              |               |
| Total N                       |              |              |               |
| Total C                       |              |              |               |
| C/N Ratio                     |              |              |               |
| P <sub>2</sub> O <sub>5</sub> |              |              |               |
| K <sub>2</sub> O              |              |              |               |
| Mg                            |              |              |               |
| <b>Heavy Metals</b>           |              |              |               |
| Cadmium                       |              |              |               |
| Chromium                      |              |              |               |
| Copper                        |              |              |               |
| Lead                          |              |              |               |
| Mercury                       |              |              |               |
| Nickel                        |              |              |               |
| Zinc                          |              |              |               |
|                               |              |              |               |
|                               |              |              |               |
|                               |              |              |               |

\* the unit of the measurement depends on the standard analysis requirements of the respective country.

\_\_\_\_\_  
Date, Signature

## Annex 10: Preliminary Compost Application Guide

Compost is most commonly used as soil conditioner or fertiliser. Though compost cannot compete with chemical fertilisers as regards nutrient content, it has several significant advantages if combined with other fertilisers. Compost can be regarded as a long term source of nutrients. Agricultural studies showed that within 4-5 years compost releases:

- 40% of its nitrogen
- 100% of its phosphorus
- 100% of its potassium
- 100% of its magnesium

Graph 10.1 shows the differences of nutrient release between artificial fertilisers and compost. It becomes clear that compost is a long term source of nutrients and can only partly substitute artificial fertilisers over the year.

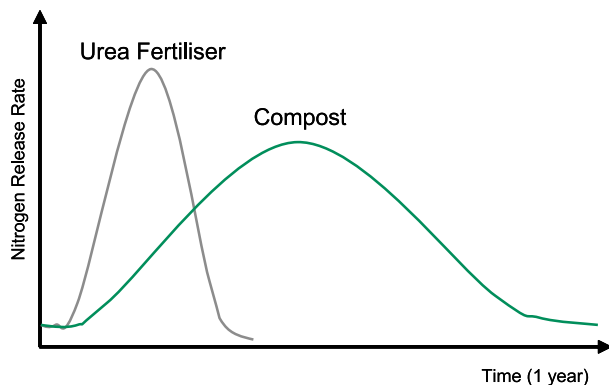

Graph 10.1: Artificial fertiliser and compost show different nutrient release patterns

If applied correctly at the right dose, compost

- improves the soil structure due to the higher organic matter content
- improves the water retention
- improves the soil biology and plant resistance to diseases
- buffers “acidic” soils due to the mineral combination
- is foremost a valuable phosphorous source.

The time of application and amount vary according to soil type, crop and purpose. However, it can generally be said that compost is applied most effectively before planting to improve soil structure and allow a slow release of nutrients.

The amount of compost applied is dependent on the nutrient demand of the respective plants, the general nutrient balance of the field and soil characteristic of the area. Application is based on nutrient dose and not on total amount of compost. Hence, the nutrient content of the compost should be known to ensure the appropriate application rate for compost.

**The following example illustrates the correlation:** One ton of compost with 1.2% nitrogen content contains 12 kg nitrogen per ton of compost. Considering the aforementioned release rate of 40% over four years, only 4.8 kg nitrogen are available to plants. To cover a nitrogen demand of 200 kg nitrogen per hectare, a farmer needs to apply approx. 41 tons of compost per hectare.

With conventional compost containing 1% nitrogen, 0.3% phosphorus and 0.9% potassium, the following application is recommended. However, it is important to consult national rules and recommendations as soil type and climate influence the nutrient release.

Table 10.1: Recommended application rates for composts

| Crop/ Culture                     | Dose     | Area<br>1 hectare = 10 000 m <sup>2</sup><br>1 acre = 4047 m <sup>2</sup> | Time and type of application                                |
|-----------------------------------|----------|---|---|
| <b>Agriculture/Horticulture</b>   |          |   |   |
| Cereals                           | 30 tons  | hectare   | Every 2-3 years during land preparation for new crop season |
| Vegetables                        | 20 tons  | hectare   | Every 2-3 years during land preparation for new crop season |
| Greenhouse (Vegetables & Flowers) | 100 kg   | 100 m <sup>2</sup>  | Very mature compost as cover before planting                |
| <b>Landscaping/Forestry</b>       |          |   |   |
| Forestry                          | 3 – 5 kg | Per tree  | Before planting   |
| Fruit tree                        | 100 tons | hectare   | Every 3 years   |
| Lawn                              | 100 kg   | 100 m <sup>2</sup>  | Final land preparation or top dressing                      |

Note that since enriched compost contains much higher nutrient contents, lower compost quantities are required.

## Annex 11: Definitions and Glossary

This document adheres to the definitions of terms as described in the Indian Solid Waste Management rules 2000. Additional terminology is based on the following publications which are also available online:

- International Environmental Technology Centre (1996): International Source Book on Environmentally Sound Technologies for Municipal Solid Waste Management. pp. 421-427 <http://www.unep.or.jp/ietc/estdir/pub/msw/index.asp>
- The Global Development Research Center - Urban Environmental Management

|                              |  |
|------------------------------|--|
| <i>Anaerobic digestion</i>   | refers to the process by which biodegradable waste components are biologically decomposed under controlled conditions by microorganisms in the absence of oxygen   |
| <i>Animal manure</i>         | refers to the excreta of animals together with whatever bedding material is needed to follow good husbandry practices  |
| <i>Backyard composting</i>   | refers to the diversion of biodegradable waste such as food scraps and yard trimmings from the municipal waste stream through on-site controlled decomposition of organic matter by microorganisms (mainly bacteria and fungi)   |
| <i>Biodegradable waste</i>   | refers to waste which can be naturally degraded - aerobically or anaerobically. (i.e. vegetables, wood, grass, leaves, manure, food processing waste)  |
| <i>Biogas</i>                | a mixture of gases, predominantly methane (CH <sub>4</sub> ) and carbon dioxide (CO <sub>2</sub> ), produced by <i>anaerobic digestion</i>   |
| <i>Bio-methanation</i>       | see <i>anaerobic digestion</i>   |
| <i>Brown waste</i>           | refers to biodegradable waste types which are high in carbon. Typical examples are wood chippings, saw dust, twigs and leaves  |
| <i>Communal collection</i>   | a system of collection in which individuals bring their waste directly to a central point from which it is collected.  |
| <i>Compost</i>               | is a stabilised organic product produced by a controlled biological decomposition process inasmuch as the product may be handled, stored and applied to land according to a set of directions for use  |
| <i>Composting</i>            | refers to the process by which biodegradable waste components are biologically decomposed under controlled conditions by microorganisms (mainly bacteria and fungi) under aerobic conditions   |
| <i>Composting facility</i>   | refers to an offsite facility (i.e. not at the point of generation of the waste) where the biodegradable waste components are biologically decomposed under controlled conditions by microorganisms (mainly bacteria and fungi)  |
| <i>Curing</i>                | allowing partially composted materials to sit in a pile for a specified period of time as part of the maturing process in composting   |
| <i>Dry waste</i>             | a term used in India for all municipal solid waste which is not biodegradable  |
| <i>Feedstock</i>             | refers to any biologically degradable organic material used as an ingredient in the production of compost  |
| <i>Garden waste</i>          | leaves, grass clippings, yard trimmings and other organic garden waste. Sometimes also referred to as yard waste   |
| <i>Green waste</i>           | refers to biodegradable waste types which are high in nitrogen. (i.e. cow or chicken manure, vegetable waste, grass cuttings)  |
| <i>Informal sector</i>       | the part of the economy characterised by the labour of self-employed individuals, often waste pickers, waste collectors and traders. This private sector is usually small-scale, labour-intensive, largely unregulated, with unregistered manufacturing or service provision |
| <i>Inorganic waste</i>       | refers to waste composed of material other than plant or animal matter, such as sand, dust, glass, metals.   |
| <i>Inert waste</i>           | refers to waste which does not react with other components or the environment.   |
| <i>Itinerant waste buyer</i> | a person who buys (or barter) reusable and recyclable materials from households and businesses or on the street  |
| <i>Leachate</i>              | liquid (which may be partly produced by decomposition of organic matter) which has seeped through a landfill or a compost pile, accumulating a load of microorganisms and other possibly harmful dissolved or suspended materials  |

|  |   |
|--|---|
| <i>Market waste</i>                        | primarily biodegradable waste, such as leaves, skins, and unsold food discarded at or near food markets   |
| <i>Municipal Authority</i>                 | refers to a Municipal Corporation, Municipality, Nagar Palika, Nagar Nalim, Nagar Panchayat, Municipal Council, or any other local body which has been entrusted with the responsibility for providing solid waste management services  |
| <i>Municipal solid waste (MSW)</i>         | all solid waste generated in a municipal area apart from industrial and agricultural waste. In also generally excludes hazardous waste, construction and demolition debris, and other special wastes, unless they enter the municipal waste stream.<br><br>Sometimes defined to mean all solid waste a city authority accepts to manage in some way   |
| <i>Municipal solid waste stream</i>        | refers to the flow of MSW to be managed, starting with generation and collection and ending with disposal of any residues to land   |
| <i>Non-governmental organisation (NGO)</i> | the World Bank defines NGOs as “private organisations pursuing activities to relieve suffering, promote the interests of the poor, protect the environment, provide basic social services, or undertake community development. In wider usage, the term NGO can be applied to any non-profit and non-government organisation. NGOs are typically value-based organisations depending, in whole or in part, on charitable donations and voluntary services. Although the NGO sector has become increasingly professionalised over the last two decades, principles of altruism and voluntarism remain key defining characteristics |
| <i>Nursery</i>                             | is a business which grows seedlings for ornamental plants and trees. They are often located at the outskirts of cities along the main roads. Main customers are private house owners with gardens but also municipal authorities buying plants for parks and green road dividers.   |
| <i>Organic waste</i>                       | has two meanings.<br><br>Firstly, the term is used to refer to easily biodegradable waste material of animal or plant origin, such as food and yard waste. Wood and paper are sometimes included although they are not easily biodegradable.<br><br>Secondly, synthetic products from raw oil like plastics are often classed as organic materials (chemical literature) but they are not biodegradable.  |
| <i>Pathogen</i>                            | refers to an organism capable of causing disease (in sufficient numbers)  |
| <i>Putrescible</i>                         | usually used to refer to biodegradable material such as food waste and other organic wastes rapidly decaying  |
| <i>Source segregation</i>                  | refers to the practice of avoiding the mixing certain types of waste by discarding them into different containers. For example, biodegradable waste could be discarded into one container (to provide a good feedstock for composting) and other wastes could be put into a different container, to be collected and treated differently. This is done in such a way that the materials are never mixed. At source segregation needs to be done at household level and needs significant efforts in awareness raising and education.  |
| <i>Separation</i>                          | refers to a separation of already mixed waste into different fractions (e.g. biodegradable waste, plastic, glass, etc.). Waste separation is a very time consuming and tedious job as manual labour can hardly be avoided.  |
| <i>Vermicomposting</i>                     | is a process where biodegradable waste components are biologically decomposed and fed to earthworms to produce vermicompost, which is the castings of the earthworms  |
| <i>Waste collection</i>                    | refers to the process of picking up waste from households, businesses or a collection point, loading it into a vehicle, and transporting it to a processing, transfer or disposal site  |
| <i>Waste pickers</i>                       | a person who earns an income by picking recyclable materials from the waste stream, usually either from the street, from containers or from waste disposal sites.   |
| <i>Wet waste</i>                           | a term used in India for organic waste, especially biodegradable food waste, cooked or uncooked   |
| <i>Windrow</i>                             | refers to a long low triangular line of material (i.e. hay or biodegradable waste) designed to achieve the best conditions for curing or drying   |
| <i>Yard waste</i>                          | see <i>garden waste</i>   |

## Annex 12: Authors and Reviewers

### Iftekhhar Enayetullah

a civil engineer-urban planner, is Co-founder and Director of Waste Concern. He has been working and also conducting research in the fields of solid waste management, industrial pollution control, environmental management and clean energy for more than fifteen years. He is actively involved in planning, designing and implementation of several decentralised waste management projects in Bangladesh as well as in Sri Lanka and Vietnam. Recently, he is also involved in designing and implementation of Clean Development Mechanism (CDM) based waste management and energy projects.

### Silke Rothenberger

is an environmental engineer with a background in economy working in the Department of Water and Sanitation in Developing Countries (Sandec) of the Swiss Federal Institute of Aquatic Science and Technology (Eawag). She has experience in the fields of rural water supply, urban sanitation and solid waste management in Africa and Asia and the Middle East. Her main research interest is the interrelation between technical and socio-economic systems focusing on integrated approaches and resource recovery.

### A. H. Md. Maqsood Sinha

an architect-urban planner is Co-founder and Executive Director of Waste Concern. He has been working and conducting research in the fields of solid waste management, sustainable development, clean energy and municipal services planning for more than eighteen years. He is involved in planning, designing and implementation of several waste management and recycling projects in Bangladesh as well as in Sri Lanka and Vietnam. Recently, he is also involved in designing and implementation of Clean Development Mechanism (CDM) based waste management and energy projects.

### Chris Zurbrügg

is the Director of the Department of Water and Sanitation in Developing Countries at the Swiss Federal Institute of Aquatic Science and Technology. His research interests focus on the urban environment in cities of the developing world in particular on the challenges with regard to solid waste management, environmental sanitation and water supply. In addition to the technical issues of this domain his interest have comprised the economic, institutional and social issue surrounding sustainable solutions for improving health and wellbeing of the urban population by improved environmental services and infrastructure. His research experience is based on projects in a multitude of low and middle income countries in the Asian, African and Latin American regions.

**The authors would like to give special thanks to the experts who have contributed their expertise and time to review and evaluate this handbook. Their comments and contributions were highly appreciated.**

### Adrian Coad

has spent most of his professional life in solid waste, much of it as a consultant working in Asia, Africa and the Middle East. He also enjoys teaching and writing, and has edited or written a few publications, including workshop reports and publications on private sector participation and healthcare waste management. He is very much aware of the importance of the human element in all attempts to improve waste management, and is looking for answers to challenges in the fields of motivation and supervision.

### Daniel Hoornweg

is a senior environmental engineer working in the Urban Development Division of the World Bank and coordinator for the East Asia and Pacific Region. He is the co-author of two World Bank publications on composting.

and

### Sandra Spies

is coordinating the programme "*Partnerships in Recycling Management*" of the German Technical Cooperation. She works in the context of pro-poor solid waste management and informal sector activities and is supporting several GTZ waste management projects. Most of her overseas experience took place in Latin American countries.

Special thanks to Sylvie Peter (Sandec) for her support and linguistic revision of this book.  
Layout and graphic design by Yvonne Lehnhard, Lydia Zweifel and Md. Tarek Haider.

This manual has been published jointly by Waste Concern and Eawag / Sandec with support from Sustainable Environment Management Programme (SEMP), of the Ministry of Environment and Forest (MoEF), Government of Bangladesh (GoB), United Nations Development Programme (UNDP) and The Swiss Agency for Development and Cooperation (SDC).