

Menstruation hygiene management for schoolgirls in low-income countries

This fact sheet outlines the problems experienced by menstruating schoolgirls in low-income countries. Although its focus is predominantly sub-Saharan Africa, many of the issues raised are relevant to girls in most low-income countries, although there may be differences in popular practice and beliefs. The fact sheet also evaluates simple solutions to these problems including the use of low-cost sanitary pads, and suggests ways in which menstruation hygiene management (MHM) can be included in water, sanitation and hygiene (WASH) programmes. It considers how menstrual practices are affected by cultural beliefs and the lack of education both at home and at school.



Problems faced by menstruating schoolgirls

Schoolgirls from low- middle-income families often struggle to manage their monthly periods. They are constrained by practical, social, economic and cultural factors. The main problems faced are:

- the expense of commercial sanitary pads;
- the lack of water for bathing and washing of menstrual materials;
- dirty latrines – the hygiene hazards and unpleasantness;
- the lack of hygienic anal cleansing materials;
- unsuitable places to dry menstrual materials;
- the lack of access to pain relief (analgesic) drugs;
- inadequate waste disposal facilities;
- the lack of privacy for changing menstrual materials;
- 'leakage' from poor-quality protection materials;
- the lack of resources for washing such as soap and basins;
- limited education about the facts of menstruation;
- limited access to counselling and guidance;
- fear caused by cultural myths;
- embarrassment and low self-esteem; and
- the unsupportive attitudes of some men.

Absenteeism

Absenteeism, where girls stay at home rather than attending school, sometimes occurs when schoolgirls are menstruating. There is debate about the reasons for menstrual-related absenteeism. There are three main arguments:

- a) Schoolgirls do not have adequate sanitary protection materials** (i.e. pads). They are embarrassed about the potential 'leaking' of blood if less protective materials are used (Scott et al., 2009).
- b) Dysmenorrhoea** (or period pain) causes schoolgirls to feel unwell. If there is nowhere to rest in school or if analgesic drugs are not readily available, girls prefer to remain alone at home (Crofts, 2010).
- c) Inadequate water supply and sanitation facilities** deter schoolgirls if they cannot wash or change in privacy (WaterAid, 2009).

MHM

Menstruation Hygiene Management (MHM) focuses on practical strategies for coping with monthly periods. MHM refers to ways women keep clean and healthy during menstruation and how they acquire, use and dispose of blood-absorbing materials.

In reality, menstrual-related absenteeism is likely to be a combination of all the factors above. Schoolgirls may also miss school for other, non-menstrual related reasons, such as caring for sick relatives, helping with the harvest or being ill with diseases such as malaria or diarrhoea.

When a schoolgirl misses a significant number of lessons her academic performance suffers which may mean she drops out of education altogether. Girls dropping out of school early is known to affect the health, size and educational well-being of the next generation.

Other sexual maturation-related factors which influence school drop out are early marriages, child bearing and girls being targeted for sexual abuse by teachers or fellow students.

Cultural and religious restrictions

As a taboo topic in many cultures, the process and management of menstruation is often shrouded in mystery. In schools, there is usually a lack of physiological education. This is often attributed to predominantly male science teachers feeling uncomfortable about teaching such a subject, especially if they have not received formal training in how to do so. At home, advice (traditionally given by aunts and grandmothers) is often insufficient. The latter can be partly attributed to the dispersion of families from their places of origin, especially with increased urban migration during the last two decades. Older women often considered 'wise' are also often illiterate or uneducated themselves, and may recount and reinforce myths that are biologically incorrect.

Cultural restrictions and discriminatory gender roles exacerbate women's difficulties during menstruation. The extent to which schoolgirls are constrained and restricted is determined by tribal and family ideologies. Nowadays, it

is common for traditional rituals to be performed only at menarche (a girl's first period), although in some rural areas women must refrain from certain activities every month.

There is a blurring of the boundaries between cultural ethics and religious beliefs regarding menstrual hygiene, such that communities claiming to be of the same religion may carry out different MHM practices due to geographical and socio-economic variance.

For example, some devout muslim women may be restricted from any form of community activity during their periods and avoid contact with men because bodily excretions

such as blood deem them 'impure'. 'Purity' can be regained by full body washing ("ghusl") when bleeding ceases. However, other islamic communities may take a more liberal approach, allowing greater freedom of movement during menstruation and adapting rituals to meet environmental conditions (e.g. adapting bathing requirements if water is scarce). Consequently no two communities have exactly the same MHM practices or attitudes towards blood management, meaning WASH practitioners must approach MHM on a case-by-case basis. Table 1 outlines some examples of myths that exist among the Buganda tribe in Uganda.



Figure 1. Women may be restricted from any form of community activity during their periods

Table 1. Examples of cultural myths about menstruation from southern Uganda

Restrictions on menstruating women	Associated beliefs
<ul style="list-style-type: none"> Confinement to a room or a separate menstruation hut to avoid interaction with men 	<ul style="list-style-type: none"> A menstruating woman is 'unclean'
<ul style="list-style-type: none"> Prohibited from cooking, fetching water, sweeping or doing any housework 	<ul style="list-style-type: none"> Objects, especially food and drink, that are touched become contaminated and cause the user/consumer to be cursed
<ul style="list-style-type: none"> Not allowed to cross roads or walk around freely 	<ul style="list-style-type: none"> Crossing a road will increase a woman's menstrual flow
<ul style="list-style-type: none"> Forbidden from walking through gardens where certain food is growing (e.g. pumpkins or groundnuts) 	<ul style="list-style-type: none"> The produce will rot or yield a poor harvest
<ul style="list-style-type: none"> Forbidden from entering a kraal (cattle pen) containing pregnant cows 	<ul style="list-style-type: none"> The cows will miscarry
<ul style="list-style-type: none"> Prohibited from using open wells 	<ul style="list-style-type: none"> The well may dry up or become filled with blood
<ul style="list-style-type: none"> Women must hide menstrual cloths and protection products 	<ul style="list-style-type: none"> Those who see such cloths, especially if blood-stained, will be cursed. Women whose protection materials are sniffed by dogs become infertile.

Basic facts about menstruation

- Menstruation is the monthly shedding of the uterus lining in females of reproductive age.
- Periods occur, on average, every 28 days.
- Bleeding during periods usually lasts for 5–7 days, but can be more or less than this.
- The average blood loss during menstruation is 35 millilitres.
- Excessive blood loss of 80ml or more is known as *menorrhagia*.
- It is common for women to experience abdominal cramps each month.
- Severe menstrual pain is called *dysmenorrhoea*.
- 1 in 10 women experience dysmenorrhoea, especially those under the age of 30.
- *Menarche* is the name given to a young woman's first period and typically occurs around age 12.
- *Menopause*, experienced by women usually aged 45 – 55, is when menstruation ceases.

Practical considerations for MHM

Four ways in which practitioners can enable schoolgirls to overcome some of the problems mentioned above are by:

1. promoting low-cost sanitary pads;
2. designing female-friendly sanitation facilities;
3. increasing access to pain-relief medication; and by
4. providing education and counselling.

These will be considered in turn, with particular emphasis on low-cost sanitary pads.

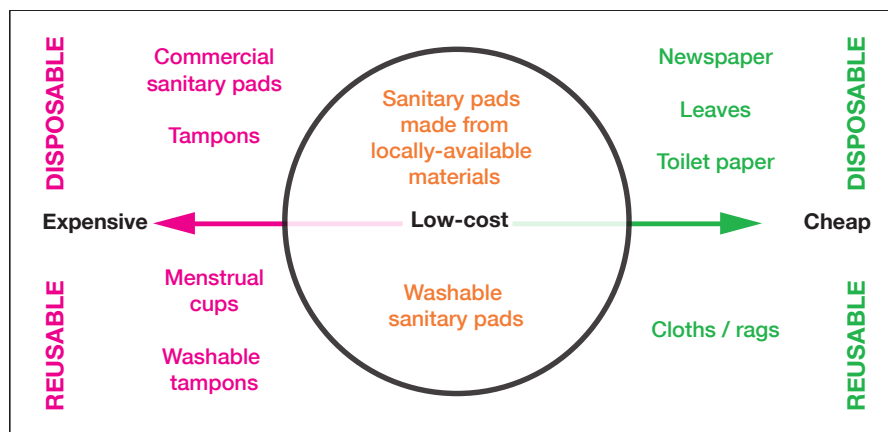

Figure 2. Low-cost pads bridge an economic gap

1. Low-cost sanitary pads

The need

Commercially-produced disposable sanitary pads, are too expensive for most African schoolgirls. A packet of 10 pads costs on average US\$1.35, which is significantly more than the daily income of many working parents.

The commonly-used alternative menstrual protection materials are pieces of rag that may be dirty, and sometimes sourced from rubbish pits. These are unhygienic if not washed thoroughly before and after use. They can cause chafing and often leak due to poor absorbency. Low-cost sanitary pads are designed to bridge the gap between these materials, as shown in Figure 2.

The options

There are two types of sanitary pads: washable and disposable. Examples of each type are outlined as shown, namely Afripads and Makapads. Table 2 further outlines the work of other low-cost sanitary pad producers currently manufacturing in sub-Saharan Africa. An alternative, even cheaper solution is to teach girls how to sew their own pads from spare material, as promoted by the Forum for African Women Educationalists (FAWE). Homemade pads come in all shapes and sizes but can be bulky owing to the amount of material required to make them sufficiently absorbent.

Environmental considerations

Locally-produced low-cost pads are more environmentally-friendly than commercially-produced pads because they contain fewer chemicals (such as polyacrylate superabsorbent gels).

The two types of low-cost pads have further advantages:

Reusable, sewn pads

- The simple manufacturing process does not use electricity or fossil fuels.
- Minimal solid waste disposal facilities are required.

Disposable pads

- The absorbent natural materials are biodegradable.
- There is minimal fuel consumption from transport because materials are locally-available.

Assumption about underwear

When referring to sanitary pads and protection materials it is assumed that schoolgirls have access to underwear. However, in extremely poor settings, very rural communities or refugee/IDP camps, girls may not be used to wearing panties. It is therefore vital that WASH practitioners research underwear usage before encouraging sanitary pad use.

2. Female-friendly sanitation facilities

To make school sanitation facilities more user-friendly for menstruating girls the following points should be taken into consideration (Figure 3):

- Build all-in-one latrines and bathing facilities so that girls do not have to walk between blocks.
- Provide a mixture of cubicles within a walled all-in-one unit:
 - latrine-only cubicles for urination and defecation;
 - bathing-only cubicles which have a sloping floor with drainage holes for wastewater;
 - large cubicles containing both a squatting slab for defecation/ urination and a washing area.
- Construct high walls made from solid materials without holes.
- Ensure all cubicle have doors with locks for privacy.
- Provide piped water or a storage tank inside the block and drainage channels/pipes for wastewater.
- Consider using an incinerator inside the block (or a chute to an incinerator located outside the block) that has a non-return trapdoor mechanism.
- Design the cubicles to be light and well ventilated (although any window must be situated well-above head height).
- Hang mirrors so girls can check their appearance (to encourage self-confidence).

- Establish cleaning rotas, maintenance plans and ways to ensure they are observed.
- Ensure resources are provided to encourage good hygiene practices (e.g. soap, toilet paper, containers and basins to carry water to the cubicles).
- Construct latrine pits with extra capacity to take account of the solid waste materials that will be deposited in them.

Additionally, for schools with boarding students, sanitation blocks should also include:

- a room for washing menstrual cloths; and
- drying lines or pegs ideally exposed to sunlight, situated above head height but below the height of the walls.

3. Pain-relief medication

For a relatively small cost, the availability of painkillers would significantly improve the well-being of many schoolgirls each month.

Few NGOs are currently pursuing this intervention largely because it is not something that can be solved with a one-off action. More research is required to ascertain:

- the most effective distribution strategy (e.g. through health centres, senior women teachers, local stores);
- sustainable funding mechanisms for subsidizing tablets; and
- the most suitable tablets for MHM in low-income countries.

Question...

Are tampons and menstrual cups feasible options in sub-Saharan Africa?

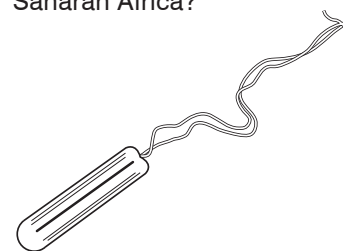

Answer...

Not at present, for cultural and practical reasons:

- Culturally, insertion products may be unacceptable. Some myths suggest that they interfere with female reproductive organs and their use causes a girl to lose her virginity.
- Practically, poor hygiene can result in urinary tract and vaginal infections. The insertion of unsterile products or unsterile insertion methods poses even greater health risks, especially where access to medical treatment is limited.
- Additionally, tampons are rare and considered to be a luxury product used by 'modern' women mostly in urban areas. There is a link between scarcity, demand and non-local manufacturing which affect the price of tampons and menstrual cups. Their high prices make them unaffordable to women from mid- to low-income families.

Table 2. Examples of other low-cost sanitary pad producers in Sub-Saharan Africa

Product / Programme	Organisation	Washable / Disposable	Raw materials	Country	Website
SHE 28 Campaign	Sustainable Health Enterprises (SHE)	Disposable	Banana stem fibres	Kigali, Rwanda	www.sheinnovates.com
Reusable sanitary kits	Huru International	Washable	Raised cotton and waterproof material	Kabondo, Kenya	www.huruinternational.org
Locally-produced sanitary pads	Forum for African Women Educationalists (FAWE)	Washable	Old clothes and sheets (girls are taught to sew pads from old sheeting)	Lango, Uganda	www.fawe.org

Afripads

Product:

Reusable, washable pads made from raised cotton and waterproof lining material. Each Afripads menstrual kit contains a mixture of base pads, wide liners and straight liners, an instruction booklet and a waterproof bag for transporting dirty pads.



Advantages

- Soft and comfortable to wear
- Manufacturing workshops can be easily set up in rural locations
- A tenth of the price of commercial pads if used for one year

Disadvantages

- Not as absorbent as commercial pads
- Relies on imports of material from China
- Users need to have access to water and soap for washing

Location: Masaka, Uganda

Website: www.afripads.com

Makapads

Product:

Disposable sanitary pads made from sheets of softened paper and papyrus sealed between layers of thin polythene. After the papyrus is cut, the green cover is peeled away and the white stem is what is used in the making of the pads.



Advantages

- Mostly uses locally-available materials
- Absorbent layers are biodegradable
- A third of the price of commercial pads

Disadvantages

- Complex manufacturing process
- Requires electricity for heat sealing and sterilization
- Too thin and narrow for schoolgirls with heavy flow

Location: Technology for Tomorrow, Makerere University, Kampala, Uganda

How to make a basic cloth sanitary pad

1. Cut out the 3 shapes (shown below left) from a soft and breathable fabric such as cotton. The length should be about 24 cm and the end width about 8cm.
2. Join the 3 pieces by sewing around the edges. Do not sew the overlapping straight edges together.
3. Taking some absorbent fabric, such as flannel or sweatshirt material, cut a rectangle 22cm by 28cm.
4. Fold the absorbent fabric 4 times so that it measures 22cm by 7cm and place it inside the casing.

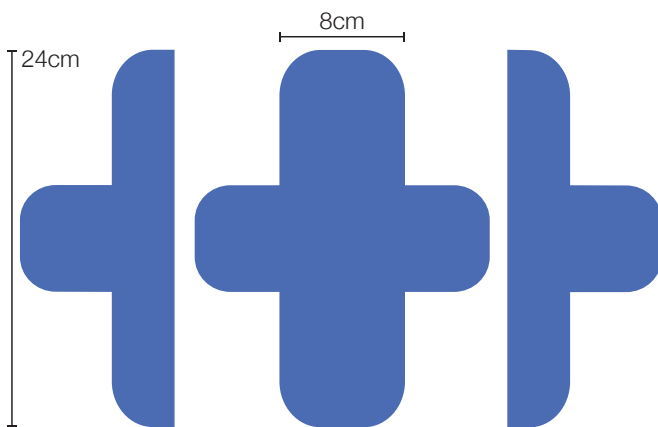

Roof

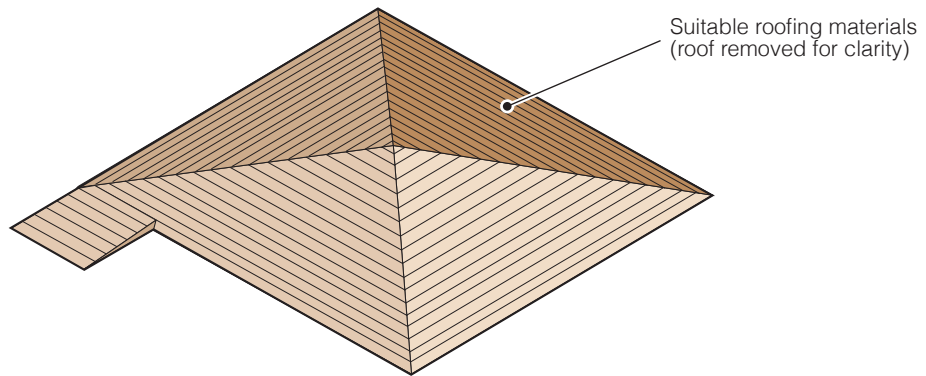

Construction view

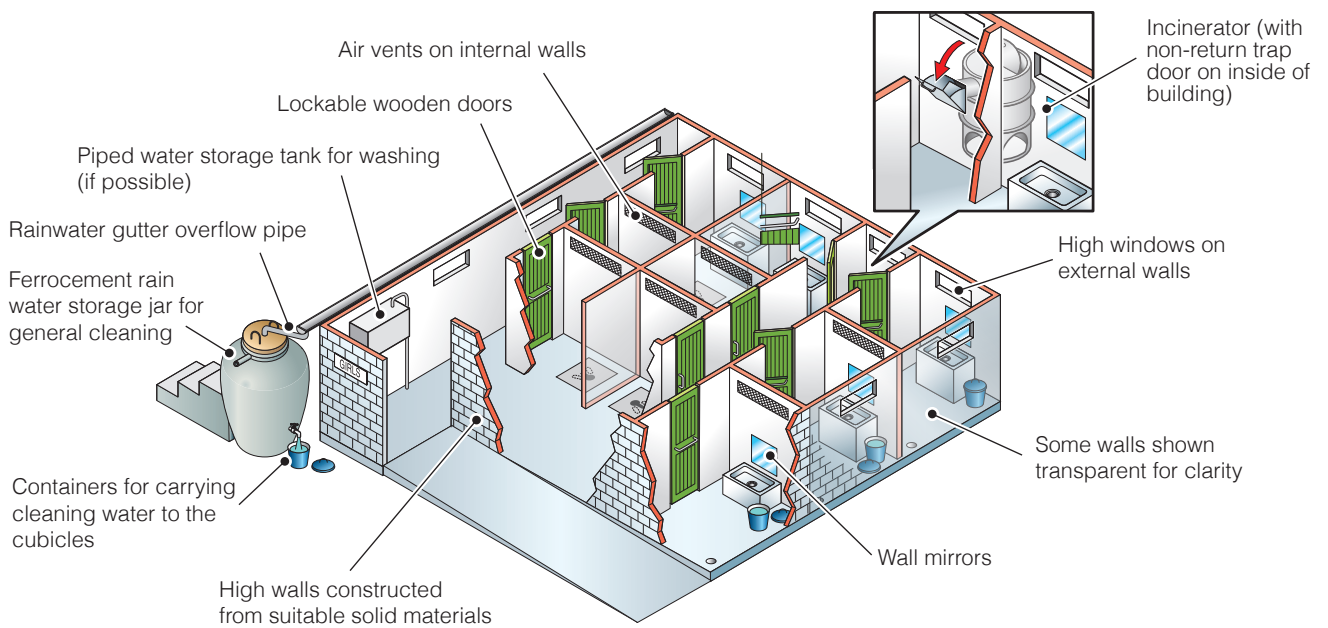

Floor plan view

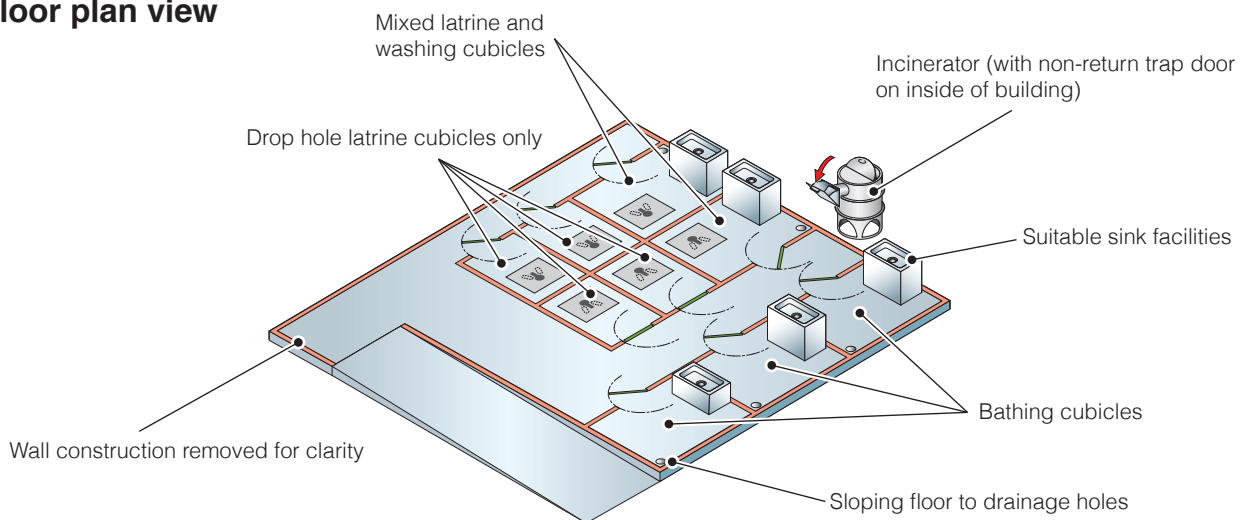

Figure 3. Schematic views of a sanitation block for girls including cubicles for bathing and washing

The Menstrual Cycle

The menstrual cycle occurs in the reproductive systems of women over the course of 28 days on average, although a cycle may vary anywhere from 20 to 40 days and still be considered normal.

Each month, lining tissue in the uterus develops in preparation for ovulation, when an egg (ova) is released from one of the ovaries. The ova travels to the uterus. If fertilized, the uterus lining provides nourishment for the embryo and the cycle ceases until the woman is no longer pregnant. If the egg is not fertilized, it disintegrates along with the outer layers of the uterus lining and then is discharged through the vagina with blood. This discharge is called the menstruation phase and, on average, lasts 5-7 days.

The menstrual cycle is affected by serious ill-health or disease, such that intervals between cycles may be extended and/or menstruation may only last a few days or continue for more than a week. Typically, malnutrition causes the menstruation phase to shorten.

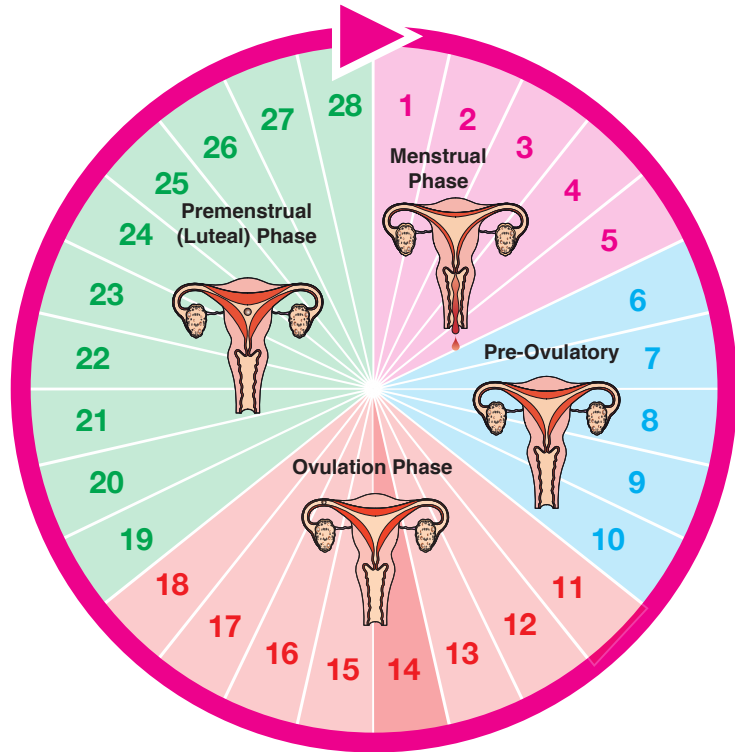

Menstrual Phase

The uterus lining breaks down and menstruation occurs

Pre-Ovulatory (Follicular) Phase

The uterus lining begins to thicken

Ovulation Phase

Ovulation takes place, usually on day 14

Premenstrual (Luteal) Phase

The uterus lining continues to thicken. If the egg is not fertilized, reproductive hormones diminish and the lining prepares to break down.

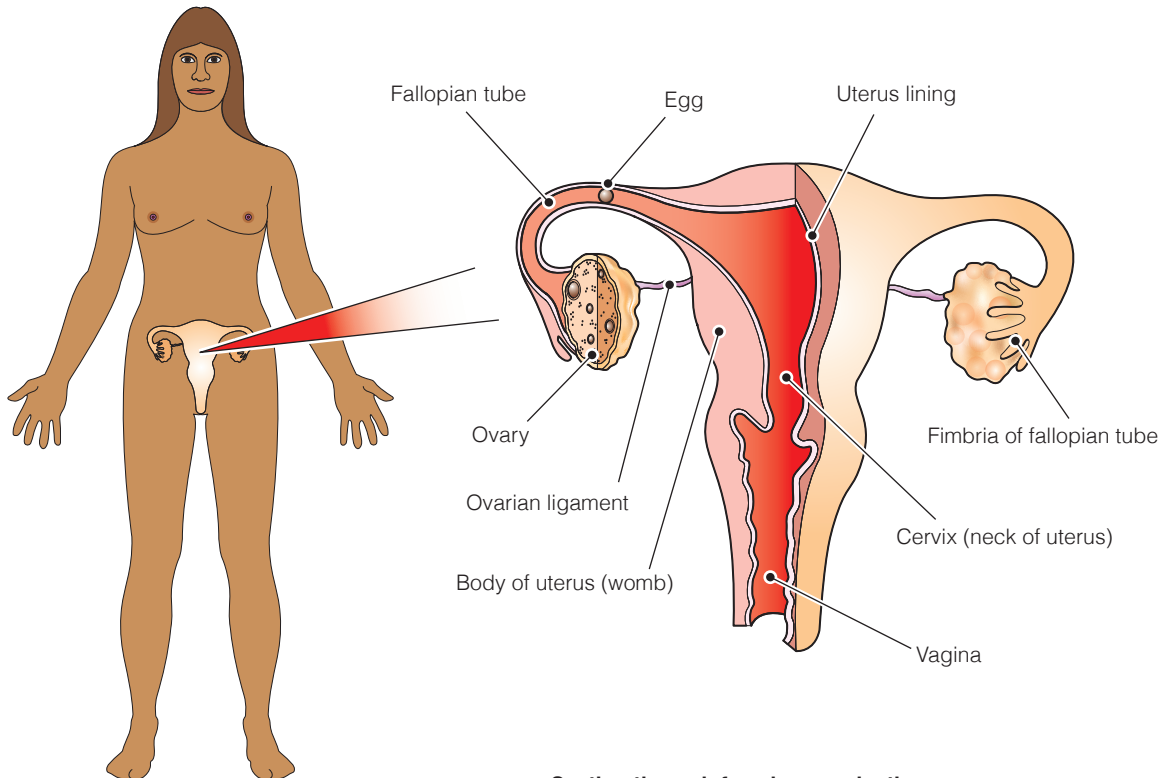

Section through female reproductive organs

4. Education

Pupils need to receive information about MHM, about the biological facts and practical ways of managing blood flow in a hygienic and discrete way. Both types of education are significantly lacking in most African schools. WASH practitioners can confront this problem by:

- establishing hygiene clubs, where older students teach younger students about MHM;
 - training teachers about how to convey biological facts in a sensitive manner;
 - providing IEC (information, educational and communication) materials about MHM;
 - de-linking the teaching of sex education from training in menstrual hygiene practices, to avoid causing ethical or religious offence;
 - strengthening the relationship between schools and health extension workers, who should be encouraged to visit schools and offer counselling services;
- and by
- focusing MHM education towards boys as well as girls, to foster more understanding attitudes and decrease social stigmas.

MHM and the WASH sector

Until recently MHM has been largely overlooked by the WASH sector. However, governments, institutions

and NGOs are realising that without addressing the problems associated with menstruation, the achievement of at least three Millennium Development Goals (MDGs) will be hampered (Tjon Ten, 2007), female school drop-out rates will remain high and the dignity of schoolgirls will be compromised.

There are few empirical studies about MHM at present, especially from sub-Saharan Africa. The studies that do exist have mostly been conducted in isolation and/or have not been widely published.

Consequently, there is not yet a coordinated approach to MHM nor adequate guidelines for WASH professionals. This is equally true in emergency settings, where robust humanitarian standards about women's monthly requirements remain undeveloped.

Much work still needs to be done to understand the MHM needs and practices of women in low-income countries. Breaking the silence of a taboo – a very real problem for millions of schoolgirls – is half the battle.

References

- CROFTS, T. 2010 *Will They Cotton On? An Investigation into Schoolgirls Use of Low-cost Sanitary Pads in Uganda*, unpublished MSc Dissertation, WEDC, Loughborough University, UK
- CROFTS, T. and FISHER, J. (2012) 'Menstrual Hygiene in Ugandan schools: Investigating Low-Cost Sanitary Pads', *The Journal of Water, Sanitation and Hygiene for Development*, 2, 1, 50-58
- HOUSE, S., MAHON, T., CAVILL, S. forthcoming. *Menstrual Hygiene Matters! To all: A Menstrual Hygiene Manual*. London: WaterAid
- REED, R.A. and SHAW, R.J. 2008. *Sanitation for Primary Schools in Africa*, WEDC, Loughborough University, UK
- SCOTT, L., DOPSON, S., MONTGOMERY, P., DOLAN, C. and RYUS, C. 2009. *Impact of Providing Sanitary Pads to Poor Girls in Africa*, Saïd Business School, Oxford University, Oxford. (Awaiting publication)
- TJON TEN, V. 2007. *Menstrual Hygiene: A Neglected Condition for the Achievement of Several Millennium Development Goals*. Europe External Policy Advisors, The Netherlands
- WATERAID, 2009. *Is Menstrual Hygiene and Management an Issue for Adolescent School Girls? A Comparative Study of Four Schools in Different Settings of Nepal*, Nepal, WaterAid
- WIKIA, 2010. *How to Make a Reusable Menstrual Pad* 'How to' series on Wikipedia. Available through www.en.wikipedia.org/wiki/Sanitary_napkin (Accessed 19/8/10)



Water, Engineering and Development Centre
The John Pickford Building
School of Civil and Building Engineering
Loughborough University
Leicestershire LE11 3TU UK

T: + 44 (0) 1509 222885 E: wedc@lboro.ac.uk
 F: + 44 (0) 1509 211079 W: [wedc.lboro.ac.uk](http://www.wedc.lboro.ac.uk)

The WEDC Knowledge Base

Become a Friend of WEDC and discover other free water and sanitation resources for downloading from our Knowledge Base. Visit: <http://wedc.lboro.ac.uk/knowledge/know.html>

