

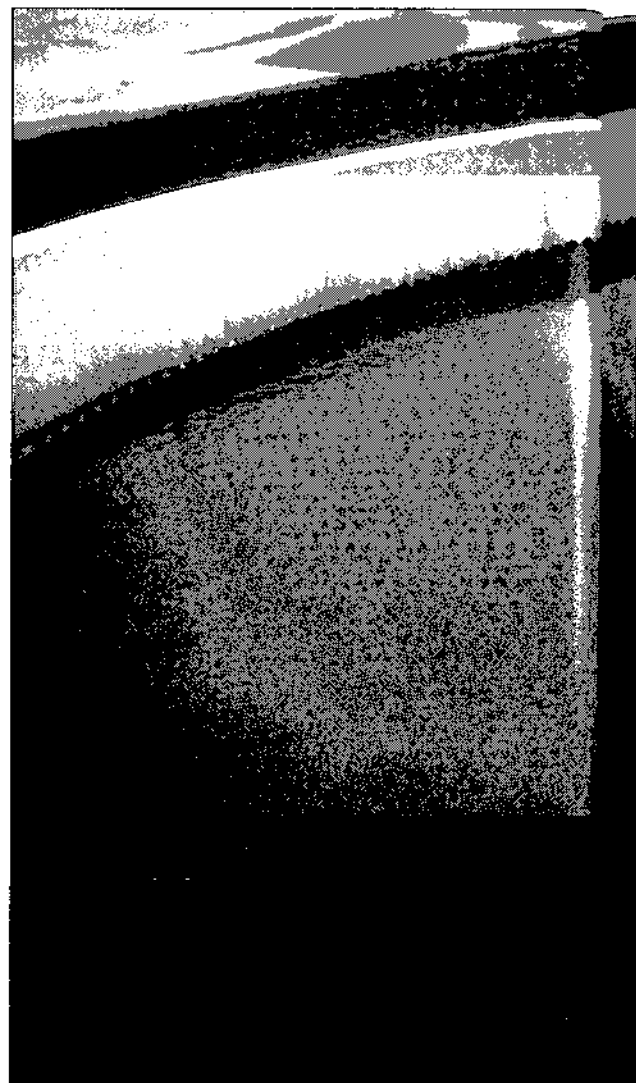

Waste stream recycling: its effect on water quality

Properly treated, blended, and monitored waste streams can be recycled through the water treatment process, thus relieving disposal problems and conserving water.

**David A. Cornwell and
Ramon G. Lee**



Supernatant from sludge thickener overflow is one of the main waste streams that can be recycled back into the water treatment process.



Water treatment plants generate various waste streams during the water production process as well as during subsequent waste-handling procedures. Waste streams can be a large volume, such as spent filter backwash water, which can make up more than 3 percent of plant production, or very small, like side streams of filtrate from a filter press, which may represent less than 0.1 percent of plant production.

Waste streams recycled to the influent of a water treatment plant typically contain contaminants at concentrations that are of concern. These contaminants may include *Giardia* and *Cryptosporidium*, trihalomethanes, manganese, and assimilable organic carbon. This research shows that proper management—treatment, equalization, and monitoring—of the waste streams can render them suitable for recycling in many situations.



Long storage time in sludge thickeners can facilitate release into the supernatant of contaminants removed during treatment.

Alternatives for disposal

Waste streams can be discharged to a sewer, discharged to a stream, or recycled within the treatment plant. If a sewer is available and the sewage plant can accept the waste, the discharge of small quantities of waste streams by this method may be appropriate. Discharge of large quantities of wastes (e.g., spent filter backwash water) may not be acceptable or economically desirable.

Direct discharge to waterways of clarified waste streams is a widely practiced disposal method. Generally, a discharge permit limits suspended solids (e.g., 30 mg/L) and pH (e.g., 6 to 9) for the water discharged. Several states are adding metal, chlorine, and toxicity standards to the discharge permit, making it increasingly difficult to discharge water treatment plant liquid wastes. Several plants are already considering zero discharge (complete plant recycle) as the only available option. Unfortunately, this option is complicated by some state health departments that are reluctant to permit recycle streams.

Recycling waste streams has the potential to disturb the treatment process itself or to affect the quality of the finished water. The adverse effects can be caused by the solids themselves, constituents in the waste, or contaminants released from sludge into the overlying water. Examples of undesirable constituents in waste include *Giardia* and *Cryptosporidium* cysts, manganese, iron, total organic

*A full report of this project, "Recycle Stream Effects on Water Treatment" (catalog #90629LH), is available from AWWA Customer Service (1-800-926-7337). Reports are free to AWWA Research Foundation subscribers by calling 303-347-6121.

TABLE 1 Parameters for evaluation at the six plant sites

Plant	Turbidity	TTHM	Mn	AOC	Parasites	Pressate	Drying Bed Filtrate
Mianus		X	X			X	
Swimming River		X	X	X		X	
Bangor	X				X		
Mohannon Valley	X				X		X
New Castle		X	X	X		X	
Kanawha Valley	X	X					

carbon (TOC), total trihalomethane (TTHM) precursors, and taste and odor. Although some plants have experienced problems with recycling waste streams, little published literature deals directly with the characteristics, problems, and requirements of effective side stream recycling.

Some of the possible effects of sludge storage in sedimentation basins were reported by Hoehn, Novak,

optimum operating or water quality conditions for minimizing adverse effects.

Research objectives

The principal objective of this research, which was supported by the AWWA Research Foundation,² was to evaluate the effect of recycling waste streams produced by drinking water treatment back to the head of the plant.

The main waste streams that can be recycled back to the water treatment process are classified as follows:

- spent-filter backwash water, either containing solids from filtration or not containing solids from filtration (after settling);
 - sludge thickener overflow (supernatant);
 - sludge lagoon overflow (supernatant); and
 - dewatering liquid wastes, which include pressate from filter press, pressate from belt press, centrate from centrifuge, and leachate from sand drying beds.
- Spent-filter backwash water is classified separately from the other wastes because it is often handled alone, it represents a large volume of water, and it is generally considered the cleanest of the waste streams. Spent-filter backwash water is subdivided into water containing the solids removed during filtration and water from which the solids have been removed prior to recycling.

Sludge stored in lagoons can be expected to degrade the overlying waters, thus complicating the discharge or recycling.

and Cumbie in 1987.¹ They found significant releases of manganese, iron, and TOC from sludge in manually cleaned sedimentation basins. Manganese concentrations in the water applied to the filters were higher than concentrations in the raw water. The researchers also concluded that sludge stored in lagoons can be expected to degrade the overlying waters, thus complicating the discharge or recycling of this supernatant.

The American Water Works Service Company (AWWSC), which is made up of more than 100 water plants, has also experienced the benefits and

Glossary

- C_A = cyst concentration in raw and recycle water
- C_{BW} = cyst concentration in spent-filter backwash water
- C_f = cyst concentration in filtered water
- C_i = cyst concentration in raw water
- C_R = cyst concentration in recycle water
- f_1 = factor increase in cyst concentration resulting from recycle

- K = fraction of cysts remaining after treatment of spent-filter backwash water
- Q = raw-water flow
- Q_{BW} = spent-filter backwash flow, equalized
- Q_R = recycle flow
- $TTHM_i$ = TTHM concentration in the raw water without recycle
- $TTHM_M$ = TTHM concentration in raw water mixed with recycle water
- $TTHM_R$ = TTHM concentration in the recycle stream



At the Williams Water Treatment Plant in Durham, N.C., a centrifuge is used to dewater the sludge mechanically.

Thickener overflow results from the thickening of sedimentation sludge or the thickening of sedimentation sludge plus spent-filter backwash water. In the latter case, the spent-filter backwash water is not considered separately because it has been mixed with sedimentation basin sludge. This overflow may also contain side streams from dewatering processes. Lagoon overflow is essentially the same as thickener overflow except that the solids storage time is considerably longer in a lagoon than in a thickener. This long storage time may alter the characteristics of the sludge and facilitate release of contaminants to the supernatant that is recy-

clered. The final waste stream category is the side streams associated with dewatering activities. These include the liquid streams that result from mechanical dewatering operations such as centrifugation or belt filter pressing or non-mechanical methods such as sand drying beds.

The research also considered potential contamination of the treatment process resulting from storage of sludge in sedimentation basins. In-basin sludge storage can directly affect the treatment process because of releases from the sludge into the settling basin overflow or clarified water.

Experimental methods

The first phase of this project was a survey of 24 AWWSC plants that had previously been identified as recycling one or more waste streams. The survey data identified the types of recycle streams, flow rates, and operator-noted effects of recycling.

FIGURE 1 Cyst mass balance for Bangor plant

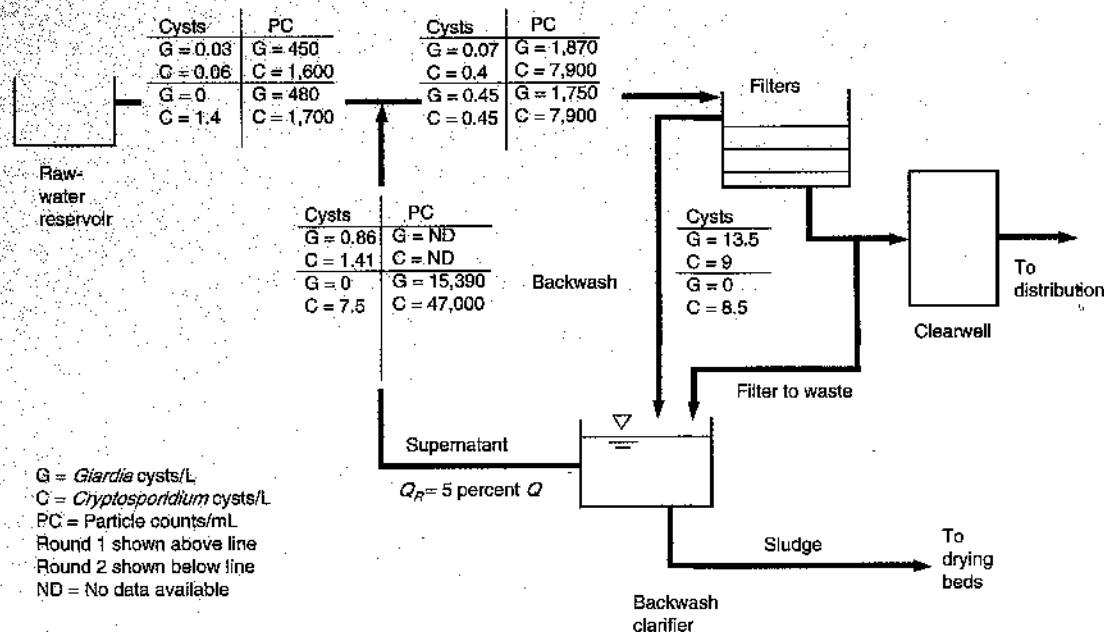
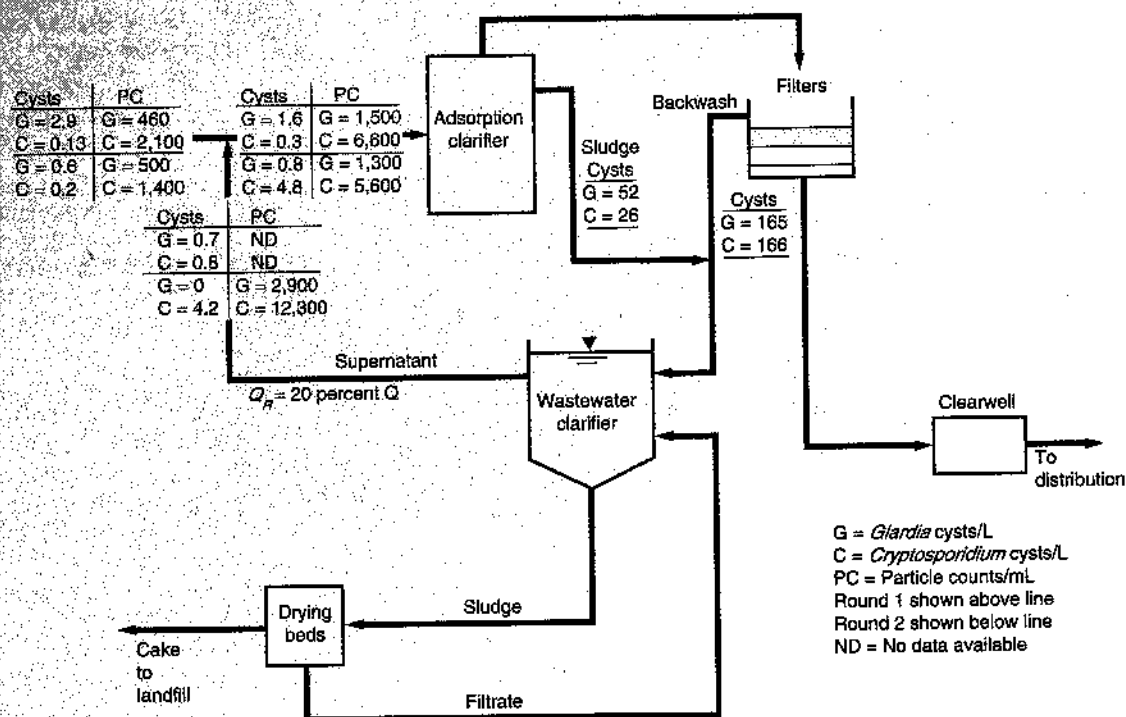

FIGURE 2 Cyst mass balance for Moshannon Valley plant



The next task associated with this phase of the work was to select approximately 12 plants that would be used for the first round of water quality sampling. In order to help rank the plants, they were categorized by potential problem areas: recycling of manganese, recycling of THM or THM precursors, recycling of *Giardia* or *Cryptosporidium*, effects of recycling on assimilable organic carbon (AOC), recycling of turbidity, effect of settling versus not settling backwash water, thickener and lagoon overflow, and dewatering side streams.

Preliminary sampling consisted of collecting a one-time grab sample of the recycled waste stream and of a process stream (usually settled water). The process stream was sampled before and during recycling in order to quantify the effects of recycling. The sampling results, along with system knowledge of the plants, were used to select six plants to study for the remainder of the project. The plants selected and the key parameters for further study are shown in Table 1.

Plant selection was also based on process facilities, so that a variety of plant types and waste-handling equipment would be included. For example, the group includes an in-line filtration plant (Bangor), an adsorption clarifier plant (Moshannon Valley), a conventional sedimentation plant (New Castle), and

Efficiency of filter removal of *Giardia*-size particles (5-15 μ m) at Bangor and Moshannon Valley plants

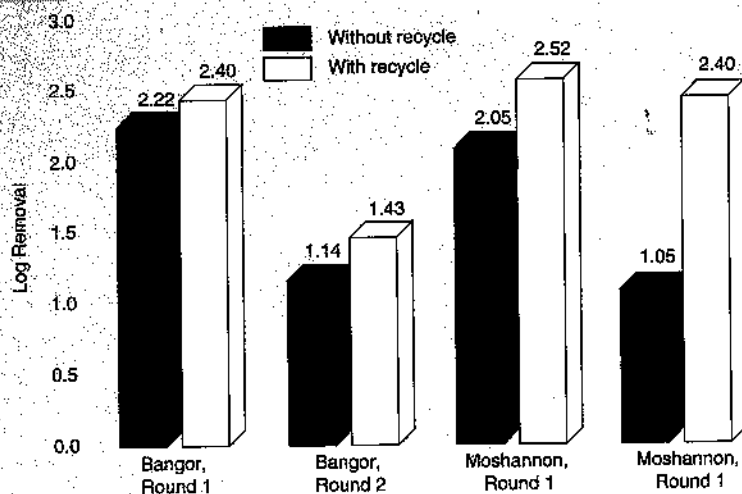

three sludge blanket plants. Three plants (Swimming River, Mianus, and New Castle) have belt filter presses and two (Moshannon Valley and Bangor) have sand drying beds.

In addition to these six plants, two non-AWWSC plants were used to study the effect of sedimentation basin sludge storage. These were the Williams Water Treatment Plant in Durham, N.C., and the Appomattox River Water Authority Plant in Petersburg, Va.

Results and discussion

Giardia and Cryptosporidium. Cyst concentrations were evaluated at the Bangor and the Moshannon Valley water treatment plants. The Bangor plant is a direct filtration plant that recycles settled spent-filter backwash water. At the Moshannon Valley plant, spent-filter backwash water and clarifier sludge are combined and settled. The supernatant from the waste-settling tank is recycled. In this research, the investigators looked at the level of cysts in the waste streams and the recycle water to help determine whether recycle streams could cause an increase in parasite levels in the production stream. In addition to being sampled for *Giardia* and *Cryptosporidium* cysts, the streams were analyzed for particle counts. Figures 1 and 2 show the data collected at the Bangor and Moshannon Valley plants on cysts and particle counts. In most all data presented, results are shown for round 1 and round 2, which were two different sampling events.

The spent-filter backwash water from both plants had high cyst concentrations compared with the raw water. Spent-filter backwash water at Moshannon Valley had *Giardia* and *Cryptosporidium* levels of >150 cysts/L. Bangor had levels of 8–14 cysts/L in the spent-filter backwash water. Raw-water cyst concentrations for the two plants were in the range of 0.05–3 cysts/L. Recycle streams at both plants, even after sedimentation, contained cyst levels higher than those of the raw water, and in general the recycle stream caused an increase in the cyst concentration in the treatment process feedwater.

Particle count data were also collected for the recycle stream, raw water, and mixed raw plus recycle, with key results shown in Figures 1 and 2. For Moshannon Valley, *Giardia*-size particles (5–15 μm) increased in the mixed water from ~500 counts/mL without recycling to 1,300–1,500 counts/mL with recycling. *Cryptosporidium*-size particles (2–4 μm) increased from 1,400–2,000 to 6,000–7,000 counts/mL,

FIGURE 4 Removal of *Giardia*-size particles (5–15 μm) from spent backwash water using sedimentation at Bangor plant

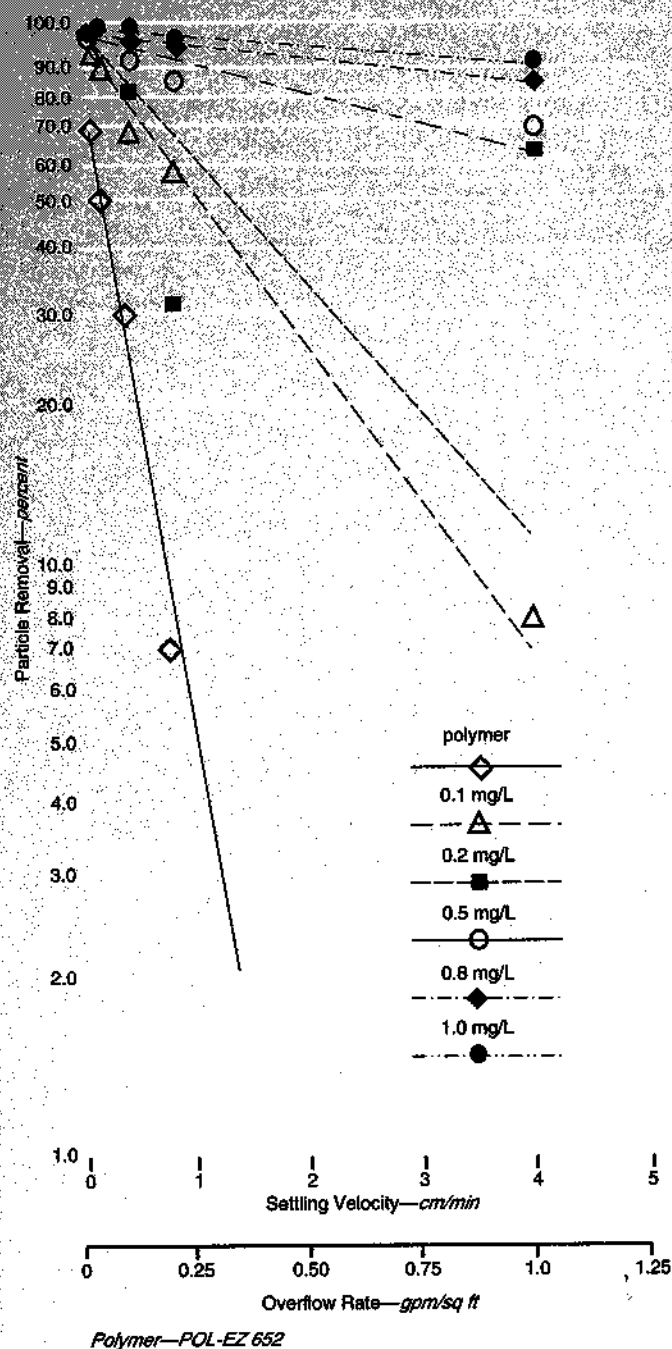

or both increased by a factor of ~3. At the Bangor plant, *Giardia*-size particles increased from ~450 to 1,800 counts/mL with recycling and *Cryptosporidium*-size particles increased from 1,600 to 7,900 counts/mL.

Although both plants showed an increase in particles in the raw water during recycling, filtered water was not affected. In fact, particle counts were slightly lower in the filtered water during recycle. Figure 3 summarizes the filter log removal efficiencies for *Gi-*

FIGURE 5 Flow diagram used for cyst mass balance calculations

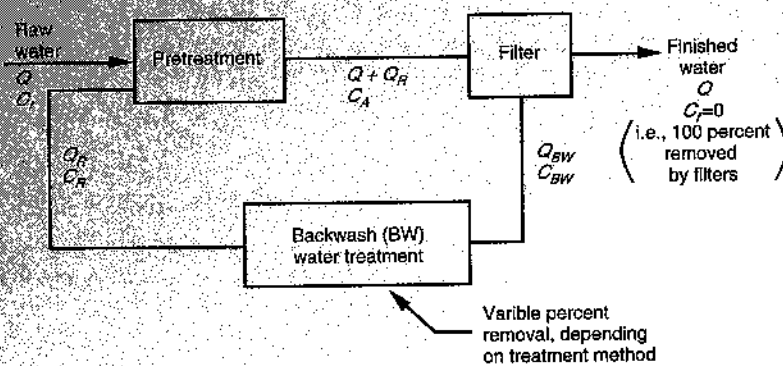

FIGURE 6 Particle loading to the treatment process with continuous recycling

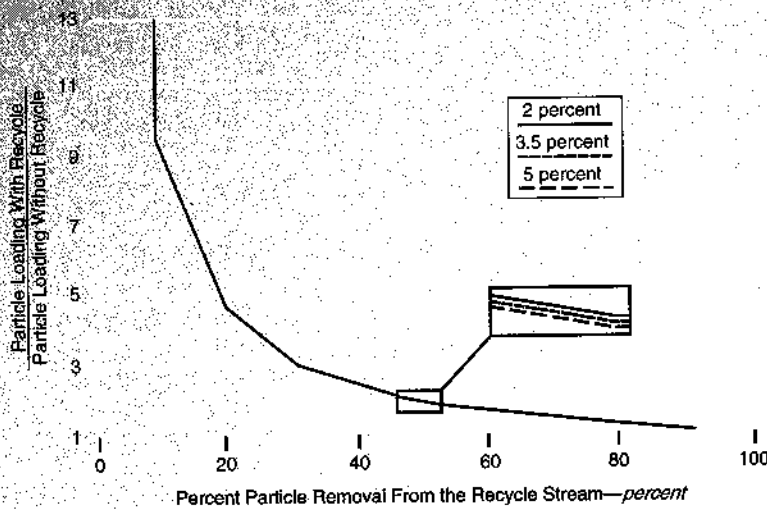
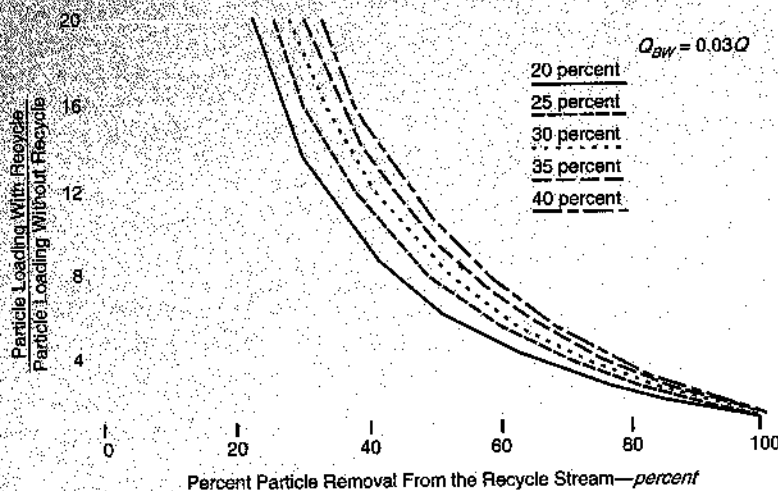

FIGURE 7 Particle loading to the treatment process with intermittent recycling



ardia-size particles at these plants. These results reflect the increased removal efficiency of the filters during recycling. Of course, log removal will generally be higher as the particles in the raw water increase, in this case as a result of recycling.

Both of the plants studied used sedimentation of the waste streams prior to recycling. In fact, both had relatively large settling tanks, and the solids removal efficiency was very good. At Moshannon Valley, recycling only increased the raw-water turbidity from 0.6 to 0.8 ntu. These low turbidity increases are indicative of the efficient settling of the spent backwash water prior to recycling. At Bangor the increase was from ~0.3 to 1.3 ntu. Laboratory settling studies were conducted at both plants to assess the importance of sedimentation of the waste streams prior to recycling on reducing cyst-size particles. An example of typical findings is shown for Bangor in Figure 4. This figure shows particle removal in the *Giardia* size range for different clarifier loading rates and different polymer dosages.

Full-scale correlation tests showed that the laboratory studies such as that depicted in Figure 4 gave an acceptable prediction of full-scale performance, with the conclusion that high overflow rates could result in low sedimentation efficiency and therefore higher cyst concentrations in the recycle stream. In fact, only very low overflow rates were successful in reducing cyst-size particles in the waste streams. Figure 4 also shows that addition of nonionic polymer was very useful in reducing the *Giardia*-size particles, as was found with all tests conducted. The same polymer was also useful in reducing *Cryptosporidium*-size particles.

A mass balance was computed using the flow diagram



of Figure 5 to determine the increase in cyst concentration loaded to the treatment process for different recycle ratios and for different degrees of settling efficiency of the spent-filter backwash water. In order to calculate the loading increase caused by recycling, it was assumed that the filters removed all the cysts and therefore that all the cysts applied to the filters ended up in the spent-filter backwash water. Second, it was assumed that no removal took place in the coagulation-sedimentation tank. This latter assumption is equivalent to an assumption that removal does take place during coagulation and that sludge from the sedimentation tank is also recycled. However, if coagulation removes cysts and the sludge is wasted rather than recycled, this mass balance does not apply.

Two scenarios were analyzed using these assumptions. The first was a steady-state situation in which the spent-filter backwash water flow (Q_{BW}) was equalized over a 24-h period and therefore was equal to the recycle flow (Q_R). (See glossary for explanation of symbols.) This would be a continuous recycling situation. The second situation involved intermittent recycling (with spent-filter backwash water treated and stored for periodic recycling).

For continuous recycling, the following would apply:

$$Q_R = Q_{BW} \quad (1)$$

$$C_{BW} = C_A (Q + Q_R)/Q_{BW} \quad (2)$$

$$C_R = KC_{BW} \quad (3)$$

The mass balance equation was formulated as

$$QC_i + Q_R C_R = (Q + Q_R) C_A \quad (4)$$

which resulted in

$$C_i/C_A = 1 + (Q_R/Q) - (KQ_R/Q) [(Q + Q_R)/Q_R] \quad (5)$$

This could be considered a simple expression:

$$C_A = f_1 C_i \quad (6)$$

in which f_1 represents the factor increase in cyst concentration in the water resulting from recycling. If there was no recycling, $f_1 = 1$ and $C_A = C_i$.

The intermittent recycling scenario represented a plant that recycled off and on throughout the day. Because in this case it was assumed that the operation had been steady, it was also assumed that the cyst concentration in the recycle stream had equalized and that the only variables were the recycle flow rate and removal efficiency. In this case Eq 4 was used, rearranged as

Mass diagram for manganese at the New Castle plant

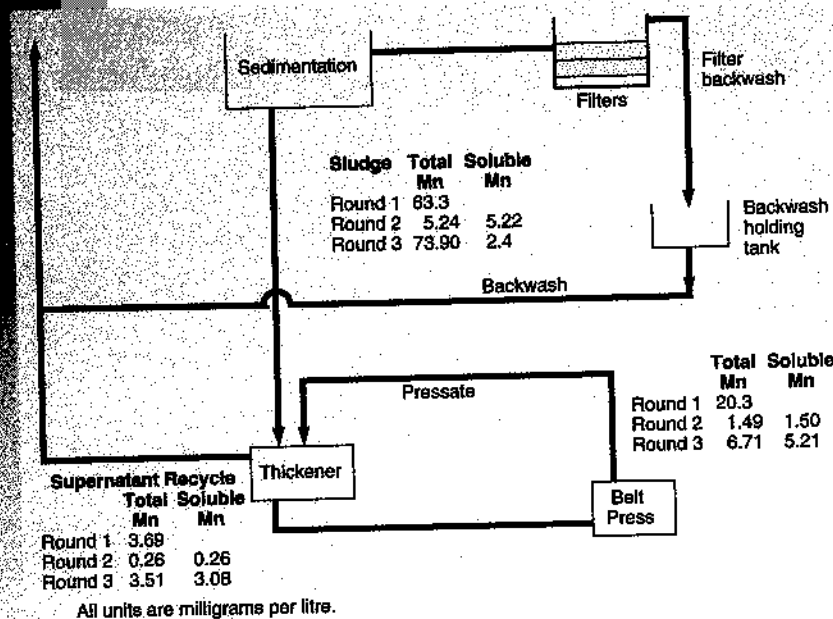

backwash water use is generally in the range of 3-5 percent of plant flow.

For the intermittent recycling condition, consider $Q_{BW} = 0.03Q$, as in the previous example, but now the spent filter backwash water is held and fed back into the plant at 20 percent of the raw flow ($Q_R = 0.2Q$). The value for C_R is found from Eqs 2, 3, and 6. For 90 percent treatment efficiency ($K = 0.1$)

$$C_{BW} = KC_A [(Q + Q_{BW})/Q_{BW}]$$

and it was already found that C_A at steady state equals $1.08 C_i$

$$C_R = 0.1 (1.08 C_i) \times [(Q + 0.03 Q)/0.03 Q]$$

$$C_R = 3.71 C_i$$

$$C_A = (QC_i + Q_R C_R)/(Q + Q_R) \quad (7) \quad \text{From Eq 7,}$$

and C_R was found from Eqs 2 and 3. The results could be expressed as

$$C_A = f_2 C_i \quad (8)$$

in which f_2 is defined as before.

An example use of the continuous recycling situation is illustrated for a 3 percent backwash water ($Q_R = Q_{BW} = 0.03Q$) and a spent-filter backwash water clarifier that is 90 percent efficient ($K = 0.1$) in removing cysts. From Eq 5,

$$C_i/C_A = 1 + (0.03Q/Q) - (0.1) \times (0.03Q/Q) [(Q + 0.03Q)/0.03Q]$$

$$C_i/C_A = 1 + 0.03 - 0.1 = 0.93$$

$$C_A = 1.08 C_i$$

or the applied cyst concentration was only 1.08 times greater with recycling than in the source water. However, if the removal efficiency dropped to 30 percent ($K = 0.7$), then

$$C_i/C_A = 1 + 0.03 - 0.72 = 0.31$$

In this case, the applied cyst concentration was 3.2 times higher with recycling than without.

Figure 6 shows various treatment efficiencies. This figure shows that the percentage increase in cyst loading to the filters is very dependent on settling efficiency but nearly independent of recycle ratio, as long as continuous recycling takes place. Note that

$$C_A = [QC_i + 0.2 Q (3.71 C_i)]/(Q + 0.2Q)$$

$$C_A = 1.45 C_i$$

or the slug loading to the plant with the recycled flow that is 20 percent of the raw flow is about 1.5 times the level without recycling and compares to 1.08 times with continuous recycling. At 30 percent treatment efficiency,

$$C_R = 0.7 (3.2 C_i) [(Q + 0.03 Q)/0.03 Q]$$

$$C_R = 76.91 C_i$$

and

$$C_A = [QC_i + 0.2 Q (76.91 C_i)]/(Q + 0.2Q)$$

$$C_A = 13.7 C_i$$

Figure 7 shows the significant effect that treatment of the recycle stream had on intermittent recycling operations. As treatment of the spent-filter backwash water was reduced, tremendous cyst loading to the filters could result.

Therefore, this research showed that waste streams can contain significant concentrations of *Giardia* and *Cryptosporidium* cysts. Particle counts in the size range of these cysts were correspondingly elevated. Without any removal of these particles from the waste

stream prior to recycling, the increased loading to the plant could be very high. Plain sedimentation of the spent-filter backwash water, particularly in the range of typical overflow rate design, may be very inefficient in removing the cysts. A plant removing only 20 percent of the particles prior to recycling and operating with an intermittent 20 percent recycle ratio could load the plant at more than 15 times the cyst concentration present in the original source water. Obviously, if a disruption in plant treatment occurs during a period of high cyst concentrations, then an inefficient or poorly operated recycle system can contribute to the situation. The important factors in reducing the loading are first to equalize the recycle rate so that it is continuous rather than intermittent and second to properly treat the waste streams for cyst removal prior to recycling. With continuous recycling and 80 percent treatment efficiency, the increased loading to the plant would only be ~1.2 times the source loading, which would probably be acceptable for most plants.

Manganese. The potential for high manganese concentrations in recycled waters was evaluated at several facilities and for different types of waste streams. Evaluations were also conducted at two plants to determine whether manganese is released from sludge stored in manually cleaned sedimentation basins. Some of the possible effects of sludge storage in sedimentation basins have previously been described by Hoehn, Novak, and Cumbie.¹ They reported significant releases of manganese, iron, and TOC from sludges held in manually cleaned sedimentation basins. They concluded that sludge stored in lagoons can also be expected to degrade the overlying water, thus complicating the discharge or recycling of this supernatant.

Data from the Mianus and New Castle water treatment plants, two plants sampled for manganese, are used to illustrate manganese levels obtained in various waters. Figures 8 and 9 show the waste stream-

FIGURE 9 Mass diagram for manganese at the Mianus plant

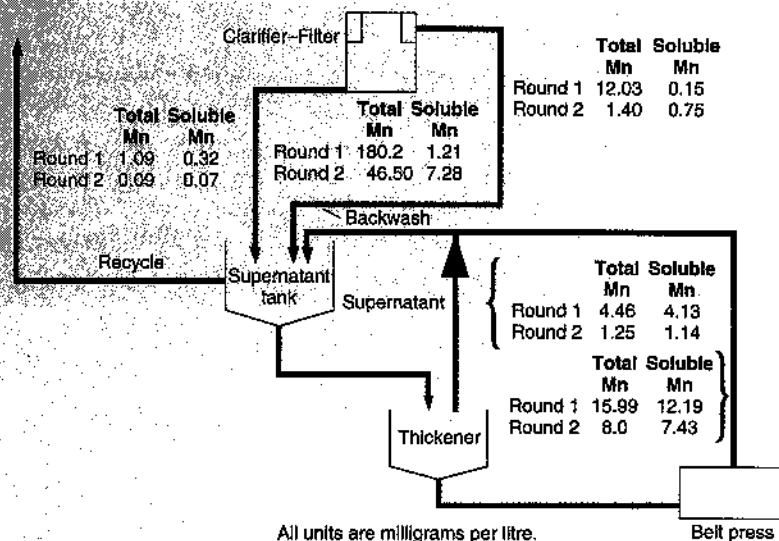
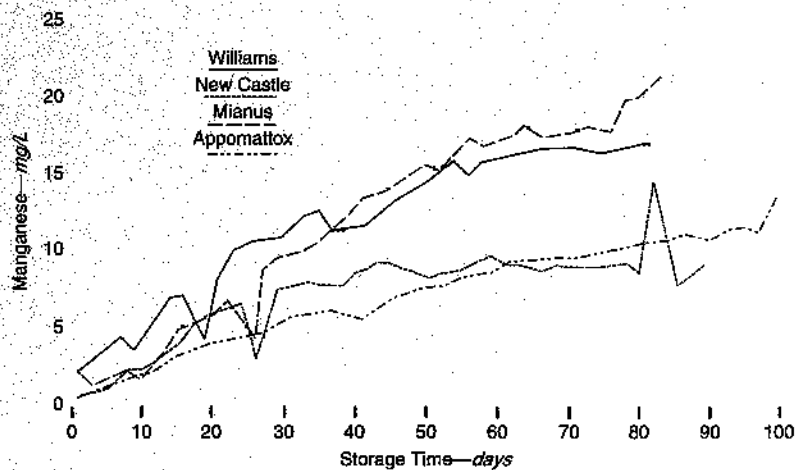
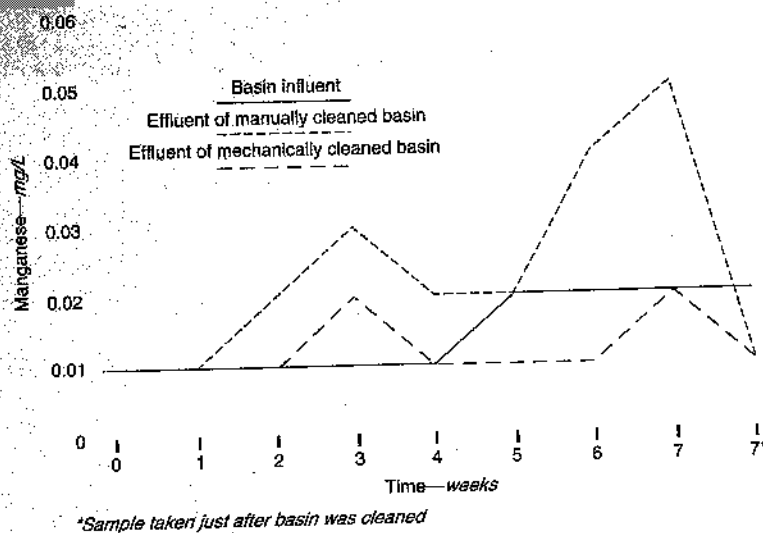

FIGURE 10 Release of manganese from several sludges during storage



handling schematics for these plants and the total and dissolved manganese concentrations of each waste stream analyzed. Both plants have methods for settling the waste streams before recycling. Both treatment plants had raw-water manganese concentrations in the 0.2–0.3 mg/L range at the time of sampling. The figures show that the sludge from the clarifiers at both plants had very high concentrations of total manganese; New Castle had levels of 65–75 mg/L manganese and Mianus reached 180 mg/L. Dissolved manganese levels in the waste streams were also quite high compared with the raw-water levels. Dissolved manganese was in the range of 1 to 7 mg/L in the sludge waste stream. In the recycle stream

FIG 11 Example of manganese released at Appomattox River plant



itself, soluble manganese is of most concern, because presumably this manganese is in the 2+ valence state and requires proper oxidation and sedimentation for removal. For the two samples at New Castle, the recycle streams contained soluble manganese levels of 0.2 and 3 mg/L, and at Mianus the levels were 0.07–0.3 mg/L.

The levels found indicate the large amount of manganese present in the solids of the waste stream and the potential for this manganese to be released to the water surrounding the sludge solids. Anaerobic

conditions should theoretically promote the release of manganese from the solids into the dissolved, liquid state, and therefore storage time would be a variable in promoting the dissolution of manganese from the solids in the sludge.

In order to assess the effects of storage in manganese release, several sludges were collected and stored in the laboratory, and dissolved manganese values were recorded with time. Figure 10 shows the results from four sludges stored over a three-month period. All sludges showed the same trend of releasing substantial amounts of manganese. The release began almost immediately

and, for most of the sludges, increased throughout the storage time. Clearly, manganese will continue to be released from sludge that is stored in a thickener. As the sludge ages, the concentration of manganese in the supernatant water increases.

If manganese could be released from sludge stored in a thickener, then it could be released from sludge stored in a manually cleaned sedimentation basin. Sludge was stored in manually cleaned sedimentation basins at two plants, and manganese levels into and out of the basin were monitored. Results from the

TTHMFP mass diagram for Mianus plant

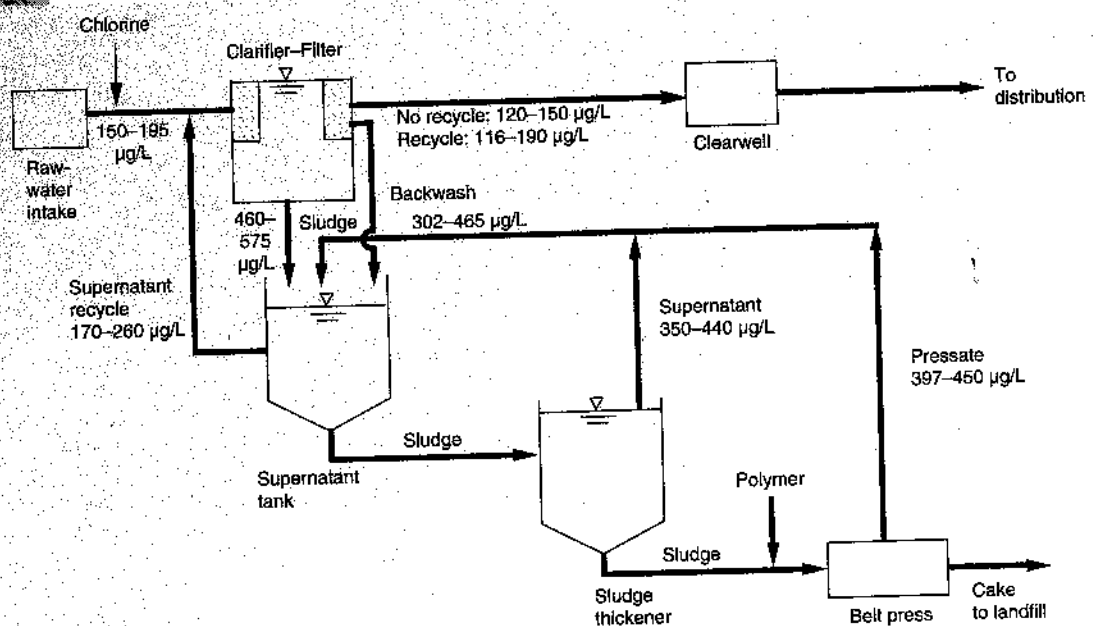

Appomattox River water treatment plant are shown in Figure 11. The data show that the dissolved manganese concentration leaving the sedimentation basin containing accumulated sludge was continually rising and consistently higher than the manganese concentrations leaving the continuously cleaned basin. In fact, the dissolved manganese level leaving the manually cleaned basin was higher than the level entering the basin, indicating a release from the stored sludge into the basin effluent.

From these data it was concluded that sludge contained in sludge thickeners or stored in sedimentation basins from manganese removal plants is characterized by low dissolved oxygen and high concentrations of dissolved manganese in the water surrounding the sludge solids. The manganese concentration in the sludge water will increase with storage time as more manganese is released from the solids. Some manganese will therefore be released to the thickener overflow and recycled to the head of the plant or will be released in the sedimentation basin and increase the applied filter manganese concentrations. Normally the manganese concentrations are low and controllable if properly monitored and treated, as was the case at the plants investigated in this research. However, if the sludge accumulation was allowed to occupy a significant portion of the thickener or basin, or if a hydraulic disruption occurred, then a situation could develop in which the large concentrations of manganese present in the sludge water could be flushed into the recycle stream or the sedimentation basin effluent. Plants should carefully monitor sludge blanket levels and manganese concentrations, and basins should be cleaned as often as possible. Careful consideration should be given to the use of manually cleaned sedimentation basins.

TTHM and TTHM formation potential. Concentrations of total trihalomethanes (TTHM) and THM precursors (measured as TTHM formation potential

FIGURE 13 TTHMFP mass diagram for New Castle plant

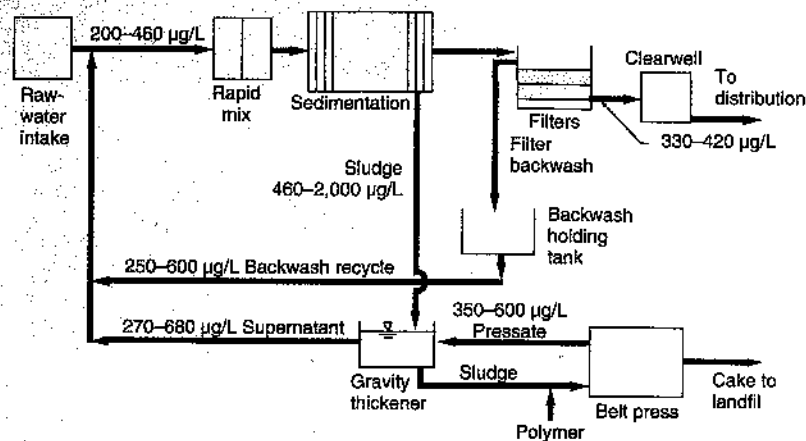
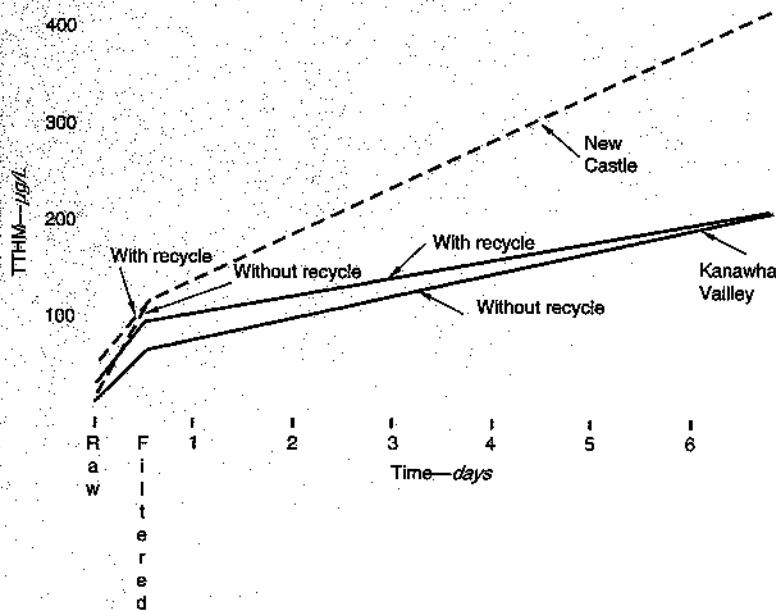

FIGURE 14 Kinetics of TTHM formation with recycling



[FP]) were evaluated at several facilities and on different types of waste streams. Figures 12 and 13 show the range of TTHMFP values that were found at various points in the Mianus and New Castle water plants. At the Mianus plant, raw-water TTHMFP ranged from 150 to 195 µg/L, and filtered values were 120-150 µg/L without recycling and 120-190 mg/L with recycling. The pressate, sludge thickener overflow, clarifier sludge, and spent-filter backwash water all had TTHM precursor concentrations greater than the raw- or finished-water levels. The thickener overflow had low solids concentrations, and the TTHMFP in that stream is primarily associated with the

FIGURE 16 Waste stream AOC concentrations at Swimming River plant

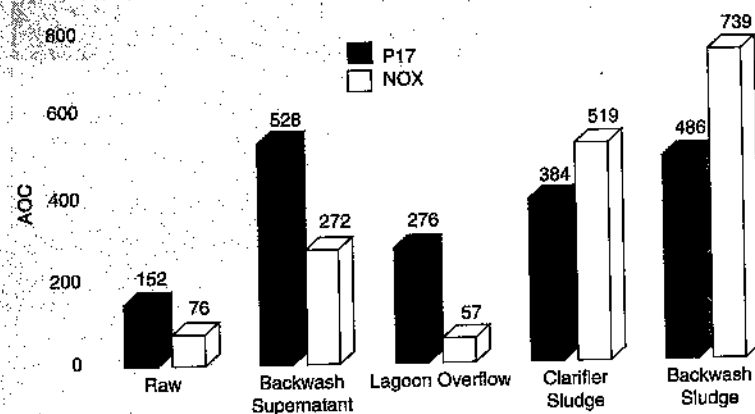

FIGURE 17 Example of waste stream AOC concentrations at New Castle plant

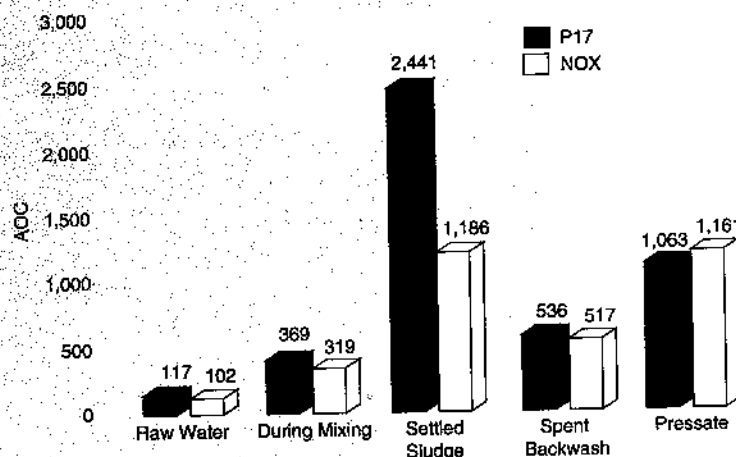
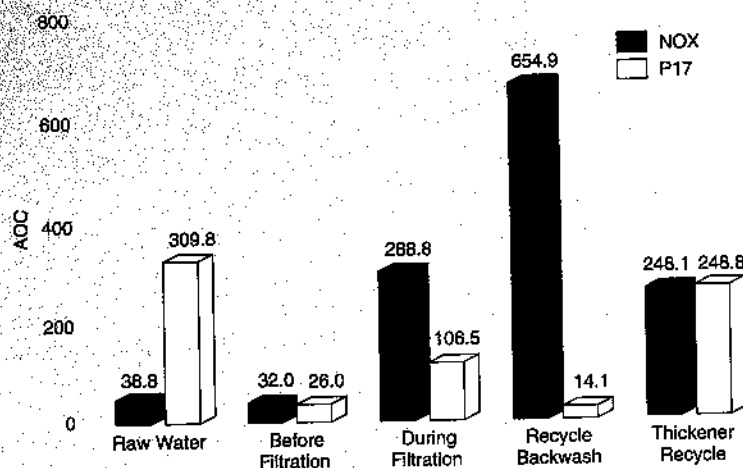

FIGURE 17 Example of AOC concentrations at New Castle plant with and without recycling



liquid phase. Because the TTHMFP was higher in these streams than in the raw water, it appears that some precursors were released from the solids into the thickener overflow. The excess TTHMFP associated with the clarifier flush and the spent-filter backwash appears to be associated with the solids with little release to the liquid phase, because settling of these wastes resulted in TTHMFP levels almost the same as in the raw or filtered water. Recycling of settled waste streams had very little, if any, effect on filtered TTHMFP. The New Castle plant showed very similar results. The waste streams with solids contained high TTHMFP, but settled streams had TTHMFP levels near that of the raw water. However, at New Castle one round of sampling did show elevated levels of TTHMFP in the recycle stream.

The recycle streams contained TTHM, which can form in the waste tanks as a result of the use of chlorinated backwash water. When the recycled water is mixed with the raw water, the net TTHM concentration in the plant influent will increase by the recycle ratios.

$$TTHM_m = [TTHM_R Q_R + TTHM_i Q] / Q_R + Q \quad (9)$$

Given this relationship, the influent water TTHM concentration will increase and, depending on formation kinetics, the finished-water TTHM level may also be higher. Figure 14 shows examples found at two of the plants studied. At the Kanawha Valley water treatment plant, the influent water TTHM concentration increased from 14 to 29 µg/L with the introduction of spent backwash water. This approximately 20-µg/L differential was carried through the plant such that the filtered water

had a TTHM concentration of 73 µg/L without recycling compared with 95 µg/L with recycling. No additional precursors were recycled, so the TTHMFP was the same with or without recycling. This is illustrated in Figure 14. The current TTHM regulations require sampling at different locations in the distribution system. At the Kanawha Valley plant, the first sampling points would show higher TTHM levels with recycling, whereas distant points would be about the same. Situations could be envisioned in which the recycle stream could cause an increase in a system's four-point TTHM average and cause a violation.

At the New Castle plant, the influent TTHM increased from 15 to 36 µg/L with recycling as shown in Figure 14. However, at this plant no effect on finished or distribution system water TTHM levels was observed.

AOC. AOC was monitored at the New Castle and Swimming River water treatment plants. Examples of AOC levels found in the waste streams at the two plants are shown in Figures 15 and 16. Generally, the waste streams had AOC levels much higher than the raw water. The waste streams at Swimming River had AOC levels of 270–740 compared with raw-water levels of 75–150. Levels in the waste streams were particularly high at the New Castle plant during the July sampling (Figure 15). The raw-water AOC was 200 compared with 3,600 in the sludge, 2,200 in the presate, and 1,000 in the spent-filter backwash water.

An increase in filtered-water AOC levels as a result of recycling was found in the January followup sampling at New Castle, as shown in Figure 17. The raw water had a total AOC of ~350 during this sampling. Without recycling, the filtered-water AOC was reduced by treatment to about 60. With recycling, the filtered-water AOC was almost 400. In a May sampling, the filtered-water AOC was 24 without recycling and 107 with recycling.

It appears that waste streams contain higher AOC levels than the raw-water levels. The recycling of AOC can increase the filtered-water AOC, which may promote regrowth problems in the distribution system.

Conclusions

Waste streams that are recycled to the front end of a water treatment plant typically contain contaminants at levels that are of concern. However, proper management of the waste streams can render them acceptable for recycling in many situations. As a general rule, the recycle streams should be equalized and blended in over a 24-h time period (or the plant's operating cycle if less than 24 h). The rule of thumb that recycle should be <10 percent of the plant flow does not necessarily meet the criteria of complete equalization. The recycle streams should also be regularly monitored for the contaminant (or surrogate) of concern. Manually cleaned sedimentation basins should be avoided or the quality of the clarified water should be closely monitored.

Giardia and *Cryptosporidium* can be present in high numbers in spent-filter backwash water and sedi-

mentation basin sludge. They can be removed from the waste streams by sedimentation, either at a low overflow rate or by polymer assistance. Achieving a given turbidity or suspended solids reduction is not sufficient to assure parasite removal. Either direct cyst monitoring or particle counting should be used to judge the effectiveness of cyst removal from the waste stream prior to recycle.

It appears that proper solids removal from the waste streams also eliminates the recycling of excess TOC. This research suggests, however, that TOC be checked, especially in light of the enhanced coagulation requirements.

Preformed THM is generally recycled along with a spent backwash water. The effect that this THM may have on a plant meeting the THM requirements needs to be evaluated on a site-specific basis. Although not evaluated in this research, haloacetic acids (HAA) would presumably also be recycled. Situations could occur in which the THM or HAA in recycle streams contributes to a system's failure to meet an MCL. In this case, recycling may need to be discontinued or more sophisticated treatment provided.

Sources with manganese present in the raw water or in the coagulant will have manganese in the recycle stream. Manganese in the recycle is greatly reduced by removing the suspended solids from the waste stream. Sludge blankets in thickeners should be kept low to reduce the chance for significant manganese carryover, and hydraulic disruptions should be avoided. Manually cleaned sedimentation basins should be avoided for plants that have significant manganese in their sludge. Equalized recycling is critical to avoiding a spike.

Proper treatment, equalization, and monitoring can be used to make recycling an important part of plant operations and allow for water conservation and zero discharge.

References

1. HOEHN, R.C.; NOVAK, J.T.; & CUMBIE, W.T. Effects of Storage and Preoxidation on Sludge and Water Quality. *Jour. AWWA*, 9:6:67 (June 1987).
2. CORNWELL, D.A. & LEE, R.G. Recycle Stream Effects on Water Treatment. AWWA Res. Fdn., Denver, Colo. (1993).



About the authors: David A. Cornwell is president of Environmental Engineering & Technology Inc., 712 Gum Rock Court, Newport News, VA 23606. A member of AWWA and a contributor to JOURNAL AWWA on the subject of treatment plant residuals, Cornwell was a 1986 recipient of AWWA's best paper award in the Engineering and Construction Division. He holds a doctoral degree from the University of Florida, Gainesville. Ramon G. Lee is president of Illinois-American Water Company, 300 N. Waterworks Dr., P.O. Box 24040, Belleville, IL 62223-9040.