

INTERNATIONAL REFERENCE CENTRE
FOR RURAL WATER SUPPLY AND
SANITATION (IRC)

**THE DEVELOPMENT
OF
THE RURAL WATER SUPPLY AND SANITATION SECTOR
IN
ZIMBABWE BETWEEN 1974 AND 1987:
THE DESIGN AND IMPACT OF DONOR SUPPORTED PROJECTS**

**BY
ROBERT A BOYDELL**

May 1990

824-ZW-11548

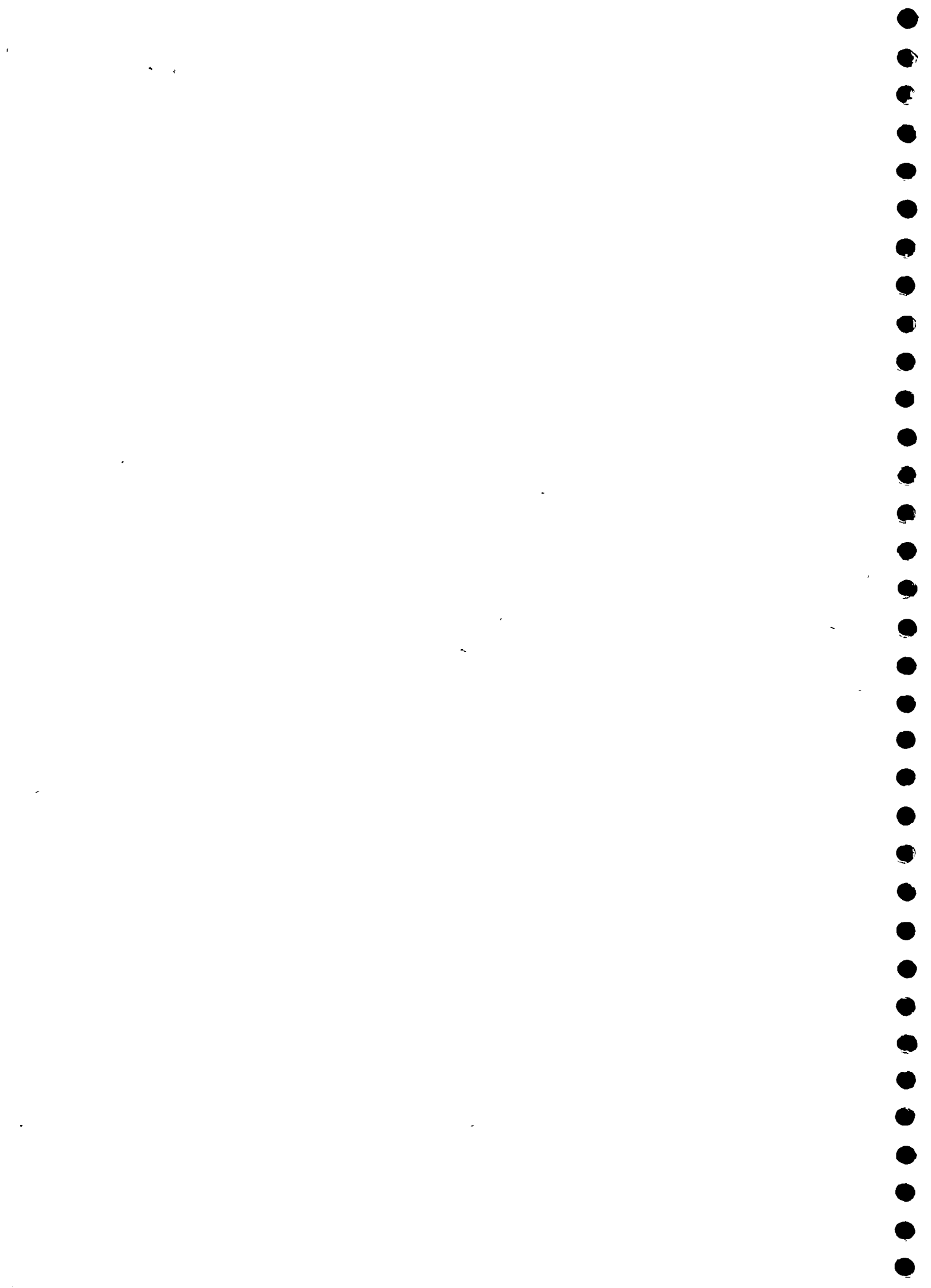

**THE DEVELOPMENT
OF
THE RURAL WATER SUPPLY AND SANITATION SECTOR
IN
ZIMBABWE BETWEEN 1974 AND 1987:
THE DESIGN AND IMPACT OF DONOR SUPPORTED PROJECTS**

**BY
ROBERT A BOYDELL**

May 1990

Y12

12/12/12



THE DEVELOPMENT
OF
THE RURAL WATER SUPPLY AND SANITATION SECTOR
IN
ZIMBABWE BETWEEN 1974 AND 1987:
THE DESIGN AND IMPACT OF DONOR SUPPORTED PROJECTS

BY
ROBERT A BOYDELL

This is a copy of the Doctoral Thesis submitted by
R.A.Boydell to Loughborough University of Technology

© by Robert Arthur Boydell, 1990. All Rights Reserved.

BARCODE 11548
824 ZW90

Abstract

The Development of the Rural Water Supply and Sanitation Sector in Zimbabwe between 1974 and 1987: The Design and Impact of Donor Supported Projects

Although the International Drinking Water Supply and Sanitation Decade has generated great interest from foreign aid donors, its impact in terms of increased service levels has been poor. These disappointing results have been explained by the UN and other donors in terms of inadequate funding and lack of cost recovery, poor operations and maintenance, lack of personnel, unacceptable technology, poor logistics and non involvement of the beneficiaries. However, an alternative explanation revolves around factors contributing to poor project design. These include the lack of understanding of the development process, donor bias and self interest, and poor coordination and commitment by the recipient government. A review of the development and trends of contemporary aid philosophy and its translation in to rural development and water and sanitation projects, which led to the launch of the IDWSSD, provides a number of lessons that can be used to formulate a hybrid model for project design and the sector development process, that defines the relative roles of donors, recipient governments and people themselves. The model is based on coordinated development, community participation, and sector growth from pilot projects to large scale programmes.

The developments in the rural water and sanitation sector that took place in Zimbabwe from 1974 to 1987, provide a unique opportunity to test this model using a systems analysis approach. After gaining independence in 1980, Zimbabwe's development assistance funding grew tenfold with the influx of foreign donors, and major commitment were made by the new Government to rural development and the goals of the IDWSSD. However, the large investments in water and sanitation which included the preparation of a national master plan with external technical assistance, had both positive and negative impacts on the continuing development of the sector, the start of which can be traced back, well before Independence, to small pilot projects sponsored by non government organizations that used appropriate technology developed by the Rhodesian Government. This development process and the changing approach to project design is illustrated by a series of case studies of projects supported by multilateral and bilateral donors, and non government organizations, that were milestones during this period.

Finally the project and sector development model is modified based on the practical lessons from Zimbabwe and recommendations for future practice are made together with suggestions for areas of further research.

The Development of the Rural Water Supply and Sanitation
Sector in Zimbabwe from 1974 to 1987:
the Design and Impact of Donor Supported Projects
by
Robert Arthur Boydell

KEY WORDS

WATER
SANITATION
RURAL
ZIMBABWE
AID
DONORS
DEVELOPMENT
PLANNING
CASE STUDIES
PROJECTS
EVALUATION
COMMUNITY PARTICIPATION
NON GOVERNMENT ORGANIZATIONS
INTERNATIONAL DRINKING WATER SUPPLY AND SANITATION DECADE
MASTER PLANS
TECHNICAL ASSISTANCE
SYSTEMS ANALYSIS

Robert Arthur Boydell

Acknowledgments

I wish to express my gratitude to the Government of Zimbabwe, Interconsult and the various aid agencies referred to in this thesis for their collaboration and cooperation particularly in making data readily available.

I also wish to acknowledge the generosity of Professor John Pickford, Head of the Water, Engineering and Development Centre, and Professor R A Butlin, Head of the Department of Geography for the facility of working in their Departments.

Particular thanks is given to my supervisor Doctor Morag Bell for her unfailing enthusiasm, support and encouragement without which this thesis would not have been completed. I am also indebted to Doctor Marilyn Aitkenhead, until recently a member of the Department of Management Studies, for her suggestions and invaluable comments on the many drafts.

Grateful recognition of cooperation and assistance is also given to the Government officials, extension workers, and enumerators, too many to list, but without whom this thesis would have not been possible. Finally, I must record my appreciation of my wife who accompanied me in Zimbabwe, especially for her patience.

Statement of Responsibility and Originality

The author was a senior member of a water and sanitation master planning team based in Zimbabwe during 1984, having been seconded from the World Bank/United Nations Development Programme's Technology Advisory Group to a consulting company funded from the Norwegian bilateral aid organization, NORAD. During this period he carried out detailed studies of the water sector and led the evaluation of a number of rural water supply and sanitation projects.

Subsequently the author took up the post of Rural Water Supply and Sanitation Development Adviser in the Ministry of Health which he occupied during 1985 and 1986, during this period he worked with international donors and non government organizations in developing a national rural water supply and sanitation programme and in further detailed evaluations of various rural water supply and sanitation projects funded by the Zimbabwean Government, the United Nations Childrens Fund, Deutsche Gesellschaft Fur Technische Zusammenarbeit (GTZ), Save the Children Fund, and the Catholic Social Services Development Commission.

This thesis draws from data collected during the master planning study and the subsequent project evaluations. However, the opinions expressed herein are those of the author and do not represent views held by the World Bank, the United Nations Development Programme, the Government of Zimbabwe, other donors or consultants.

List of Contents

	Page
Acknowledgments.....	i
Statement of Responsibility and Originality.....	ii
List of Contents.....	iii
List of Tables.....	viii
List of Figures.....	x
List of Acronyms.....	xii
Definitions.....	xv
Map of Zimbabwe.....	xxii
<u>Chapter 1 - The International Drinking Water Supply and Sanitation Decade and Systems Analysis</u>	
1.1 Problem Statement.....	1
1.2 Hypothesis.....	3
1.3 A Systems Approach to Rural Water Supply and Sanitation Sector Analysis.....	8
1.4 Zimbabwe as a Case Study.....	20
1.5 Thesis Structure.....	20
<u>Chapter 2 - Foreign Aid - Trends and Issues, and the Origins of the International Drinking Water Supply and Sanitation Decade</u>	
2.1 Foreign Aid - Trends and Issues.....	24
2.2 The Dethroning of GNP.....	27
2.3 A Basic Needs Approach.....	29
2.4 Primary Health Care and Rural Water Supply and Sanitation as a Basic Need.....	33
2.5 The Appropriate Technology Movement.....	36
2.6 The Origins of the International Drinking Water Supply and Sanitation Decade.....	38
2.7 Present Views on Aid Policy and Issues.....	39
2.8 Technical Assistance and Professional Bias.....	42
2.9 Non Government Organizations - The Voice of the People.....	44
2.10 Summary.....	46

Chapter 3 - The Evolution of Rural Development and Water Supply Projects and a Model for Rural Water Supply and Sanitation Project Design and Sector Development

3.1	The Evolution of Rural Development Project Design.....	48
3.2	Present Practice in The Design of Rural Development Projects.....	52
3.3	The Evolution of Rural Water Supply and Sanitation Project Design.....	56
3.4	Linkages and Parallels in Water and Rural Development Project Design.....	71
3.5	Project Components - The Present Research Trend in Rural Water Supply and Sanitation.....	72
3.6	Summary and Model for Rural Water Supply and Sanitation Development.....	75

Chapter 4 - Rural Development in Zimbabwe

4.1	General Description.....	83
4.2	The Legislative and Administrative Structure.....	89
4.3	The Socio Political Structure and Planning Structure.....	90
4.4	Extension Services.....	92
4.5	Rural Development Policy.....	98
4.6	Summary.....	104

Chapter 5 - The Water and Sanitation Sector in Zimbabwe

5.1	Water facilities and Use in Communal Areas.....	108
5.2	Appropriate Technology Development.....	112
5.3	Constraints to Rural Water Supply Development.....	114
5.4	Ability and Willingness to Pay for Water and Sanitation.....	117
5.5	Overlapping Institutional Responsibility.....	118
5.6	Donor Support to the Sector.....	124
5.7	Interministerial Coordination and the International Drinking Water Supply and Sanitation Decade in Zimbabwe.....	128
5.8	Summary.....	129

Chapter 6 - The National Master Plan for Rural Water Supply and Sanitation and NORAD's Long Term Programme

6.1	The National Master Plan for Rural Water Supply and Sanitation.....	132
6.2	The NORAD Long Term Programme.....	135
6.3	Summary.....	138

Chapter 7 - Evaluation Methodology for Rural Water Supply and Sanitation Project Case Studies

7.1	The Projects Studied.....	143
7.2	Evaluation.....	144
7.3	Evaluation of the Temporal Aspects of Development...	146
7.4	A Case Study Approach in the Presentation of Project and Programme Evaluations.....	146
7.5	Project Evaluation Methodologies.....	148
7.6	Data Collection and Analysis.....	151
7.7	Project Design Analysis.....	152

Chapter 8 - St. Theresa's Mission Water Supply and Sanitation Project in Chilimanzi

8.1	Background.....	153
8.2	Planning.....	157
8.3	Implementation.....	158
8.4	Findings and Results.....	161
8.5	Lessons to be Learned from the Project.....	163

Chapter 9 - The Commission for Social Services Development Water and Sanitation Project in Mashonaland

9.1	Background.....	168
9.2	Planning.....	171
9.3	Implementation.....	172
9.4	Findings and Results.....	175
9.5	Lessons to be Learned from the Project.....	177

Chapter 10 - The Ministry of Health Pilot Projects in Mhondoro, Serima and Zimutu and the Subsequent MOH Expanded Programme

10.1	Background.....	182
------	-----------------	-----

10.2	Planning.....	189
10.3	Implementation.....	190
10.4	Findings and Results.....	193
10.5	The MOH Expanded Programme.....	193
10.6	Lessons to be Learned from the Project.....	196

Chapter 11 - The GTZ Villages Water Supply and Sanitation Programme in Masvingo Province and the Coordinated Agriculture and Rural Development Programme in Gutu District

11.1	Background.....	203
11.2	Planning.....	206
11.3	Implementation.....	208
11.4	Findings and Results.....	209
11.5	Lessons to be Learned from the Project.....	212

Chapter 12 - The United Nations Childrens Fund Wells Programme in the Matabeleland Provinces

12.1	Background.....	217
12.2	Planning.....	221
12.3	Implementation.....	223
12.4	Findings and Results.....	226
12.5	Lessons to be Learned from the Project.....	229

Chapter 13 - The Lutheran World Federation Wells Sinking Programme in the Matabeleland Provinces

13.1	Background.....	233
13.2	Planning.....	236
13.3	Implementation.....	237
13.4	Findings and Results.....	239
13.5	Lessons to be Learned from the Project.....	242

Chapter 14 - The NORAD Crash Borehole Drilling and Long Term Programmes in Mashonaland and Manicaland Provinces

14.1	Background.....	246
14.2	Planning.....	250
14.3	Implementation.....	251
14.4	Findings and Results.....	253
14.5	Lessons to be Learned from the Project.....	255

<u>Chapter 15 - Other Rural Water Supply and Sanitation Projects</u>	
15.1	General description.....259
15.2	The DANIDA Funded Rural Water Supply and Sanitation Projects in Midlands and Matabeleland North Provinces.....260
15.3	The SIDA Funded Primary Health Care Programme in Manicaland.....262
15.4	The Save the Children Fund Primary Health Care Project in Binga, Matabeleland North Province.....263
15.5	Lessons to be Learned from the Projects.....264
 <u>Chapter 16 - Summary of Case Study Findings</u>	
16.1	The Sector Development Process that Took Place.....275
16.2	The Design and Implementation of the Case Study Projects.....280
16.3	The Role of Donors, Government and Community.....288
 <u>Chapter 17 - Conclusions and Recommendations</u>	
17.1	General Comments.....297
17.2	Redefining Communities and Vertical Projects.....302
17.3	A Model Rural Water Supply and Sanitation Sector Development Process.....303
17.4	A Model for the Design of Rural Water Supply and Sanitation Development Projects.....305
17.5	The Role of Governments, Donors and Communities in Projects and Sector Development.....310
17.6	Water and Sanitation Master Planning.....313
17.7	The Need for Further Research.....313
17.8	The Value of a Systems Analysis Approach.....315
 Annex 1 - WHO Minimum Evaluation Procedure For Water and Sanitation Projects.....316	
Annex 2 - Sample Protocols For the Technical Inspection of Wells and Latrines.....324	
Annex 3 - The Logical Framework - an Analytical Tool for Project Evaluation and Design.....329	
Annex 4 - A Check List of Questions to Ask When Evaluating Development Projects.....333	
Bibliography.....344	

List of Tables

	Page
1. Initial Systems Root Definitions Using CATWOE Characteristics.....	19
2. Summary of a Conceptual Supra Systems Model for Rural Water Supply Sector Development Based on Contemporary Approaches.....	77
3. Projected Rural Population in 1990 1995 and 2005 in Communal Areas by Settlement Classification.....	87
4. Most Important Rural Development Needs as Perceived by Mothers and Heads of Households in the Sabi Valley Manicaland.....	87
5. Range of Extension Workers in Zimbabwe.....	93
6. Range of Locations From Which Domestic and Drinking Water is Obtained in Rural Areas by Traditional and Improved Sources.....	110
7. Distribution of Sanitary Facilities by Province.....	110
8. Comparison of Rural Income Level Data Derived From National and In-depth Local Studies.....	119
9. Ability to Pay for Water in Rural Areas.....	119
10. Willingness to Pay for an Improved Pit Latrine in Rural Areas.....	119
11. List of Development Agencies Supporting the Rural Water Supply and Sanitation Sector in Zimbabwe.....	125
12. Summary of Systems Analysis for the Preparation of the NMPRWSS.....	141
13. Mix of Evaluation Techniques for Each Project.....	150
14. Summary of Systems Analysis for St. Theresa's Project.....	165
15. Summary of Systems Analysis of the CSSD Project.....	179
16. Number of Protected Wells and VIP Latrines Constructed by the Ministry of Health, January 1982 to December 1985.....	197
17. Expenditure by Ministry of Health on Water and Sanitation Between 1982 and 1984.....	198

18. Summary of Systems Analysis of the MOH Pilot Projects.....	200
19. Basic Needs as Perceived in the Masvingo Coordinated Rural Development Programme.....	207
20. Number of Latrines Constructed in Masvingo Province Between 1983 and 1985 by District.....	207
21. Summary of Systems Analysis of the GTZ Programme....	214
22. Summary of Systems Analysis of the UNICEF Project...	230
23. Summary of Systems Analysis of the LWF Project.....	243
24. Summary of Systems Analysis of the NORAD Crash Borehole and Long Term Programmes.....	256
25. Summary of Systems Analysis of the DANIDA Project...	266
26. Summary of Systems Analysis of the SIDA Project.....	269
27. Summary of Systems Analysis of the SCF Project.....	272
28. Summary of Evaluative Criteria for Each Case Study..	281
29. Mix of Components in Each Project.....	282
30. Roles of the Systems in Each Project.....	289
31. Summary of the Rural Water Supply and Sanitation Supra System as it Existed in Zimbabwe.....	290
32. Summary of an Idealized Supra Systems Model for Rural Water Supply and Sanitation in Zimbabwe.....	306

List of Figures

	Page
1. Diagram Showing Checkland's Soft Systems Analysis Process.....	11
2. Diagram Showing Cornock's Supra Systems Analysis Process.....	13
3. The Community Water Supply and Sanitation Sector as a System and its Environment.....	15
4. The Rural Water Supply and Sanitation Sector the Common Task Environment of Multiple Systems - a Supra System.....	17
5. Improved Water Supply and Self Help Hypothesis.....	62
6. Project Related Self Help Hypothesis.....	63
7. Paradigm of Self Help and Rural Drinking Water Schemes.....	64
8. Diagram Showing the Organization of the District Administration and the Linkages Between Local Government and Community Structures.....	91
9. Systems Diagram of the Preparation of the National Master Plan for Rural Water Supply and Sanitation...140	140
10. Systems Diagram of St.Theresa's Mission Project.....	167
11. Systems Diagram of the CSSD Project.....	181
12. Model Project Cycle as Refined by the Ministry of Health in the Pilot Projects.....	186
13. Systems Diagram of the MOH Pilot Projects.....	202
14. Systems Diagram of the GTZ Programme.....	216
15. Systems Diagram of the UNICEF Project.....	232
16. Systems Diagram of the LWF Project.....	245
17. Systems Diagram of the NORAD Crash Borehole and Long Term Programmes.....	258
18. Systems Diagram of the DANIDA Project.....	268
19. Systems Diagram of the SIDA Project.....	271
20. Systems Diagram of the SCF Project.....	274

21. Idealized Supra Systems Diagram of the Rural
Water Supply and Sanitation Sector in Zimbabwe.....308

22. Diagram Showing the Causal Hypothesis of the
Logical Framework.....331

23. An Example of a Logical Framework for a Rural
Water Supply and Sanitation Project.....332

Acronyms

AGRITEX	-	Agricultural Extension Service
ARDA	-	Agriculture & Rural Development Authority
ARDS	-	African Rural Development Study
CA	-	Communal Area
CARD	-	Coordinated Agriculture & Rural Development
CATWOE	-	Customers; actors; transformation; <u>weltanschauung</u> ; ownership and environment of a system
CBHPD	-	Crash Borehole Drilling Programme
CIDA	-	Canadian International Development Agency
CSO	-	Central Statistics Office
CSSD	-	Commission for Social Services Development
DA	-	District Administrator
DAC	-	Donor Assistance Committee
DANIDA	-	Danish International Development Agency
DDF	-	District Development Fund
EEC	-	European Economic Community
EPI	-	Expanded Programme of Immunization
FRG	-	Federal Republic of Germany
FY	-	Financial Year
GART	-	German Agricultural and Development Team
GTZ	-	<u>Deutsche Gesellschaft fuer Technische Zusammenarbeit</u> (West German bilateral aid agency for technical cooperation)
HA	-	Health Assistant
ha	-	Hectare
HI	-	Health Inspector
HQ	-	Headquarters
IDRC	-	International Development Research Centre
IDWSSD	-	International Drinking Water Supply and Sanitation Decade
ILO	-	International Labour Organization
IRC	-	International Reference Centre
IRDP	-	Integrated Rural Development Project
JAICA	-	Japanese Agency for International Cooperation and Assistance

km	-	Kilometre
LGPO	-	Local Government Promotion Officer
LWF	-	Lutheran World Federation
M	-	Million
m	-	Metre
mm	-	Millimetre
MALRS	-	Ministry of Agriculture Lands & Rural Settlements
MCDWA	-	Ministry of Community Development & Womens Affairs
MCH	-	Maternal & Child Health
MEP	-	Minimum Evaluation Procedure
MEWRD	-	Ministry of Energy, Water Resources & Development
MFEPD	-	Ministry of Finance Economic Planning & Development
MLGRUD	-	Ministry of Local Government, Rural & Urban Development
MLGTP	-	Ministry of Local Government and Town Planning
MOH	-	Ministry of Health
NAC	-	National Action Committee (of the IDWSSD)
NGO	-	Non Government Organization
NMPRWSS	-	National Master Plan for Rural Water Supply & Sanitation
NORAD	-	Norwegian Agency for International Development
ODA	-	Overseas Development Administration (the British bilateral aid agency)
OPEC	-	Oil Producing and Exporting Countries
Para	-	Paragraph
PCI	-	Practical Concepts Incorporated
PHC	-	Primary Health Care
PMD	-	Provincial Medical Director
PPU	-	Project Preparation Unit
PVC	-	Polyvinyl Chloride
ROZ	-	Republic of Zimbabwe

RWSSP	-	Rural Water Supply & Sanitation Project
SCF	-	Save the Children Fund
SIDA	-	Swedish International Development Agency
sq km	-	Square Kilometre
TAG	-	Technology Advisory Group
UDI	-	Unilateral Declaration of Independence
UNEP	-	United Nations Environmental Programme
UNICEF	-	United Nations Childrens Fund
UNDP	-	United Nations Development Programme
US\$	-	United States Dollars
VHW	-	Village Health Worker
VIDCO	-	Village Development Committee
VIP	-	Ventilated Improved Pit-latrine
VLOM	-	Village Level Operations & Maintenance (of hand pumps)
WARDCO	-	Ward Development Committee
WHO	-	World Health Organization
Z\$	-	Zimbabwean Dollars

Note: One Pound Sterling was the equivalent of
1.89 Zimbabwean Dollars in July 1985.

Definitions

In this thesis, reference is made to a number of terms and concepts, an understanding of which is essential to the analysis. These terms should be defined, at least on a preliminary basis.

i) Projects and Programmes.

The text when discussing developmental philosophy and practice, particularly when reviewing the Zimbabwean project case studies, makes reference to both projects and programmes, and we should be clear in the distinctions between the two. Projects are considered to be discrete activities usually located in one area with specific goals and objectives, whereas, programmes are thought to be much wider in scope (regional or national), and often composed of a number of individual projects, activities or interventions. When looking at projects generally, the interest is in the interrelationship of the elements or components of the project, whereas when studying programmes the process by which the programme evolved, or is implemented, is of primary interest. Often large scale national programmes have evolved from small pilot projects.

ii) A Developing Country.

In using this term, reference is made to the majority of Latin American, African and Asian countries that do not belong to the groups of western capitalist economies, the eastern communist states or the oil producing and exporting countries. While the term is a general one which obscures the reality of wide socio-economic, political, cultural and environmental variation, it also underlines a common political and economic status which these nations share at the global level. They are equally referred to as "the third world",

less-developed, underdeveloped or just poor nations. With the rise of more economically prosperous nations within this broad category, new methods of differentiation have, however, been adopted. The World Bank, for example, differentiates between low, medium and high income countries, while a special category of Newly Industrialized Countries has been used to refer to the rapidly expanding economies of countries such as South Korea.

iii) A Community.

According to the United Nations (1971), a developing country community is defined as an organic and physical entity. Members are in regular face to face contact with each other, share common values and objectives and share a basic harmony of interests and aspirations. In rural Africa the spatial and social organization of society is such that the concept of a community can be used synonymously with the concept of village. The rural village is, therefore, a unit of differentiation often used to define a community. This is because it provides a defined geographical area within which a high level of social interaction occurs while village members share common tribal, language and cultural characteristics. Indeed, one finds that community institutions in Zimbabwe are organized on a village basis. However, there is evidence that community members do not necessarily share common interests and aspirations. This issue is discussed in the case studies and is considered an important factor in explaining some of the the constraints to community participation in development.

iv) Community Participation.

The concept of community participation is frequently associated with Third World development projects (particularly rural development), by governments and aid agencies. It is also often associated with Primary Health Care Strategies and in projects associated with the Water

Decade where it has assumed a central importance (Whyte, 1984). The extremes in definitions commonly used by donor and governmental agencies range from community participation being seen as the recipient community making a labour or cash input into a specific development project, to participation being understood to mean a broader process of empowering the community to determine the development initiative themselves. In the former, community participation is restricted to implementation, while in the latter, it involves decision-making. The extent to which one or other is used depends on the policy of governments and their supporting development agencies (Oakley & Marsden, 1984.)

Community participation is thought to achieve a number of benefits ranging from the reduction of costs to government, to ensuring proper use of and maintenance of equipment, to that of achieving behavioural or attitudinal change (Bamberger, 1988). The importance of community participation as an integral part of rural development was acknowledged in 1971 by the United Nations which defined the concept as a combination of government intervention and community self-help to achieve improvements in local conditions and to contribute to national development (United Nations, 1971).

While there appears to be a consensus over the need and desirability to encourage community participation, there is not a universal definition as to what it means. However, a common denominator of most definitions is that two of the basic characteristics of community participation are that the participants must provide self-help contributions, while government and/or donors must provide technical and financial assistance. Beyond this point, definitions of community participation are ambiguous.

v) The Organization for Economic Cooperation and Development (OECD)

This economic policy coordination "club", originally

composed of the non socialist European countries, was formed following World War II. In 1961, it was expanded to include Canada, the United states, Australia, New Zealand, and Japan. At the same time a special committee, the Development Assistance Committee (DAC), was created to promote and coordinate bilateral aid programs. Many global statistics on aid programs group the "DAC countries" together (Lappe, 1980). The OECD members are: Australia, Austria, Belgium, Canada, Denmark, Finland, France, Germany, Greece, Iceland, Ireland, Italy, Japan, Luxembourg, the Netherlands, New Zealand, Norway, Portugal, Spain, Sweden, Switzerland, Turkey, the United Kingdom and the United States.

vi) Bilateral Aid.

Bilateral aid refers to transfers of goods or services from one government to another, as either grants or loans. In 1978, the total amount of official development assistance from the Organization for Economic Cooperation and Development (OECD) countries through bilateral channels was US\$13.1 billion. The total bilateral and multilateral aid from OECD countries was US\$18.8 billion. The total concessional assistance from the OPEC countries amounted to US\$3.7 billion in 1978, most of which was bilateral aid from Saudi Arabia and the United Arab Emirates (Lappe, 1980).

vii) Multilateral Aid.

Multilateral aid is a transfer of goods or services from one government to another through an intermediary organization (controlled at least nominally by more than one government, hence "multilateral"). The principal intermediary agencies involved in multilateral aid are the World Bank and the various regional international financial agencies (the Inter-American, African and Asian Development Banks), the Witteveen Facility of the International

Monetary Fund, and the various development organizations of the United Nations such as the United Nations Development Programme and, the World Food Programme, as well as the International Fund for Agricultural Development established by the 1974 World Food Conference.

Other multilateral aid institutions, namely the OPEC (Organization of Petroleum Exporting Countries) Special Fund, the Arab Fund for Economic and Social Development, and the Islamic Development Bank, have been established by the oil exporting countries. OPEC constitutes a significant source of concessionary finance, with disbursements of US\$2.8 billion in 1978, compared to US\$18.8 billion from the OECD countries. The level of OPEC aid has dropped from US\$5.37 billion in 1976, largely reflecting the major cutback in OPEC aid flows to Egypt. Of the total US\$18.8 billion in official development assistance in 1978, US\$13.1 was in bilateral aid and US\$5.7 billion in multilateral aid (Lappe, 1980). Multilateral aid, which consists mainly of loans, usually on varied concessionary terms (other than the UN development agencies family programmes), contrasts with bilateral aid which is generally a mix of grants and loans.

The term multilateral aid is not used to refer to government aid through private voluntary organizations.

viii) Vertical Programme

A vertical programme can be described as an activity undertaken by a structured body or institution within which the normative and prospective planning decisions are taken by either the highest authority and passed vertically downwards to the lower levels for implementation, or conversely where decisions are taken at the lowest level and passed vertically upwards for approval and funding. Typically in developing countries the apex of this structure would be a central government body or ministry. The hierarchy would also have a decentralized

administrative middle layer at regional or district level and at the bottom the community.

The term vertical programme is often used in a derogatory sense and commonly used to mean a "top-down" approach to planning which is thought by many to be inappropriate for community based development projects. It is in this sense that the term is used in this thesis. It should also be noted that many aid agencies feel that a "bottom-up" approach should be the cornerstone to development project planning. However, it is clear to others that planning is an iterative process with information flows that move both upwards and downwards and also laterally (Lincklaen-Arriens & Hessing, 1982).

ix) Non Government Organizations (NGOs)

NGOs are independent, non profit making, tax exempt, non governmental organizations, governed by private citizens, whose purpose is to engage in voluntary, charitable relief and development assistance. Amongst the NGOs are foundations, religious organizations and other non profit making groups. NGO organizations can be found in both the developed and developing countries. Overseas or foreign aid from developed country NGOs is given in the form of commodities, project support and technical assistance to both Third World government and non government recipients, often local NGOs. Over the past twenty years there has been a rapid expansion of the amounts of aid channelled through the NGO community. From the mid 1960's to 1980 the levels of aid almost trebled to some US\$2,000 million, which represents 9% of all public and private aid from the OECD countries. Of this two thirds is generated from private contributions and the remainder from government grants and other gifts. The largest contributors to NGO aid programmes are from the United States, the United Kingdom, West Germany, Canada, Sweden and the Netherlands (Lappe, 1980). However, an increasing number of multilateral and bilateral aid agencies are

disbursing their funds through NGOs, such as, The European Development Fund, UNDP and the Nordic donors.

x) Sanitation

Throughout this thesis the term "sanitation" or "low cost sanitation" is used in a narrow sense to mean the provision of facilities for the safe and hygienic disposal of human excreta in order to isolate it from the physical environment, thereby, breaking the vectors of disease transmission. In Zimbabwe, the term has become synonymous with the Blair Latrine (a ventilated improved pit latrine), which is described in some detail in the text.

xi) Sector

The term sector when used in the development aid context is taken to mean discrete areas of activity within, or components of, a donors aid programme. The sector divisions commonly adopted by most bilateral and multilateral donors are; population and health, water and sanitation, energy, agriculture, education, industry, and roads and transport. These divisions conveniently correspond to the administrative structure of most developing countries. A number of these sectors are divided in to rural and urban sub sectors, for example water and roads and transport. Throughout this thesis the term sector is loosely used to mean the rural water and sanitation sub sector, or is used in connection with the other aid/activity categories listed above. An exception to this is when the term is used to differentiate between activities undertaken by private entrepreneurs as opposed to governmental institutions, that is, the private sector and the public sector.

Missing definition of sector

Map Showing Zimbabwe.

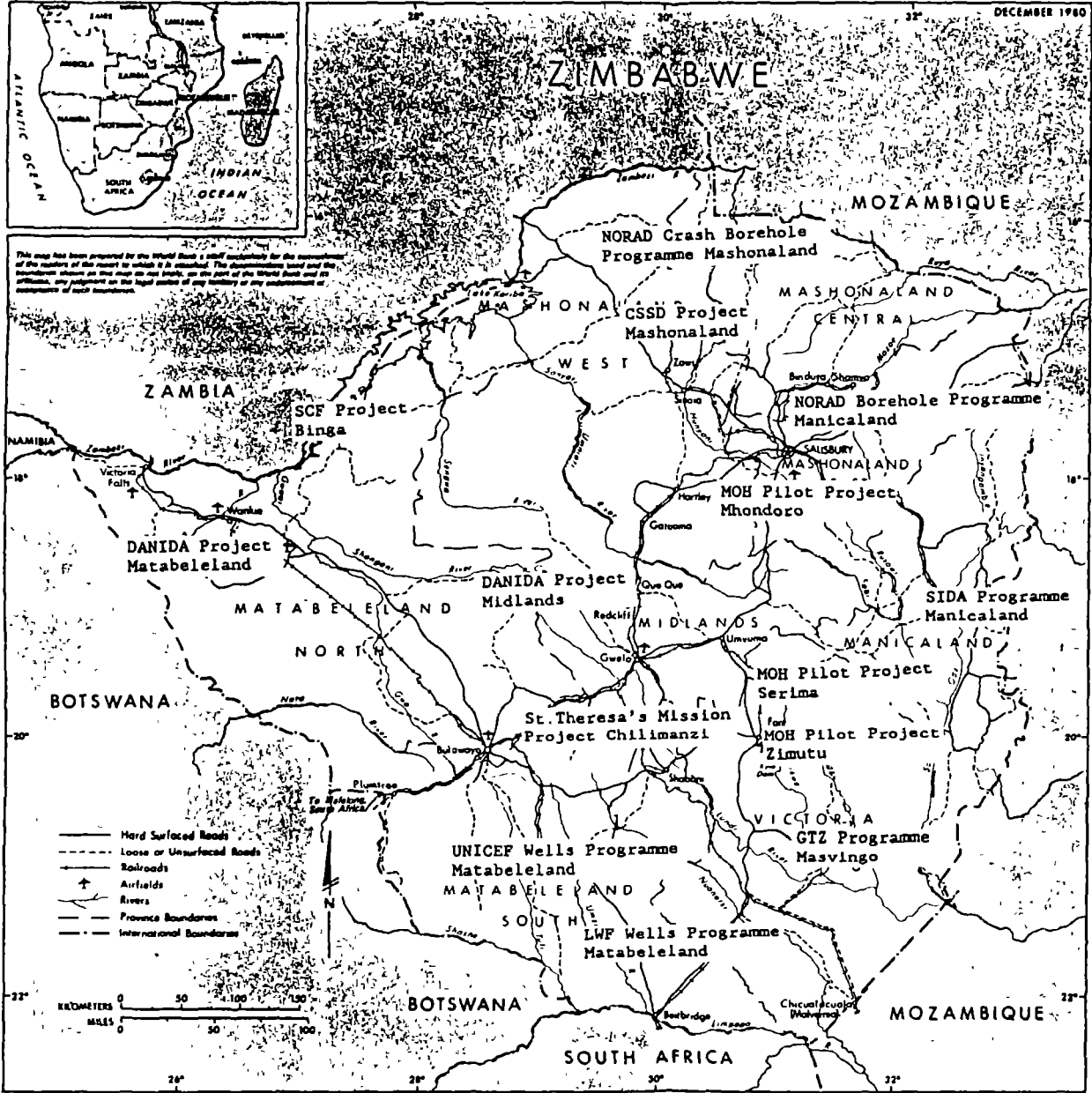

- o 0 o -

Chapter 1

The International Drinking Water Supply
and Sanitation Decade

and

Systems Analysis

- o 0 o -



Chapter 1

The International Drinking Water Supply and Sanitation Decade and Systems Analysis.

1.1 Problem Statement

One of the areas of emphasis in current Third World development programmes is the rural water supply and sanitation sector, particularly since the launch of the International Drinking Water Supply and Sanitation Decade (IDWSSD), which is sponsored by the United Nations Development Programme (UNDP). At the United Nations Water Conference at Mar del Plata in 1977, a strategy for developing countries to adopt realistic standards of water quality and quantity in order to provide water and sanitation for all by the year 1990 was affirmed, "the Decade Approach". The conference also recommended that, "each country should develop national plans and programmes for community water supply and sanitation giving priority to segments of the population in greatest need". It was also stated that this fundamental challenge facing all mankind could only be met with full international cooperation.

By 1985, the end of the first half of the Decade, some 500 million additional people had gained reasonable access to safe drinking water and 80 million to adequate sanitation. Although these statistics are impressive, this left a shortfall of 1,200 million people without safe water and 1,900 million without sanitation (UN, 1985). Despite the tremendous interest that has been generated in developing country governments and aid agencies, and the additional sector investments that have been mobilized by the Decade Approach, in terms of numbers of people served, it seems unlikely that the provision of water supplies has

kept pace with population increase (sanitation certainly has not), and unless a rapid acceleration in the pace of development takes place, or a reduction of fertility occurs, the Decade or even two decades will not achieve its goal. Also, it is becoming apparent that of many water and sanitation schemes that have been constructed, a high percentage have fallen into disuse or disrepair because of lack of maintenance or neglect by the communities that use them, even though many of these schemes were supposedly built with community participation and self help. These massive investments of labour and capital have failed to achieve the health and socio economic benefits they were designed to capture (Ferrant, 1985. WHO, 1988).

The constraints on accelerating water supply and sanitation sector development that were identified at the start of the International Drinking Water Supply and Sanitation Decade in 1980 included, ⁽¹⁾ inadequate funding, ⁽²⁾ lack of operations and maintenance of facilities, ⁽³⁾ lack of trained personnel, ⁽⁴⁾ non involvement of the recipients, ⁽⁵⁾ unacceptability of technology and poor logistics support (Bourne, 1985). Five years later, at the Decade mid point, it was felt that these constraints had not been removed and were still the major hindrance to accelerating the provision of services to low income groups. Indeed a ⁽⁶⁾ further constraint was added to the list - inadequate cost recovery. Also, other major constraints that were beyond the direct and immediate control of governments were ⁽⁷⁾ identified, these included; economic recession, ⁽⁸⁾ drought, ⁽⁹⁾ famine, and ⁽¹⁰⁾ high population increase (UN, 1985. WHO, 1988).

A number of explanations for these disappointing results have been offered by the UN, WHO, and other donor agencies. The most significant of these were discussed in the Water and Sanitation Decade Mid Term Review Report presented to the UN General Assembly in 1985 (UN, 1985. WHO, 1988), these explanations were presented as a list of ⁽¹¹⁾ constraints categorized as socio cultural, institutional and financial.

It was felt that, socio cultural constraints have

presented the most serious barriers to the achievement of the Decade's goals, that is; water and sanitation development projects have often failed to take into account socio cultural considerations, and planners have been surprised when projects have either failed to be completed, or have been abandoned by the intended beneficiaries. Socio cultural considerations were recognized to be important with reference to achieving behavioural changes in relation to household hygiene, excreta disposal and water use; assessing the socio economic capacity and willingness of the recipients to make self-help contribution to the implementation of the project; ensuring that the technology and wider goals of projects are acceptable to and supported by the community.

It was also felt that increased attention should be paid to problems relating to the administrative, planning and implementation capacity of developing countries, and the need for human resource development, particularly, manpower training at central government and local government levels. It is persistently stated in the literature that inadequate manpower both in skills and absolute numbers at national, local government and community level represents one of the greatest constraints to the achievement of Decade aims.

Financial issues were seen as the third major group of problems constraining the achievement of Decade goals. These were identified at two levels; insufficient capital funding from domestic and donor sources, and lack of finance or credit at the village or community level particularly for operations and maintenance.

1.2 Hypothesis

Although the UN and WHO statements regarding constraints on accelerating the development of the water supply and sanitation sector are valid, it is observed that the donors themselves, the design of the projects they sponsor and the complexities of the recipient governments

have not been adequately scrutinized. It is contended that there are a number of additional constraints to achieving the goals of the Decade that are rarely discussed, and that must be added to the UN list. Four are discussed here.

I Firstly, the long time period required. In order to improve the water and sanitation sector in a developing country, a developmental process has to be initiated that progresses from a small scale activity or pilot scheme to national programme. This process is little understood or acknowledged by project designers, and probably has a longer time scale than the Decade itself.

II Secondly, donor bias and pressure. It is contended that a major constraint to the IDWSSD reaching its goals, particularly in rural areas, has been its single minded promotion by some donors and organizations, which when combined with the donors own philosophy, political pressures and biases, has resulted in the implementation of poorly designed vertical projects which confound presently accepted strategies of rural development, particularly with regard to involving communities and people. Most donors are the subject of tremendous domestic political pressure, and some have seized upon the Water Decade as a means of accelerating the disbursement of overly large aid budgets. A number of donors also cling to a patronizing and misguided view of a "welfare" approach to development that does not foster the internal sustainability of projects, nor does it assist governments or communities to evolve their own independent solutions to developmental needs.

III Thirdly, overlapping responsibility and lack of coordination in developing country institutions. It is observed that the multiplicity of institutions and agencies involved in the sector, which when coupled with structures that are inappropriate for local level planning and involving communities, alternative goals and priorities, and professional biases, form a major constraint to sector development (Agarwala, 1984).

IV Fourthly, poor project design. It is observed that researchers and project designers, because of their

professional biases, have become obsessed by individual project components and have failed to see or develop the potentially beneficial linkages with other developmental initiatives such as health or agriculture. The IDWSSD has attracted and stimulated the interest of professionals and academics in various fields ranging from engineering to the social sciences. This is reflected in the proliferation of water and sanitation publications since 1980. A Review of this array of literature by the International Reference Centre in 1982 (Lincklaen-Arriens & Hessing), confirmed that the majority of intellectual thought and research has been directed towards specific project components such as the design of water supply technology or community mobilization. It also reveals that relatively little research has been directed towards the inter-relationship of these individual components within a project, or to the process of sector development within a country. Most apparent is the dearth of literature on the relationship of water and sanitation to the development of rural areas. Indeed in order to find literature on coordinated or integrated rural development one has to turn to other sectors particularly agriculture.

The external influences of the donor's policy and pressures, and the specific and narrow research with its resulting publications, has reinforced the verticality of the Decade programme. Project designers like to believe that rural water supply and sanitation projects are composed of a number of discrete and identifiable components. These individual components, for example; community participation, appropriate technology, social feasibility studies et cetera are assembled like building blocks in presently accepted design practice that does not take into consideration the need to link these components in a dynamic process in which the interaction and relative importance of these components changes over time. Also, at a higher level, project designers have failed to link specific projects into a broader dynamic process of sector

5006
23/10/82

Important
to read

45

development. Lincklaen-Arriens and Hessing state (1982, p63) that.

"Insufficient attention has so far been given to the study of inter and intra sectoral relationships, and that present knowledge of sector components leaves us with a static image of the sector structure. The relationship that exists between the components, and between the components and the environment constitute the infrastructure of the sector. These relationships and the actual interactions, that is; the dynamics of the sector development process, better reflect the sector's functioning or mal functioning".

It is also observed that many designers fail to consider the internal logic of their project proposals. For example, can the planned goals be achieved given the limitations of the resources being provided? (Bejard et al, 1981. PCI, 1969).

It is further contended that apart from the constraints discussed above, there are a number of essential elements that contribute to successful projects and the development process that have not been recognized or given due weight. First, the need for single minded and visionary individual to lead and drive a project to a successful conclusion. Second, the involvement of the private sector or other groups outside the bi and multilateral donor government axis, notably non government Organizations (NGOs), who may be able to play an intermediary role (Briscoe & de Farranti, 1988). Third, it is also believed that rural water supply and sanitation (RWSS) projects are probably most successful when they are part of a broader and sequential approach to, or process of rural development. Projects must be set at an appropriate time and place in the development process, that is, a surplus must be available within communities for investment in services, or equally communities must have a capacity to work cooperatively. Successes may also be related to the integration of water and sanitation activities into other

sectors such as health or agriculture. Conversely, the least successful projects in terms of sustainability or replicability are, in the main, those which are free standing, unrelated to other sectors, and managed centrally, which is most often the case. Perhaps an exception to the above is that when first introducing community based RWSS concepts into a country there may then be a need to single out the initial projects to create awareness and political commitment in a free-standing pilot phase (Rondinelli, 1983). This thesis will attempt to illustrate the contentions outlined above through an analysis of the development of the rural water supply and sanitation sector in Zimbabwe between 1974 and 1987 using a systems analysis approach. The discussion focusses in particular on a comparative evaluation of a number of rural water supply and sanitation projects that were milestones in the development of the sector, and which reflect project design practice and donor influence.

The reasons cited by the UN and WHO and other donors for the failure of the IDWSSD to achieve its goals and objectives - lack of operations and maintenance, lack of funding, lack of recipient involvement, lack of trained personnel, unacceptable technology and poor logistics support are inadequate generalizations because they represent the perspective of the donors, and assume that apart from funding all the constraints lie within the ambit of the recipients - the developing country governments and their resident communities. The definition of the problem and citing of reasons for failure by only one of the interest groups clearly affects the perception of the problem and its solution. Many of the constraints listed above are a result of ill conceived aid programmes or projects and an excess of aid funds that often overwhelms the capacity of many developing countries (Bowden, 1979). The donors are in effect blaming the victims. For example, lack of operations and maintenance, and trained personnel often reflects aid projects that have concentrated on capital expenditure and have failed to build institutional capacity. Similarly, lack of community

participation reflects centrally designed vertical projects in which donors and governments have failed to establish decentralized structures capable of communicating with people. Also, unacceptable technologies may reflect projects that are used as conduits to distribute inappropriate western technology to the markets of the Third World. Clearly the problems discussed above are a complex web of issues that are difficult to understand without a technique or framework for analysis. Systems analysis provides such a framework within which the relationship between inter-linked groups with a common interest or goal can be examined. Although systems analysis has not been rigorously applied to the IDWSSD or to the domestic water supply sector in the past, it provides an appropriate approach for reviewing the "Water Decade" as it concerns itself equally with all its constituents.

The rural water supply and sanitation sector can be conceptualized as a complex reality comprising of a number of interacting organizations or systems having commonality and conflict in their goals. The three systems that exist are government, donors and the community. The analysis of the development of rural water supply and sanitation in a specific country can be carried out at two levels. At a higher level the three systems that constitute the sector and their interaction can be examined. Whereas, at a lower level a detailed analysis of sector development projects that are the joint product of these systems can be undertaken. Project case studies are useful for detailed examination of project design, and the socio political and administrative structures through which they are implemented, this is discussed in chapter 7. At this point we should consider in some depth the concept of the rural water supply and sanitation sector as interacting systems.

1.3 A Systems Approach to Rural Water Supply and Sanitation Sector Analysis

The study of work and its environment has taken two

forms. Firstly, a macro perspective that considers an organization as the unit of analysis. It is concerned with organizational structure and goals, the technologies used and how the institution influences or is influenced by its environment. This discipline is named organization theory. Secondly, a micro perspective that considers the human being as the point of study. It is concerned with each individual's psychological make-up, and with other individual and group variables that determine how a person will act in given situations. Questions such as how a person learns or is motivated, and what are good leadership and management strategies, are addressed in this micro view. This discipline is called organizational behaviour (Jackson et al, 1986). Both of these disciplines are particularly relevant to this thesis, as rural water supply and sanitation activities in developing countries are promoted by three organizations, namely, donors, governments and communities, whereas actual projects are designed and managed by individuals within these organizations.

These are no organizations

An important analytical tool in organizational theory is systems analysis. Actual situations and dynamic processes can be considered as a system where a collection of elements can be distinguished that have a relationship with each other and with the surrounding environment. The environment may be considered as the world of a system, the system and the environment being interactive. Elements are the smallest parts of the system being considered. Their behaviour is studied but not their structure. In complex systems closely related elements may be grouped together as components. Elements and components are "black boxes" with inputs, throughputs and outputs (Doorn et al., 1978). Relationships between components, and between components and the environment can be defined as either internal or external. A systems approach to analysis and planning provides planners with an abstraction from reality which simplifies understanding, management and forecasting. It also helps to ensure that important elements of the system

myself

are not forgotten because of the inventory-taking nature of the process. An important concept in organization theory is that an organization can be considered as a system.

The science of systems analysis has developed and bifurcated from the initial more general applications of systems thinking in the solution of complex real world problems. One branch involves the development of "hard systems" methodologies which are used by engineers and similar disciplines for the solution of functional problems such as complex manufacturing processes. In the other branch, "soft systems" analysis methodologies are developed. These provide a useful tool for understanding complex unstructured problems in human activity in which the goals are not clearly defined (Cummings, 1980). Soft systems analysis, which is particularly appropriate to the issues addressed in this thesis is discussed in some depth.

* Checkland (1981), who is one of the leaders in soft systems analysis, has developed a seven stage approach to the analysis of a problem. In its basic form this consists of the following. First, providing a rich, but not necessarily structured description of the problem. Second, expressing or defining the problem situation. Third, providing root definitions of the system. Fourth, developing a conceptual model of the system. Fifth, comparing the conceptual model in four, with the real situation in two. Sixth, determining desirable and feasible changes to the situation, and seven, taking action to improve the problem (Checkland, 1981). This methodology is shown diagrammatically in figure 1. As will be noted steps three and four are systems abstractions, whereas, the other steps are within the context of the real world.

Cornock (1977) has modified Checkland's methodology for use in "supra-institutional problem situations", that is, where problems are not owned within one organization, as is the case in the rural water and sanitation sector. The seven steps are modified to the following. First, the supra-institutional problem situation is perceived. Second, the problem situation is expressed as a set of tacit models

* Some confusion here: system analysis
 problem analysis vs. the system approach

should come first

unclear lump for the unimportant

Figure 1. Diagram Showing Checkland's Soft Systems Analysis Process (from Checkland, 1981).

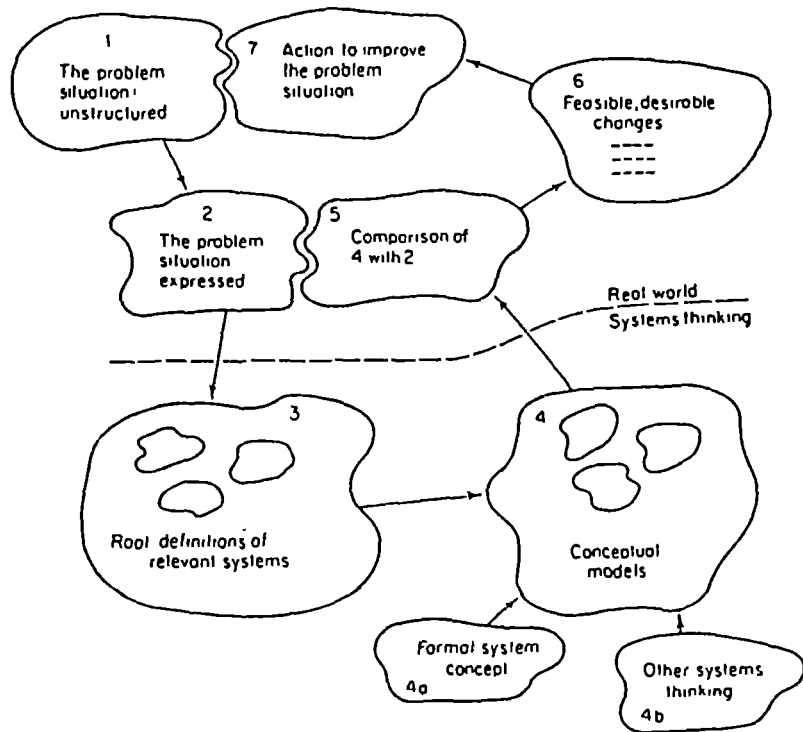

Handwritten notes:
system
to be
made

imputed to actors, and these tacit models are interpreted with reference to the particular sector (or problem situation) described in one. Third, root definitions of the multiple systems are provided. The fourth step involves the construction of aggregate conceptual models of the systems. Fifth, the development of a second level conceptual model as a public basis for intervention in a sector. Sixth, debate over the planned intervention. Seven, implementation of the agreed interventions. Cornock's modified methodology is shown in figure 2. As will be noted steps two, three and four are systems abstractions, whereas, the other steps are in the context of the real world.

In both methodologies a crucial stage is defining the root definition of the systems being considered. Checkland has coined the ^{gehörigen wissenschaftlichen / akademischen} mnemonic CATWOE as an aid to remembering the six characteristics of a system which are. C - customers or beneficiaries; A - the actors; T - the transformation process of converting inputs to output; W - Weltanschauung or image which makes the root definition meaningful; O - ownership of a system - that is the agency that has prime concern and the ultimate power to cause a system to cease or exist; and E - the environmental constraints of a system or the wider system that has to be taken as a given. Root definitions of a system can be issue based which is of value to the investigators of specific problems or primary task based.

The criticisms of soft systems analysis are summarized as follows. Prevost (1976), argues that it is located in the structural - functional tradition of sociology and as such has a static and conservative bias and is unable to cope with change and conflict. Jones (1978), suggests the methodology is akin to constructing an ad hoc theory about the problem situation which is derived neither from general theory or scientific testing but from a preformed set of concepts developed from experience. These arguments are rebutted by Checkland (1981), and others (Bryer, 1977. Naughton, 1977), who point out that the analysis is a learning process in which the emphasis is on the process of

Figure 2. Diagram Showing Cornock's Supra Systems Analysis Process (from Checkland, 1981).

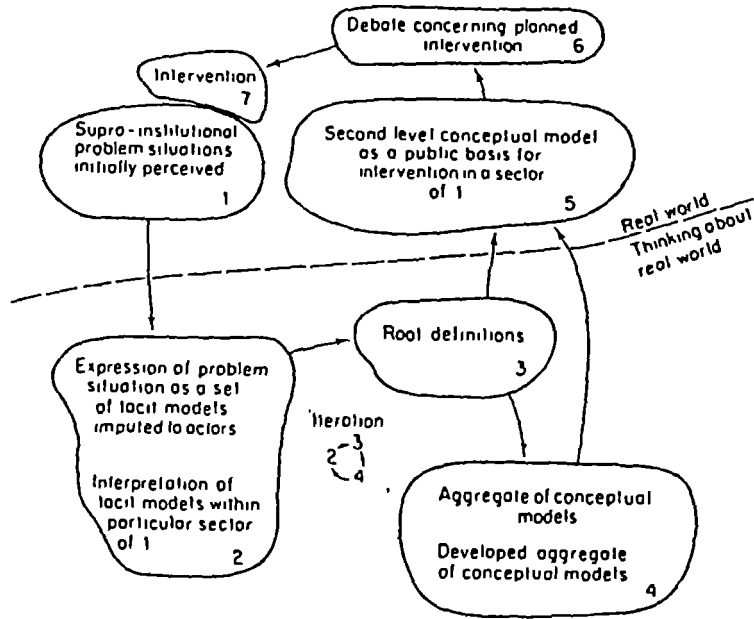

inquiry rather than on the properties of the object being studied.

A broad literature search revealed that only Lincklaen-Arriens and Hessing (1982) have attempted to apply organization theory and systems analysis to the rural water supply and sanitation sector. They define the sector as a system with the following components; planning, institutions, legislation, finances, manpower, technology, community participation and information. They then define the environment of the sector as being sub divided into functional categories including; socio-cultural, economic, physical, institutional and environmental. The system is further characterized as being open and dynamic, implying that the relationship between the components and the environment vary over time. The rural water supply and sanitation system is visualised as two concentric circles revolving independently as shown in figure 3. This model of the sector as a system is completed by defining its inputs, throughputs and outputs, and by examining its environment more closely. Inputs are seen as the resources of the sector, that is; knowledge, information, investments, equipment and trained people. Interventions and management such as projects and programmes form the throughput, whereas the outputs are seen in terms of health and socio-economic improvements. Intermediate products or benchmarks are defined as water systems constructed, functioning projects and trained people.

fits description of system in para 9

different levels systems

The model presented by Lincklaen-Arriens and Hessing is a generalization that is inadequate for the analysis of a reality as complex as that of rural water supply and sanitation sector in a developing country because it fails to define the problem areas or recognize the differing interests of the various actors involved. A more useful approach to the analysis would be to consider the sector as a common task environment of the multiple systems or institutions involved, that is; donors, government and communities. Each of the individual institutions should be considered as a system in its own right whose inputs are

B

Figure 3. The Community Water Supply and Sanitation Sector as a System and its Environment (from Lincklaen-Arriens & Herding, 1982).

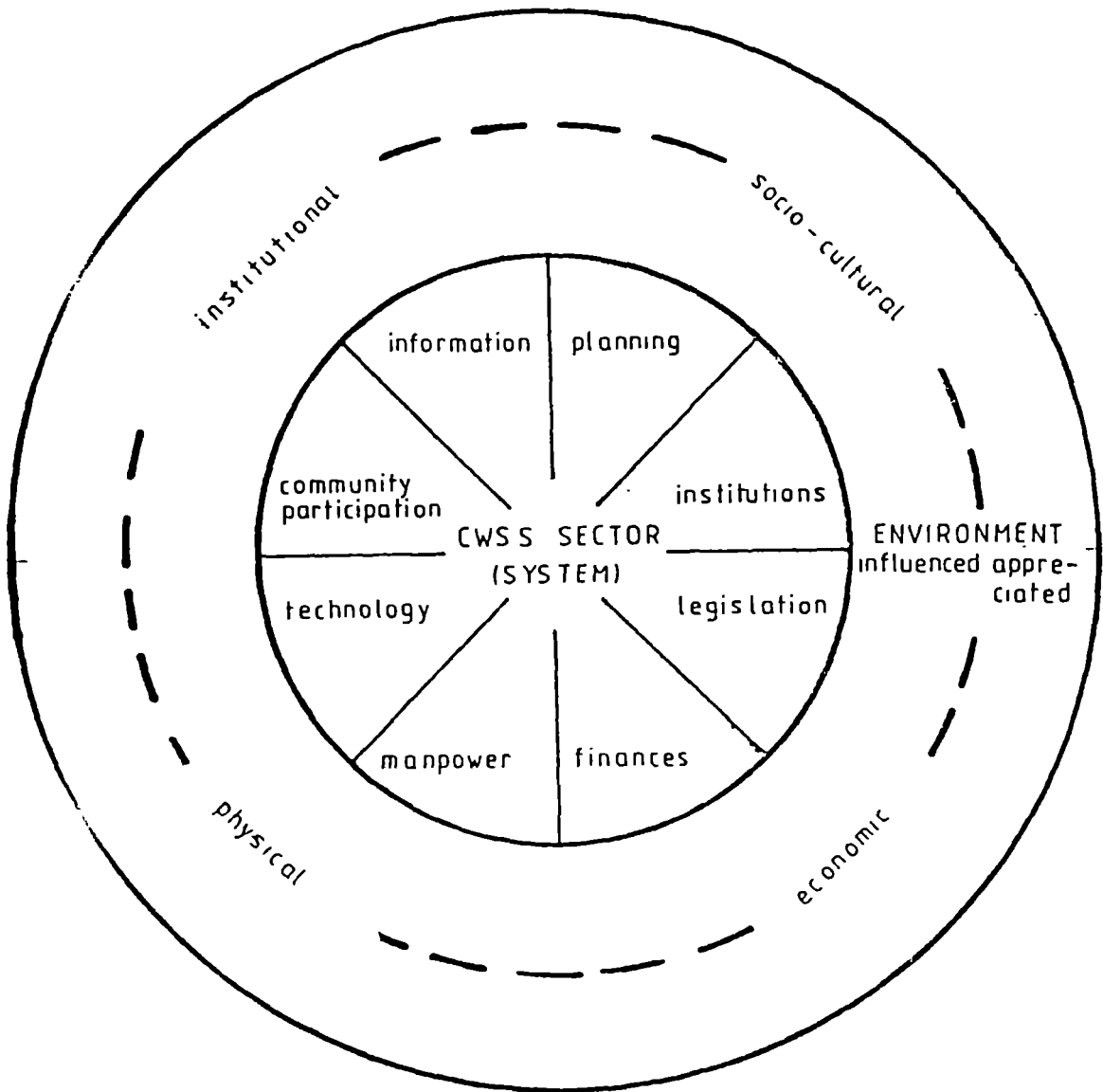

resources, and outputs are projects that have components such as technology and delivery mechanisms. All of this is set within a general environment as depicted in figure 4.

In the analysis of the functioning of such a reality or "supra-system" the first question to ask is, what systems and sub-systems exist, and how are they structured? For each system, that is, who are the owners, who are the actors, who are the customers, what is the transformation process and what is the image (Checkland, 1981)? The second question is, how do these systems behave? How are problems defined and solutions formulated by the individuals within these systems? Are these decisions governed by self interest and traditional practices, and are they made by special groups? Are explanations for success and failures of projects that are commonly voiced dominated by desires to take credit for successes and avoid blame for failures? Are barriers erected by elitist groups so that others are excluded from the decision making process, or is professional training so narrow that the experts are unable to comprehend broader issues? Who are the leaders, and to whom are they accountable (Goodman & Love, 1979)?

When analyzing the planning, design and execution of projects which are the outputs of these multiple systems the pertinent questions to ask are related to inter-systems behaviour. How do these systems interact, and what are the constraints on interaction? How permeable are their boundaries, and are boundary spanning devices or structures in place? These are particularly pertinent to issues of coordination and communications between ministries, and between governments and donors.

The general environment of the water sector is dynamic and uncertain and it can be considered at two levels. At a global level there are the effects of "broad-brush" donor policies and development aid trends, such as the IDWSSD, and the move towards structural adjustment lending, together with other macro-economic and political changes (Feinberg et al., 1986). At national or country level the sectors environment consists of factors such as a

Figure 4. The Rural Water Supply and Sanitation Sector as the Common Task Environment of Multiple Systems - A Supra System.

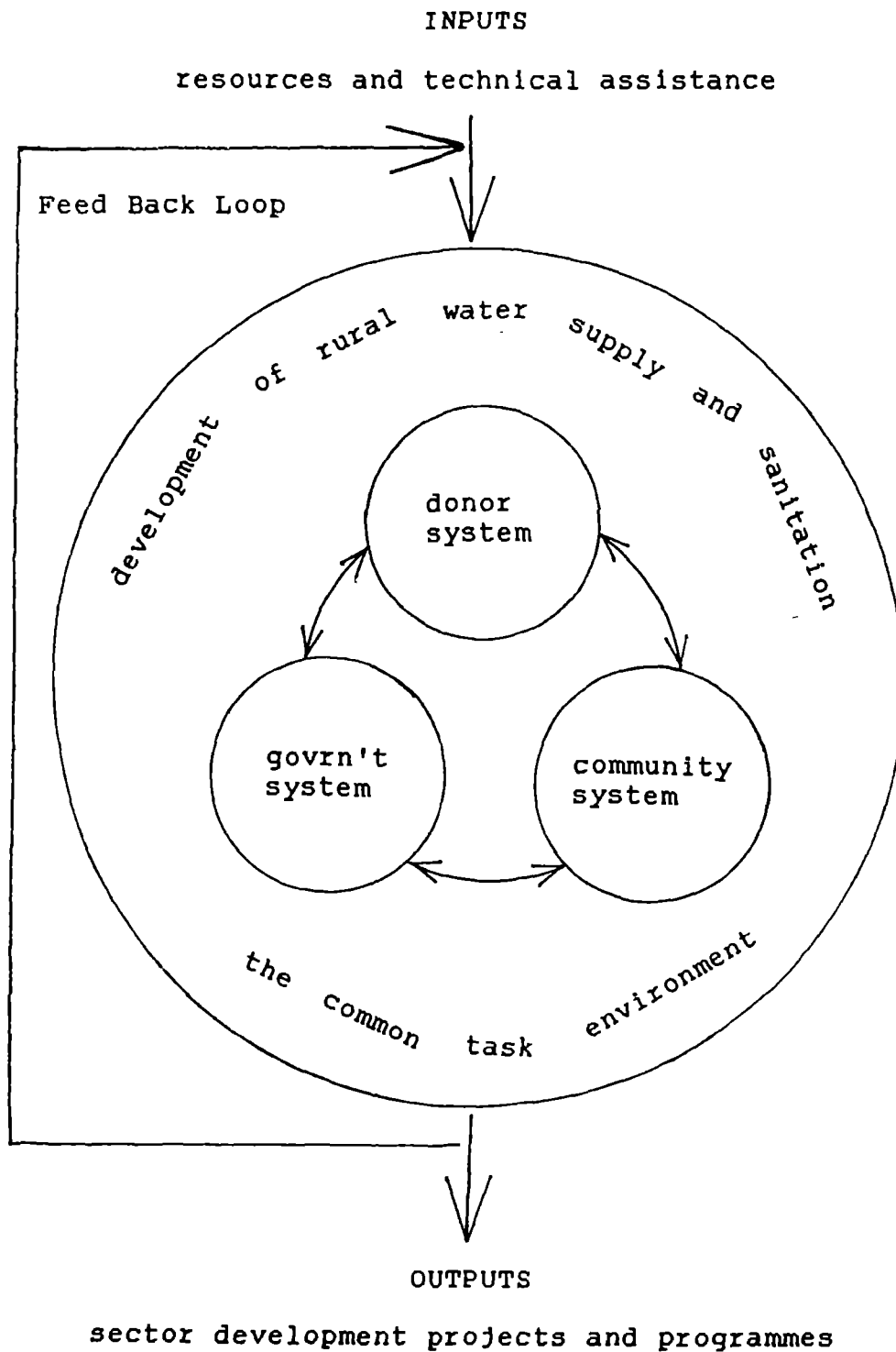

government's policies and a donor's reaction to these, and vice versa; climatic conditions; the availability of domestic capital funds et cetera.

This thesis attempts an alternative study of the water and sanitation sector to that of Lincklean-Arriens and Hessing using a soft systems analysis and case study approach which follows Cornock's process. Having defined the supra-institutional problem situation as initially perceived in the opening hypothesis, the next step is to define the systems in which we have interest. In this case these are; donors, developing country governments and communities. Table 1 list initial root definitions of these three systems using Checkland's CATWOE classification of characteristics. These definitions will be modified later. Although the CATWOE characteristics do not include a systems efficiency, it is implicit in Checkland's analytical process that criteria for judging the efficiency of a system should be established.

Other steps in the process involve describing these systems as they exist in a real life situation in order to modify their root definitions, and to examine their interactions in the endeavor to transform inputs into outputs. This will be done through a case study of donor supported rural water supply and sanitation development projects within a developing country in which communities were involved to some degree. The role of the systems in these case studies is contrasted with a conceptual systems model of rural water supply and sanitation sector development which is derived from contemporary thinking on water sector and rural development project design in order to determine effective interventions and strategies that can be utilized in solving real life problems.

Checkland points out that the systems analysis process is circular and iterative and as such the point of departure is not critical as long as the end result is a comparison of the conceptual system model with the real life situation. Section 1.6⁵ of this chapter, "Thesis Structure" sets out in some detail the sequence adopted in this study.

Table 1.

Initial Systems Root Definition Using CATWOE
Characteristics

Definitions	Donor	Government	Community
Customers/ Beneficiaries	Developing countries	Local bodies Communities	Individuals
Actors	Bilaterals Multilaterals NGOs Experts Consultants Researchers Private Sector	Ministries Local govt Govt officers Extn workers Politicians	Elect bodies Trad leaders Individuals Politicians Entrepreneurs
Transformation Process	Finance & tech resource transfer	Conversion of resources to infrastructure & education	Utilizing infra structure & education to capture benefit
Weltanschauug (image)	Supporters of 3rd World development	Body managing & admining devl country	Underprivged people & aid targets
Ownership/ 12000000 000	United Nations 1st World Govt	Dictators/ Parliament Bureaucrats	Trad leaders Politicians Elect bodies
Environment	Aid Policy/ trends. Geo- political & macro economic issues	Extnal economic & political relations. Intnal finance & politic issues	Local social & environmental issues

1.4 Zimbabwe as a Case Study

Zimbabwe is a particularly interesting case for the study of the various points raised in the hypothesis. Situated in south/central Africa it is a middle income group country (GNP OF US\$680) approximately the size of Spain. It has a population of some eight million, of which 73% are rural and an infant mortality rate of 77 per 1,000, in comparison with the United Kingdom which has 9 per 1,000 (World Bank, 1987). After gaining Independence in 1980, Zimbabwe became the new darling of the donors and its development assistance budget rose from US\$13 million in 1979 to US\$237 million in 1985 (World Bank, 1987), much of this being in technical assistance. One of the first commitments made by the new administration was to relieve the inherited urban - rural disparity through programmes such as rural development and primary health care (ROZ, 1981). Zimbabwe also made a commitment to the aims and goals of the Water Decade, and a National Master Plan for Rural Water Supply and Sanitation was prepared with external funding and major technical assistance. A range of donors and NGOs have actively supported the development of the rural water sector and Zimbabwe has been cited as one of the Water Decade success stories in Africa (UN, 1985). However, sector development started well before Independence, with two small non-government organizations (NGOs) playing an important role in this process. The post-Independence donors with their varying policies and approaches have had both positive and negative impacts on the continuation of the development cycle. Zimbabwe provides a unique opportunity to analyze sector development, the design and approach of different projects, and the role and interaction of the Government, donors and people.

1.5 Thesis Structure

The thesis is structured in four parts, part 1

comprises chapters 1, 2 and 3. This chapter has outlined the problem of poor acceleration in the provision of water and sanitation in rural areas of developing countries despite the IDWSSD, and provides an alternative hypothesis to the explanations provided by the UN and WHO. It has presented an analytical framework using "soft systems analysis" that defines the rural water supply and sanitation sector as a supra system and the common task environment of donor, government and community systems. The relevance of Zimbabwe as a case in point for the study of issues related to donors and foreign aid, the response of recipient governments, community involvement and the resulting development projects is also discussed. Chapter 2 reviews the donor system. It describes the development of foreign aid since the 1950's, present aid trends and related issues, and the origins of the International Drinking Water Supply and Sanitation Decade. Chapter 3 reviews the evolution of rural development project design since the early 1950's which was dictated by evolving aid philosophy. This is contrasted with the parallel evolution in the approach towards the design of rural water supply and sanitation projects. The chapter goes on to review present development research trends in the water sector. In conclusion a hybrid conceptual systems model for the interaction of donors, governments and communities in rural water supply and sanitation projects within a broad rural development context is proposed.

Part 2, which comprises chapters 4 to 6, describes the rural water supply and sanitation sector, or common task environment, and the donor, Government and community systems in Zimbabwe. Chapter 4 provides a general description of the geography, and post Independence political structure of Zimbabwe. This leads into a more detailed review of the socio-political and administrative structures of the rural areas. The chapter continues by describing land distribution, and perceived development needs and constraints. It elaborates on the Zimbabwe Government's post-Independence rural development policies

including; the Reconstruction, Resettlements, and the Growth Centres Programmes. In conclusion the chapter describes the extensive extension programme being established in support of these developmental initiatives. Chapter 5 reviews the institutional structure, and the current status of the water and sanitation sector. It lists, and describes the responsibilities of the numerous ministries, and other actors that are involved in the sector; water and sanitation coverage and service levels in rural areas; the development of appropriate technology development in Zimbabwe and its impact on the sector; the institutional response to the IDWSSD. Chapter 6 describes the events leading up to, and the preparation of a National Master Plan for Rural Water Supply and Sanitation, funded by Norwegian bilateral aid agency NORAD, and undertaken by a Norwegian consulting engineering company. It continues by describing the development of the NORAD aid programme in the sector.

Part 3, which comprises chapters 7 to 15, describes the methodology for, and the findings of a series of water and sanitation project case studies that are used to examine the interaction between the donor, Government and community systems. Chapter 7 reviews the choice of projects to be studied. It also defines the purpose and limitations of evaluation, and then goes on to describe the methodologies used in the analysis of both the individual projects, and the sector development process that took place during the study period. Chapters 8 to 15 describe the individual case studies in chronological order.

Part 4, which comprises chapters 16 and 17, discusses the findings of the case studies and relates them to the conceptual systems model and the hypothesis presented earlier. It then makes recommendations on project design and the direction of future aid programmes. Chapter 16 which summarizes the findings and results of the analysis of the project case studies is structured in two parts. First, a review of the sector development process that took place, and second, a review of the project designs and

implementation, and the respective roles of the donors, Government and other involved groups. Chapter 17 concludes the thesis by reviewing the original hypothesis in light of the findings, and modifies the model for rural water supply sector development and project design. It makes specific recommendations on the potential roles of developing country governments, donors and communities in this process. It also comments on "water master planning", and the future of the International Drinking Water and Sanitation Decade and the need for further research. Four annexes are attached that describe the analytical tools, and survey protocols used in the case study construction.

The data used in the preparation of this thesis was obtained from a number of sources, including; literature, Government and donor documents and reports, project reports and evaluations, interviews with donor and Government officials, field studies, and the personal experiences of the author who served as a member of the NMPRWSS planning team and as a sector adviser to the Zimbabwe Government.



- o 0 o -

Chapter 2

Foreign Aid - Trends and Issues
and
The Origins of the International Drinking Water
Supply and Sanitation Decade.

- o 0 o -



Chapter 2

Foreign Aid - Trends and Issues.

and

The Origins of the International Drinking Water Supply and Sanitation Decade

This chapter reviews the donor system. It describes the development of contemporary foreign aid philosophy or the environment of the system and ~~and~~ its effect on project design. The origins of the IDWSSD are identified and discussed. The chapter continues to review present aid trends and issues particularly the role of technical assistance and non government organizations which are two of the main actors in the donor system and the rural water and sanitation sector.

not mentioned in the book

2.1 Foreign Aid - Trends and Issues

One of the dominant institutions or systems in the model outlined in chapter 1 are the donors who form the conduit for overseas aid. The origins of overseas aid can be traced to "infant colony subsidies" provided by the Governments of Britain, France and Germany even before the First World War. These grants in aid were not based in moral obligation, but intended to prop up the bottom end of the international capital markets, as the sources of private capital were not interested in investing in the poorer developing countries. 1914 is seen as the climax of the golden age when 75% of all overseas assets were held in the Americas and Europe (Mosely, 1987).

Between the World Wars, the USA overtook Britain as the main source of overseas investment capital, but the period experienced a sharp decline in overseas investment caused by the wide spread economic depression at that time. This resulted in European Countries and the USA adopting protectionist policies that contributed to the default on

loans by many Latin American countries, and which further undermined confidence in overseas investments. Strangely, it was during this period that the idea of aid for development was first discussed, albeit as a means to relieving unemployment in the donor countries (Mosley, 1987). During the Second World War sources of raw materials became important to the European nations, and projects to enlarge and protect the "human capital stock" were launched. These programmes which included health, education and food sufficiency lasted until the early 1950's.

1947 saw the foundation of the International Bank for Reconstruction and Development (World Bank) whose purpose was to support the reconstruction of Europe after the Second World War. The early 1950's saw the beginnings of contemporary aid with the United States development programmes in South Asia which followed the Korean War. The US development programme was aimed at containing the spread of communism through a demonstration of the efficiency of capital economies over centrally planned economies. Concession capital was provided to poor countries on the communist periphery (South Korea and South Vietnam) in order to revitalize their economies using the Marshall Plan model developed in the reconstruction of Europe after the Second World War. At this time the World Bank switched its focus from the reconstruction of Europe to overseas development.

After the non aligned countries conference in Bandung in 1955, the Soviet Union entered the scene as a major donor of foreign aid (Walters, 1970). The Third World was effectively divided into pro communist and anti communist groups with five countries (India, Egypt, Iran, Afghanistan, and Indonesia), sitting neutrally in the middle and thus becoming the object of "superpowers" attention. Foreign aid was used as the instrument of persuasion. During the late 1950's and early 1960's, the British and French aid programmes rapidly expanded as many of their African colonies were granted independence. Some of these newly independent colonies became the focus of

attention for further competitive aid from the superpowers, particularly Ghana, Nigeria, Kenya and Zambia.

The early 1960's saw Japan, West Germany, Holland and the Nordic Countries also becoming substantial foreign aid donors. This broke the monopolies of the superpowers and reduced the potential for political leverage. Which led to a major shift in aid philosophy and a refocussing on the developmental impact of aid. The 1960's became the first UN Development Decade and targets of 5% GNP growth were set for the Third World, together with targets of 0.7% GNP contributions from donors. Most donor countries established their own aid policies and strategies. This marked the emergence of competition between donors regarding the quality of their programmes, and the domestic political pressures to disburse the aid budgets. The Development Assistance Committee of OECD was established to coordinate and support the aid effort of the western donors and multilateral aid programmes through the UN system, and the Regional Development Banks rapidly expanded (White, 1974).

It was not until the end of the 1960's that the results of the the first development decade were seen. It became apparent that recipient countries were not absorbing the volume of aid that was being provided, and the aid was not benefiting those who were in greatest need - the poor. During the early 1970's, in response to widespread famine in Africa, the World Bank announced that it would substantially increase its concentration on improving the welfare of the poor (World Bank, 1980). This policy was rapidly adopted by most of the European donors and led to a "basic needs" approach to development, and a sharp increase in agricultural aid in the second half of the 1970's. The development of the basic needs approach, and the subsequent Primary Health Care philosophy, together with the parallel development of the appropriate technology movement, contributed greatly to the origins of the International Drinking Water Supply and Sanitation Decade of the 1980's. The post World War Two economic and political debate leading to this is discussed below.

2.2 The Dethroning of GNP.

Neo-classical economists strongly influenced by Sir Arthur Lewis (1955), and others, argued that economic growth should be the basis for development policies which in turn would stimulate socio economic change that would trickle down through the fabric of society to the lower levels and have a number of spin off effects including the alleviation of poverty. The primary objective of this policy was to achieve a high level of sustained growth based on increasing output and productivity. A particular emphasis was placed on the need to transform the economic base of developing countries from agriculture to industry. The so called "modernists" model of development was based on the massive industrial expansion of western Europe in the nineteenth and twentieth centuries. Development was seen as a one way process from poverty and ignorance to prosperity and sophistication. This notion implicitly accepts the adoption of western values, life-style and culture. Emphasis was placed on directing investments into large scale agricultural modernization, industrialization and urban growth.

There were three main justifications for the emphasis on growth as the principal performance test. Firstly, it was assumed that through market forces, that is, rising labour demands, higher productivity, higher wages and/or lower prices that economic growth would spread its benefits widely and speedily. Secondly, it was assumed that governments were democratic or at least concerned with the fate of the poor and through actions, such as progressive taxation, and provision of social services, would spread the benefits downwards. The third justification was much more hardheaded and believed that the fate of the poor should not be a concern in the early stages of development. It was thought necessary first to build up the capital and infrastructure of a developing country, together with its productive capacity, in order to improve the lot of the poor at a later stage. None of these

assumptions and justifications turned out to be universally true.

Except for a few countries, there was no tendency for income to be widely spread, nor did governments take corrective action to reduce poverty, and it was certainly not the case that a period of enduring mass poverty was needed in order to amass capital.

It became evident that the Lewis model which strongly dominated academic thought and political action did not work for four main reasons:-

- i) Rural-urban income distribution differentials were much higher than assumed because of minimum wage legislation and other factors, many of which were inherent from colonial days. This caused massive migration to urban areas and impeded the absorption of the rural work force.
- ii) The rate of growth of the population and hence the work force was much higher than anticipated.
- iii) The technologies transferred from the western world to the developing urban sector were often labour saving and although productivity increased, additional jobs were not created.
- iv) In many countries a revolutionary raising of agricultural productivity was a precondition for widespread progress in industry - this did not occur.

It is not surprising then that attention turned away from Growth and GNP tables, some even called this the "dethroning of GNP" (Mosely, 1987). During the late 1960's and early 1970's criticism was levelled at both the philosophical and operational or practical aspects of the modernist model. It was felt that development was unbalanced and aimed at the urban and industrial sector at the expense of the rural areas, and that the policy was based on the false assumption that development could be measured in economic terms without giving due consideration to social, political and environmental issues.

These criticisms were drawn from two perspectives, the Marxist political economy school of thought, and the liberal "basic needs" school. The Marxist focussed on the

structural constraints to development and argued that development in the third world was mainly constrained by the economic forces exerted by the capitalist developed countries of the west. The major contribution of this approach to the evolution of development theory was that it inspired other challenges to the modernists particularly from the basic needs school; it also brought to light questions regarding equity, distribution and justice (Streeten et al., 1981).

Basic needs proponents argued that development was a complex and subjective process that rejected growth as the catalyst. They went on to provide pragmatic guidelines for development rather than abstract theory. This new consciousness in development thinking was benchmarked by a number of events in the 1970's including; the joint publication of the book "Redistribution with Growth" (Chenery et al., 1974) by the Institute of Development Studies, University of Sussex and the World Bank; the Cocoyoc declaration of the UN in 1974 which confirmed its commitment to appropriate technology, basic needs and self reliance; the ILO Conference in 1976 in Geneva on Employment Growth and Basis Needs (ILO had pursued since 1969 a policy of job creation in rural areas); the designation of the 1980's as the IDWSSD by the donor community in 1977; the setting of the goal of "health for all by the Year 2000" by WHO in 1978.

2.3 A Basic Needs Approach

At this point we should examine the basic needs approach particularly its implications for intersectoral coordination. Streeten (1981) and other proponents of the basic needs approach argue the following; in formulating policies aimed at alleviating poverty a good deal of attention has been paid in the economic literature to restructuring patterns of production and income so that they benefit the poor, but similar attention has not been given to the consumption side. This balance should be

established and the basic needs objective placed at the centre of the development dialogue. Furthermore, direct methods to increase the productivity of the poor should be supplemented with efforts to meet their basic needs for the following reasons:-

- i) Education and health are required in addition to machines, land and credit to increase productivity.
- ii) Few poor people have physical assets. The only assets they possess are hands and a willingness to work. In this situation there is a compelling argument for investment in human resource development.
- iii) It is not enough to enable the poor to earn a reasonable income, they also need services and goods on which to spend their income. Markets do not always supply public services and wage goods, and the expansion and redistribution of public services and production of wage goods becomes essential if the basic needs of the majority are ever to be met.
- iv) It may take a long time to increase the productivity of the absolute poor to a level at which they can afford basic services and needs for a productive life. In the interim there may be a need to provide some short term subsidy to perhaps the bottom 10 to 20 percent of the low income group.

Streeten stresses that "basic needs" is not a welfare concept, but that improved education and health make a major contribution to increased productivity. A basic needs approach tries to ensure that all human beings have the opportunity to live full lives. The approach has three objectives. Firstly, that the poor have real incomes that are adequate to buy necessities such as food, clothing, household goods, transport, fuel and shelter. This in turn implies productive and wage earning livelihoods that give people a claim on what they produce and recognition of their contributions. Secondly, that the poor have access to public services such as education, health care, water and sanitation. This implies a physical

and social infrastructure adequate to provide basic goods and services on a sustained basis and to allow for the growth of improved basic needs provision. Thirdly, to allow participation in the formulation of projects, programmes and policies by the people affected by them, and mobilization of local under-utilized resources.

Although Streeten concedes that the definition of basic need sectors is somewhat arbitrary, he states (1981, p128) that:-

"The main elements of a "cross sectoral" approach are unquestionably; nutrition; health; education; water and sanitation; and shelter."

This classification of basic needs is compatible with the structure and organization of many government ministries and with the sector lending and aid programmes of development agencies and donors. However, it is ironic that few of these programmes are linked. The rationale for these basic needs categories is summarized below.

The need for food or nutrition, is perhaps the most basic of all needs. The poor must eat, even if they drink unsafe water, are illiterate, and are not inoculated. The poor in the developing countries spend about 70% of their total income on food and more than 50% of additional income. Lack of adequate food not only makes people hungry and less able to enjoy life, it also reduces their ability and by causing apathy, their willingness to work. It also makes them more susceptible to disease by reducing their immunity to infection and other environmental stresses. Prolonged malnutrition among babies and children leads to reduced adult stature; severe malnutrition is associated with decreased brain size and cell number (Streeten et al., 1981).

It has been said that better health and longer lives accelerate population growth and imply a return to the Malthusian trap. It is, of course, true that the drop in mortality rates which lengthened life expectancy, has been a major cause of population growth, since fertility did not fall in step. Recent evidence, however, suggests that

high rates of infant mortality are a main reason parents want larger families and that they may over-insure against the risk of their children's death. Anything that reduces infant mortality removes this motive, tends to reduce fertility, and, after a time lag, may lower the rate of population growth.

Education plays many roles in the development process. It is itself a basic need because it enhances the people's understanding of themselves, their society, and their natural environment and gives them access to their cultural heritage. It improves living skills, increases productivity by improving work skills, and lowers reproductivity by raising women's status. Perhaps the greatest value of education at low levels of living lies in its contribution to meeting other basic needs. Education can greatly reduce the cost of nutrition, health and water and sanitation programmes.

Adequate supplies of safe water and a sanitary system of waste disposal are important elements in human health. According to the World Health Organization, diseases related to unsafe water supply and poor sanitation rank among the top three causes of morbidity and mortality in most developing countries. It is estimated that as much as 70% of all nonfatal diseases in developing countries can be attributed to poor water supplies, lack of sanitation and poor hygienic practices, and water is clearly an important element in any rural development programme (WHO, 1981). One to two litres of water daily is a physiological necessity; without it, people cannot survive. For a reasonable minimum standard of living, people need twenty five to forty litres daily of convenient and safe water for drinking, food preparation, and personal hygiene. The close proximity of water spares women the time-consuming task of fetching it and frees them for more productive work and for more attention to other basic needs. The disposal of human waste in such a way as to remove it from human contact is also important for health. In many rural areas this can be accomplished without much investment.

In both urban and rural areas there is a need for shelter of a reasonable standard to protect health and provide a tolerable environment in which people can live. However, the basic need for urban shelter is more acute, although the basic needs for upgrading living accommodation in rural areas should not be neglected.

In summary basic needs can be considered as a liberal response to the inadequacies of the modernistic approach that argues for reducing the levels of poverty by reaching the poor first whilst contributing to overall growth and development. Basic needs deemphasizes the top down donor system approach and perceives the need to strengthen the government and community systems. However, in practice, the major draw back of the basic needs approach is its demand for successful coordination of multiple sectors, systems and actors.

2.4 Primary Health Care and Rural Water Supply and Sanitation as a Basic Needs

The Primary Health Care (PHC) philosophy draws heavily on the concept of basic needs, and has formed an effective link between the health, and water and sanitation components of the basic needs approach. This link should be examined in more depth. The World Health Organization (1978, p2), has defined health as:-

"A state of complete physical, mental and social well-being and not merely the absence of disease or infirmity".

On this broad definition, health can be identified as the primary basic need, all the other basic needs components being "inputs" into the process that produces good health.

Primary Health Care is based upon a move away from centralized curative forms of treatment to decentralized preventative forms of medicine; it provides for community level health care facilities and extension services. PHC may include investments in water supply and sanitation

improvements, together with immunization, maternal and child health (MCH), family planning and nutrition programmes (UNICEF, 1985). The major objective of this approach is to provide access to basic preventative health care to as wide a population as possible within limited economic resources (WHO, 1978). The approach recognizes that western forms of health care are inappropriate for developing countries where the majority of the population are poor and live in scattered rural settlements or overcrowded urban slums and squatter areas, where they are often exposed to the vectors of water and excreta-related disease. There are substantial differences in health between urban and rural areas within developing countries. The crude death rate for 1960 in the rural areas of the developing countries was estimated by the United Nations at 21.7 per thousand, compared with 15.4 for urban areas. The situation is the opposite of that in nineteenth century England, when death rates in cities were higher than in the country. Town people today enjoy comparatively better health because of higher incomes, better sanitation and water supply, greater literacy, and better personal health services. These conditions do not exist the rural areas of most developing countries.

In developing countries as a group, life expectancy is about 53 years, but there are large regional differences. In Africa it is about 47 years, in South Asia 49 years, and in Latin America about 61 years. By contrast, in Western Europe and North America it is about 72 years. This gap is largely due to very high death rates among children. In the poorest regions of the poorest countries half of all children die before the age of five. In Africa the infant mortality rate is over 100 deaths per thousand births compared with 15 per thousand in developed countries (World Bank, 1987). However, life expectancy and infant mortality are very imperfect indicators of the state of full health defined above.

The major killers of small children are gastro intestinal and respiratory infections, measles, and

malnutrition - conditions for which inexpensive prevention or treatment is technically possible. The principal nonfatal diseases in developing countries are gastro intestinal and respiratory infections, skin diseases, and the main tropical diseases such as malaria and parasite infestation. Contemporary medical research in developing countries has determined that as much as seventy percent of these diseases are related to poor water supplies, lack of sanitation and poor hygienic practice (Bradley, 1978). This has led to the provision of improved water supplies and sanitation facilities being seen as a main component of a health strategy which seeks to prevent rather than just cure disease. The changing approach to rural water and sanitation project design and implementation practice during the 1970's, was strongly influenced by the move towards a Primary Health Care philosophy (Bradley, 1978).

The supply of water and sewerage or sanitation services has expanded in only the developed and middle income countries during the past twenty-five years. Whereas, the quality of service in low income countries has declined drastically. World Bank estimates (1988) suggest that fewer than 500 million of the 2,500 million people in the developing countries have access to adequate supplies of safe water; the number without access is growing by 70 million every year. The percentage (25 to 27 percent) of people served with waste disposal facilities has not increased substantially. Recent estimates put the capital cost of achieving universal access to adequate water supplies and sanitation facilities between US\$200 billion and US\$600 billion (WHO, 1988). To meet the basic needs in water and sanitation facilities, many issues must be resolved. These may be roughly divided into the "hardware" questions of appropriate water delivery and waste disposal systems and standards of water quality, and the "software" questions of institution building, training and health education, and financing (Streeten et al., 1981).

The links between health and water have been further highlighted internationally, by WHO, which has promoted a

twenty year concentrated effort into improving health in the Third World. In parallel with the IDWSSD, the 1980's and 1990's are designated as the Health Decades, the major theme of which is "health for all by the year 2000". Primary health care like basic needs represents a change in aid philosophy that provides a new balance between the systems involved by deemphasizing the centralized donor - western approach and recognizing the needs to reorient the government system and involve the community.

2.5 The Appropriate Technology Movement

In parallel with the development of the basic needs approach and the Primary Health Care Philosophy, the use of appropriate technology was gaining increased recognition. The advocates of "appropriate technology", believe that technology choice is a strategic decision in all development projects. It is believed that alternative technology options are available for achieving particular policy objectives and that choice of technology is determined by the developmental goals that are being sought (Stewart, 1977). For example, the choice between opting for a capital-intensive or labour-intensive technology depends on the objectives of the policy to which it is being applied - whether the goal is to maximize economic growth, or to maximize employment creation. In this respect, the appropriate technology philosophy can be seen to complement the arguments put forward by the Basic Needs school in their challenge to the western model of development and its obsession with growth.

The appropriate technology philosophy developed in the 1960's and 1970's, argued that fundamental changes in the way that development was understood by both the developed and third world were necessary in order to avert social and ecological disequilibrium. This argument was shared by other academics and politicians who believed that present levels of growth and resource depletion were unsustainable in the developed world, let alone in the

developing world. It was proposed that alternative or intermediate technology options, reflecting non-growth orientated development models should be encouraged (Dunn, 1978). This alternative perception was defined by Schumacher (1973). He argued that not only was the western model inappropriate for the developing world, but that the obsession with growth and materialism would bring about the demise of western civilization too.

In the water and sanitation sector appropriate technology has assumed a special significance. In water supply it has come to mean, a move away from sophisticated western style water treatment plants and piped distribution schemes to the use of public standposts or wells and handpumps. Whereas, in sanitation it has come to mean the use of latrines as opposed to western style flush toilets, sewers and sewerage treatment plants.

Public standposts are an appropriate technology in areas where water has to be distributed to a large number of people in densely populated areas at minimum cost. For rural communities the main alternatives are communal systems with standposts or, properly located and constructed, village wells and springs. Simple standposts or wells cost about US\$10 per person in rural areas; whereas the costs for private house connections may rise to US\$75 in rural areas and twice that in urban areas.

A properly located, constructed, and maintained latrine will generally meet all public health requirements for the sanitary disposal of human waste, whatever the design, be it simple vault or pit, one with a complex water seal or a conventional water flush system. Costs vary between about US\$5 per person in rural areas and US\$15 to US\$100 in towns, whereas piped sewerage may cost ten times more. No one latrine design is better for health than another; the preference depends on a composite of cultural, aesthetic, social, technical, and cost factors (Becher, 1980). The move towards appropriate technology also represents a move toward strengthening the government and community systems by providing tools for their development

and indicates a move away from top down donor system control.

2.6 The Origins of the International Drinking Water Supply and Sanitation Decade

The idea of designating the 1980's as the Decade during which the United Nations system would try to focus global resources into the improvement of water and sanitation service levels in the Third World was first voiced at the World Water Conference in Mar del Plata, sponsored by the UN in 1977. This conference was inspired by an earlier UN meeting, held in Canada in 1976, on Human Settlement, which was sponsored by HABITAT. The 1976 conference drew specific attention to the interrelationship between health, wealth and welfare (Bourne, 1984).

At the World Water Conference, an agreement was reached between donors to work towards a concerted global effort to manage water resources, and as a priority for action, to accelerate the provision of water for domestic consumption together with sanitation and education. The outcome of the conference, was the decision to establish the United Nations International Drinking Water Supply and Sanitation Decade (IDWSSD) for the period 1981 to 1990, the goal being "water for all by the year 1990".

The major objective of the Decade was defined as being to mobilize awareness of the importance of water and sanitation provision in contributing to the improvement of both health and economic productivity, and to dispel the idea that provision of these services should be viewed as an engineering or technical challenge.

The major topics of discussion at the conference were; the need for appropriate technology; possible ways of reducing the level of infant mortality; the risk of disease from epidemics; and the social drudgery associated with the use of polluted and inconvenient sources of water, and the indiscriminate disposal of human wastes.

The origins of the IDWSSD can clearly be traced to

the three roots described earlier, that is, the basic needs and primary health care philosophies, and the appropriate technology movement, each of which deemphasize centralised donor control. However, it can be argued that the IDWSSD was a move by the donor system to bring the subject back into its sphere of influence.

Note - top camp of dev countries rejected IDWSSD

2.7 Present Views on Aid Policy:

with the above, and some of the...

Donor philosophies such as "basic needs" impinge on their perception of the common task environment of development and the process of transforming resources to projects, as illustrated in figure 4. In the early 1980's a number of donors became increasingly concerned that the current focus on poverty and equity was not sufficient to stimulate the developmental process. This has led to a differentiation in the aid strategy and policy adopted by the western donors during the past decade. The World Bank has led a movement of "economic liberalization", by trying to improve the efficiency of the economies of developing countries through pricing policies and other interventions, particularly reorganization and reorientation, policy reform and administrative capacity building. Britain and the USA are amongst the followers of the World Bank's lead, and are thus not major supporters of the IDWSSD. Whereas, donors such as the Nordic Countries, West Germany and Holland continue with aid programmes aimed at poverty relief, and are thus major supporters of the Water Decade (Mosley, 1987).

The 1980's also saw the aid debate in the political arenas of the west turn away from increasing aid flows. The conservatives continue to argue that aid reduces the amount of efforts a recipient country is likely to make for itself, and that aid impedes an international division of labour and encourages inward looking economic and self-sufficiency policies. The socialists argue that by redistributing money to countries now, it becomes more difficult for the poor to assume "power" later as they

become entrenched in power regimes that are intent in continuing to exploit them (Bauer, 1981). However, despite the macro economic and political arguments, aid programmes do continue and the issues presently being debated by the designers of these programmes are centred on what should be the role of the various systems in the development process, that is, governments, donors, and people themselves? These questions stem from a growing consensus of opinion that developing country governments, because of their limited capacity to implement projects, should divorce themselves from direct involvement in the provision of social services, as by assuming this role they become the constraint to improvement rather than a vehicle for development (Roth, 1987). Furthermore, that projects in which communities are fundamentally involved have a much greater chance of success (Bamberger, 1988).

It is also becoming apparent that donor pressure and precedent for major economic and institutional reforms in the drive for economic liberalization and administrative capacity building, has had limited success because these recommendations pay little regard to the political and bureaucratic realities of the countries in which they are to be adopted, and of the government officers who have to implement them (Cohen et al., 1985. Heaver, 1982). This has been particularly apparent in the development of sectors such as water, where in the past, some donors from their powerful central position have recommended major institutional reforms and structural change; these recommendations were rarely adopted, or if adopted rarely implemented.

Chambers (1983) in his treatise on the misperceptions of outsiders on rural poverty in developing countries assumes the perspective of the beneficiaries, that is, communities, and addresses two interlinked issues that are pertinent to this thesis, professionalism and the resultant misguided approach to project design. He recognizes two cultures of rural outsiders (both nationals and expatriates), these are. First, positive practitioners

often professionals from central government or donors who are responsible for identifying problems, taking action, and allocating resources. He typifies them as often being narrow in their objectives, over optimistic and unable to accept discordant information. Second, negative academics who are trained to, and build stock by criticism and fault finding. Although these critical attitudes have made great contributions to the understanding of rural development, negative interpretations can be misleading as they may be the result of selective perception and choice of research topic. When discussing critical analysis, Chambers states (p33) that:

"The danger is that it becomes inbred, loses touch with reality and practice, and then degenerates into sectarian narcissism and scholastic squabble as social scientists speak less and less to anyone but themselves."

Chambers also expands the concept of top down vertically planned projects by adding the dimension of centre-outwards or the core-periphery approach to the planning of projects which fails to understand or even see the reality of the rural situation because of the urban/centre bias of the rural development practitioners responsible for designing projects. Chambers concludes his treatise by calling for a "new professionalism" in which commonly accepted practice of professional training and project design and management is reversed, emphasis being placed on learning from and empowering the beneficiaries.

In contrast Wood (1985) in his treatise on the politics of development attributes the phenomenon of "labelling" to certain kinds of management of public resources, namely, bureaucratic and professional. Labelling is defined as universalization of specific choices and ideas in order to compartmentalize the management of services. Labels also serve to designate power and to imply the relationships of power and subservience. The political debate in development policy is replete with examples of these labels and abstractions; donors, recipients, experts,

masterplans, minimum needs et cetera, even the word "development" itself is a metaphor. Woods argues that there are two levels of power relationship in development; donors to recipient governments and governments to people, and that the process of labelling undertaken by the professionals and bureaucrats at both these levels have constrained and inhibited lateral thinking - the ability to see new possibilities, different from those of the existing order.

Within the context of the water sector supra systems model, the traditional forms of donor "technical assistance" and its related professionalism, and the emerging role of "non government organizations" as an alternative aid mechanism are worthy of closer examination as these are two of the main actors in the donor system which are of particular interest.

2.8 Technical Assistance and Professional Bias

One of the major features of many multilateral and bilateral aid programmes has been the provision of experts or professionals on a short term basis (typically two years), to assist developing countries. These experts who have been the main actors in the donor system for some time are most often in the form of consultants who provide a specific service for a government body, such as the design of a road or bridge, or in the form of individuals who are placed as advisers, or line managers within the government body. The general concerns that have been raised concerning technical assistance include (Forss, 1988):-

i) that the personnel often see their first loyalty as being to the parent donor, and they are used by the donor to ensure timely and proper disbursement of aid funds rather than to build capacity within the government to undertake the function assumed by the expatriate. This is exacerbated by the evaluation of the advisers being output oriented.

ii) that the personnel often lack the relevant knowledge,

unassisted
for info

low funds

skills or appreciation of the local environment to allow them to design and implement development programmes; this is exacerbated by short project cycles and discontinuity of staff.

iii) that the personnel and other policies of the donor determine if technical assistance should be provided, not the needs of the specific developmental activity. This leads to poor project performance.

iv) that the use of expatriate consultants is an effective mechanism for recycling aid funds back into the donors own economy.

v) that the use of expatriate personnel inhibits the development of local managerial skills and self reliance.

A growing consensus of opinion believes that technical assistance should be removed from the managerial and decision making structure of government and the role should clearly be focussed on training and institution building (Lethem & Cooper, 1983. Cochrane, 1984). McNeil (1981), views technical assistance personnel as the intermediaries between donors and recipient governments, and he draws an important distinction between "advisers and consultants" in terms of their self interest. A consulting company is often hired to undertake feasibility studies for aid projects, or provide technical advice to a government on a specific issue, often in the form of a technical report. Although consultants are supposedly the servant of both the donor and the government, their dominant interest is to satisfy the financing agency which is almost invariably the donor. Their secondary interest is to maintain their own involvement and profitability. Consultant often play a major role in the aid process. However, they tend to reinforce the interests of the donor rather than the recipient government. By contrast, advisers have a much broader role and often work closely with a government for a longer period with open ended responsibilities. However, like the consultants they are often recruited and paid by the aid agency and their dominant interests are to continue being employed and to

to
200
7
problem

improve career prospects. Advisers have a strong incentive to maintain good relations with both camps which often means keeping a low profile and therefore having less impact on the development process.

Within the water sector a major concern is the domination of the engineering disciplines in technical assistance programmes. The engineering experts, or professionals employed by the donor or as consultants and advisers, often bring with them a technocratic approach and a reluctance to interact with other disciplines which tends to reinforce sectoralism, reduces effective coordination, and almost invariably leads to the design of vertical projects with poor social components. This is a good example of the groups and boundaries established by professionals in order to maintain their own perceived interests, often referred to in organizational theory (Salaman, 1986).

2.9 Non Government Organizations - The Voice of the People

A second important debate that is presently taking place in aid circles concerns the role of private voluntary organizations or non government organizations (NGOs), as they are commonly termed, in the development process. NGOs who are relatively new actors in the donor system, were initially known for their relief activities, but are now becoming much more involved in socio economic development particularly at village level, and are influencing the aid policy and practices in both developed and developing countries.

Although the scale and structure of NGOs is diverse, two themes are common in their approach; self reliance and people's participation. As a product of this approach NGOs have served as a "voice of the people", which has sensitized developing country governments and aid agencies to the needs of the poor. They have also taken a lead in demonstrating that rural development projects in which communities are fundamentally involved are more likely to

achieve greater success than those projects which do not.

Recently, aid agencies and developing country governments have begun seeking ways to optimize scarce resources and to improve the performance of their aid initiatives. This has signaled a move toward using NGOs as a conduit for aid flows, and as a means of providing the social dimension in projects. There are, however, problems with the involvement of NGOs in the activities of major donors. Most NGOs strive to work independently of government agencies. They often argue for greater political power for the poor as counterweights to the disparities common in many developing countries. Equally, many government officials express reservations about NGOs, claiming that they are politically hostile and disrupt overall development. In parallel with this, some observers from development agencies criticize individual NGO projects as being confrontational, erratic or poorly designed and being "welfare" oriented, which disrupts the development of self reliance, and strong national institutions. In contrast, other donors promote a policy of using NGOs whenever possible as an extension of their "basic needs" approach (Mansoni, 1985).

It is apparent that NGOs have gone well beyond short term relief operations, and have demonstrated an ability to work effectively at "grass roots" level in the provision of basic needs. A growing number of developing country governments value the contributions of NGOs to their development programmes, as demonstrated by the establishment of special offices to foster and coordinate activities (Gorman, 1984).

In the water sector, as project design trends move towards community involvement, and away from master plans and vertical projects, the role of NGOs in project implementation is becoming an important factor in project success, and may provide a valuable counterweight to the more conventional technical assistance approach (Warner, et al. 1986). NGOs who are becoming an important actor in the donor system as they can form an efficient boundary *

Them
De
...

spanning device between the government and community systems.

2.10 Summary

As shown in figure 4, the donor, government and community subsystems are independent. This chapter has outlined various ways of conceptualising the donor system. Each approach has different implications for the relationship between the subsystems and the variables which are assumed to characterise sector development and its common task environment. In the following chapters we look more closely at the influences of foreign aid in rural development and the water and sanitation sectors.

It has also been demonstrated that the International Drinking Water Supply and Sanitation Decade of the 1980's is a product of the trends in aid philosophy which have moved from the post World War II focus on improving Third World GNP by industrial expansion, which ended with the growing awareness that the "trickle down effect" was not taking place. Through the first UN Development Decade of the 1960's, during which it was found that aid was not reaching those most in need - the poor. To the evolution of the basic needs and primary health care approaches of the 1970's, both of which were perceived to have essential water and sanitation components. The launch of the IDWSSD was reinforced by the 1970's appropriate technology movement that had a special significance for the water sector. That is, the move away from western hi-tech water and sewerage treatment plants to the development of appropriate technology such as robust handpumps and hygienic on-site latrines.

However, as aid trends continued to evolve through the 1980's, the donor projects and programmes launched in the earlier part of the decade, including those falling under the IDWSSD umbrella, are now becoming the subject of close scrutiny and international debate. Recently at a political level the aid debate in the west has centered around

whether or not to increase aid flows. The conservatives argue that to increase flows reduces a developing country's own efforts and self reliance. Whereas, the more liberal argue that it is better to redistribute wealth now, as to do so later may be too late for the poor who will be entrapped in power regimes over which they have no control. At the aid practitioners level, given the above conflict, the aid debate is centered around the issues of - what then should be the relative roles of the three principal interest groups or systems; donors, developing country governments and people themselves in the development process? Two specific issues arise from the above debate are pertinent to the examination of the donor system.

First, the use of advisers or consultants in aid projects. Technical assistance to developing countries has been for some time a major component of most aid programmes (or actors in the donor system). However, the questions presently being posed are. What is its real purpose and value - do the advisers serve the donor or the country? How best can it be structured - should the advisers be line managers or facilitators? Who are the most appropriate people to offer advice - is the typical adviser able to address the real problems and issues given his professional training and biases?

Second, the potential role of non government organizations who are relatively new actors in the donor system. There is a growing consensus of opinion which believes that because of their unique character NGOs are able to act as intermediaries in the aid process by filling a perceived void between donors, developing country governments and people - the ultimate beneficiaries of aid. Although the scale and structure of NGOs is diverse, two themes which are common in their approach have led to the successful implementation of a number of projects which have directly benefited people at grass roots level. These are, self reliance and peoples participation. This approach now serves as model for many project designers.

- o 0 o -

Chapter 3

The Evolution of Rural Development and
Water Supply Projects.
and a
Model for Rural Water Supply and Sanitation
Project Design and Sector Development.

- o 0 o -



Chapter 3

The Evolution of Rural Development and Water Supply Projects.

and a Model for Rural Water Supply and Sanitation Project Design and Sector Development.

This chapter reviews the evolution of rural development project design in the Third World since the early 1950's. It contrasts this with the parallel evolution in the approach towards the design of rural water supply and sanitation projects, which culminated in the launch of the International Drinking Water Supply and Sanitation Decade. The chapter goes on to review present development research trends in the water and sanitation sector. Finally, a conceptual systems model for the development of rural water supply and sanitation within a broad rural development context is proposed.

3.1 The Evolution of Rural Development Project Design

Approximately 85% of the 750 million poor in the developing world are considered to be in a state of absolute poverty; of these 80% live in rural areas. Agriculture is the main occupation of the rural poor, most are small scale farmers, tenants, sharecropper and landless labourers and their families (World Bank, 1980). However, only within the past ten years has the alleviation of this poverty become a major tenet of rural development philosophy.

The design or process of rural development has received increasing interest, particularly since the mid 1960's response to the food shortages in South Asia and other parts of the third world, and a growing recognition that the developmental approaches of the neo-classical economists had failed. The evolution of development

philosophy since the 1950's is reflected in the changing designs of rural development projects which can be classified sequentially as (World Bank, 1988):-

- Commodity Programmes (1950's and 1960's).
- Coordinated National and Regional Programmes (1960's).
- Minimum Package Programmes (1960's).
- Area Development Schemes or Integrated Rural Development Programmes (1970's).
- Functional Projects (1970's).
- Sector and Special Programmes (1970's and 1980's).

a) Commodity Programmes

The first investments in the development of low-income subsistence agriculture, particularly in Africa, were prompted by the simple objectives of increasing export crop production from small-holders. They were financed by European commercial undertakings, development corporations and colonial governments, and proliferated in the 1950's and 1960's. Examples are the Kenya Tea Development Authority, which was established to increase tea production of rural small-holders, the Tanganyika Agricultural Corporation, and the British American Tobacco Company, which promoted tobacco growing in the Urambo and Tumbi regions respectively of Tanzania. The major influences in these programmes were the colonial donor governments and their private sectors.

b) Coordinated National Programmes

These were intended to be directed towards a large spectrum of the rural population based on careful analysis of resources and needs. The objectives of the programme were to provide resources and services in order to increase employment, improve social infrastructure and provide production services. This kind of approach was seen in the programmes of Japan, Korea, Taiwan and Mexico in the early 1960's. The criteria for selecting countries or regions to participate were low employment and income levels, and potential for the expansion of production. These programmes

represent the beginnings of contemporary aid approaches.

c) Minimum Package Programmes

The origins of the minimum package approach were based on experiences with the national and regional programmes which were judged to be too complex, comprehensive and expensive to be replicated, particularly in the poorest of countries such as Ethiopia. However, the national programmes had provided some insights as to essential elements or components of projects which could be singled out as viable minimum packages.

These programmes were intended to stimulate modest improvements in income through increased agricultural outputs, with institutional development being seen as an important element in ensuring mass participation, an earlier label for community participation. Other components of these packages were applied research, extension services, and seed and fertilizer distribution. Models of this approach are considered to be the Minimum Package Project of Ethiopia and the Crop Improvement Programme of South Korea.

d) Area Development Schemes

Area development schemes are similar in some ways to the minimum package schemes described above. However, they were more specifically designed for smaller well-defined target groups and unique physical conditions where a number of inputs were thought to be needed in order to achieve the overall development objective. These inputs included improved seeds, livestock, irrigation, fertilizers, credit and marketing facilities, pricing arrangements together with technical assistance and project management structures. Models of these schemes include the Lilongwe Land Development Programme in Malawi, and the Comilla Project in East Pakistan (now Bangladesh).

The concept of Integrated Rural Development Projects (IRDP) was a development of, and often confused with, the area development approach. It was clearly a product of the

basic needs philosophy. The designers of IRDP projects, who were often agriculturalist or rural planners attempted to provide a balance between productive and other cross sectoral, non-productive social services as project components, for example, the improvement of agricultural production together with health, education, water and sanitation interventions. This often implied integrated management by different sector authorities and was founded on theories of complementarity and synergism that demand parallel improvements. The World Bank claims that in practice this can only be achieved by the discredited "enclave management unit" and that such Utopian schemes have not been successful because of the complexity of their management (World Bank, 1988).

e) Functional Projects

Functional projects were those designed to remove a single constraint that was considered to be particularly critical for getting rural development underway. Investment may be directed only to the development of extension services or to the construction of feeder roads or the provision of agricultural credit et cetera. Functional programmes were attractive having clear objectives, being easier to administer and often more effective in stimulating political commitment and spin-off effects. For example, production for markets may be stimulated by a rural feeder roads programme. The agricultural credit programme administered by Kenya's Agricultural Finance Corporation constitutes such a functional programme. This concept clearly contributes to Lele's model (described later) of providing a few simple interventions to remove critical constraints to start development rolling.

f) Sector and Special Programmes

Sector and special programmes were a category, defined by the World Bank, in which the income of farmers was improved through the provision of a better social and physical infrastructure. This included rural public works,

education and training, and other programmes such as feeder roads, village electrification, water supplies, health facilities and small industries. These programmes were aimed at providing some of the conditions that were thought to be needed for self sustaining increases in productivity. It was felt that a sector approach is complementary to, or a component of programmes with broader objectives. Clearly this approach also drew from the basic needs philosophy but was tempered with a pragmatic view that maintained productivity as the central goal.

The shifts in geo political interests and evolution in the thinking about the fundamental issues underlying the process of rural development has generated a distinct philosophy that is the basis for present day practice adopted by a number of donors in the design of rural development projects. This practice envisages particular roles for the three interest groups or systems involved with much greater emphasis being placed on the role of developing country governments and communities.

3.2 Present Practice in The Design of Rural Development

Present practice can be described as a time phased approach which removes critical constraints through a few simple interventions. This model or approach is discussed in great detail by Uma Lele (1975) based on the findings of the African Rural Development Study (ARDS) carried out in 1972 and 1973 which evaluated some seventeen rural development programmes in Africa dating back to the early 1950's. These schemes were selected from over sixty candidates as being representative of diverse projects involving multilateral and bilateral donors government agencies, and communities. Whilst no limited survey can claim to be exhaustive the ARDS study probably represents one of the largest studies of its kind. The study also draws upon an earlier study commissioned by the World Bank and published in 1967 - "Experience with Agricultural Development in Tropical Africa" and rural sector surveys

carried out by the World Bank in Kenya and Tanzania in 1972 and 1973 (de Wilde, 1967). The study confirmed the World Bank's concern over its rural development policies and unlike the 1967 study was concentrated in three main areas. First, the trend of promoting the participation of low income groups through rural development programmes. Second, the broadening view of development from the perspective of improved welfare as well as increased productivity, and consequently, the need to define priorities and time phasing of productive and welfare components. Third, the recognition of financial, manpower and institutional constraints encountered in recent programmes and the need to find ways of making best use of scarce local resources and augmenting existing rural potential over time. Lele (p26) defines rural development simply as;

"improving the living standards of the mass of the low income population residing in the rural areas and making the process of their development self sustaining".

This definition has three important features with substantial implications for how development projects should be designed and implemented:

- i) Improving the living standards of a subsistence level population involves mobilization and allocation of resources to reach a desirable balance over time between welfare and productive services available to rural poor.
- ii) Mass participation requires that resources be allocated to low income groups and that the productive and social services actually reach them.
- iii) Making the process self-sustaining requires the development of appropriate skills and implementation capacity and the presence of institutions at local, regional and national levels to ensure the effective use of existing resources and to foster the mobilization of additional finance and human resources for continued and sustained development. Self-sustaining thus means involving, as distinct from simply reaching, rural populations in programmes.

Lele also points out that the achievement of developmental goals requires consideration of the interaction of a variety of specific issues which have profound impact on the design and performance of individual projects. These issues may be classified in three general categories as;

i) national policies; for example, land tenure systems, commodity pricing and marketing systems, wage and interest rate structures and so forth.

ii) administrative systems; for example, the degree of centralization or decentralization in the governmental structure.

iii) the scope for institutional diversity; for example, the distribution of developmental responsibility among the normal government structures, non government organizations, foreign aid donors, private commercial and traditional institutions and elected bodies - the three institutions discussed in chapter 2.

Lele contends that because the bulk of the rural population in Africa is poor and this poverty is spread over the entire rural sector, and also as the target group in Africa is large relative to the financial resources, in particular to the trained manpower and institutional capacity available for development, it is essential that the resources of the masses are mobilized. Therefore, if the emphasis in rural development is to be on mass participation and on the viability of the process of rural development, it would seem necessary that rural development be viewed as part of a dynamic process rather than as a series of isolated interventions. The emphasis on mass participation also means that a sequential approach may be necessary in planning and implementing a rural development strategy, involving the establishment of clear priorities and a time phasing of activities.

Lele believes that the use of a sequential approach tends to facilitate the incorporation of several desirable features in programmes. First, it helps to focus on the need for broad-based development of the rural sector.

Secondly, it helps to highlight the crucial role of local manpower and institutions, not only in terms of the effectiveness with which interventions are implemented, but also in planning rural development programmes to take account of variability by revealing the need for manpower and institutional development in the early stages of the programme implementation. It also tends to assure the smoother and more effective expansion of the programme over time. It is also assumed that an increase in productivity of the subsistence sector constitutes a first but major step in the improvement of the welfare of subsistence level rural populations.

Furthermore, for a variety of reasons, planning and implementation of services, such as community centres, drinking water supply and health clinics et cetera, require special considerations. It seems necessary to give even greater scope for local participation in the organization and delivery of these services. In many cases such planning will have to wait until a second developmental phase when incomes and effective demands for such services increase, local skills and capacity for planning and coordination such of programmes are developed, and mechanisms for raising fiscal resources are instituted. Local institutional capability to implement programmes is fostered through an explicit emphasis on the necessary pre-planning in the first phase.

Finally, Lele contends that past programmes indicate, if the process of rural development is to be viable, there is a need not only for expanding administrative coverage but also for improving the performance of the local administrative systems. Technical assistance may be needed, not to manage the projects but to assist in developing local, regional, and national capability to plan and implement rural development programmes. This is some what at variance with present aid practice as discussed in chapter 2.

Summary In summary, Lele recommends that programmes should

begin with only the simplest of interventions to remove the most critical constraints and which allow the programme to evolve through a time phasing of activities. Furthermore, that programme evolution ought to be based on the specific knowledge acquired, constraints identified and the human, institutional and financial capacity developed during the earlier stages of programme implementation. Lele underlines the needs for strengthening the government system and involving the community system, albeit without really defining what these systems are.

3.3 The Evolution of Rural Water Supply and Sanitation Project Design.

When reviewing the literature on rural water supply and sanitation development programme and project design, albeit limited, it becomes apparent that the practice of, or approach has evolved in parallel with the evolution of the design of rural development projects, and that donor organizations have taken the initiative in developing guidelines in order to respond to their own changing philosophies. It is also apparent that a divergence took place in the early 1970's in the approach to rural water supply and sanitation project design, with the larger bilateral donors and others pursuing a national programming approach, whereas the NGOs and some smaller donors opted for developing community based approaches. The move towards involving communities was followed by the larger bilaterals much later. This evolution in the design of rural water supply and sanitation projects and programmes which reflect the changing aid philosophy, may be classified sequentially as:-

- Functional and Service Schemes (1950's).
- Rational Schemes (1960's and 1970's).
- National Development Plans (1960's and 1970's).
- Self Help and Popular Participation Schemes (1970's).
- Rational and Sequenced Community Participation Projects (1970's).

- Participatory Frameworks for Project Design and Management (1980's).
- The International Drinking Water Supply and Sanitation Decade Approach (1980's).

a) Functional and Service Schemes

During the 1950's almost all rural water supply schemes in the developing world, particularly Africa, were designed to serve the needs of specific developments, either agricultural or industrial and their associated labour force. A few rural villages may have been fortunate to receive spin off benefits of a nearby irrigation scheme. However, the move to provide better levels of service for the rural population in general, was not to start until the following decade. At best a few wells and boreholes were provided by the native commissioners of the colonial administrations, in times of drought, this was supplemented by the work of missionaries and charity organizations.

The few service schemes that were provided, were often small conventionally designed installations which included mechanical pumps and pipe networks that could be easily maintained by the artisans employed in the agricultural or industrial undertaking at the expenses of the owners. These schemes which were mainly driven by the colonial donors and their private sectors have become part of the "colonial legacy" and most have fallen into disrepair.

b) The Rational Design Approach of the 1960's

During the 1960's an increasing level of interest was shown by donors in rural water supply and a number of publications became available that provided guidelines for the design of projects. The standard work of Saunders and Warford "Village Water Supply - Economics and Policy in the Developing World", although written later in 1974, summarizes the approaches developed and adopted during this period.

On reviewing the publications of that time (see for

example Burton & Lee, 1967. Okun, 1965. & Kally, 1965) it is apparent that project preparation and design practice drew heavily from the experiences of urban and western situations. Great emphasis was placed on the physical and financial aspects of design particularly the detailed and systematic comparison of costs and benefits. Costs were seen as a function of service levels (quality and quantity) and design standards, whereas benefits were seen as a function of improvements in public health, productivity, income distribution, fire protection, and a slowing of the urban migration rate. Less emphasis was placed on involving the recipients, other than in passing on the costs, and in optimizing potential benefits through complimentary sanitation and education interventions.

The parallel recommendations of that time for national agencies to establish lists of priority villages determined by criteria of need, development potential and cost clearly related the rational design approach to the national programme concept discussed below.

c) National Development Plans

National water sector development plans or master plans as they are often named, first became popular with development planners from the donor system during the 1960's for a number of reasons: They provided a blue print for bilateral aid programmes which had substantially increased in size with the prosperity of that time. They were also seen as a realistic response to the apparent vast scale of needs in the sector which it was thought could only be satisfied by the launching of national programmes. The scale of needs was revealed by the first major WHO global survey carried out in 1962 which covered some seventy seven developing countries (World Bank, 1976).

National planning has been defined as a process by which available data needs and resources are appraised, analysed and used in a preparation for change. Plans spell out, on a long term basis, goals and targets with timetables, implementation strategies and estimates of

capital and recurrent costs; they are the outcome of basic political decisions on sector priorities. These plans are carried out through specific investments and supporting programmes constituted by sets of projects and activities as deemed appropriate and practical in a particular country (Vogel, 1983).

A typical national plan consisted of ten to twenty volumes of reports often prepared by external consultants covering a broad range of issues from hydrogeology, demography, institutional responsibility, design and service level standards, maintenance, training, sanitation, et cetera. and setting out an investment plan for the next twenty five years based on extrapolations of economic and population growth and movement. However, few of these plans were adopted and maintained by the governments which they were intended to serve (Therkildsen, 1988). The reasons for this are many and include:-

- i) Recommendations of unrealistic targets with high levels of service and coverage, without adequate consideration of less ambitious options, resulting in proposals far beyond the financial and institutional resources of the country.
- ii) Too much reliance placed on the uncertain investment potential of governments and external resources for the funding of capital costs, and too little attention given to the increasing recurrent cost burden that would have to be borne by the government.
- iii) Too much reliance placed on the capacity of governments to execute and maintain the proposed schemes, and too little attention given to seeking ways of relieving government of the burden through appropriate technology and the involvement of the community and other agencies.
- iv) Insufficient involvement of national staff at all levels including the principal decision makers for overall economic development in the country, and professionals in the ministries and bodies responsible for implementation, and over involvement of short term expatriate staff resulting in governments often being reluctant to adopt the plans as their own.

v) The anomalous preference of governments and aid agencies for the ad hoc support of bankable projects rather than long range plans with phased targets.

vi) The conditions precedent, associated with these schemes, which often demanded radical change, were politically and bureaucratically unacceptable to the government officers who were supposed to implement them (Cohen et al, 1985).

Tanzania is often cited in the discussion of water master plans. During the 1970's and early 1980's some nine separate bilateral donors and twelve external consultants were involved in producing regional water master plans for seventeen of the country's twenty regions. The volume of data became so great that a special coordinating unit had to be established, staffed by even more expatriates. Despite all this investment in planning (between one and two million dollars per region), service levels in Tanzania did not improve significantly (Schonborg, 1983. Therkildsen, 1988). The penchant for national plans and master plans continued through to the 1980's, promoted mainly by the consulting companies for which they provided profitable employment even though the value of master planning had fallen into doubt (Browne, 1987).

However, the IDWSSD prompted a resurgence of the national planning concept, which can be characterized by being donor driven and the lack of government and community involvement. WHO promoted a technique of rapid countrywide sector assessment and published and distributed globally a planning guidelines and manuals, including, "IDWSSD Plans - Eight Questions They Answer" (WHO, 1981). The National Master Plan for Rural Water Supply and Sanitation prepared for Zimbabwe is probably the last of traditional water master plans.

d) Self Help and Popular Participation Schemes

Self help water supply schemes became popular with development agencies during the late 1960's in response to

a growing realization that the "trickle down" concept of development planning was not having a significant impact on the alleviation of poverty, or in improving the delivery of basic needs to low income groups. This is discussed earlier in this chapter. Figure 5 relates self help water supply improvements to potential developmental benefits, and figure 6 depicts the general project related self help hypothesis (Miller, 1980).

Based on a cross sectional process evaluation of self help rural water supply schemes in seven African countries, and the deliberations of two expert committees; the Ad Hoc Working Group on Rural Potable Water Supply and Sanitation, and an International Experts Group; OECD published a comprehensive treatise on the concepts and practical design of self help and popular participation in rural water schemes (Miller, 1979). These expert groups which comprised representatives from WHO, UNDP, IBRD, UNICEF, IDRC, UNEP, and OECD met on a number of occasions in 1975 and 1976.

Miller differentiates between self help and popular participation on the basis of scale and external influences. He conceives of self help as individual or collective voluntary actions on a limited scale with little, if any external influence, whereas, popular participation is seen as mass or public pursuit of some identified goal, entailing some degree of interaction with an external agency or authority. He goes on to identify the three main characteristics of popular participation:-

- i) Participation in decision making in a dynamic process of discussion, dissent and collective consent from the outset of any project.
- ii) Participation in the implementation of actions agreed upon including for example, labour, provision of materials and supervision of construction.
- iii) Participation in the sharing of costs and benefits of the actions.

The paradigm of self help rural water supply projects developed by Miller is presented in figure 7. It

Figure 5.
Improved Water Supply and Self-help Hypothesis (From Miller, 1980).

Primary Benefit Type	Intervening Variable(s)	Secondary Benefit(s)
Public Health -----	Increased access to consumption of water	
	Higher quality of waste	
	Reduced incidence of diarrhoea	Higher productivity
	Increased frequency of bathing	Higher school attendance Better quality housing
Productivity -----	Better health	Acquisition of skills
	Increased agricultural output	Increased village GDP Greater employment opportunities
	Reduced disparities in obtaining water	New commercial activities
Village Development -----	Greater employment opportunities	Less income disparities Less migration
	Greater awareness of benefits of cooperative efforts	Greater involvement in development projects Better local institutions
	Increased use of local resources	Increased village GDP Increased home ownership
Nationalism and Modernization -----	Increased rate of development	
	Greater democratic participation in decision-making	
	Increased population clustering	
	Greater acceptance of new technology	

Figure 6.

Project Related Self-help Hypothesis (From Miller, 1980).

Step Within Project Cycle	Possible Self-Help Intervention(s)	General Statement of Hypothesis
Design Implementation		
- Identification	- Request for project	- Indigenously identified project represents a high commitment and revealed felt need.
- Design Preparation	- Site selection, system configuration, design and capacity determination	- As above plus participation in design could lead to a more technically appropriate system for community.
- Implementation and Construction	- Provision of local materials, capital and labor (supervisory and workers)	- Participation by providing inputs demonstrates commitment, may lead to more appropriate systems and will decrease costs to central government budgets.
Finance		
	- Initial capital contributions	- As above.
	- Determination and collection of water rates	- Local involvement in fee fixing and collection will lead to more efficient and higher rates of payment.
Operations and Maintenance		
	- Water users organization	- User involvement will lead to less frequent breakdown, cheaper maintenance and therefore less costly and more efficient systems in the long run.

Figure 7.

Paradigm of Self-help and Rural Drinking Water Systems (From Miller, 1980).

WATER SYSTEM LIFE CYCLE							Return to 1.
Problem Awareness(1)	Commitment	Set Alternatives	Design	Maintain Interest	Construction	Administration Management	System Alteration
LOCAL SELF-HELP MODULE							
Perception.....	Need.....			Household..	Ceremony...	Meetings	
	Needs-Desires.....			Visits			
Agenda	(Internalize	Information	Land use	Preparation	Labour,	Staff	
	(Organize			for	Materials	system	
	(Insitutiona-	Rules of system.....	Construction	Staff	policing		
	(lize		Funds				
(Leadership							
(Fund Drives/						Evaluation	
OUTSIDE INTERVENTION							
Awareness generation	Organisation	Standardized packages	Modification long-term	Timetable	T A materials	T A	
Service organisation	Encouragement						
Special campaigns	(Acknowledgement	T A	Syst. plan.	Communication	Credits	Organis. & Mgmt. manuals	Evaluation
	(Acceptance		Training plan	Training		Follow-up Schedules	
Information flows						
DURATION							
Year: 1		2			4		8-10

is set out in phases based on the life cycle of a typical water supply scheme and details local and external actions. The model can be aggregated into five stages; project identification and pre-planning, design, implementation, administration and operation, evaluation and modification. Three specific external inputs are identified in the paradigm, the most important is technical assistance, the others being awareness generation and education.

However, Miller contends that, in practice self help is approached in two general ways, as an article of faith, or as a resource input into construction. The first approach often attributed to NGOs or politicians who assume self help is either an intrinsically good thing, or a necessity of political life. Whereas, in the other extreme technicians and planners regard self help as an issue of resource allocation and an opportunity to reduce costs. These approaches often boil down to perfunctory informal contacts with local elites just prior to construction, and the provision of cash and free labour by the community during the construction phase. However, the move towards self help and popular participation marks the beginnings of the realization of a need to strengthen the capacity of the government system and the fundamental involvement of people or communities.

An important contribution Miller has made is to spell out in detail ways in which interventions can be conceptualised and evaluated. An important part of the systems model is to specify how the outputs of a subsystem may be evaluated as well as how they effect other subsystems and the systems environment. Miller's evaluative suggestions have been used in this thesis to provide a starting point for the detailed analysis of the case studies in chapters 8 to 15. As can be seen, his criteria are mainly focussed on the community system and some important modifications have been made. In particular additional criteria have been added that provide a better understanding of the role of the donor and government systems.

e) Rational and Sequenced Community Involvement Projects

During the early 1980's a number of authors and agencies wrote of their experiences during the previous decade in managing rural water supply and sanitation projects in which special efforts were made to involve communities. The most notable amongst these are Glennie (1983) writing about the gravity piped water schemes in Malawi. Strauss (1983) writing of his experiences in Nepal, and Chandler (1985) writing about projects in Asia and the Pacific on behalf of WHO. Pacey (1980) also produced a rural sanitation planning and appraisal guide based the experiences of the British NGO Oxfam in the late 1960's and 1970's.

Glennie's Malawi Model

Based on his experiences of managing the successful Malawi Piped Gravity Feed Rural Water Supply Programme Glennie describes a model for rural water supply projects that has the following specific elements; planning and selection criteria; community participation and involvement; management; appropriate technology; operations and maintenance; and monitoring and evaluation. In this model, the emphasis is placed on field level organization and management, training of field staff and appropriate technology. Glennie also identifies four phases of a programme development (Glennie, 1983):

- i) The pilot phase in which confidence and demand are stimulated and technical aspects tested.
- ii) A consolidation phase in which staff are trained and technical standards and procedures are established.
- iii) An expansion phase in which the programme is developed into a nationwide activity with government policy and help.
- iv) A maintenance phase into which completed projects enter.

Glennie places less emphasis on financial arrangements and cost recovery, institution building, health education, and social feasibility surveys within the project design. He can also be forgiven for his modesty in

not mentioning his own critical leadership role in the programme's success, together with his colleague Lindsey Robertson (Hill & Mtawali, 1989). Glennie also fails to make links between his four phases of programme development and the overall development of the sector or rural areas in the country. Furthermore, he does not address the community's ability and willingness to pay and hence the programmes replicability in the long term.

Pacey's Planning Guide

In contrast Pacey uses case studies of a number of Oxfam projects to develop a brief project planning guide or model which identifies the following necessary and critical components (Pacey, 1980); surveys and feasibility analysis of environmental conditions, health data and social priorities; appropriate technology, appraisal, availability and choice; health education; extension work and technical assistance; financial arrangements; and monitoring and evaluation. Pacey places emphasis on planning from the basis of local conditions and a community's perceived priorities, and education through extension work and technical assistance.

Strauss's Nepalese Model

Strauss (1983) has analysed and recorded the planning and implementation of the successful Nepalese rural water and sanitation programme as the basis of a detailed planning model which is perhaps the most comprehensive of the three.

Strauss has identified four phases in the development of the programme, these are; feasibility studies; institution building; technical assistance; and maintenance. He then divides the programme into a series of components categorized as either hardware or software:-

1) Hardware Components include; new water supply schemes, rehabilitation of existing water supply schemes, latrines for schools and families, and ferro-cement development for storage tanks.

ii) Software Components Include; the training of foremen, builders, and maintenance workers; community health education; sanitation promotion including the design and building of demonstration latrines, and the production of training materials; design and construction standardization; establishing effective maintenance; refining administrative and implementation procedures; and liaison and communication activities. Like the Glennie model, the Strauss model also fails to explore cost recovery and links to the overall sector development process in the country.

Chandler's WHO Model

Chandler, summarizing the findings of a WHO regional workshop on the planning and design of rural water supply and sanitation projects, draws on case studies in nine countries from Asia and the Pacific to produce a practical and rational step by step guide to project design using appropriate technology/software mixes, and community facilitators (Chandler, 1985).

Six steps are identified in the project design procedure, these are. One, select priority communities and recruit facilitators. Two, use community education and participation to find needs. Three, plan to meet needs with proper software/hardware mix. Four, develop community consensus and commitment to ensure project success. Five, implement the hardware/software mix. Six, establish linkages with a program support network to ensure backup assistance when necessary.

Summary

The rational and sequenced community involvement project models are a logical evolution of the self help/popular participation concept of the 1960's that sought to overcome the practical deficiencies of earlier schemes in involving the community system as identified by Miller. The sequenced community involvement models were an improvement on Miller's model, as they were much more

prescriptive of the process by which people and communities become involved in projects. The model also provided much greater emphasis on the integration of sanitation and education with the provision of water than previously. The models also sought to strengthen the government system in order to ensure replicability of projects.

f) A Participatory Framework For Project Design and Management.

The most recent trend in the development of the community participation model is characterized by Donnelly-Roark who claims that for the past 40 years the donors have operated on the premise that the essential and primary locus of action within community based project design has been that of initiation. However, she believes that a rapid paradigm shift is taking place, and the notion of "sustainability" within projects, has refocused the essential and primary locus of project design to one of responsibility (Donnelly-Roark, 1987).

Donnelly-Roark goes on to propose a new analytical framework for project design based on a premise that external initiators are insufficient to define the problems and solutions related to the concept of sustainability within projects. This approach radically and fundamentally changes the role of the donor and the purpose of community participation in projects as defined in the approaches described above. Participation is defined by Donnelly-Roark (1987, p9) as:-

"The learning process by which communities control and deal with technology, change and development". These are considered to be an essential component of every water supply project that has long term sustainability as its objective. The new analytical framework for project design can be summarized in five steps. One, the analysis of the levels of change within a proposed project. Two, the identification of a proposed management systems. Three, the establishment of a two way information system between the community and the project. Four, negotiation of local

control and responsibility. Five, learning, documentation and evaluation.

Donnelly-Roark's dissertation, which draws from case histories of two NGO projects in Rwanda and Kenya, describes, an untested concept. However, its arguments are persuasive given the failure of existing approaches to achieve the IDWSSD goals, and the absence of real sustainable and replicable projects. A major constraint to wide adoption of the Donnelly-Roark's approach by donors and governments will be the underlying concept that a degree of control must be lost by the donor or project manager as its design is handed to a community. However, the approach goes some way towards defining the potential role of NGOs as intermediaries in the sector.

f) The International Drinking Water Supply and Sanitation Decade Approach

The parallel development of the IDWSSD approach (the origins of which are described in chapter 2), and the participatory framework approach (described above), indicate the divergence in aid philosophy that took place in the 1980's, and a return by some to the national development planning approaches of previous years. The Decade approach provided a new dimension of vertical programmes with the introduction of National Assessment and Countrywide Water Decade Plans (WHO, 1978). This was reinforced by the International Agencies who strongly promoted the establishing of National Action Committees with Technical Support Teams, and donor coordination committees chaired by the UNDP Resident Representative in each country (WHO, 1981b & 1982a). It also signalled a new influx of technical assistance personnel into the developing world.

The parallel Participatory Framework and IDWSSD approaches in the 1980's is indicative of the divergence in aid philosophy that took place. Some donors, mainly the NGOs, extended the community participation concept, while

others, particularly the bilaterals and multilaterals, returned to the national development planning approaches of the 1960's.

3.4 Linkages and Parallels in Water, and Rural Development Project Designs

There are clear linkages between rural development and rural water projects. Water is an essential element of agricultural production, and is also essential to the well being of the rural population who drive the production.

There are also clear parallels in the development of the approaches taken in the design of rural water and rural development or agricultural projects. In agriculture the trend has been away from the coordinated national and regional programmes of the 1960's, through a phase of integrated rural development projects of the early 1970's, to the pragmatic simple projects, or functional programmes, which are presently in vogue. The present approach provides for simple "interventions" aimed at removing one or two critical development constraints. It is based on local level planning, and the involvement of people in a phased process that improves productivity and local administration. Rural development is seen by most development students as a broad spectrum of activities of which the development of water supplies is but one key element (Lele, 1975). In parallel to this, some donors like the Development Banks are moving back towards special sector projects which very specifically focus on improving productive capacity.

The approach to water sector project design has also moved away from national master plans and national programmes to simpler projects that are designed and implemented at local level with the involvement of the beneficiaries themselves. However, the Water Decade has created an anomaly in this trend. The high degree of interest that has been generated by the Decade has led some donors back to thinking of water sector development in the

context of large national programmes requiring broad planning exercises and a high degree of technical support. Furthermore, this has led back to vertical sector water projects in which intersectoral linkages are not sought. In this respect water projects differ significantly from the majority of rural development projects.

3.5 Project Components - The Present Research Trend in Rural Water Supply and Sanitation

Academics and researchers in the developed world are ~~a~~ important actors in the donor system who have had significant impact on donor policy and project design. A review of contemporary literature reveals that recently the trend in sector research has been directed towards the various individual components of the water and sanitation projects. However, less has been written on how these components are brought together in a holistic programme or project model. The range of these popular research fields is summarized below;

- community participation,
- appropriate technology,
- the involvement of women,
- methodologies for social surveys and feasibility studies,
- monitoring and evaluation methodologies,
- maintenance of non piped water supplies,
- development of training materials,
- health impact evaluation.

Of all these, community participation, appropriate technology and the involvement of women have received the most attention and interest. Conversely, the provision of credit and cost recovery has not emerged as a major research topic of interest.

It is not intended within this thesis to undertake an in-depth literature review of these topics. However, the following pages serve to illustrate the wide scope of project "component" research and literature.

a) Community Involvement

The involvement of communities in all stages of a project from planning to maintenance has been widely researched and discussed as can be seen in the joint World Health Organization (WHO) - International Reference Centre (IRC) Selected Bibliography of Participation in Community Water Supplies compiled by van Wijk-Sijbesma (1979) which lists 145 relevant publications.

b) Appropriate Technology

Similarly the design of appropriate technologies ranging from handpumps to bio-gas digesters has received tremendous attention perhaps as an offshoot of the appropriate technology cult that has grown in recent years. A number of appropriate technology centres and groups have been established around the world including the Intermediate Technology Development Group in London, the World Bank's Technology Advisory Group, and the ↪ Environmental Sanitation Information Centre in Bangkok, all of whom produce staggering amounts of information on topics such as windmills, bio-gas plants, hand pumps and latrines et cetera. This information must be thoroughly confusing to the developing country technician who is the target. The bibliographies of IDRC and IRC; "Low Cost Technology Options for Sanitation" (Rybczynski, 1978), and "Compilation of Practical Solutions in Drinking Water Supply and Waste Disposal" (IRC, 1982), illustrate the wide range of literature.

c) The Role of Women

A great deal has also been written on the benefits and importance of involving women in water supply and sanitation projects. This is illustrated by another IRC publication, "Participation of Women in Water Supply and Sanitation, Roles and Realities" (van Wijk-Sijbesma, 1985), which contains a selected bibliography of some 45 titles.

d) Other Research

Perrett's many publications on social feasibility analysis (1984), typifies the interest in pre-project social surveys. Monitoring and evaluation is discussed at length by Feachem et al (1980), and in two substantial publications of the Organization for Economic and Cultural Development (Miller, 1980. Imboden, 1977), also by WHO (see Annex 1), and many others. The other research areas listed above have also attracted a similar wide range of interest resulting in numerous publications.

When reviewing the range of contemporary sector research two gaps can be seen. First, that little is being written on the overall design of projects, that is, the interrelation of components, the process of developing the water sector in a country, or the relationship between the sector and the broader rural development process. Second, that the vast majority of research is driven by the academics of the donor countries and that little developing country driven operation research that addresses issues constraining the development process is taking place. The major consequence of this is, that there is little useful feed back from researchers to the professionals who design programmes as compared to other sectors particularly in the developed world. This reinforces the compartmentalization of projects.

In 1982 the International Reference Centre for Community Water Supply and Sanitation undertook a major search and review of planning and design literature for the sector. This resulted in the publication of a comprehensive annotated bibliography (Lincklaen-Arriens & Helsing, 1982). Of the 110 primary, and 87 secondary sources cited, 43 dealt mainly with the design or planning of community participation, 52 with evaluation, 48 with technology, 72 with institutional issues, 44 with finance and 43 with training. However, only six references were cited that alluded to comprehensive and dynamic project planning in which the interrelationship of project components over time was analysed. Moreover, of these six documents, two dealt

with general planning theory (Doorn et al, 1978. Emery & Trist, 1965), and two with planning for rural development in which water and sanitation were seen as components (Smith et al, 1980. van Stavern & van Dusseldorp, 1981). The two remaining references were to WHO's Water Decade Publication, "Drinking Water and Sanitation, 1981 to 1990, a Way to Health" (1981), and IRC's own Bulletin Number 10, "The Experience with Sector Studies (Becher, 1977).

The IRC bibliography acknowledges that none of these documents provide adequate guidelines for sector or project planning. Since the release of the IRC Bibliography, a number of other project design guidelines and models have been published, for example those of Glennie (1983), Strauss (1983) and Chandler (1985), these were discussed earlier, however, the comments of IRC still remain valid at the end of the Water Decade.

3.6 Summary and Model for Rural Water Supply and Sanitation Development

This chapter illustrates that historically, the approach adopted by both donors and Third World governments toward the design of both rural and water supply development projects is a product of the prevailing aid philosophies of the time. Furthermore, that the trend in project design is slowly moving away from large, complex initiatives, which were often centrally (or vertically) designed by the experts of the donor community to smaller projects aimed at the removal of specific development constraints and that involve people themselves in their planning and execution, and recognize the constraints and limitations of both the recipient governments and communities. However, present research has done little to assist in developing an integrated model.

From these discussions it is possible to synthesize a preliminary conceptual systems model for rural water supply and sanitation development within the broader context of a rural development framework that embodies the

concepts of simplicity and community involvement, and that defines the most effective roles of the three main systems; donors, governments and people. This hybrid model which is drawn from the pragmatic application of the basic needs approach to rural development, as described by Lele (1975), and the practical experiences of the rural water and sanitation project designers and implementors of the late 1970's and early 1980's, notably Glennie, Strauss, Chandler and Donnelly-Roark, described above, is summarized in table 2 - "Summary of a Conceptual Systems Model for Rural Water Supply and Sanitation Sector Development Based on Contemporary Approaches". However, when applying systems thinking to these contemporary approaches it is clear that not all the elements of the sector system are recognized.

Lele contends that rural development project designers should view development from the perspective of improved welfare, as well as increased productivity, and that priorities and phasing of these intertwined components need to be defined. Furthermore, she argues that projects should not be complex, with too many components, and should sequentially remove direct developmental constraints starting with the most critical. She also qualifies this by stating, that social services, (such as schools, improved water and sanitation) may be secondary priorities.

Lele also stresses that because of limited resources, and in order for projects to be viable and sustainable, popular participation should be mobilized. The perceived role of government, in this model, is a local level catalyst stimulating the local level planning and implementation of rural development programmes. However, Lele concedes that generally, governments' promotional, administrative and technical capacity is weak, and often need great improvement. This should therefore be one of the priorities for donor support in projects. In summary, Lele believes that; productive capacity and welfare services should be improved together in a phased and prioritized process; that projects should be simple and aimed at removing critical constraints; that popular mass

Table 2. Summary of a Conceptual Supra Systems Model for Rural Water Supply and Sanitation Sector Development Based on Contemporary Approaches.

1. Goal and Objective

Improved health and economy through the provision of improved water, sanitation and education in an integrated programme.

2. Inputs, Outputs and Transformation Process

Finance (grants and loans etc) and expertise (consultants and technical assistance etc) which is provided by the donors is transformed into appropriate water and sanitation infrastructure by governments and communities through a process of designing and implementing projects and programmes. The transformation process may be determined by the dominant donor or government model, capitalist or socialist for example.

3. The Systems and Their Functions

a) Donors should provide financial and technical resources to governments in order to strengthen their capacity to undertake development interventions. Specifically, to motivate, mobilize and support communities. They should also coordinate their programmes to ensure overlap does not occur and optimum use of resources. They may advise on sectoral priorities.

b) Governments are responsible for establishing policy, directing and coordinate donor support and creating an environment conducive to development by strengthening local level planning and implementation capacity. This includes motivating and mobilizing communities into self help efforts and providing technical financial and educational support. Government bodies should coordinate their programmes to ensure overlap does not occur and optimum use of resources.

c) Communities should participate fully in planning, constructing, managing and maintaining the water and sanitation systems.

4. Key Concepts for Optimum Interactions Between the Systems

a) Communities should participate in the decision making at all levels of planning and implementation.

b) Projects should be simple and address specific issues, but be set in a broad rural development framework or context and be coordinated with activities in other sectors such as health and agriculture.

c) Furthermore, projects should integrate water, sanitation and education components and be based on the use of appropriate technology and community management in order to ensure sustainability.

99 d) All direct capital and recurrent costs should be borne by the community.

e) Programmes should evolve adaptively from small projects in which the the various components and strategies have been tested.

→ f) Projects should be systematically monitored and evaluated by both the donor and the recipients in order to feed the evolution process.

5. Some Key Actors and Their Perceived Roles

- a) Donor experts should concentrate on training national staff and other institution building activities in order to increase local capacity.
- b) Extension workers should provide the interface between government and communities and be involved in empowering the community to participate fully in development projects.
- c) NGOs should be used by governments to supplement extension workers as intermediary in their communications with communities. That is, as systems boundary spanning mechanisms.
- d) The domestic private sector which is a largely untapped resource, may well be able to play an increasing role in accelerating the development and operations of water and sanitation systems at local level.
- e) Women because of their role as the carriers of water and guardians of family health should be a major focus of mobilization and education campaigns.

6. The Supra Systems Dynamic

As sector development progresses from small scale pilot activities to large scale programmes in an adaptive and flexible learning process, the function of the systems and role of the actors will change over time. For example, the donors role may change from providing intensive technical assistance in training and institution building to simply providing funding. Whereas, the community role may change from being observers of pilot projects to project planners and implementors.

participation is required in order to mobilize sufficient resources and ensure sustainability; that government should play a catalytic role in local level planning and implementation, as governments are often weak in this area, and require strengthening and redirection; and that this should be a focus of aid programmes.

There is evidence that the general approach advocated by Lele has had some successes, particularly with small scale farmers involved in irrigation in the middle income countries of the Mediterranean and Asia, such as Egypt and the Philippines (Korten, 1982. Layton & Salman, 1984). However, Lele fails to fully explore the role of the donor system and its actors.

Briscoe and de Ferranti's recent publication; "Water for Rural Communities - Helping People Help Themselves" (1988), summarizes the trend in project design, away from the top down master plans, and towards involving and empowering people in project planning and implementation, as described in this chapter (Glennie, 1983. Strauss, 1983 and Chandler, 1985). Briscoe (p16-19) states that:-

"Communities should be involved in all stages of water projects. The roles and responsibilities of the community and government should be clearly defined. Government should act as a support to communities, not as the owner and manager of water supplies. The contact between government and communities should be through cadres whose primary skills are organizing and mobilizing communities. Government agencies should fulfill limited but vital tasks of motivation, training and providing technical assistance."

Briscoe qualifies this by also stating (p23-25) that:-

"Within projects there should be a partnership between the public and private sector, cost recovery, often a redirection of the role of government, an increased role for women, and a knowledge of what communities really want and are willing to pay for."

However, like Lele Briscoe fails to fully explore the donor system and its actors. Furthermore, in reviewing the present research trends and project models, a number of common elements emerge as important project components, which are not explicit in the above. These are, the use of appropriate technology, the need for monitoring and evaluation, the need for complementary health/hygiene education and the need of intermediaries. A further omission in these approaches is that the dynamic process of sector development is not given due consideration.

Some of the project models recognize that a development process takes place within an individual project. Glennie (1983), goes some way toward categorizing the stages of this from a project management perspective rather than a development perspective. He also contends that a leap from a pilot project to a national programme can be taken, as was the case in Malawi. But it is unlikely to be universally true. Glennie's stages are first a pilot phase in which technical aspects are tested, and confidence and demand stimulated. Second, a consolidation phase, in which staff are trained and technical standards and procedures established. Third, an expansion phase in which the project is developed into a broad activity (or as Glennie claims a national programme), with government support and policy. Fourth, a maintenance phase into which completed projects enter. This internal project process is also confirmed by Korten (1980), who from a "grass roots" perspective defines three stages in the development of community based projects in terms of increasing community capacity. The stages are; the community learning to be effective; the community learning to be efficient; and the community learning to expand. Both the Korten and Glennie models are valid from their respective vantage points within a project. However, in order to define a broader model for the sector development process within a country, programme or a region we have to look outside the sector.

Rondinelli (1983), asserts that if control oriented

planning and management is ineffective and inappropriate in coping with the complexity and uncertainty of development projects, as is the case in the rural water and sanitation sector (Therkilsen, 1988), an alternative is to view development projects as "policy experiments", and to plan them incrementally and adaptively. Clear project phasing can not always be initially defined. Planning and implementation become an art in which courses of action are based on past experience as well as a realistic understanding of present and emerging conditions. By planning and implementing projects sequentially through experimental, pilot, demonstration and replication phases, problems can be effectively disaggregated and optimum solutions can evolve. This model is particularly applicable to the rural water supply and sanitation sector as it takes into account the need for the development of appropriate technology and a community based delivery system. Rondinelli's definitions of the development stages can be characterized as:-

First, the experimental stage, which are small scale exploratory and risky ventures that are useful in acquiring knowledge, and in finding ways of coping with basic needs. Thus, experimental projects are needed when problems are not well articulated, elements of a problem not well defined, courses of action not explored or their impact known. Second, the pilot stage, in which the applicability of the innovations produced in the experimental stage can be tested in more realistic and typical environments as a prototype for larger scale activities. Experimental and pilot projects often have to be segregated into autonomously managed activities that can provide sufficient resources and protection from external influences to allow them to run their course. Third, the demonstration stage, in which the purpose is to show that the new technologies, methods, programmes et cetera, are better than traditional ones because they increase production or deliver social services more efficiently. Fourth, the replication stage, is where the tested methods and techniques are widely

replicated to provide full scale production or wide distribution of services. From the above we can conclude that the sector development process is likely to be dynamic and that the role of the key sub systems will change over time.

Zimbabwe provides a unique case study in which the model can be tested and compared with more traditional forms of aid and technical assistance. The model should be considered at two levels. First, the design of individual or discrete projects, and secondly, the design of a process or programme of sequential activities that raises water and sanitation coverage or service levels within a developing country.



- o 0 o -

Chapter 4

Rural Development in Zimbabwe

- o 0 o -



Chapter 4

Rural Development in Zimbabwe.

This chapter describes the broad environment of the rural water supply and sanitation supra system in Zimbabwe. It provides a brief description of the geography and post Independence political structure and a detailed review of the socio political and administrative structures of the rural areas, that is the government and community systems. It describes the communities perceived development needs and constraints and elaborates on the Government's post Independence rural development policies and their translation into developmental initiatives. This includes the Rural Reconstruction, Resettlements, Growth Centres and Primary Health Care Programmes. In conclusion the chapter describes the extension programme being established in support of these activities which is an important actor in the Government system and an important systems boundary spanning device.

4.1 General Description

Zimbabwe is situated in south central Africa between the Limpopo and Zambezi Rivers. It is bounded by Zambia on the north and north west, by South Africa on the south, by Mozambique on the east and north east, and on the south west by Botswana. Zimbabwe lies wholly to the north of the Tropic of Capricorn. The area of Zimbabwe is 390,750 sq.kms., about three times the size of England. The population density is approximately 20 people per sq. km., the total population being some 8.5 million people, in comparison the United Kingdom has a density of 240 people per sq. km. The population is growing at some 3.7% per year, the UK. grows at 0.1% per year (World Bank, 1987).

The altitude varies from 360m to 3,600m the average being some 1,000m above sea level. The outstanding physical

feature is the central plateau, known as the highveld, which is about 650km long by 80km wide. On either side of this is the middleveld which is between 600m and 1200m above sea-level. Deep river valleys have split the middleveld areas into great blocks of fine plateau country. The lowveld below 600m comprises a narrow strip in the Zambezi Valley and a broader tract between the Limpopo and Sabi Rivers. Because of the altitude, the climate is sub-tropical. Rainfall is seasonal and occurs between November and March; although between 1982 and 1984 severe droughts were experienced.

In 1980 Zimbabwe gained Independence after ninety years of colonial rule and fifteen years of illegally declared Independence, the last seven of which were plagued by civil war. During the war 27,000 were killed and 850,000 made homeless; the disruption of rural life was considerable (World Bank, 1981). The war was fought over two main issues; the enfranchisement of Africans, and the extent to which Africans could benefit in the countries economic potential, particularly in the patterns of land settlement and farming which was skewed towards the white population. Fighting ceased in 1979 as the various parties reached agreement under the British sponsored Lancaster House Agreement which led to majority rule and African control of the machinery of Government.

Although the new Government inherited an economy with excellent development potential, they were faced with a number of serious problems including; some one million refugees or displaced person needing care, some 35,000 armed troops requiring demobilizing or integrating into a new national army (World Bank, 1981b), and a very high population growth rate (NMPRWSS, 1985), see table 3.

Agriculture is the chief source of income for more than 70 per cent of the population and provides gainful employment in the wage economy for 345,000 people. Even in poor climatic years, it contributes more than one-third of the country's earnings and a substantial share of inputs to the local manufacturing industry. Zimbabwe's rural areas

are characterized by the disparity of its dual agro economic system. The commercial part of the sector comprises some 4,400 large and 8,500 small commercial farms which occupy some 17M ha. of prime productive land concentrated in the highveld. In contrast the communal areas or "communal lands" are occupied by some 700,000 peasant farming households which occupy a similar area of barely marginal land, mainly in the middleveld, under traditional forms of land rights. The communal areas suffer from an unfavourable natural and socio-economic situation inherited from the colonial past, the main features of which are:

- i) high population density with up to 70 inhabitants per sq km, which is rapid increasing. Table 1 indicates the projected growth in the population of communal areas up to the year 2005.
- ii) unfavourable natural conditions, with soils tending to be of marginal character (acid, leached and inherently infertile sands), unreliable rainfall and a mountainous and hilly surface. 52% of the commercial areas belong to the favourable Natural Regions I to III, whereas, 74% of the communal areas lie in the unfavourable Natural Regions IV and V. Natural Regions I to V being a Zimbabwean classification system for land indicating a steady decline of agricultural potential under lowering rainfall conditions.
- iii) subsistence level farming with low production and productivity. In bad years, communal areas are deficient in food;
- iv) limited infrastructure;
- v) limited off-farm employment opportunities.

The economic system of the communal areas is one of subsistence farming, predominantly small farm units, with household sizes usually of 5 to 6 persons who cultivate an area of about 3 ha. and have rights to communal grazing land. Fewer than half of the farming families own a small herd of cattle. Cultivation is almost exclusively by draught oxen. The main crops of the country are maize,

sorghum, millets, groundnuts and cotton (CSO, 1983/84).

Before Independence there was little, if any, investment in the infrastructure or provision of social services for communal areas, or tribal trust lands as they were then known. Unlike many of Rhodesia's neighbouring countries who attracted foreign aid for rural development in the 1960's and 1970's, because of her isolationist policies Rhodesia's rural areas were starved of aid. Table 4 indicates the wide range of needs in communal areas as perceived by its residents. The provision of domestic water supplies is high on this list, especially for women, together with health care. There is also a widely perceived need for the provision or upgrading of infrastructure and support to agricultural production. Low on the list is the desire for sanitation facilities. These findings were the result of a study carried out in 1982 by the UNEP and the University of Zimbabwe's Department of Land Management as part of an environmental study of the Sabi Valley in Manicaland.

The main thrust of the new Government's development strategy was to integrate the communal areas into the mainstream of the socio-economic development of the country. It was intended that the Ministry of Agriculture, Lands and Rural Settlements, together with other ministries and development agencies, should play a pivotal and vital role in this strategy. This developmental strategy was motivated by the desire to redress the imbalances caused by the dualistic structure of the inherited economy.

The foundation and framework for these rural development initiatives was an extension and outreach. This policy is stated in the white paper "Growth with Equity", released immediately after Independence (ROZ, 1981). Government also published volume I of a Three Year Transitional National Development Plan in the following year (ROZ, 1982). The plan provided the broad ideological, socio-economic policy framework and quantitative aggregates for macro economic development. Whereas, Volume II of the Plan, which was finalized in 1986, deals in detail with

Table 3.

Projected Rural Population in 1990, 1995 and 2005
in Communal Areas By Settlement Classification
(from NMPRWSS, 1985).

Settlement type	Population (thousands)			
	1985	1990	1995	2005
Dispersed rural	4481	5008	5659	7555
Growth points & centres	166	246	308	482
Resettlement areas	306	576	852	1146
Model B coops	30	37	45	54
Total	4983	5867	6846	9237

Table 4.

Most Important Rural Development Needs as Perceived by
Mothers and Heads of Households in the Sabi Valley
Manicaland (from, University of Zimbabwe, 1982).

Priority Needs	Mothers %	Household heads %
1 Clinic	28.8	23.1
2 Domestic water	25.9	20.1
3 Domestic water for school	8.1	6.9
4 Improved shopping facilities	7.4	6.7
5 Improved roads	4.4	5.8
6 Improved bus service	4.3	5.3
7 Improved postal facilities	0.4	2.9
8 Improved primary school	2.6	2.5
9 Access to secondary school	1.8	3.9
10 Grinding mill	2.8	2.3
11 Food aid	2.5	3.5
12 Water for livestock	2.1	1.7
13 Water for irrigation	0.1	1.3
14 Transport of produce	2.1	3.3
15 Seed	1.4	1.6
16 Adult education	1.4	0
17 Creche\nursery	1.6	0.5
18 Sanitation facilities	0.8	0
19 Roofing materials	0.8	0
20 Other categories	1.0	8.6

sectoral and ministerial development issues at the micro level (ROZ, 1986). The plan seeks to coordinate development activities, policies and measures; mobilize and effectively deploy economic, financial and manpower resources for efficient growth development and distribution; enlist the support and active participation of all Zimbabweans in the development process; and to encourage investors at home and abroad to support and participate in the development of the country. The development strategy embodied in the plan asserts that planning is seen as an on-going process necessitating the formulation of annual development plans which will use the budget as the major instrument for planning implementation.

Government does not have a water and sanitation policy. However, a health policy is clearly stated in a white paper "Planning for Equity in Health - A Sectoral Review and Policy Statement" (MOH, 1981). The theme of which is the correction of social inequity in health care through the transformation of the MOH from an urban curative body to a rural preventative service, mainly concerned with primary health care. The provision of water and sanitation to the rural poor is seen as an integral part of the primary health care package. Emphasis is also placed on self help and community participation and integration of other activities such as the production of foodstuff.

Supported by a number of donor agencies who rallied to assist after Independence, as demonstrated in the "Zimcord" pledging conference in 1980, Government quickly launched a series of activities aimed at resolving these immediate problems; providing basic needs and establishing social equity, these included the Rural Reconstruction Programme, the Resettlements Programme, and the establishment of rural growth points and centres. Government also launched a primary health care drive and a Consolidation of Villages programme. The foundation and framework for these rural development initiatives was the establishing of a receptive socio political structure through which communities could be mobilized into participating in their own development.

At this point we should examine in more detail the administrative, socio economic, planning and extension structures promoted and established by Government in support of the rural development programme.

4.2 Legislative and Administrative Structure

The post-Independence legislature consists of the President and Parliament, which comprises a Senate and a House of Assembly. The President is the Head of State and the Commander-in Chief of the Defence Forces. He is elected by the Members of Parliament and holds office for a period of six years, after which he is eligible for re-election for one further period of office. There are 40 Senators who are chosen by a combination of electoral colleges, the Council of Chiefs and by Presidential nomination. The House of Assembly has 100 members, 80 of whom are elected by voters on the common voters' roll and 20 of whom are elected by voters on the white voters roll. Parliament has a maximum life of five years, after which it is automatically dissolved. The ruling ZANU PF political party was re-elected to lead Government for a further five year term in 1985 by an overwhelming majority.

Zimbabwe is divided into eight provinces; Mashonaland East, Central and West, Midlands, Manicaland, Masvingo (previously Victoria Province) and Matabeleland North and South. Each of the provinces is subdivided into districts of which there are fifty five; districts are then further subdivided into wards and villages. In the previous administration, there was a duality in the local government system related to land classification. Commercial farming areas were generally administered through Rural Councils, whereas the then Tribal Trust Lands now known as Communal Areas, were administered by District Councils. Local Government reform has led to the present amalgamation of rural and district councils to form Rural District Councils, which are democratically administered by elected councillors who are advised by Government appointed

District Administrators and their supporting personnel.

Since Independence, emphasis has been placed on decentralizing much of central Government's administrative functions to provincial level, where an elected Provincial Administrator, supported by the Ministry of Local Government Rural & Urban Development, guide and coordinate the development process in each province. Each of the central sector Ministries, that is, Health, Energy & Water Resources Development et cetera, have established almost operationally autonomous provincial offices so Ministry headquarters' functions are becoming administrative and advisory. Government has also been instrumental in establishing a socio political structure through which, theoretically, the planning and administrative functions of Government can communicate with people. The major actors in the Government system are; the line ministries, local government, and the extension services.

4.3 The Socio Political and Planning Structure

The basic unit of society is a kraal which may contain up to 20 families; a number of adjoining kraals make up a village, on average some thirty or so villages make up a ward. At grass roots level, Government has encouraged each village to form a Village Development Committee (VIDCO) to represent and present the areas' development needs and priorities to a higher level. VIDCO representatives come together at ward level in a Ward Development Committee (WADCO) and report up to District and Provincial Development Committee levels. In practice there is a dichotomy between the traditional village leaders or "headmen" and the democratically elected representatives.

Theoretically the interface between the Government system and the socio political structure or community system is established at all the above levels: Government extension workers such as Village Health Workers (VHWs) are represented at the VIDCO, Health Assistants at the WADCO. Government professional and technical staff from sectoral

Figure 8.

Diagram Showing the Organization of the District Administration and the Linkages Between Local Government and Community Structures (from Dunets, 1985).

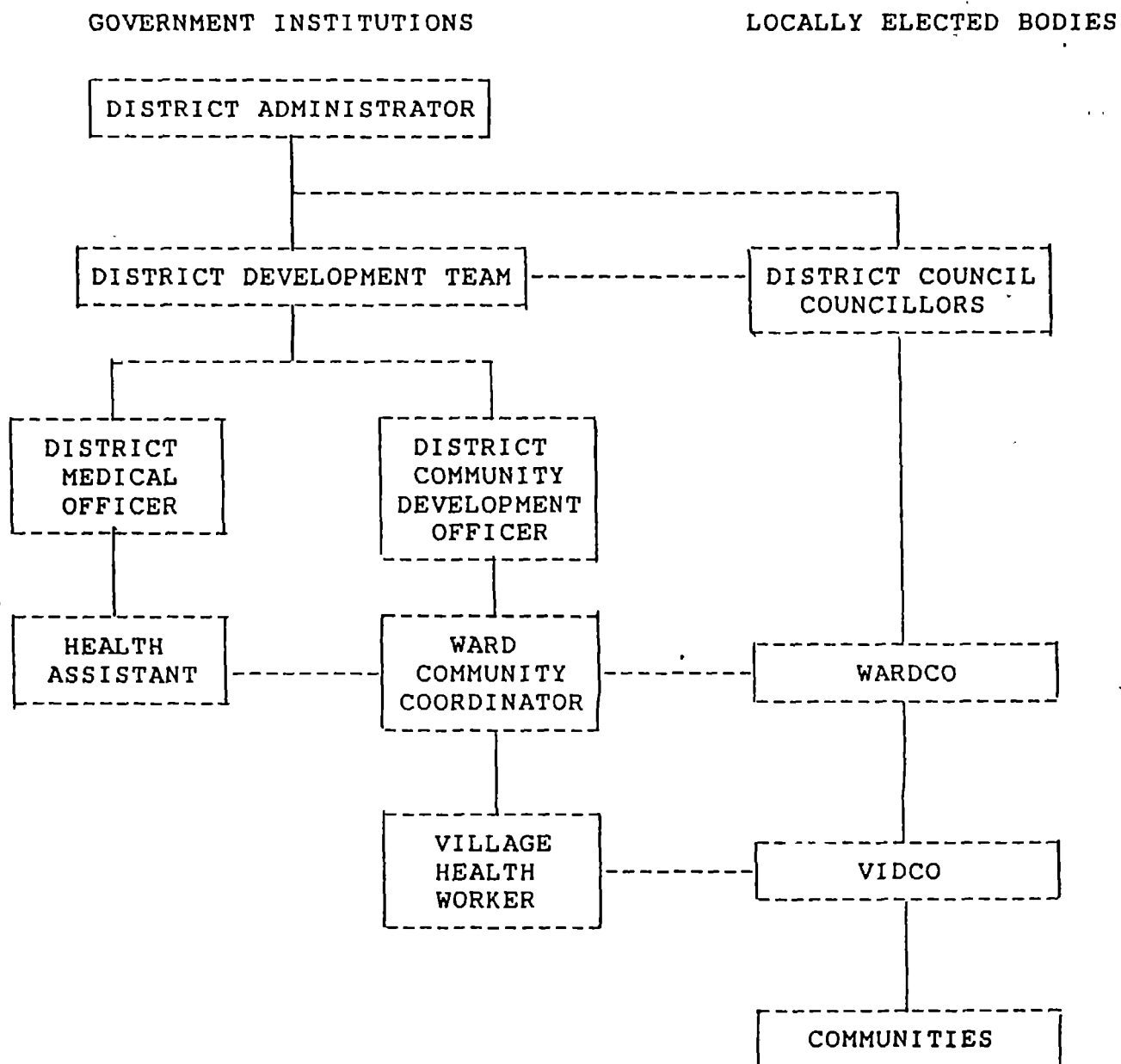

Ministries support the district and provincial level development committees through Technical Support Teams. Figure 8, depicts the relationship between local government and community structures (NAC, 1983).

Theoretically, the development needs and priorities, as perceived at grass roots level, are made known to central and provincial Government through the VIDCO/WADCO structure. These needs are rationalized and consolidated at district level by the District Development Committees, assisted by the Technical Support Teams, into integrated District Development Plans. District Development Plans, in turn, are consolidated at Provincial level into integrated Provincial Development Plans and then into the National Development Plans. Information regarding the rationalized National and Provincial Plans is then passed down through the structure to village level (World Bank, 1981a). Key actors in the community system are; traditional leaders, elected representatives and people themselves.

4.4 Extension Services

The foundation of the Zimbabwe rural development strategy is outreach and extension. Table 5 shows the diversity and scope of the planned extension force, which is one of the main actors in the Government system. One of the major strengths of the extension worker cadre is the willingness and ability to coordinate and support each others' activities at grass roots levels. A number of these extension staff are involved in the promotion, and supervision of water supply and sanitation projects as an integral part of their broader rural development duties and efforts (NAC, 1983. Lenneiye & Mufta, 1983). Amongst these are:-

a) Agricultural Extension Workers

Agricultural extension workers are employed by AGRITEX, which came into existence in October 1981 following a post Independence merger of the Department of Conservation and

Table 5.

Range of Extension Workers in Zimbabwe (from Lenneiye & Mputa, 1983)

Category	Level of deployment	Number of posts
1 Agricultuarl extension workers	Village	1300
2 Community development workers	"	500
3 Home economics demonstrators	"	450
4 District literacy coordinators	District	100
5 Village health workers	Village	3500
6 Malaria control field orderlies	District	150
7 Health assistants	"	1200
8 Cooperative advisors	"	300
9 Resettlement officers	"	50
10 Village court messengers	Village	15000
11 Local gov'n't promotion officers	District	220
12 Village dev'ment promotion officers	Village	15000
13 Youth promoters	District	240

Extension (CONEX) and the Department of Agricultural Development (DEVAG). CONEX had served the large and small Commercial Farmers while DEVAG had been formed for Communal Lands extension services. The merger produced the Department of Agricultural Technical and Extension Services (AGRITEX) to provide extension service to all farmers (commercial, communal, resettled, cooperatives et cetera) and to be responsible for agricultural land use, planning and the conservation of both soil and water. AGRITEX activities, therefore, have great potential impact on rural development and the nation's overall socio-economic development. AGRITEX goals were formulated in concurrence with Government's policies on agriculture development as stated in Growth with Equity (ROZ, 1981. p26-27).

"To cooperate with the various departments of Government associated with our work in the field, in order to ensure a team approach to the needs of the rural areas and their occupants".

These goals characterize the concept of integrated rural development adopted by the post colonial administration. The job description of the AGRITEX field worker involves working with farmers to plan programmes, provide training, and to evaluate and assess their progress. They are also expected to report on and to coordinate with agricultural extension services, as well as organizing field days and shows. They also have a well defined role in the development of water supplies for small scale agricultural use.

b) Extension Workers for Lands, Resettlement and Rural Development

The Ministry of Lands, resettlement and Rural Development employs two categories of extension workers; Resettlement Officers and cooperative advisers. Their functions are summarized below (MLGRUD, undated):

i) Resettlement Officers implement resettlement programmes by coordinating all relevant agencies involved in the

various aspects of resettlement - land use planning, land demarkation, land allocation, land tenure et cetera. They also oversee the movement of people from communal to resettlement areas, and supervise communal activities among settlers. For example; cattle dipping, and control of grazing and woodlots. Resettlement officers are also charged with the development of water supplies for both domestic and agricultural use and provision of sanitary facilities in the resettlement areas.

ii) Cooperative advisers undertake the following tasks. They encourage the formation of cooperatives by explaining their advantages and correct procedures. They assist cooperatives with production and marketing problems, and advise cooperative committees on how to conduct their affairs, especially with regard to finances, laws and meetings. When required, they also run training courses for cooperative members and the development of water supplies.

c) Extension Workers for Community Development

The Ministry of Community development and Women's Affairs has three categories of extension workers; Community Development Workers, Home Economics Demonstrators, and District Literacy Coordinators. Community Development Workers and Home Economics Demonstrators are considered to form the basic team for community development extension. They mainly undertake the following:

- i) The promotion of the advancement of women and equal opportunities through; holding seminars for communities on the legal status of women, identifying women's needs, making communities aware of discriminatory practices and mobilizing women for such activities.
- ii) Assisting communities in formulating projects through; identifying problems, mobilizing and organizing community resources, calling upon available Government resources, and encouraging the formation of cooperatives.
- iii) Working with communities in the implementation and

evaluation of projects, including the development of income-generating activities (eg. uniform-making, poultry, fishing, rabbit and pig keeping, vegetable gardening, making sisal roofing sheets, savings clubs and handicrafts et cetera). They also promote construction of infrastructure (eg. wells, latrines, foot-bridges, community centres and pre-school buildings), and the development of human resources through adult literacy and pre-school education.

iv) Mobilizing communities in health improvement activities. For example; improving water and sanitation, nutrition and food, maternal and child health and spacing.

v) Community training through; assisting communities in identifying training needs, advising communities of courses in the area, and organization of courses on health, home economics, basic planning and management et cetera.

d) Health-Related Extension Workers

The Ministry of Health employs two categories of extension workers, Health Assistants and Village Health Workers, who are very closely involved with the implementation of rural water supply and sanitation.

i) Health Assistants are primarily concerned with the maintenance and improvement of public health standards in the community. They deal with issues related to water and sanitation - especially protecting water wells, and constructing pit latrines in the rural areas, they also advise on the disposal of other wastes. They report communicable diseases and give lectures on how to prevent these, especially tuberculosis, leprosy, schistosomiasis and malaria. They work closely with mobile professional health teams in the prevention of these diseases. They also are involved in the inspection of commercial premises and foodstuff to ensure adequate standards of hygienic practices in the preparation and storage of food. Health Assistants also form a part of the rural health service team and are involved in the EPI programme, the National

Health Information System and the notification cases of some "notifiable diseases".

ii) Village Health Workers assist the community in health related matters. They are also village health educators, and are therefore fundamentally involved in disease prevention. Other functions include giving advice on well protection, latrine construction, home hygiene, and immunization as well as treating minor illnesses such as headaches, fever, diarrhoea, coughs, wounds and scabies, and the referral of serious illness to the rural clinic.

e) Other Extension Workers

Two other categories of extension workers are involved in rural water and sanitation, Local Government Promotion Officers and Youth Promoters.

1) Local Government Promotion Officers (LGPOs) are employed by MLGRUD. The current staff of some 240 LGPOs are all drawn from the ranks of ex-combatants. They perform both an administrative and political function extension function. The LGPO's are involved in working with District Council Committees on specific issues, promoting the system of a unified local government structure and the promotion of human resource development. They also work with other ministry personnel in community studies and development activities including the promotion of self-reliance. They help restructure local organizations to bring about development, and to inform people of available services in order to encourage self-help schemes. A major function of the LGPO's is to coordinate their activities with other district programmes.

ii) Youth Promoters. Youth promoters attached to Ministry of Youth Sports and Culture have a similar socio-political function, but focussed on the youth of the communities. They live and work at the grass roots level, and are involved in the mobilizing of local youth into brigades and

to initiate and supervise youth projects. They identify the problems of youth, maintain vigilance and inform Government of the security situation. They also mobilize youth and cultural groups for national celebrations, festivals and rallies, and arrange sporting and recreational activities. A secondary function is to encourage the formation of fund-raising committees.

One of the more striking elements in the job descriptions of these extension workers is the overlap in their role of promoting local level development, a major aspect of which is water and sanitation. However, the coordination of their activities with each other is not high on the list of their priorities (Lenneiye & Mupta, 1983. Samset & Lenneiye, 1987).

4.5 Rural Development Policy

The Zimbabwe Government's commitment to rural development and reconstruction led to the launch of a series of interlinked development initiatives amongst which was the concept of a National integrated hierarchical system of settlements that would extend down from existing urban infrastructure into rural areas in order to redress urban/rural and commercial farmer/peasant farmer disparity (MLGTP, 1983). These development initiatives and programmes included; rural reconstruction, the establishment of rural growth points and service centres, the establishment of resettlement areas, and more recently the implementation of a villagization or settlements rationalization and consolidation Programme. In each of these initiatives which call for a high degree of interaction between the Government and community systems, the provision of water and sanitation were integral components. Furthermore, the supporting donor played a major role in shaping policy and implementation strategy.

a) The Rural Reconstruction Programme

During the protracted liberation struggle, which

consisted mainly of rural guerilla warfare, much of the rural infrastructure was deliberately sabotaged or fell into disrepair as many of the rural population were concentrated in Protected Villages or migrated to urban centres. After Independence, this migratory population returned to their original rural homes, and Government launched a programme of infrastructure reconstruction that included the repair of hundreds of water points, mainly boreholes and the reconstruction of many kilometres of roads and the repair of thousands of cattle dip tanks. The work of reconstruction was undertaken by the District Development Fund (DDF), a parastatal body controlled by the Ministry of Local Government, Rural and Urban Development (MLGRUD) that had evolved from the pre-Independence "African Production & Marketing Development Fund". Before Independence the communal areas, or tribal trust lands, as they were known, had received little attention from the Rhodesian Government and much of the infrastructure (what little there was), had been developed by individuals or community groups.

This programme attracted some of the first inputs of bilateral grant aid to Zimbabwe. The aid was directed at both rehabilitation, and the building of institutional capacity within DDF through an expanded training programme. One of the main supporters of the reconstruction programme was the Norwegian bilateral donor aid agency NORAD. Most of the reconstruction is now complete, DDF's capacity has been substantially increased and its sphere of activity has changed to new development work including rural water supplies and emergency alleviation of the severe drought during 1983 and 1984, this was mainly achieved through the development of well sinking activities and borehole drilling supported by various donors including UNICEF and NORAD. DDF also play a leading role in the maintenance of existing water points in Communal Areas. The reconstruction programme was the precursor to the present rural development programme.

b) Growth Points & Service Centres

Work to develop the Rural Settlements Strategy was commenced shortly after Independence in an effort to bring to the people in the communal lands, those services and opportunities for economic activities that were lacking, and to offer them a chance to participate in the development process of the nation (MLGTP, 1983). The strategy was hierarchical and had four tiers, that is the development of; resource based growth points, district Service Centres, rural service centres and business Centres.

The scope of facilities and intended development was highest at the top of the hierarchy. A total of 476 centres in district council areas throughout Zimbabwe have been selected in accordance with specific criteria, and in consultation with local representatives. Most of the centres are currently very small, and likely to remain so during the next 20 years.

Of the 476 centres, the majority are rural service centres. There are 52 district service centres and 8 growth points, and an additional 3 centres being both district service centres as well as growth points. Every district council, 55 in all, has a district service centre. The base population in the centres is probably about 166,000 or only 3.5 per cent of the population in the communal lands (in 1985). By the year 2005, the population in the centres is estimated to have reached almost half a million people. This represents some 5.5 per cent of the population of the communal lands. A growth point is defined as a centre with an identifiable resource base capable of stimulating specific production and marketing activities and whose exploitation led to rapid and sustained growth with development.

District Centres offer similar but higher level services to those offered by the rural service centres. They are, in addition, the administrative capitals of their districts, and, in a way, coordinate and integrate the services available at the lower order centres in the

district. A Rural Service Centre is designed to integrate the functions of the lower order settlements (consolidated villages and business centres). As a general rule, each service centre services up to 10,000 people, none of whom will have to travel more than 20 kilometres to the nearest service centre. In addition, it is, in most cases, be the headquarters of the Ward Development Committee. Business Centres are small commercial centres which cater for the daily needs of the local people. As retail centres, their total number and the distance between them depends on the size and spread of the consolidated villages, and the income generated in their service area.

For each level of resource centre, one of the fundamental services to be provided is water and sanitation which is estimated to cost more than 35% of the total capital investment (MLGTP, 1983). The planning of this exercise is being undertaken by expatriate consultants with donor funding and support.

c) Resettlement Areas

Since Independence, part of the large scale commercial farming areas have been, or is in the process of being, converted into resettlement schemes, and to a lesser extent, Model B farming co-operatives. It is currently estimated that about 12 per cent of non-urban rural council areas, or 14 per cent of the large scale commercial farming area, has been set aside for resettlement.

The Resettlement Programme is an ambitious activity involving a series of investments in different areas or sectors. Due to a number of constraining factors, the programme has got off to a relatively slow start. Originally, it was planned to settle some 162,000 families, or between 850,000 and 900,000 people, over the 3-year transitional development plan period up to and including 1984/85. Currently, it is estimated that only some 188,000 people, or a fifth of the planned number, have been resettled in 63 resettlement schemes, and 31 Model B Co-operatives. Due to the difficult financial situation, it

is considered unlikely that programme implementation could be drastically accelerated in the near future. If the programme is continued in its present form after 1985, the target of settling 162,000 families could well be extended to a later point in time. Government identified three models for the resettlement of under utilized commercial farm or vacant land adjacent to Communal Areas (MLRRD, undated):

Model A: Intensive village settlements with individual arable allocations and communal grazing areas.

Model B: Intensive settlements with communal living and cooperative farming. In this model, all activity is based on the community with cooperative structures and management.

Model C: Intensive settlement combined with a central estate farm. This model incorporates a central core estate which provides certain services to farmers and to which farms will contribute labour. Usable land and livestock are individually owned, grazing in communal areas.

The type B model is designed to meet the needs of young people inspired by the ideology of collective living and will also facilitate refugees and displaced persons (MALRS, undated).

The resettlements programme is strongly supported by the British bilateral donor aid agency ODA, who fund the purchase of private commercial farms onto which the communal area peasants are resettled. As part of this package ODA also fund a technical assistance team, and a borehole drilling operation based in MEWRD who are responsible for developing domestic water sources in these areas. Like the growth points and service centre programmes, the development of water and sanitation in the resettlement areas will take up a large percentage of the capital costs (MEWRD, 1984/87).

d) Consolidated Villages

Consolidated villages are the lowest and smallest form

of settlement in the settlements hierarchy and are the major focus for most community development projects and programmes. The concept of consolidated villages emanated from an analysis of the existing structure of peasant and commercial farm settlements which are relatively dispersed and isolated. The Government's objectives in establishing consolidated villages are: to reduce the cost of infrastructure development; to facilitate the exchange and propagation of innovative ideas; to release additional land for agricultural development; and to encourage the evolution of community approaches to communal problems.

At the present levels of production, the centralized villages may have no direct role on industrial decentralization. They, however, will encourage the development and expansion of industries at higher order settlements through increased demand for agricultural inputs and services and also the increased supply of unprocessed agricultural commodities. The restructuring of present farming systems together with the improved accessibility to the new socio-economic infrastructure, is designed to help reduce the volume of rural-urban migrants.

As foci for development activity in the rural areas, and with the help of the Village Development Committees, the Centralized Village Settlements will facilitate the consolidation of small dispersed farm units into larger agricultural and economically viable units. Government has identified a number of mechanisms and instruments to be used in Village Consolidation:-

1) Delineation of Village Boundaries; This exercise has already started through local government delineating village boundaries for voting purposes. The exercise is being conducted in such a way as to coincide with the Village Development Committees. What needs to be added then to this administrative village boundary is to make sure that all villagers have their fields and grazing area within the confines of their administrative boundary. This then calls for the extra expertise of AGRITEX and the

members of the local Village Development Committee. It is emphasized that the Government Agencies should only assist and leave the initiative to the local people or community.

ii) Consolidation of Residential Areas; This activity calls in the expertise of the Department of Physical Planning, AGRITEX, DDF and the Village Development Committee. It should be noted that consolidation of Residential Areas does not imply resettling the whole village on one central place, but implies a certain minimum resettlement of those people who might be presently settled in an area that would be demarcated grazing or arable, or presently settled outside the confines of their delineated village administrative boundary.

iii) Consolidation of Arable and Grazing Lands; This would be achieved through AGRITEX, Local Government, Ministry of Lands, Resettlement and Rural Development, and the Local Village Development Committees.

iv) Consolidation of Reserved Lands; This would be the responsibility of Physical Planning, AGRITEX, Lands, Resettlement and Rural Development, Natural Resources and the Village Development Committees. Government has emphasized that for the whole process of consolidation to succeed, there is a need for a co-ordinated approach by the responsible agencies (ROZ, 1986). The Ministries of Community Development and Women's Affairs, together with Local Government, have a crucial role to play especially in the mobilization of rural households. Also, total participation and local initiative of the rural households is an absolute must, if this process is to succeed.

4.6 Summary

The post Independence rural development environment in Zimbabwe can be characterized by the Governments systems structure and stated policy, and the translation of this

policy into socio political and administrative reforms, and development interventions. In summary:-

The main thrust of Government's policy is to remove the disparity in the communal lands created by the previous colonial administration, this policy is translated into reality using three main strategies. Firstly, the empowerment of people to participate in their own development. Secondly, the drive for land reform and agricultural improvement, and thirdly, through the provision of basic social services. Through the decentralization of the planning process to district level, and the establishing of structures such as village and ward development committees, Government is enabling communities to become involved in determining their own priorities and in the implementation of development activities. The resettlement programme in which residents of the overcrowded communal areas are resettled in commercial farms that are purchased with donor support. The developing of rural growth centres are seen as the main instruments of land reform, and the primary health care programme is seen as a major vehicle for providing basic needs (ROZ, 1986).

A key strategy in the delivery of these initiatives is an extensive outreach programme which is being established by Government. The extension services fall into four categories of activity; agriculture and resettlements provided by AGRITEX and resettlement workers; primary health care provided by health assistants and village health workers; womens and community development provided by community development workers; and socio political development provided by local government promotion officers and Youth Promoters. Within both the primary health care programme and the resettlements programme, the provision of water supply is seen as an essential component.

Sanitation and health education are also very much a part of the broad primary health care strategy. Women's development is also seen by Government as an essential component of a broader rural development strategy as demonstrated by the establishment of the Ministry of

Community Development and Womens Affairs (World Bank, 1988). Therefore, the political and administrative environment being developed in Zimbabwe would seem to be conducive to the model of integrated rural water supply and sanitation projects described earlier. That is, Zimbabwe is developing the capacity for decentralized planning and the involvement of people in the planning process.

However, there are a number of constraints to the development process that can be seen. Rural population growth is high, more than 3%, and in the longer term threatens to overwhelm the limited resources available. The resettlements, rural development, and primary health care programmes are large, complex, and centrally designed programmes that are proceeding much more slowly than expected, due in part to overlapping responsibilities of the executing agencies involved and the influences of the supporting donors. Governments decentralization process is also proceeding much more slowly than expected, and the administrative and planning capacity at district level is weak and not fully able to provide the perceived interface between the Government and the community systems. The extension services are also weak and inconsistent due in part to overlapping functions, and lack of coordination at community level (ROZ, 1986 & 1988). Good cases in point are the village health workers of the MOH and the community development workers of the MCDWA who have a remarkable number of overlapping functions, for example, the development of wells and sanitary facilities in a village environment. All this is exacerbated by the externalities in the supra systems environment of extensive drought between 1982 and 1985, and the armed political conflict between ZANU and ZAPU, the post Independence tribally based political parties.

At this point we know much less about the dynamics of the community system other than it can be characterized by the dichotomy between the tradition social structure topped by village chiefs or headmen and the new democratically elected leadership which includes representatives in

village and ward development committees. The development of a better understanding of the role of the community in the water sector is an important feature of the later case studies.



- o 0 o -

Chapter 5

The Water and Sanitation Sector

in

Zimbabwe

- o 0 o -



Chapter 5

The Water and Sanitation Sector in Zimbabwe

This chapter reviews the status of the water and sanitation sector in Zimbabwe. It describes water and sanitation coverage and service levels in rural areas, and the ability and willingness of rural people to pay for these facilities. Local research and appropriate technology development and its impact on the development of the sector is also discussed. The chapter continues by describing the structure of the Government system in the sector, particularly, the overlapping responsibilities of the numerous ministries and other actors. In conclusion, the range of donors supporting water and sanitation development in Zimbabwe's is reviewed.

5.1 Water and Sanitation Facilities and Use in Communal Areas

Water development in Zimbabwe exhibits extreme inequalities of access as a result of previous national policies. Whilst in urban areas there is virtually complete provision of improved water supplies (approximately 70% of which have access to household connections), in CAs only one third of the rural population have access to an improved water supply. Of these piped connections serve under one per cent of households. The distribution of households with access to the improved supplies that do exist is evenly spread within the CAs (CSO, 1983/84).

Wells account for just under half of all wet season sources and 38% of dry season sources. Approximately one fifth of the CA population is perennially dependent upon borehole water. Approximately 95% of the population in CAs have at present no access to piped supplies. Water

collection studies carried out during the preparation of the NMPRWSS (1985), indicate that there is a remarkably eclectic pattern of water usage in CAs (see table 6). Water collection is the task of women and children and is a domestic chore of considerable proportions, particularly in the dry season. The mean distance to all sources varies from between 0.7 kilometres in the wet season to just under one kilometre in the dry season. The total average time spent, by all water carriers per household per day, is estimated to be as high as 152 minutes in the dry season.

Mean per capita water use at the homestead for all observed sources is approximately ten litres. This ranges between seven and sixteen litres per capita per day according to source type. However, proportions of water usage by activity are highly seasonal and vary by region. The NMPRWSS (1985) studies indicated that in March (Autumn) just under half of all the collected water was used for personal and domestic hygiene and that the remainder was spread among a variety of uses; cooking and drinking (26%), clothes washing at home (16%), garden watering (3%) et cetera. Whilst in September (Spring) over a third of all water from communal standposts was used for garden watering, that is, production. Rivers are the main source of water for clothes washing and are used by 41% of householders in the wet season and 34% in the dry season. Garden watering is a major water use and approximately 70% of CA householders water gardens, many over considerable periods of time with relatively large quantities of water. Of the 60% of rural householders who own cattle, roughly two thirds water their cattle at rivers for most of the year.

Only seven per cent of rural CA households have Ventilated Improved Latrines (or Blair Ventilated Privies, referred to here as VIP latrines), while 22% have access to some facility for human excreta disposal. It is estimated that approximately 15% of rural households have access to adequate sanitation (CSO, 1983/85. NMPRWSS, 1985), see table 7.

Table 6.

Range of Locations from Which Domestic and Drinking Water is Obtained in Rural Areas by Traditional and Improved Sources (from NMPRWSS, 1985).

Source	Wet season %	Dry season %
IMPROVED SOURCES		
Household tap	0.9	0.8
Communal tap	4.6	4.8
Protected well	7.4	6.3
Borehole	19.0	26.2
Protected spring	0.7	0.6
UNIMPROVED SOURCES		
Unprotected well	41.4	31.4
Unprotected spring	7.0	7.5
River	10.5	9.2
Dam	1.6	3.5
Rainwater collection	0.2	0
Sand abstraction	5.5	8.3
Other	1.3	1.5

Table 7.

Distribution of Sanitary Facilities by Province (from NMPRWSS, 1985).

Province	Sanitation Facilities Available to % of Households				
	Flush Toilet	Blair Vented Latrine	Traditional Pit Latrine	Access to communal Latrine	No Facilities
Manicaland	1.0	10	28	3	58
Mashonaland Central	2.0	9	13	0	76
Mashonaland East	0	3	15	5	76
Mashonaland West	0	6	5	0	88
Matabeleland North	0	2	14	1	83
Matabeleland South	0	1	5	20	72
Midlands	0	6	7	0	87
Masvingo	0	10	0	2	77

Observational studies indicated high levels of usage among adults although instances were recorded, when intra-familial avoidance customs, seen at their extreme in father-in-law/daughter-in-law relationships, limited full adult usage. Low levels of latrine usage among children is apparently a problem. Just under a quarter of all latrine owners interviewed indicated that their children did not use the latrine. Also 34% of households stated that their children only started to use the family latrine at age five or above. Latrines are also used as bathrooms and for the disposal of waste water. VIP latrine ownership is influenced by educational status, and wealth. If proposed programmes are to reach entire communities there is clearly a need to develop effective promotional activity and community organizations whereby the benefits of involvement in a latrine programme are shared more equally (NMPRWSS, 1985).

The development of VIP latrines should of course take account of community preferences alongside technical and health considerations and it seems that the Blair latrine fulfils these criteria. Double facilities are a cultural preference in much of the country but it is one which householders rarely choose to pay the additional cost to fulfil and families develop their own single use protocol.

The patterns of water use and types, and distribution of water sources have significant effect on water sector development strategy. For example:-

- i) Emphasis on improving and protecting existing wells would immediately improve water quality at low capital costs.
- ii) Increased dry season dependence upon boreholes, particularly in the drier provinces, indicates the fundamental importance of borehole development as a back up to well development. Also, although customary use of boreholes for cattle watering is infrequent (only five per cent of households who watered cattle used boreholes), but boreholes appear to be the major fall-back resource in

times of drought for cattle, as they are for humans, and are critical for this reason.

iii) Improved supplies for garden watering are, however, not a widespread priority needs in CAs, since the proximity of gardens to rivers means that there is at least some access to water. Problems posed by the need to distribute adjacent land equitably, and the need for community management of these new development opportunities, limit the use of water from improved supplies for garden watering.

iv) Many of the prominent diseases related to water and sanitation are water-washed, including diarrhoeal, skin and eye disease, and a reduction of the disease load can only be expected once a greater proportion of water is used for personal hygiene.

v) Use of river water for clothes washing and garden watering, despite the provision of improved sources, is a further limitation on the potential for disease control, particularly in the case of schistosomiasis.

vi) The eclectic pattern of water use means that even communities with improved sources have considerable contact with polluted sources.

vii) Lack of integration of water and sanitation provision with complementary health education limits potential health improvement from these facilities.

viii) The immediate benefits to be reaped from water and sanitation projects is the release of women and their time from the water carrying burden to other productive activities, and the provision of additional water for productive use and improvements in the quality of life.

5.2 Appropriate Technology Development

In the early 1970's, before Independence, the Blair Research Laboratory (the research arm of the Ministry of Health and one of the main actors in the government system), embarked on a new course, the control of schistosomiasis through physical interventions,

particularly provision of appropriate excreta disposal systems. Prior to this it had had been primarily engaged in malaria and schistosomiasis control research using conventional techniques involving chemicals and insecticides. The new research initiative eventually led to the development of the "Blair Latrine", or Ventilated Improved Pit Latrine (VIP).

The Blair Latrine design incorporates a ventilation pipe which controls foul odours in the structure and hence fly breeding. The latrine is also structurally stable and hygienic. By the late 1970's, the Blair Latrine had become entrenched in international low cost sanitation theology and adopted by a number of countries throughout the developing world and significantly the Blair Latrine had become fully institutionalized in Rhodesia; this was carried over to Zimbabwe after Independence (Morgan, 1986).

Before Independence, the Blair Research Laboratory also became involved in the development of a low cost PVC hand pump, the "Blair Pump", for use in shallow wells in rural areas. Blair staff worked closely with a local PVC manufacturer and fabricator "Proderite" who adopted the design and undertook production on a commercial scale. To date, some 3,000 pumps have been installed.

Post Independence, the Blair Laboratory has continued and accelerated its research in this field. This has led to the development of the "Bucket Pump" and the improvement of a hand augering rig for the installation of tube wells. Blair has also been involved in the improvement of the Bush Pump. This pump (a hand operated piston pump) was first developed in Rhodesia in the 1930's by Murgatroyde, an engineer working in local government. Since then, some 10,000 or so pumps have been installed on wells and boreholes throughout Zimbabwe by the DDF and MEWRD with little modifications from the original design. Although the pump has given sterling service, it is difficult to maintain at community level as it requires shear legs and block and tackle to lift the rising main in order to access the foot valve (Morgan, 1986). Blair staff have recently

improved the Bush Pump design in line with the VLOM (Village Level Operations and Maintenance) concept emanating from the World Bank UNDP Hand Pump Testing Project (Arlosoroff, 1987).

This history of appropriate technology and techniques, combined with the isolation imposed by the sanctions in the 1960's and 1970's following Rhodesia's Unilateral Declaration of Independence, has led to Zimbabwe having a few locally developed technologies that have to a great extent been institutionalized. The great technology debate that rages in other developing countries does not exist or has been dissipated in Zimbabwe. This has allowed more energy to be directed into other components of the sector. Furthermore, the technologies and techniques have become standardized and familiar to both extension staff and the communities themselves.

In the rural areas of Zimbabwe, the construction of deep wells, the upgrading and protection of shallow wells, and the protection of springs (ie. construction techniques rather than technologies), have over the past thirty years or more have also become institutionalized.

It is paradoxical that prior to Independence Rhodesia was perhaps one of the most advanced countries in Africa with regard to the development of appropriate water and sanitation technologies for rural areas. However, coverage levels were particularly low due to the policies of the colonial administration. Even so, it can be justifiably claimed that the local research and development that took place in the Blair Laboratory had more impact on sector development than any external research findings or results.

5.3 Constraints to Rural Water Supply and Sanitation Development

A joint WHO/World Bank Sector Study which was undertaken in late 1981 soon after Independence identified three major constraints to the development of the water sector (Vogel, 1981). At this point it is worthwhile to

recount the findings of the study as they particularly relate to the operations of the government system:-

a) Insufficient Intersectoral and Interagency Coordination

It was felt that there was insufficient coordination among the different ministries with sector interests at the various operating levels. Although senior officials of the various ministries met periodically, such meetings were essentially on an ad hoc basis in order to discuss specific problems mainly related to administrative and financial matters. Moreover, there appeared to be insufficient coordination of planning criteria, which further emphasized the sector's fragmentation. While attempts were made to establish a National Action Committee for water supply and sanitation, such efforts were not effective. The particular need to increase coordination between the MEWRD, DDF and MOH was stressed.

b) Insufficient Community Participation

It was also felt that in the past, efforts had not been made to stimulate community involvement since there was little interest in motivating the rural majority to participate in the country's development efforts. Moreover, such motivation would have made the rural population even more aware of their underprivileged status and raised expectations which the previous Government was not prepared to satisfy.

Although immediately after Independence, local authorities in communal lands (District Councils) were formed, at the time of the study they were still in a transitional period with limited administrative and financial capacity. They had not yet reached the necessary stage to provide the administrative structure to promote a more active community involvement.

The Sector Study also indicated that there appeared to be insufficient consideration of community participation in the planning, construction as well as operation and maintenance of water facilities. This was particularly

apparent in the programme of piped rural water supplies, in which there was no element of local participation either in the construction or in operation and maintenance. Moreover, there was no charge for the water consumed. It was felt that insufficient involvement in the project cycle of the intended beneficiaries would lead to a general attitude being adopted - that it was up to the Government to provide water for all their needs and free of charge - and hence the water programmes may be deprived of the benefits which could be obtained through community participation. As a consequence, possible savings in the construction and operation of the facilities would not be obtained. Moreover, the insufficient application of low cost and appropriate technology would further increase costs. Considering the limited Government resources available, the high programme costs would therefore mean that only a limited number of people would benefit, and the goal of total coverage, and the aspirations of privilege would not be achieved in the near future.

c) Insufficient Health Education

It also appeared to the WHO/World Bank team that the significance of drinking water quality and adequate sanitation relative to health was not perceived to a significant extent by the rural population in the communal areas. The traditional (and usually contaminated) well sufficed to satisfy water needs much of the time and when it ran dry, a trip to a more distant source was the traditional solution. It also seemed that the desire for knowledge as to how such improvements might be obtained by using the latent resources of communities was limited. It was also apparent that only in isolated cases was it clear that the rural population perceived the need for developing and maintaining safe and adequate excreta disposal facilities. Therefore, the insufficient emphasis made in the past on health education and on the motivation of the community toward action based on knowledge, constituted a major constraint to sector development in the rural areas.

The WHO/World Bank Sector Study raised a number of significant issues without providing any solutions, while other issues were omitted. For example, while the particularly low service coverage levels and the need for capital investment and community participation was highlighted, a strategy for improving the situation was not recommended. Government's failure to recover the costs of the provision of water was also highlighted. However, the ability and willingness to pay of the rural population was not discussed. Also, the lack of coordination between Government Ministries was discussed at length. However, the issues related to the interaction between Government and the donor community was ignored. This is a classic example of the limited and biased perspective assumed by an external donor in the analysis of a country situation from within his own sphere of interest (Chambers, 1983). At this point it may be worthwhile to review in more depth some of the issues raised or omitted in the WHO/World Bank Sector Study.

5.4 Ability & Willingness to Pay for Water & Sanitation in Communal Areas

Ability and willingness to pay surveys are notoriously difficult and inaccurate. However, they can provide a general indication that rural communities do perceive water and sanitation as real priorities as expressed in a willingness to contribute or pay a substantial proportion of their income or surplus. Furthermore, some studies attempt to test that if income or surplus could be increased, would there be a corresponding willingness to pay for other or higher levels of service?

During the preparation of the NMPRWSS a willingness to pay study for water and sanitation in communal areas was undertaken in order to gauge the rural communities ability and potential to contribute to water and sanitation improvement (MEWRD, 1985). It was found that the mean

monthly income was approximately Z\$55 per month, see table 8, and that rural residents would be prepared to pay 50 cents each month (median response) for a properly functioning standpost within 200 to 300 metres of their home. That is, if Government provided piped rural water supplies, half the population would be willing to pay 50 cents/house/month, see table 9. The survey also tried to determine how much rural residents would be prepared to pay for a good standard of pit latrine. The median response was Z\$50. That is, if the cost of building a latrine were Z\$50, approximately 50% of those surveyed would bear the cost and build a latrine, see table 10. At face value this study confirms the opinion expressed in the WHO/World Bank sector study that Government does not need to fully subsidize the provision of rural water supply and sanitation as there is an apparent demand and willingness to pay.

5.5 Overlapping Institutional Responsibility.

Several institutions are responsible for the provision of rural water supply and sanitation in Zimbabwe, as part of the government system, these include:-

- a) The Ministry of Health;
- b) the Ministry of Energy and Water Resources and Development;
- c) the Ministry of Works;
- d) the Ministry of Local Government, Rural and Urban Development;
- e) the District Development Fund;
- f) the Ministry of Agriculture, Lands and Rural Settlements (an amalgamation in 1985 of the Ministries of Agriculture, Land Resettlement and Rural Development)
- g) the Ministry of Community Development and Women's Affairs;
- h) the Ministry of Finance, Economic Planning and Development.

Table 8.

Comparison of Rural Income Level Data Derived from National and In-depth Local Studies (from NMPRWSS, 1985).

Income group Z\$/month	In-depth socio- economic studies % population	National Survey % population
0-10	23.45	24.49
10-24	18.14	27.03
25-49	20.35	21.40
50-99	18.14	13.96
100+	19.91	13.12

Table 9.

Ability to Pay for Water in Rural Areas (from NMPRWSS, 1985)

Income group Z\$/month	Ability to pay Z\$/month	Proposed max. charge as % of income	% Population with ability to pay
0-10	2.5	0.12	24
10-24	3.0	0.50	18
25-49	3.5	1.30	20
50-99	4.0	3.00	18
100+	5.0	5.00	20

Table 10.

Willingness to Pay for Improved Pit Latrines in Rural Areas - cut-off point response (from NMPRWSS, 1985).

Willingness to pay Z\$	Number of Responses	% of responses	Cumulation %
0-10	27	12.8	12.8
11-25	43	20.4	33.2
26-50	45	21.3	54.5
51-75	19	9.0	63.5
76-100	23	10.9	74.4
101-150	13	6.1	80.5
151-200	9	4.3	84.8
200+	32	15.2	100.0

a) Ministry of Health

Since Independence in 1980, the MOH has restructured itself in an effort to change from an urban curative institution to a rural preventative service. Emphasis is placed on developing a rural health infrastructure and introducing primary health care in order to redress the pre-Independence imbalance in which most health services were concentrated in urban areas serving a minority of the population. Provision of water and sanitation is seen to be an integral part of the rural health package together with EPI and MCH et cetera.

Within the MOH, the divisions of interest are the Public Health Inspectorate which is involved in the improvement and protection of shallow wells and the construction of latrines, and the Village Health Worker programme, both of which support a large cadre of extension staff. The Health Inspectorate is staffed by some 40 Health Inspectors and 350 Health Assistants based at provincial district and ward level. The ward level Health Assistants support and supervise some 4000 Village Health Workers. As an integral part of the local community, the Village Health Worker is in a good position to identify concerns, felt needs, causes of ill health and actual diseases. He/she makes appropriate referrals and expends major efforts in health education and mobilizing communities into taking preventative measures such as latrine building and water protection.

At the ward level rural health centre (the basic unit of the rural infrastructure), one medical assistant handles medical services for those referred by the Village Health Workers, one medical assistant works with the maternity and child health programme and one Health Assistant focuses on appropriate environmental interventions, supporting the efforts of the VHW.

The Ministry's structure provides for administration at national, provincial and district levels and representation at ward and village levels.

b) Ministry of Energy Water Resource and Development
(MEWRD)

The MEWRD is responsible for the following activities; the planning of river catchments, the provision of major dams for irrigation, the supply of water to Government installations, the supply of "piped" water to large rural villages, the drilling of boreholes in rural areas and the supply of bulk raw water to urban areas.

The Ministry's structure has remained virtually unchanged since before Independence. However, more emphasis has been placed on the drilling of boreholes in rural areas in response to both Government's policy of rural development and the need for emergency drought relief. The Ministry's structure consists of a national headquarters and five provincial offices. MEWRD is not represented at district level and below.

c) Ministry of Works

This Ministry, among others, is responsible for the preparation of plans and the construction of Government buildings. It is also responsible for water distribution within Government installations and controls sewerage including sewage treatment facilities for most of such installations.

d) Ministry of Local Government Rural & Urban Development
(MLGRUD)

The MLGRUD is generally responsible for establishing and supporting Government's local administration structure and the planning of urban and rural development, through a senior staff of eight provincial and fifty-five district administrators who chair Provincial and District Committees. In parallel, local development planning and coordination is overseen by eight Provincial Governors' responsible to the Prime Minister through a Minister of State. They are charged with involving local communities in planning, and improving cooperation between the communities

and the governmental structure in order to achieve a more efficient use of Ministerial and local inputs in the accomplishment of objectives.

One of the major post-Independence rural development initiatives undertaken by MLGRUD is the establishment of centres of service and opportunity for economic activity in the communal and resettlement areas.

e) District Development Fund (DDF)

Pre-Independence, a fund, known as the "African Production and Marketing Development Fund", was established by Act of Parliament in the then Ministry of Local Government and Town Planning for the purpose of developing the Tribal Trust Lands. Since Independence, the fund, a semi-autonomous parastatal, has been renamed the District Development Fund which is responsible for the reconstruction and primary development of roads, water supplies, buildings and training establishments as well as normal maintenance of infrastructure in the communal lands. The Fund operates depots and workshops at all provincial and district headquarters, and also provides lesser facilities for service and minor equipment repairs at some sub-stations based at ward level.

DDF also provide training facilities in aspects of two fields, namely building/construction and vehicle/maintenance. The latter includes training for men who could carry out repairs to borehole pumps, piping and surface pumps for supplies for domestic, stock and dipping services.

Major revenue sources are foreign aid and Government grants which after Independence were immediately directed to the repair and reconstruction of boreholes and other infrastructure in the rural areas damaged during the liberation war. This reconstruction effort was merged into a drought relief effort especially during 1983 and 1984.

f) Ministry of Agriculture, Lands and Rural Settlements

The Resettlements Division of this Ministry was newly

formed after Independence and is mainly concerned with Government's programme aimed at the acquisition of commercial farming land for the resettlement of returning refugees, displaced persons as well as spill over from the overcrowded communal lands. The provision of infrastructure and services, including water supplies, sanitation and social welfare within these areas (in conceptual framework of integrated rural development), is the responsibility of Divisional resettlement officers based at provincial and project level. The programme attracts massive donor support especially from the British Overseas Development Administration (ODA) as a result of the Lancaster House Agreement.

Similarly, funds for water and sanitation are channeled from the Lands Division, through the Agricultural and Rural Development Authority (ARDA), a Government parastatal under MALRS, who have adopted an "Intensive Rural Development Areas" approach. The MALRS assumes an important role in the development of water supplies and sanitation in the communal areas as part of both Resettlements and Intensive Rural Development Programmes.

g) Ministry of Community Development and Women's Affairs
(MCDWA)

Formed after Independence, the MCDWA although not involved in physical implementation of water and sanitation is theoretically involved in "communications support" activities such as community mobilization et cetera.

MCDWA's role, amongst other things is the articulation of communities' felt needs for water and sanitation and to support and stimulate the communities own efforts to develop these facilities. The MCDWA is also charged with coordinating all village level development activities. In 1984, a Prime Minister's Directive instructed that all community development workers should be supervised by MCDWA including the MOH's VHWS. These grass roots activities are undertaken by a cadre of some 250 extension workers whose title Home Economic Demonstrators belies their function

(NAC, 1983). However, the most important role of MCDWA, in terms of its coordination and leadership role at community level, is in the formation of village development committees (VIDCOs), and the promotion of VIDCO operations in the development process. Both of these committees have an important role in the planning and operations and maintenance of water supplies (Samset & Lenneiye, 1987).

h) Ministry of Finance, Economic Planning and Development (MFEPD)

The MFEPD which was carried over from pre Independence remained the senior most Government institution and the focal point for the formulating of national development plans. It establishes and administers domestic budgets and is the nodal body for negotiating and coordinating donor support to the various development sectors with advice and support from the line ministries. Theoretically its concerns are macro economic and financial and as such one of its main tasks is to establish priorities within the various sectors. However, the majority of its resources and efforts are devoted to the administration and book keeping functions of Government.

5.6 Donor Support to the Sector

A number of multilateral and bilateral donors, and NGO's actively supported rural water supply and sanitation sector development, both directly and indirectly (Boydell, Belrring & Madsen, 1985). These donors are listed in table 11. The sectoral development priorities supported by the donors are theoretically determined through negotiation with the MFEPD. However, most donors had a mixed portfolio of aid projects within their "country frame" determined by domestic policies and other predispositions.

Of the multilaterals; UNICEF supported a well sinking programme as an extension of their health philosophy; the EEC supported the MOH's pilot rural water supply and

Table 11.

List of Development Agencies Supporting the Rural Water Supply and Sanitation Sector in Zimbabwe
(from Boydell et al, 1985).

Agency	Common Acronym	Category	Technical Assistance	Training	Project Funding	Project Implementation
Australian Development Assistance Bureau	ADAB	Bilateral	X	-	X	-
African Development Bank	AfDB	Regional Multilateral	-	-	X	-
Canadian International Development Agency	CIDA	Bilateral	-	-	X	-
Christian Care	-	N American NGO	-	-	X	-
Commission on Social Services Development	CSSD	Zimbabwean NGO	-	X	X	X
Danish International Development Agency	DANIDA	Danish Bilateral	X	X	X	-
Deutsche Gesellschaft fuer Technische Zusammenarbeit	GTZ	W German Bilateral	X	X	X	X
Directorate General Internationale Samenwerking	DGIS	Dutch Bilateral	-	-	X	-
Dominican Sisters	-	Zimbabwean NGO	-	X	X	X
European Economic Community	EEC	Multilateral	-	-	X	-
Freedom From Hunger	-	European NGO	-	-	X	-
Italian Dept of Cooperation	IDC	Bilateral	X	-	X	-
Japanese Agency for Inter-nat'l Coop. & Assistance	JAICA	Bilateral	-	-	X	X
Lutheran World Federation	LWF	European NGO	-	X	X	X
Norwegian Agency for International Development	NORAD	Bilateral	X	X	X	X
Overseas Development Administration	ODA	British Bilateral	X	X	X	X
Organization of Rural Associations for Progress	ORAP	Regional NGO	-	X	X	X
Oxfam (UK)	-	British NGO	-	X	X	X
Redd Barna	-	Norwegian NGO	-	X	X	X

Table 11 Continued:

List of Development Agencies Supporting the Rural Water Supply and Sanitation Sector in Zimbabwe.

Agency	Common Acronym	Category	Technical Assistance	Training	Project Funding	Project Implementation
Save the Children Fund	SCF	British NGO	-	X	X	X
Swedish International Development Agency	SIDA	Bilateral	-	-	X	-
St Paul's Mission	-	Zimbabwean NGO	-	X	X	X
United Nations Development Programme	UNDP	Multilateral	X	-	X	-
United Nations Childrens Fund	UNICEF	Multilateral	X	X	X	X
United States Agency for International Development	USAID	Bilateral	-	-	X	-
War on Want	-	British NGO	-	-	X	-
World Health Organization	WHO	Multilateral	X	X	-	-

sanitation projects through their Micro Projects Fund. UNDP/World Bank, through the TAG Project provided some technical assistance to the MOH and to the water sector in general (UNICEF, 1984/87. EEC, 1984/87).

Of the bilateral donors; ODA and JAICA were among the first to enter the arena after Independence by providing support through MEWRD to the resettlements programme, and a borehole drilling programme, respectively. ODA were fulfilling the spirit of the Lancaster House agreement, whereas JAICA were apparently looking for markets for their drilling equipment and contractors. GTZ provided indirect support to the MOH's rural water and sanitation activities through the integrated rural development project in Masvingo Province (MEWRD, 1984/87).

Whereas, SIDA and DANIDA entered the sector a little later, SIDA through an extension of their support to the MOH's primary health care programme and DANIDA as direct rural water project support through MOH and UNICEF. NORAD, who from immediately after Independence had supported the rural Reconstruction Programme through the DDF, later changed counterparts to the MEWRD for the funding of a National Master Plan for Rural Water Supply and Sanitation. NORAD changed partners again, and later coordinated their resulting programme of implementation through the MLGRUD. This is discussed in chapter 6. Apparently the Nordic donors supported the water sector as an extension of their socialist philosophies; the sector also apparently provided a means of disbursing their overly generous aid budgets (NORAD, 1984/87. DANIDA, 1984/87).

Of the international NGO's; the Lutheran World Federation, War on Want and Freedom from Hunger became active in the sector immediately after Independence through direct project support and implementation as an extension of their relief efforts during the liberation struggle. Save the Children Fund, through its support of the MOH's primary health care programme also provided indirect support. Two NGOs carried significant sector support over from pre-Independence as a extension of their religion

based missions; the Commission on Social Services Development and St. Theresa's Mission (CSSD, 1984/87). Most of the programmes mentioned above are described in some detail in the case studies that follow.

As can be seen from table 11 all 27 donors supporting the sector provided project funding. Whereas, only half provided training, and less than a quarter provided a mixture of technical assistance, training and project implementation.

5.7 Interministerial Coordination and the International Drinking Water Supply and Sanitation Decade in Zimbabwe

The IDWSSD was formally launched at a special session of the UN General Assembly on the 10th November, 1980. At that time, Zimbabwe was preoccupied with the demands of its newly acquired independent status and it was not until two years later that the IDWSSD was acknowledged. On the 10th November, 1982, the Honourable Prime Minister Robert Mugabe formally launched the Water Decade in Zimbabwe by the signing of a certificate of official support that was given worldwide publicity. At the launching, an IDWSSD National Action Committee (NAC) was brought into being which represented the government system. This included members from 14 Ministries and bodies involved in the water and sanitation sector, namely; MOH, MEWRD, MOW, MLGRUD, MALRS and MCDWA. The NAC was chaired by the MOH and the secretary was drawn from MEWRD. No donors other than NORAD were involved. Three NAC sub-committees were formed at the same time. Base Line Data Collection chaired by MEWRD. Community Participation chaired by Ministry of Community Development and Women's Affairs and Public Health Education chaired by Ministry of Education. Subsequently in April 1984, a fourth sub committee was established, namely, the Steering Committee for the NMPRWSS. Also in 1984, a working party or group was formed in the Community Participation Committee to make recommendations for hand pump standardization and a pump maintenance structure.

The last meeting of the original NAC chaired by MOH was in October 1984. It lasted in reality for less than two years. The NAC had failed to stimulate the interest of senior government officials in coordination and collaboration. Meetings were attended by juniors from the various ministries involved who had neither power nor commitment. The revised NAC under the new chairmanship of MLGRUD first met in April 1986. Of the sub-committees, the Base Line Data Collection Group was abandoned as much of its function was taken over by the master-planning team who undertook a national socio economic survey and inventory as part of the planning process (MEWRD, 1985). The Public Health Education Committee produced a number of good booklets and articles which were distributed throughout secondary schools but the committee lost impetus and fell dormant. Similarly, the Community Participation Committee and its working group on handpumps also lost its momentum after promoting some useful activity such as an Interministerial Workshop on Community Participation in Wells Construction (Dunets, 1985), which produced recommendations for involving people in point water supply development. The most intensely active of the sub-committees was the NMPRWSS Steering Committee that was driven along by the NORAD Masterplan coordinator in MEWRD. The NAC which had become weak through Government indifference was captured by the donor NORAD in order to pursue its own programme interests. Its new functions are described in more detail in the following chapter.

5.8 Summary

The rural water supply and sanitation ~~supra~~ system and its environment in Zimbabwe, some six years after Independence, can be characterized by the levels and demand for services, Government's policies and developmental interventions, and the three dominant systems; the external donors supporting the sector, the Government institution and the community. These may be summarized as follows:-

The Government system comprises of a number of institutions with overlapping responsibilities and functions. Of these Government bodies there are three main actors in the sector the MEWRD, MLGRUD's DDF and the MOH, each of which are legacies of the colonial state. However, the MOH has restructured itself in order to deliver a primary health care programme, and be more effective at community level, and has tried to refine a rural water supply and sanitation delivery strategy in three pilot projects. DDF is also following suite, having been involved in the reconstruction programme is now trying to address the issues of maintaining rural water supplies, both have a district level structures. Whereas, the MEWRD which was structured pre Independence to support urban water supplies and commercial farm irrigation schemes, does not have a district level structure, and remains ill equipped to deal with dispersed rural communities and a participatory approach to development. However, MEWRD continue to argue for major role in sector development particularly in borehole drilling.

Zimbabwe has a well developed appropriate water supply and sanitation technologies which are a product of local research efforts. These are a locally designed and produced latrine and hand pump that have been widely adopted by the Government agencies. Although appropriate technologies are available, an effective complimentary delivery mechanism and community involvement strategy are lacking.

Coverage levels of both water and sanitation services in communal areas are low, but a high demand for water exists, however, there is a lesser demand for sanitation. The rural population are believed to have an ability and willingness to pay for or contribute to water services. However, the sector development constraints that were identified in the IBRD/WHO sector study just after Independence, that is, lack of interministerial coordination and lack of community involvement and health education, still remain.

Zimbabwe is also strongly committed to the aims and

goals of the Water Decade, but in the process of developing a series of centrally designed vertical projects that are not fully integrated into the overall rural development programme. An IDWSSD National Action Committee had been formed together with sub committees who would address the issues identified as constraining sector development in the World Bank Sector Study carried out after Independence, that is, lack of interministerial coordination, lack of community participation and lack of health education (Vogel et al, 1981), However, the NAC became weak and was captured by NORAD the donors programme.

The donor system comprises a multiplicity of agencies supporting the sector, ranging from small NGOs working at grass roots level, to bilateral donors with large development budgets who provide support to national programmes through providing technical assistance to central Government's line ministries and the provision of capital grants. The donor's priorities in supporting particular developmental sectors is largely driven by their own predispositions. With regards to the community system which was discussed in chapter 4, there is a tendency by both Government and donors to assume that it is homogeneous group of people waiting to respond to what ever programmes are developed. This assumption is explored in the case studies that follow.

This summary would not be complete without mention of two externalities which constrained post Independence water sector development; the drought that occurred between 1982 and 1985, and the armed conflict that raged between the two opposing tribally based political parties - ZANU and ZAPU. However, despite all this significant improvements were made, for example, over 100,000 Blair latrines were constructed in the rural areas. At this point in order to complete the sector overview we should review the development of the National Master Plan for Rural Water Supply and Sanitation, which was the most significant donor intervention in the water sector after Independence.

- o 0 o -

Chapter 6

The National Master Plan
for
Rural Water Supply and Sanitation
and
NORAD's Long Term Programme

- o 0 o -

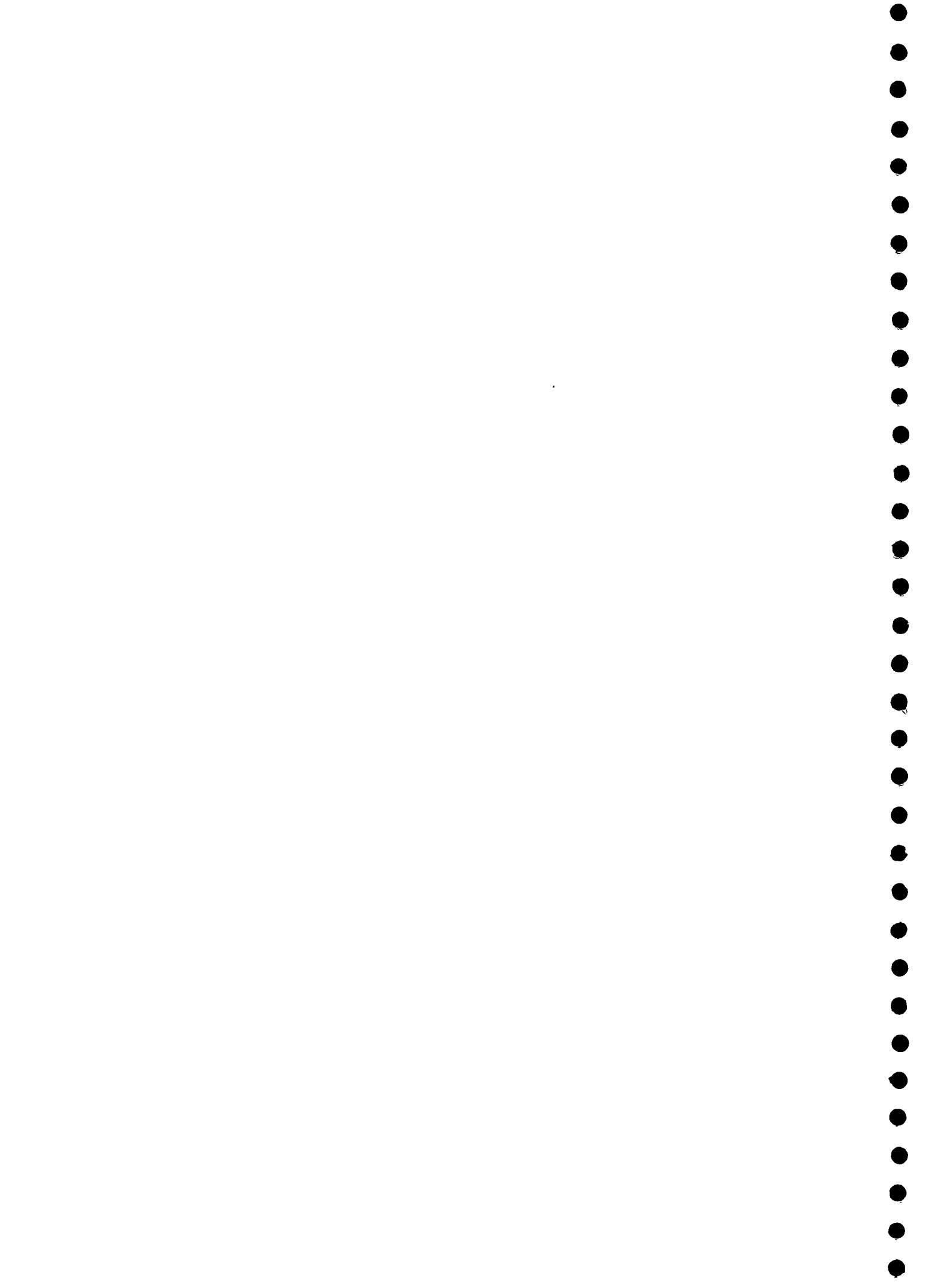

Chapter 6

The National Master Plan for Rural Water Supply and Sanitation and NORAD's Long term Programme

In order to complete the picture of the rural water supply and sanitation supra system in Zimbabwe, this chapter describes the events leading up to, and the preparation of the National Master Plan for Rural Water Supply and Sanitation, which was funded by the Norwegian bilateral aid agency NORAD, and undertaken by a Norwegian consulting engineering company. This activity was the most significant post Independence donor intervention and deserves special review. The chapter then goes on to describe the subsequent development of the NORAD aid programme within the sector.

6.1 The National Master Plan for Rural Water Supply and Sanitation

The concept of a National Master Plan for Rural Water Supply and Sanitation (NMPRWSS) for Zimbabwe was first discussed between the Swedish bilateral aid agency SIDA, and the Ministry of Energy and Water Resources Development (MEWRD) in 1982. This led to a terms of reference (TOR) being prepared by a visiting team of Swedish consultants who collaborated with MEWRD, but who significantly did not discuss their proposals in depth with other institutions such as the Ministries of Health, Local Government and Economic Planning. The terms of reference directed the planning team to review the sector and provide recommendations as to medium and long term sector development proposals for villages, rural service centres and growth points in communal lands and resettlement areas. The TOR specifically directed the consultant to study the following topics (MEWRD, 1983):-

- Planning Strategy

- Water Demand
- Water Resources
- Technical Options
- Village Participation
- Sanitation
- Organization
- Manpower and Training
- Financial and Economic Plans
- A 10 Year Development Plan
- A 20 Year Development Plan

In parallel, discussions regarding potential support were taking place between MEWRD, and the Norwegian Bilateral aid agency NORAD, who at that time were funding other water sector rehabilitation activities in Zimbabwe through the DDF reconstruction programme. It was apparently decided in discussions between the two donors, that NORAD should adopt the SIDA/MEWRD terms of reference, and provide funds for a Norwegian Consultant Engineering Company to prepare the master plan, as NORAD were planning to devote a majority of their future aid programme resources to water sector development. SIDA continued to concentrate its support to the health sector.

During 1983, proposals were solicited from Norwegian consultants, and by October Interconsult (a new company formed by a consortium of Norwegian domestic consultants to undertake overseas assignments) had established an office in Harare. The stage was set with a series of tensions.

1 MEWRD were looking for a plan to justify a lead agency role
 2 for themselves in the sector. NORAD were seeking a plan to
 justify their continued and expanded investment in the
 sector, and although their existing counterpart agreement
 was with DDF, through whom they had already made
 substantial investments they had opened a dialogue with
 3 MEWRD, and Interconsult were seeking to maximize their
 first major assignment.

At the same time NORAD recruited an expert, the masterplan Coordinator who was assigned to MEWRD to assist them in supervising the consultant. Government formed an

interministerial masterplan steering committee, that was established as the forth IDWSSD National Action Committee, sub committee, with representation from the Ministries of Health, Water, Agriculture, Finance, Local Government, Labour and the Central Statistics Office, DDF, NORAD, and Interconsult.

Interconsult employed some sixteen professional staff who by August 1985, (some six months late), produced an 18 volume draft master plan which was handed to Government for comment. In response Government restructured the Steering Committee as a Review Panel. The panel during a series of meetings with Interconsult compiled a list of fundamental revisions to the plan. The original terms of reference allowed a three month period for revisions, however, the revisions took more than a year to complete, and at the time of writing, the plan is still not accepted by Government. The main criticisms of the plan as identified by the review panel were:-

a) The volumes on Management, Operations and Maintenance, Human Resources Development (HRD) and the Design Manual were unsatisfactory and required further research and major redrafting. The HRD manual failed to address the issue of retraining conventional engineers and other technicians in a new "socially aware" role that encompassed involving the community in their planning process, also it did not address the community level training issues. The Design Manual was a regurgitation of all other standard design manuals which failed to address the specific issues of Zimbabwe or focus on the needs for appropriate technology. Similarly, the Management and Operations and Maintenance Manuals failed to address the community level issues and needs.

b) The level and value of potential community participation in sector development had not been adequately researched and detailed. The plan envisaged a large centrally managed programme executed by the MEWRD and DDF with major external support.

c) The alternative costs of varying levels of service and their economic implications had not been adequately explored. The plan advocated major investments in piped water supply schemes where other cheaper and more appropriate alternatives were possible.

d) The high levels of service for very small communities was impractical.

e) The costs of operations and maintenance and potential for cost recovery had also not been explored.

f) The relative priorities of new water supplies, as opposed to rehabilitation and upgrading, had not been considered (Dunets, 1985).

6.2 The NORAD Long Term Programme

At the time the NMPRWSS was being revised NORAD appointed another consultant, HIFAB, to undertake a study on management and coordination within the sector as a basis from which to plan the disbursement of some Z\$20 million that had been allocated to the sector within their current aid programme. The report which was presented to Government in March 1984 made the following recommendations as to the programmes long term objectives (Haugland, 1984):-

a) The long term objective of the programme should be the improvement of living conditions and welfare of the rural population through improved health and rural economy, and the reduction of the burden on women and children.

b) The programme should be confined to a limited geographic area and implemented within the guidelines embedded in the master plan.

c) The programme should as far as possible complement other development efforts, recognizing that economic development is the prerequisite for improved health, along with the provision of safe drinking water. The provision of drinking water for productive purposes, therefore, should also have a part in the programme.

d) It is generally recognized that the improvements of health and welfare can best be achieved through integrated

development programmes in which sanitation and health education are promoted alongside the provision of new water supplies. These elements should be addressed in the programme.

e) Traditionally it is mainly women and children who carry water and wash clothes et cetera. These tasks are time consuming especially if the water is far away and scarce. Therefore, a water programme must address itself to the population groups most in need, that is, women and children.

The report recommended the following actions:-

- The programme should concentrate in the Mashonaland Provinces.
- Increasing amounts of funds should be spent on operations and maintenance during the early years of implementation.
- The amount of finance to be disbursed over a twenty year period.
- That human resources should be developed at various levels in the various sub sectors.
- Community participation to be encouraged to decrease costs of operations and maintenance.
- Women should be the main target group.
- Sector coordination should be undertaken by a revised IDWSSD National Action Committee.
- NORAD should appoint a coordinator in MLGRUD.
- That NORAD, SIDA and DANIDA should coordinate their programmes.

Although the HIFAB report compensated for some of the shortcomings of the NMPRWSS, its detailed recommendations fell short of its conceptual objectives. A centrally managed programme under the control of a NORAD coordinator in MLGRUD would not appear to be the optimum structure for community based integrated rural development, and Government were reluctant to accept the report until the master plan was complete. The detailed recommendations listed above did however, become the basis of the NORAD long term programme. In the mean while, NORAD, in response to the drought of that time funded the Crash Borehole

Drilling Programme as an extension to their agreement with DDF (see Chapter 14). This eased their disbursement problems.

The HIFAB report also made detailed recommendations on the somewhat dormant National Action Committee, it proposed that the NAC be reestablished, chaired by MLGRUD and should comprise of representatives of DDF, MEWRD, MOH, MCDWA, MFEPD and MALRS, with the NORAD National Coordinator as secretary. The NAC's new function were to coordinate the National Master Plan and effectively NORAD's own programme, none of the other numerous donor programmes were discussed during NAC meeting between 1985 and 1987. NORAD Had effectively captured an interministerial Government Committee to serve its own programme interests. The TOR of the new NAC were to:-

- a) To examine the programme/plans formulated by the national coordinator paying particular attention to modifications made by him to provincial plans to ascertain if the reasons for changing the province's own proposals are justified. The new planning procedures should not mean that MLGRUD and operational ministries must automatically accept the provincial and district development plans. If MLGRUD or operational ministries believe that certain elements of proposals should be excluded they will be discussed in the NAC.
- b) To modify, if necessary, and approve the national coordinator's proposed allocation of duties and funding. The National Action Committee will be a Steering Committee without any official decision making authority and its approved plans will not be binding on the Minister (MLGRUD), but MLGRUD having chaired the meetings will normally be expected to adopt the NAC programmes/plans.
- c) To make recommendations on policy matters for the rural water supply and sanitation sector.
- d) To keep all ministries and donors informed about progress in all areas of the sector.
- e) To advise MEWRD on its continuous collection and processing of data for the updating of the NMPRWSS.

- f) To coordinate training and education within the sector.
- g) To ensure monitoring and evaluation of the sector and its programmes.
- h) To promote the importance of an integrated approach to rural water supply, sanitation and health education within ministries.
- i) To appoint sub-committees for technical administrative procedures/solutions and arranging seminars and national meetings relating to the sector.

6.3 Summary

The draft NMPRWSS, the only sector policy guide that presently exists, has a number of deficits in its concepts and recommendations, which mirror some of the concerns regarding the global interpretation of the IDWSSD by the donor system as stated earlier. The terms of reference failed to direct the consultant toward viewing water and sanitation development as an integral part of Zimbabwe's overall rural development process; integration being a fundamental part of the development philosophy adopted by Government. This resulted in the plan recommending a top down planning structure and process for a single sector programme which conflicts with Governments drive toward decentralization and integrated rural development. Also, by addressing the national level sector management issues "head-on", the NMPRWSS has also provoked an unproductive and unresolved confrontation between MEWRD and DDF as to who should be responsible for borehole drilling. This was an overt symptom of the more basic issue; that the plans recommendations for major sector reform are politically and bureaucratically unacceptable to the government officials that are expected to implement them. Furthermore, the plan which is preoccupied with hydrogeological data and national level management issues et cetera, fails to emphasize the concepts of community involvement, appropriate technology, cost recovery,

strengthening of district level planning and extension services.

The proposals prepared by HIFAB for NORAD's longer term involvement in the water sector as the lead donor, made up for some of shortfalls of the NMPRWSS (Haugland, 1984). However, the revitalization of the NAC with external technical assistance, notionally as the sector controlling and coordinating body, but primarily dealing with the NORAD programme reinforced the vertical approach proposed in the NMPRWSS (Wall-Bake et al, 1987) and emphasizes the point that the Master Plan was prepared from the self interest perspective of the donor and his consultants. The systems relationships in the preparation of the NMPRWSS are shown in figure 9, and the systems analysis is summarized in table 12.

Figure 9. Systems Diagram for the Preparation of the National Master Plan for Rural Water Supply and Sanitation.

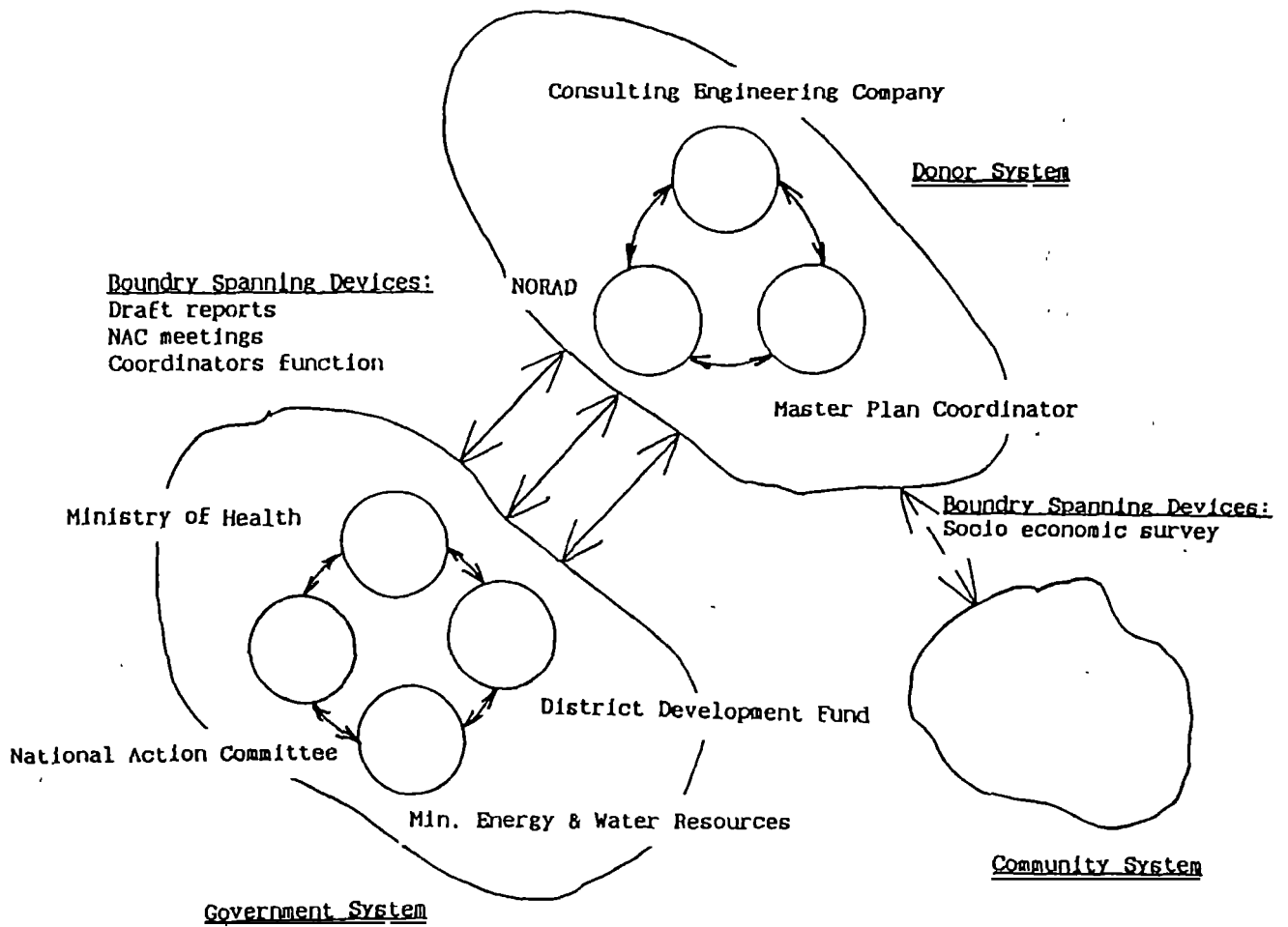

Handwritten notes:

Her kan ansvarshavende er:
[Handwritten diagram with circles and arrows]

[Handwritten notes and diagrams]

Table 12Summary of Systems Analysis for the Preparation of the National Master Plan for Rural Water Supply and Sanitation1. Systems Present and Their Function

A donor who funded and undertook the preparation of the plan; Government who had a limited function of steering and reviewing the planning process; and the community who peripherally involved as the beneficiaries who were surveyed.

2. Actors and Their Roles

Donor: The bilateral - NORAD who funded the project; the Norwegian Consulting Company who undertook the planning exercise; expatriate TA personnel in Government who represented the donors interests; short term consultants who were advisers to the donor.

Government: MEWRD, MLGRUD/DDF, MOH who were the counterpart central ministries with whom discussions took place; the NAC sub committee who reviewed the draft plan.

Community: Representative groups who were surveyed.

3. Leaders and Accountability

Donor: The expatriate advisor in MEWRD and the manager of the consultants who were accountable to the donor headquarters and superficially to Government.

Community: Not applicable.

Government: the chief water engineer who was accountable to his ministerial headquarters; and the NAC sub committee that had no real accountability.

4. Perceptions and Self Interest

Donor: That water scarcity was a major problem and that the donor could support the Government in its provision. That a plan would form a blue print for a future aid programme in which the budget could be disbursed quickly. That Government was incompetent and that a consultant and TA was needed. That NORAD should be the lead donor in the sector. Whereas the consultant wanted to maximize profit and ensure continuity.

Community: Not applicable.

Government: To maximize the aid from the donor. Individual ministries wanted to control the sector by securing large external funding.

5. Goals and Criteria of Achievement

Donor: The timely preparation of documents; summary approval from Government; budget expended; continued employment of the consultant.

Community: Not applicable.

Government: Finalization of a plan to trigger funding; the control of the donor and hence the sector; to be seen addressing the water issues of the country.

Table 12 Continued6. Problem Definition and Solution

Donor: by the consultants and short term advisors.

Community: not applicable.

Government: by professionals in the central Government institutions.

7. System Interaction and Boundary Spanning

The interaction between the donor and Government systems was superficial as the donor's consultants who were located in parallel to Government had the direct responsibility for preparation of the plan, donor and Government came together at review meetings. The expatriate coordinator placed in Government was perceived to be serving only the donors interests and failed to effectively span the systems. The interaction between both the donor and Government with the community system was negligible, other than a socio economic survey.

8. Commonality and Conflict

The commonality in the donor and government systems was an appreciation of a need for improved water supplies. However, conflict arose within the Government system as there was competition as to who should lead the sector and control the donors resource inputs. The consultants were also in conflict with some elements of Government who believed in a different developmental approach.

Hydro

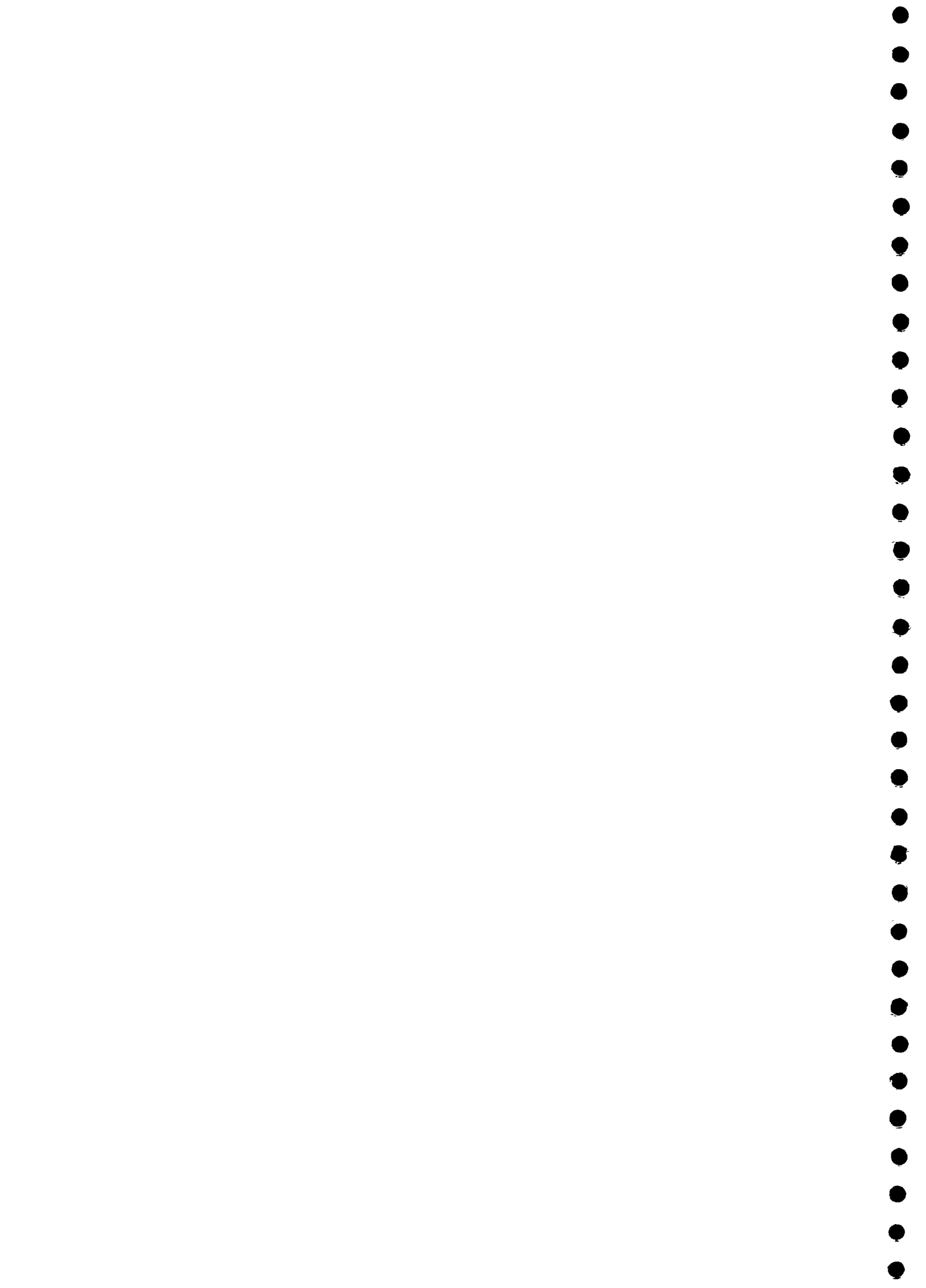

- o 0 o -

Chapter 7

Evaluation Methodology
for
Rural Water Supply and Sanitation Project
Case Studies

- o 0 o -

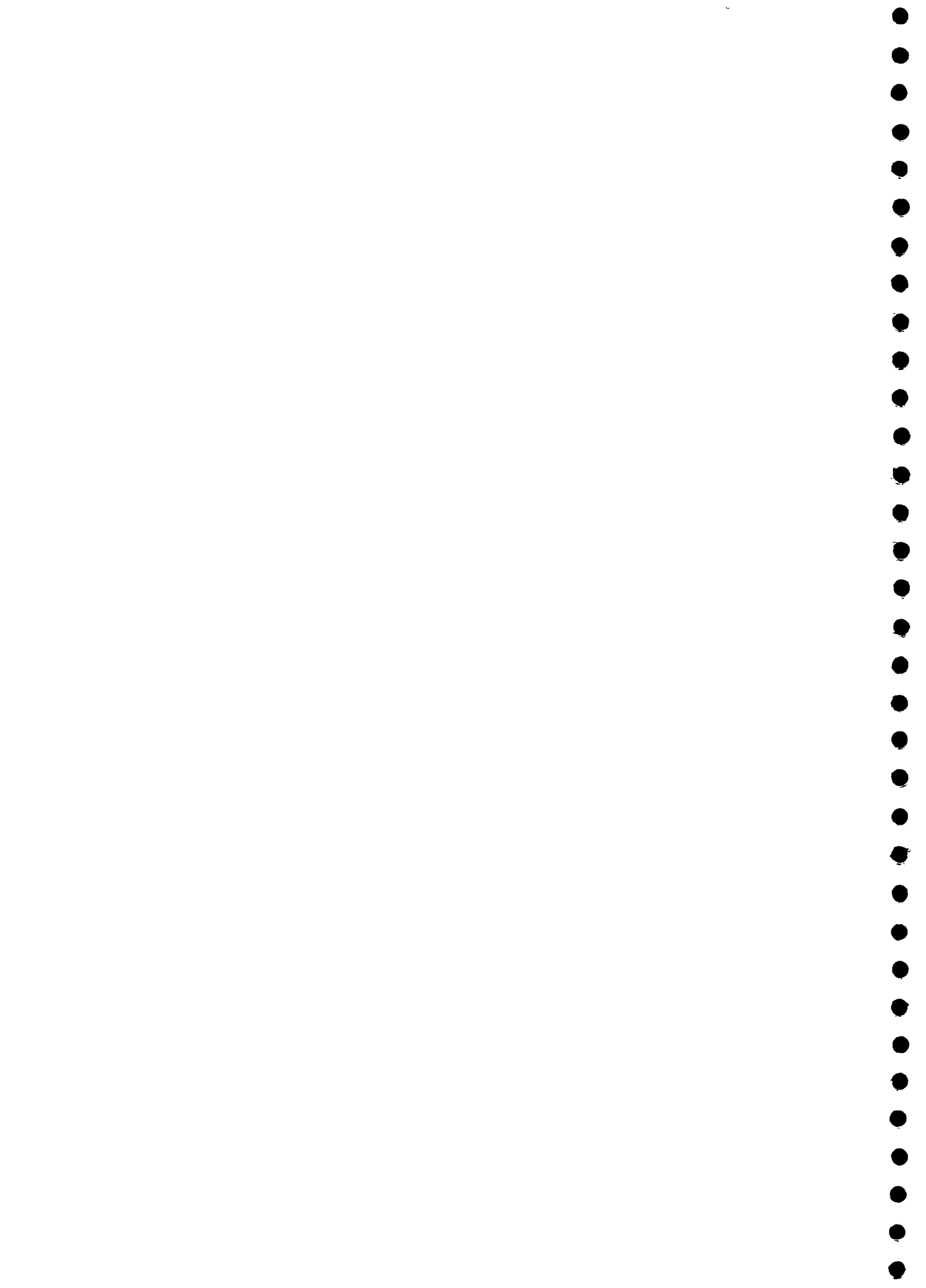

Chapter 7

Evaluation Methodology

for

Rural Water Supply and Sanitation Project Case Studies

In the previous chapters the broad environment of the rural water supply and sanitation supra system, and the government, donor and community systems in Zimbabwe has been described, and the approaches currently adopted in the design of projects and programmes has been reviewed. At this point the thesis turns to the analysis of a number of specific projects that have been undertaken by Government and donors that can be considered to be the outputs of these systems. This chapter lists the projects to be studied, and defines the purpose and limitations of evaluation. and then goes on to describe the methodologies used in the analysis of both the individual projects, and the sector development process to which they contributed.

7.1 The Projects Studied

The following chapters describe in some detail studies of the most important and significant rural water and sanitation projects that were undertaken in Zimbabwe between 1974 and 1986 a period which spans the gaining of Independence in 1980. The project descriptions which are listed below, are presented in a case study format, and in chronological order. This sequence will assist the reader in understanding the effects of one project on the next, and in tracing the development of the project implementation strategy and structure that was adopted by the post colonial Government and some donors. It also allows the different strategies and implementation models adopted by Government and the various donors to be compared and contrasted. The case studies also depict the increasing scope and scale of activities in the sector, and the

attempts to create linkages to other sectors, particularly health and agriculture. In addition chapter 15 provides abbreviated case studies of other projects that were also reviewed but in less depth. At the end of each case study a list of the valuable lessons to be learned is presented.

The case studies are:-

- a) In chapter 8 - St. Theresa's Mission Water and Sanitation Project in Chilimanzi.
- b) In chapter 9 - The Commission for Social Services Water and Sanitation Project in Mashonaland.
- c) In chapter 10 - The Ministry of Health Pilot Projects in Mhondoro, Serima and Zimutu (funded by the EEC and War on Want), and the subsequent MOH Expanded Programme (funded domestically with Freedom from Hunger and others).
- d) In chapter 11 - The GTZ funded Village Water Supply and Sanitation Programme in Masvingo Province, and the Coordinated Agricultural and Rural Development Programme in Gutu District.
- e) In chapter 12 - The UNICEF Assisted Wells Programme in Matabeleland Province.
- f) In chapter 13 - The Lutheran World Federation Wells Programme in Matabeleland
- g) In chapter 14 - The NORAD Crash Borehole Drilling and Long Term Programme in Mashonaland and Manicaland Province.
- h) In chapter 15 a review of: The DANIDA funded Rural Water Supply and Sanitation Projects in Midlands and Matabeleland North Provinces: The SIDA funded Primary Health Care Project in Manicaland Province: The Save the Children Fund Primary Health Care Project in Binga District, Manicaland North Province.

7.2 Evaluation

The main purpose evaluating these projects is to test the hypothesis, and the model for rural water supply

and sanitation project design and sector development presented in chapters two and three. The testing of these models requires that a number of specific questions be posed and answered (the questions and methodologies for asking them are discussed below). However, at this point, we should define and examine the limitations of evaluation. WHO (p3, 1983a), has defined evaluation as:-

"A systematic way of learning from experience, and of using the lessons learned both to improve the planning of future projects and also to take corrective action to improve the functioning, utilization and impact of existing projects. Evaluation does not in itself improve anything. It should not be just a listing of problems, and their possible causes, but should also include recommendations on actions needed to improve operations, functioning and utilization of facilities, complementary activities needed to be initiated or reemphasized to produce or increase benefits, modifications needed for future projects, and actions needed to ensure that the lessons learned are conveyed to other programmes or agencies."

This definition is adequate to describe a process that analyses an individual project and its internal components in order to provide useful information which can be utilized in designing a second similar project. Indeed, a number of techniques or tools are available for this analysis, some of which are described below. However, the above definition of evaluation falls short of adequately describing the analysis of the temporal process of development, where a series or sequence of projects may impact on the development of the sector by creating or heightening awareness, influencing Government policy, and attracting increasing amounts of donor investment et cetera.

7.3 Evaluation of the Temporal Aspects of Development

Eckaus (p1, 1984) states that:-

"Although change and growth have been dealt with extensively in the development literature, it is most often in a manner that avoids explicit consideration of time sequences, lags and delays. While avoidance may in part be due to analytical difficulties, it seems that the main obstacle is the lack of organized and explicit empirical information.....everyone knows, that for a lot of reasons, it takes a long time to develop, but no one knows much about the time sequence".

Tangible parameters for recording sector development are difficult to define and measure, particularly at the beginning of the process when the main developments are changes in awareness, policies and approach. However, later in the process, when wider scale implementation gets underway, criteria such as increasing levels of investment in the sector, and the rate of increase in the provision of services can be used (Freeman et al, 1979). In the following case studies a commentary on the changes in policy and approach that took place as a result of a sequence of projects and events is presented, together with a review of the increasing levels of service in the project areas. However, in the longer term, sector development analysis criteria, must be based on the concept of "sustainability of services".

7.4 A Case Study Approach in the Presentation of Project and Programme Evaluations.

Goodman and Love in their treatise on the management of development projects (1979), advocate a case study approach to the analysis of projects. They define a case study as a record of events and issues interwoven with facts and data that provides a useful tool in the understanding of four basic management issues. What is the

management function in planning and implementation? How well and effectively is this performed? What are the factors that contribute to or inhibit the development process, and how can project management be improved? Goodman and Love provide an extensive and exhaustive check list of questions to ask when evaluating a development project, this list is presented in Annex 4. However, as the systems model developed in chapter 3 will be used to evaluate the case studies and in addition to the management issues referred to above, there are a number of additional question that need to be posed, these are:-

Within the supra system

- What systems exist and how are they structured?
- How do the systems interact, are their boundaries permeable and have boundary spanning devices been established?
- Are there areas of commonality and conflict in the various systems? What is their environment?

Generally, within each system

- What is the output and who sets the goals and the criteria for evaluation?
- Who are the key groups/actors and what are their roles?
- Who leads, and what are the key concepts, traditions, and self interests of these groups?
- How are problems defined and solved - what are the procedures and consequences of this?

More specifically, within the community system

- What was the role of women?
- Was productive capacity improved together with the provision of basic services?
- Were O&M structures and capacity established?
- Was the ability and willingness of the community to pay for the service assessed and were any costs recovered?

Within the government system

- What was the role of the private sector?
- What was the role of extension workers?

Within the donor system

- What was the role of technical assistance and NGOs?

Within the projects

- Were the objectives clearly defined and were sufficient resources allocated to achieve these objectives?
- Were links established with other sectors?
- Was the project monitored and evaluated?
- Were distinct phases in the project development seen?
- What was the effect of this project on subsequent ones?
- Was appropriate technology utilized?
- Was health and hygiene education provided?

These are the criteria which the literative and theoretical analysis have identified. The suitability of this framework will be explored for each case study and modifications listed after each analysis.

Goodman and Love recommend that case studies should be presented sequentially, in four stages, to reflect the phasing in the development of projects. Phase 1, planning, appraisal and design. Phase 2, selection, approval and activation. Phase 3, operations, control and hand-over, and phase 4, evaluation and refinement. The format for the presentation of case studies in this thesis is a modification of this. However, in presenting the record of each project, greater emphasis is given to its historical development; the role of the donor, particularly the functions of NGOs and technical assistance; the role of the community and Government; intersectoral links, and the roll-on effects.

7.5 Project Evaluation Methodologies

A range of techniques were utilized in the gathering

and evaluation of data from the individual projects in order to construct the case studies. The evaluation approach or mix of techniques differed for each project depending on its size, complexity and status. Generally, quantitative data was derived from questionnaires and systematic inspections, whereas, qualitative data was derived from principal informant interviews and micro case studies (Yin, 1984). Table 13 indicates the range of techniques used for each project or programme. These techniques and methodologies are described below:-

a) Documentation Review

Project documents, as available, were reviewed in detail, particularly the original proposals and designs, together with progress reports, interim evaluations and terminal reports in order to assess if the originally proposed inputs had in fact been provided and if the anticipated outputs and targets had been achieved. The Logical Framework approach (PCI, 1969), was used to assist in this analysis; this is further described in section 7.7 below, and in Annex 3.

b) Principal informant Interviews

In depth interviews were held with key people related to the projects. Open ended questionnaires and prompt sheets were used to determine the interviewee's perception of project design, implementation and impact. Interviews were held with; representatives of donor agencies; Government officers and extension workers; project managers; builders and well sinkers; community leaders and councillors; and individuals of the community.

c) Site Visits and Technical Inspections

Each of the project areas was visited and a technical inspection of a sample of the facilities (latrines, wells and boreholes et cetera), provided under the project carried out. Samples of the inspection protocols that were used are shown in Annex 2. These

Table 13.

Mix of Evaluation Techniques for Each Project

Evaluation Techniques							
Project	Document Review	Data of Other Evaluations	Principal Informants	Field Visits	Technical Survey	MEP Survey	Case Study
MOH Pilot Projects	X	-	X	X	X	X	-
Masvingo GTZ W&S Project	X	X	X	X	X	X	-
UNICEF Wells Project	X	-	X	X	X	X	X
LWF Wells Project	X	X	X	X	-	-	-
CSSD W&S Project	X	-	X	X	X	X	X
Chilimanzi W&S project	X	X	X	X	-	-	-
DANIDA W&S Project	X	X	X	X	X	-	-
NORAD W&S PROGRAMME	X	X	X	X	X	-	-
SCF W&S Project Binga	X	-	X	X	X	-	X

protocols were a modification of those developed for use in Botswana during a technology development project, sponsored by the Government, and the International Development Research Centre of Canada (Boydell, 1978).

d) Questionnaire Surveys of Utilization and Functioning of Facilities

Broad sample surveys of the utilization and functioning of facilities provided through the projects were carried out using closed questionnaires developed by WHO as a Minimum Evaluation Procedure (MEP) for water supply and sanitation projects (WHO, 1983a). MEP surveys and technical inspections described above were generally combined and carried out at the same time by survey staff comprising health assistants, undergraduate students or similar. The WHO Minimum Evaluation Procedure is described and sample questionnaires shown in Annex 1.

e) Micro Case Studies

In line with the evaluation principle of "listen to the people", used in the project evaluation techniques developed by Salman (1983), data and information were gathered in open ended interviews, discussions and observations in order to construct limited or micro case studies. These sought to describe the interactions between a discrete community and a project activity, for example, the construction of a well or the building of a small group of latrines. These micro case studies were carried out by local enumerators who lived within a community. They were carried out over a number of weeks in order to develop the communities trust and a clear understanding of the communities perspective on the project and donor. These micro case studies were particularly useful in fleshing out the statistical data of the broader surveys.

7.6 Data Collection and Analysis

Collection of data from interviews, questionnaires

and the technical inspections was carried out by local enumerators, mainly MOH Health Assistants or undergraduate students from the University of Zimbabwe, who were fluent in the local languages of Shona and Ndebele. The HAS were trained in one day long seminars and trial run exercises. The micro case studies were carried out by a post graduate student also from the University, supervised by the author. Whereas, the majority of principal informant interviews with donors and project designers and managers were carried out by the author. Analysis of data collected in technical inspections and MEP surveys of the MOH pilot projects, the GTZ programme in Masvingo and the CSSD project in Mashonaland were carried out by hand, whereas data collected in the evaluation of the UNICEF wells project was carried out using a desk top computer and a standard statistical programme.

7.7 Project Design Analysis

Project design evaluation was undertaken using a logical framework approach as the analytical tool. Late in the 1960's the United States Agency for International Development (USAID) evaluated a number of their own community based projects and found that many were not achieving the goals identified in the original project designs. In response USAID commissioned a consultant - Practical Concepts Incorporated (PCI) - to further investigate this problem. It was discovered that, at the planning stage, few, if any, project designers could logically relate expected project outputs to the proposed inputs. PCI then went on to design a simple planning technique and analytical tool, "The Logical Framework", (PCI, 1969) which has been adopted by a number of donors. The technique forces the project designer logically to relate proposed project inputs to expected outputs and to set these against measurable indicators, fixed constraints and assumptions. The logic is presented in a matrix; the concept and examples of which are given in annex 3.

- o 0 o -

Chapter 8

St. Theresa's Mission Water Supply and Sanitation
Project in Chilimanzi

- o 0 o -

1

Chapter 8

St. Theresa's Mission Water Supply & Sanitation Project in Chilimanzi

8.1 Background

a) General Description

Dominican Sisters based at St. Theresa's Mission Hospital in Chilimanzi Tribal Trust Land (now known as Takawira Communal area), have promoted communal self help construction of water supplies and sanitary facilities in the catchment area surrounding the hospital. The project which commenced in 1975, five years before independence, grew from follow up visits to patients discharged from a nutrition centre when it was noted that water was often being hauled from great distances by many villagers. In the project, water was provided from shallow wells fitted with hand pumps; the sanitation technology was an improved pit latrine. Health and hygiene education were also components of the project, together with pump manufacture and maintenance (MEWRD-NMPRWSS, 1985).

Chilimanzi which is located in Midlands Province has a population of approximately 55,000 living in an area of some 104,000 hectares.

b) The Donor

St. Theresa's is a Catholic Mission Station that has been established in the Chilimanzi area for a number of years. The main activity of the mission has been to run a small district hospital. The mission, which is staffed by Dominican sisters, is linked through the Catholic Bishops Conference to the Commission for Social Services Development (CSSD, 1984 also see chapter 9), from where they can request financial support for projects. The mission also has channels back to its parent organization in Europe from where addition project funds can be obtained.

In parallel with the Dominican Mission, a Jesuit Brother House was also established in the area. They in turn established the Budirirai youth skills training centre. The RWSS project, which was led by Sister Pat Walsh, assisted by Brother Charles (who was particularly involved in hand pump assembly installation and maintenance), has had some notable successes and has had a significant impact on the process which led to the development of a national approach or strategy for RWSS (St. Theresa's, 1985).

c) The Development of the Project

In 1975 an evaluation and follow-up of patients, mainly children, discharged from a Nutrition Rehabilitation Centre based at St. Theresa's Mission Hospital was carried out. On visiting communities, it was noted that water was often hauled from two to three kilometers away from the homes and used predominantly for domestic use (not vegetable growing as was expected). It was also found that facilities for disposing of excreta were not available. All this negated much of the nutrition and hygiene education that had been given at the centre, for example, growing the correct foods, hand washing after using a latrine et cetera. Also when asked about their priority needs the communities expressed a strong desire for improved and more convenient water sources (Walsh, 1985).

The findings of the evaluation were discussed with the hospitals advisory committee and it was agreed that the hospital should launch an outreach project to provide clean water for communities in the area. It was also agreed that, at that time, latrines should not be constructed as a demand was not apparent. Over a six month period meetings were held with community leaders in order to design a suitable project. After long debate on issues ranging from type of pump to community contribution the approach was agreed and project execution commenced (Walsh, 1985).

The Mission was opportunistic in using any available meeting or discussion forum to inform the entire population of the area about the project and to mobilize community

see
top p 150
↓
with
Whom?

Leuk

leaders. By 1979 the number of protected wells fitted with hand pumps in the area was increased from 4 to over 300. However, in 1979 the project was temporarily abandoned due to a worsening of the security situation in the area (St. Theresa's, 1985).

Soon after independence in 1980 the project was revived and became the subject of an independent evaluation by a University of Zimbabwe student whose comments had significant influence on the project, particularly in introducing the idea of forming community groups for pump maintenance, even though this was not implemented (Matindike, 1982). Another significant change was that a sanitation component was introduced. Initial discussion with the community confirmed that communal latrines were not acceptable and that the programme should concentrate on the promotion of family latrines. The project actively continued until 1984 when activities slowed down particularly after Sister Walsh was reassigned.

d) Objectives and Target Groups

The overall objective of the project was to provide what was considered to be a missing component of a broad primary health care programme, that is, protected and convenient water supplies together with excreta disposal facilities, in order to optimize the efforts that were already being made in nutrition, immunization and hygiene education and thereby improve the health standard of rural dwellers. It was felt that improved water supplies would stimulate better small scale agriculture and thereby improve nutritional standards. A secondary objective of the project was to demonstrate the use of ultra low cost technologies that could be fully adopted by the communities allowing the mission to withdraw from the programme some time in the future.

Of the rural dwellers the primary target group was women particularly as recipients of the nutrition and hygiene messages and for mobilization to provide labour and to form maintenance groups. Men and political leaders were

involved more in the decision-making process of accepting and planning the project.

e) Integration of Water, Sanitation, Health and Other Sectors

Water and sanitation were seen as an integral component of a health programme and essential to ensuring the success of the other components. However, neither water nor sanitation was seen as a component of a broader development approach, other than as a component of small scale agriculture. Water and sanitation were developed sequentially, with water having the highest priority and sanitation following along at a later stage.

f) The Extension Strategy

There was no formal extension strategy developed during the project. However, two principles were maintained, firstly that community leaders should be involved in planning the activity and secondly, that the communities themselves should provide substantial inputs to the construction of the facilities. The mission provided only essential materials that were unavailable or unobtainable, for example, cement and hand pumps. Communication was effectively achieved through a series of discussion groups held at a number of levels. Mobilization mainly of women was effected through discussions held during visits of the mobile maternal and child health (MCH) clinic to community groups. This was supplemented by discussion held at the nutrition centre and household visits by VHWS employed by the project. At a higher level more formal discussions took place with community leaders such as councillors, teachers, health assistants et cetera, in order to obtain their endorsement and to bring them into the planning process. It was also felt that technical assistance and training inputs were required to achieve good standards of construction and installation of the facilities; this was achieved through the employment of field supervisors.

The community, under the leadership of a visiting VHW,

formed groups of ten families who were expected to dig the well (and later latrine pits), and collect materials such as sand and stones. They then collected cement and the pump and completed the installations with the guidance of the field supervisors. The VHW would follow up with further hygiene education visits (Walsh, 1985. St. Theresa's, 1985).

- Last part of report can be deleted
g) The Present Status

By 1985 over 300 wells had been constructed and fitted with hand pumps although many are now dry due to a lowering of the water table during the drought. Also over 1,000 latrines have been constructed although many are incomplete mainly lacking roofs. Assuming a service level criteria of 1 latrine per 10 persons and 1 well per 100 persons the project has achieved a coverage of 85% for water and 30% for sanitation. The project is now halted (MEWRD-NMPRWSS, 1985).

Don't reflect in 1987 report. Review

8.2 Planning

a) Base Line Data and Feasibility Studies

No surveys or feasibility studies were carried out. As the mission and hospital had been active in the area for many years the sisters had developed a good community insight and felt that the time was 'ripe' for the project.

b) Project Planning

The project did not have a formal plan which defines numbers of latrines or wells to be constructed over a specific time period. However, a general procedure was formulated with community leaders together with an agreement as to what inputs should be provided by each of the two participating bodies.

c) Community Participation in Planning

The community as a whole were not involved in the conceptual planning of the project. This was done jointly by the mission and community leaders as described above and

the degree of referral from the leaders to the "masses" appears to have been limited. However, the involvement of all the community may have been impractical and generally the leaders represented the community's views and interests in good spirit. The direct input of the community in the planning of the project were made at the level of choosing the well and latrine sites and organizing the labour and local materials.

d) Choice of Technology

The Chilimanzi Project played a significant role in Zimbabwe's technology development. In the mid 1970's the Blair Research Laboratory used the area as a testing ground for new pump designs, including the early versions of the Blair Hand Pump. This association with Blair continued throughout the project (Morgan, 1986). Therefore, as in most RWSS projects in Zimbabwe, the choice of technology was almost preordained. Safe water is provided through the construction or improvement of existing shallow wells that are fitted with Blair hand pumps. The pumps were assembled on site at the Budirirai Training Centre workshop from locally available PVC pipes. The latrine design adopted is a spiral Blair Latrine constructed of burned bricks and a thatched roof fitted with a ventilation pipe made from plastered wooden poles formed into a tube. In the later part of the project, after the water table was observed to be dropping, a hand auger was brought into the area in order to drill shallow tube wells up to 15m deep. The auger had only limited success. The project avoided involvement in other sophisticated water development techniques such as mechanized bore hole drilling.

8.3 Implementation

a) Donor, Community and Government Inputs

The contributions provided to the project by the three participating groups were:

St. Theresa's Mission provided: the catalyst for the

project; funding for the various activities and support costs; difficult to obtain materials for construction including cement (3 bags for each well and latrine to be constructed); hand pumps and a fly screen for the latrine ventilation pipe; training for builders and pump maintenance; technical assistance through field supervisors; hygiene and health education through VHWs; various equipment including a lorry and pickup truck.

The Community provided: locally available materials for the construction of the wells and latrines including sand, stone, thatching grass and timber; labour for transporting materials and construction. Occasionally a family would employ a builder to construct a latrine for them; the community also formed pump maintenance groups.

Government provided: limited manpower support through the one health assistant assigned to the area and toward the later part of the project through VHWs; also technical advice and training was provided through the Blair Laboratory (St. Theresa's, 1985).

b) Institutional Relationships and Managerial Arrangements

There was very little contact between the Mission and the provincial or district administration in respect of the project, particularly in the earlier years. However, as the MOH's extension network grew after Independence, some support was provided by staff assigned to the area, indeed the mission took up a supervisory role for these staff who were somewhat adrift. The project was managed from the Mission Hospital, the activities being absorbed into the day-to-day administration. Sister Walsh was the coordinator. However, management and planning functions were quite informal. At the height of the project five field supervisors were employed full time to provide guidance and supervision of construction. Thirteen VHWs who had been trained by Oxfam before the Government's VHW programme became effective assisted in mobilization and educational activities. At the nearby Budirirai Training Centre which is managed by the Jesuit Brothers, Brother

Charles led student groups in assembling Blair Pumps, casting concrete pump installation collars, and assisting the communities in the installation of pumps on the wells.

c) Communications

Communications within the project can be considered in three categories; creating awareness and initial planning; community mobilization and education; and technical assistance. Creating project awareness in community leaders and initial planning was undertaken simultaneously. Meetings were held with councillors, teachers, the local health assistant, and traditional leaders et cetera, during which the whole concept of the project was agreed, including what should be the timing, responsibilities, and contributions of the Mission and community groups. At a second level mass awareness was created at gatherings such as political rallies of which there were many after independence. Community mobilization and health/hygiene education were mainly effected through visits of the VHWS to community groups where discussions took place mainly with women. Other venues such as the visits of the mobile clinic or outpatients at the mission hospital were also used for discussions.

Technical assistance was provided in three ways: by the Blair Laboratory which provided two or three short training courses for field supervisors in well and latrine construction and pump assembly and maintenance; the field supervisors who assisted communities in the actual construction of the facilities during ad hoc visits as were seen necessary; and students from the youth training centre who assisted in the installation and subsequent repair of the hand pumps as each well was completed or fell into disrepair (Walsh, 1985).

d) Credit and Finance

Credit facilities were not provided to the community nor was the recovery of costs attempted. The project funds used by the Mission were provided from external charitable

sources. Costs were reported to be approximately Z\$60,000 per year of which one-third was used to purchase the materials supplied to the communities, the remainder being used for operational costs. All the Mission overhead costs such as salaries were discounted from project accounting. Other unaccounted costs were Oxfam's funding of the Nutrition Centre and other charitable funding of the Budirirai Youth Training Centre workshop.

8.4 Findings and Results

a) Achievements of Goals and Objectives

As specific goals and objectives had not been established for the project other than generally improving water and sanitation in order to optimize other health interventions, it is difficult to discuss achievements. In terms of numbers of facilities built, or service level, it would seem that the reported improved coverage of 85% of people having access to a nearby protected water source in the area and 30% having sanitary facilities is a significant achievement, particularly as this was accompanied by supporting educational inputs. However, the longer term sustainability of the project should be questioned as many of the wells have fallen into disuse and many of the latrines remain incomplete. Also the increased access to water apparently had little or no effect on increasing small scale agricultural activity

b) Acceptance, Use and Performance of Technology

The Blair Hand Pump and Blair latrine, that were the standard technology used in the project, were generally well accepted by the users. It was found that in the case of latrines construction, standards were poor and a number of latrines were incomplete many lacking roofs or fly screens. However, they were being used and adequately maintained. Similarly many of the wells were poorly constructed and incomplete, many lacking aprons and many having dried up due to being too shallow combined with a

falling water table. The earlier models of the Blair Pump suffered from numerous breakdowns although they were promptly repaired by Brother Charles. Later pump models were more robust (St. Theresa's, 1985).

c) Maintenance, Cost Recovery and Replicability

Cost recovery was not attempted in any form and the prospect of large scale replication, or even of the present project being sustained, is poor. The level of resource necessary and external support required not being available. Maintenance and repair of hand pumps was done on an ad hoc basis in response to community demand; villagers carried pumps to the Budirirai Centre for repair. However, in reaction to comments made during an external evaluation (Matindike, 1982) which decried the lack of community involvement in maintenance, the Mission proposed to train community based pump caretakers and to encourage groups to establish funds in order to buy spare parts. This did not materialize.

d) Institution Building and Effects on Policy

The project had significant effects on the development of sector policy in Zimbabwe in two ways; the concept of the donor providing difficult to obtain or unaffordable materials, such as cement and pumps, with the community providing labour and locally available materials was adopted by Government (see MOH Pilot Projects) and later by other donors as a standard approach. Secondly the project played a role in technology development being in effect a testing ground for the Blair Laboratory; much of the field trials of the Blair pump and the low cost latrine designs were being carried out in the area. However, the project had little governmental or institutional capacity building, or broader community development effects.

e) Project Design

There was no formal project design and the disadvantage of not having a logical and systematic plan of operations

can be seen; the unfinished latrines were in part due to an unfounded assumption that thatching grass would be available; the low standards of well construction were due to poor technical support; also the sustainability of the project was not assured by involving the community more in the longer term pump maintenance needs; no project inputs were planned or made in order to stimulate vegetable gardening which was one of the project objectives. Conversely, the concept of community involvement in planning from the conceptual stage was a positive feature of the project.

f) Other Factors

The dedication of Sister Walsh and Brother Charles were clearly major factors in the successes of the project. Also the well established presence of the donor in the community had formed a trust relationship which is essential in a project where the partners' contributions are interdependent in order to achieve success. The long lead time during which discussions took place with community leaders also clearly paid dividends. Finally the independence of the programme from rigid structures clearly had benefits that are balanced by a loss of internal efficiency of operations.

yes

8.5 Lessons to be Learned from the Project

A summary of a systems analysis of the project is presented in table 14 and depicted in figure 10. There are a number of valuable lessons that can be learned from St. Theresa's project. First, the ability of an NGO to establish effective communications with a community in order to execute a participatory development project, and the flexibility of an NGO in the management and support of such an activity, and furthermore, that Government does not necessarily have a direct role in this. Second, the critical importance of the community participating in the decision-making regarding their inputs to a project. Other

lessons include the role of charismatic team leadership, the effectiveness of communications when water and sanitation are linked with health and the importance of women as targets in extension activities. There are also some negative lessons related to project design, a key component of the project delivery strategy was the removal of constraints to self help construction by providing essential materials unavailable to the community such as cement. However, projects must be logically designed such that the expected outputs are attainable given the inputs. This was not the case, insufficient cement was provided to complete the latrine roofs and thatch was not available. Furthermore, the project was neither self sustaining nor widely replicable for want of a maintenance structure, and for lack of recovery of the investments. From a broader perspective the necessity of long lead times and pilot projects or proving grounds where technologies and strategies are developed and tested is clearly seen in St. Theresa's project which had a fundamental impact on subsequent project design and technology development in Zimbabwe. Finally it should be noted that the departure of Sister Walsh which marked the effective end of the project clearly indicates the of training for leadership succession.

Table 14.Summary of Systems Analysis of St. Theresa's Project1. Systems Present and Their Function

A donor who managed the project; a community who participated and were beneficiaries; and Government who played a peripheral advisory role.

2. Actors and Their Roles

Donor: St. Theresa's Mission the NGO which was the project focal point; the project manager; field workers who supervised activities; health workers who communicated with the community.

Community: traditional leaders; womens groups at the clinic who were targets for promotion; local builders who constructed wells and latrines; and local youth who assembled and installed pumps.

Government: Blair Laboratory who advised on technology; health assistants who helped in field activities.

3. Leaders and Accountability

Donor: Sister P Walsh who had limited accountability to her mission superiors and financiers.

Community: Traditional leaders who had limited accountability to the community.

Government: Dr Morgan who had no significant accountability.

4. Perceptions and Self Interest

Donor: That water would improve health and that the NGO had some responsibility for its provision.

Community: to maximize the materials grant from the donor in order to improve their living standards.

Government: the need for technology development and testing.

5. Goals and Criteria of Achievement

Donor: unspecified health improvement and number of wells and latrines constructed.

Community: continuous water supplies.

Government: well functioning pumps.

6. Problem Definition and Solution

Donor: by the leader.

Community: problems and solutions were not defined internally, however traditional leader contributed to the donors analysis.

Government: by the leader.

7. System Interaction and Boundary Spanning

The interaction between the donor and Government systems was on the basis of the personal contact and relationship of the two leaders. The interaction between the donor and community systems was at two levels with leaders meeting at rallies, and with women and health workers meeting on day visits.

Table 14 Continued8. Commonality and Conflict

The commonality in all three systems was the appreciation of a need for improved water supplies. However, conflict arose as to what were the roles and responsibilities particularly of the donor and the community during construction.

Other Evaluation Criteria

9. Project objectives clearly defined?.....No.
10. Sufficient resources allocated?.....No.
11. Any baseline or feasibility studies?.....No.
12. Links established to other sectors?.....Yes - health.
13. Productive capacity improved?.....No.
14. Role of technical assistance and NGOs?.....An NGO was the primary force in the project.
15. Role of Women?.....The focal point for the health education and promotion.
16. Role of private sector?.....Local builders constructed the wells and latrines.
17. Appropriate technology used?.....Yes.
18. Health/Hygiene education provided?.....Yes.
19. Any costs recovered?.....No.
20. Any monitoring and evaluation?.....Only hand pump performance,
21. O & M provided for?.....No.
22. Identifiable project phases?.....Yes - promotion, construction and integration.
23. Any role on effects?.....Yes - the project had major impact on subsequent project designs.
24. Water sanitation and education integrated? Yes.

Figure 10. Systems Diagram of St. Theresa's Mission Project.

Donor System

Actors:-

- The NGO - St. Theresa's Mission hospital and youth training centre.
- The project leader.
- Field workers.
- Health workers.

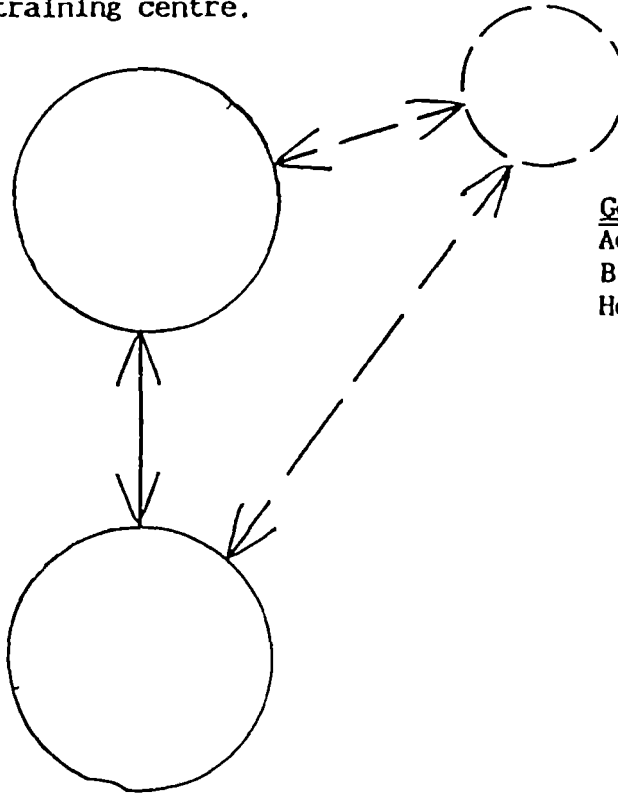

Government System

Actors:-

- Blair Laboratory.
- Health assistants.

Community System

Actors:-

- Traditional leaders.
- Women groups at nutrition & MCH clinics.
- Local builders.
- Youth.



- o 0 o -

Chapter 9

The Commission for Social Services Development
Water Supply and Sanitation Project in Mashonaland

- o 0 o -



Chapter 9

The Commission for Social Services Development Water Supply and Sanitation Programme in Mashonaland

9.1 Background

a) General Description

The Commission on Social Services Development (CSSD) RWSS programme, was a strong component of a broader rural development programme that has been particularly successful in the Mashonaland area of northern Zimbabwe. Water supply and sanitation service levels continue to be improved in communal areas through a community based self-help programme supported by extension services provided by the NGO, CSSD. Small agricultural cooperatives are the focal point of the programme that also includes adult literacy, health, and small enterprise development (MEWRD-NMPRWSS, 1985).

b) The Donor

CSSD is a small national NGO formed under the Zimbabwe Catholic Bishops Conference. It is also a member of the International Working Group for Socio Economic Development based in Brussels and of Caritas International. With these international linkages, CSSD attracts funding from a number of external sources. It has a national administration based in the Archdiocese of Harare and programme coordinators, together with extension and support staff, in each of the five dioceses. Although the agency supports RWSS activities over the whole country, by far the most successful activity in terms of numbers of wells and latrines constructed is the programme in the Chinhoyi Diocese in Mashonaland which is led by Programme Coordinator Dianna Auret. In 1986 CSSD assumed a new title, the Catholic Development Commission or CADEC. Throughout this text the earlier and more commonly used acronym CSSD is used (CSSD, 1983).

c) The Development of the Programme

CSSD have been active in Zimbabwe since before Independence. During the 1960s and early 1970s they supported small scale agricultural development aimed at peasant farmers in the then Tribal Trust Lands mainly as outreach activities from the network of Roman Catholic Missions that had proliferated in the rural areas of Rhodesia. The sixteen or so mission stations that exist in the area, which may typically consist of a school or clinic attached to a nunnery, form a solid foundation for the programme. The basic approach adopted (and still maintained) by CSSD toward agricultural development and thereby broader rural development was the formation of small farmers' cooperatives consisting of ten or so family groups who were encouraged to band together in order to optimize their labour, marketing, and purchasing power. However, during the Independence struggle, much of the social infrastructure of the rural areas was disrupted, many of the farmers were resettled in the so called 'protected villages', and consequently the activities of CSSD were limited. After Independence they accelerated their activities to even higher levels in a rural reconstruction programme which included the reformation of the farmers' cooperatives in the Communal Areas with the cooperatives being given credits of seed and fertilizer. The reconstruction programme rapidly evolved into a rural development programme with components of water and sanitation, primary health care, adult literacy, small enterprise development, and drought relief (between 1984 and 1986), along with the continuing support to agriculture. Over the years CSSD have established a remarkable rapport with the rural communities based on trust, integrity and consistency (CSSD, 1984/87).

d) Objective and Target Groups

The overall objective of the programme was to improve health and accelerate economic and spiritual development of the peasant farmers in communal areas. Of this target group

it has become clear that women are the most receptive and active participants in some specific components of the programme; particularly adult literacy, hygiene education, and small scale enterprise development such as sewing and beer brewing clubs. Whereas men, who are the decision makers regarding the organization of agricultural activities and marketing of produce, are the target for the more general promotional messages leading into agreeing to form a contract with CSSD.

e) Integration of Water Sanitation Health and other Sectors

The basic assumption in the implementation strategy was that water, sanitation and hygiene education must go together in order to obtain maximum health impact and that these are one of a number of components needed in a broad approach to rural development. It was also felt that the starting point for this development process was the formation of agricultural groups at which these developmental initiatives could be focussed (CSSD, 1984/87).

f) The Extension Strategy

The extension strategy was to superimpose a number of development interventions onto the existing or recently formed agricultural cooperatives. RWSS was promoted at two levels, at mass meetings, political rallies or field days. The benefits of improved water supply and sanitation were promoted in speeches and examples of well constructed latrines and wells were demonstrated. In parallel, at a lower level, CSSD extension workers visited community groups and through community awareness group discussions a list of development priorities was established which often included water supplies and sanitation. The community then entered into a contract with CSSD for the supply of essential materials, mainly cement and a pump, the costs of which were to be paid back. The community then formed a committee or adapted an existing committee to coordinate the development effort of the group including the choosing

of a local builder who would be trained by CSSD in locally organized short courses organized by the donor to construct wells and latrines. The community provided other materials and unskilled labour for the construction of a well and between five and ten pit latrines. Extension workers from CSSD made follow-up visits to provide technical assistance and gave hygiene education talks (Boydell & Chingono, 1986a).

g) The Present Status

Up to the end of 1986 some 700 Blair improved pit latrines had been constructed together with 100 or so hand dug wells in the Chinhoyi Prefecture . This represents the outputs of completed agreements or contracts with 120 or so agricultural cooperatives. An equal number of cooperatives are presently constructing more facilities under new contracts with CSSD (MEWRD-NMPRWSS, 1985).

9.2 Planning

a) Base Line Data and Feasibility Studies

As the programme had evolved over a number of years specific base line data was not collected nor were formal feasibility studies carried out. However, based on long experience CSSD claim to have a good insight as to when specific components of their programme should be introduced into a community.

b) Project Planning

The programme did not have a formal operational plan in the managerial sense but may be considered as the 'rolling over' of a series of community agreements, with the turn over finding its own dynamic rate based on community demand and the capacity of CSSD. At any one time up to 200 community agreements have been in force.

c) Community Participation in Planning

Community participation in planning begins at the community group level. The community was not involved in the national provincial or district level decisions regarding the design of the programme (what little formal design exists). The first of the micro level decision for the community being whether to participate in the programme or not. Other community decisions are: who should be nominated for builder training; where the wells and latrines are to be sited and in which order should they be constructed; who should be members of the water committee and which offices should they hold? The water committee usually consisted of two or three women who were designated as the pump minders. The community also provided a water diviner who assisted in siting the well (Boydell & Chingono, 1986a).

d) Choice of Technology

As in the other projects, technology choice in Zimbabwe is almost preordained. Spiral Blair latrines constructed of burned bricks and equipped with a PVC ventilation pipe are specified as the standard. Water supplies are developed by digging shallow wells which are equipped with Blair Pumps. More recently a hand auger has been used in the project with limited success to drill shallow tube wells. The project deliberately does not become involved in the more sophisticated water development techniques such as mechanical bore hole drilling or sinking deep wells by blasting (Morgan, 1985/87).

9.3 Implementation

a) Donor, Community and Government Inputs

The inputs provided to a project by the three participating groups were;

CSSD provided: the catalyst for the formation of the cooperatives; difficult to obtain materials for construction including cement (3 bags per latrine and 7 per

well), reinforcement, ventilation pipes and hand pumps as a loan, the cash value to be repaid; training courses for builders and on pump maintenance; technical assistance and hygiene education; two hand augers were also available for use.

The Agricultural Cooperative provided: locally available materials including sand, stone, timber, thatching grass and fire wood; labour for brick making, building and the maintenance of the pump; and a small contribution to the salary of the field officer, some Z\$2 per month. The community also repays the materials loan.

Government provided very little other than support in promotion and extension work by locally based Health Assistants and support in hand pump maintenance courses from the Blair Laboratory (CSSD, 1984/87).

b) Institutional Relationships and Managerial Arrangements

A good relationship was established between CSSD and the provincial and district administrations who were quite happy to see CSSD assume some of their responsibilities. CSSD participated in planning meetings and were considered to be a good technical and material resource. Often CSSD have taken up a supervisory role of Government's Health Assistants and Village Health Workers who were sometimes a little adrift because of infrequent supervision. However, at national level their role was perceived differently; they were seen by some to be interfering and providing an alternative to Government which was thought to be a threat and a criticism.

CSSD manage the programme at provincial level with a coordinator, four field promoters, and one literacy promoter. They were assisted by ten or so extension workers based at district level (the cooperatives contribute to the salaries of the district extension workers). Monitoring the programme was the responsibility of the extension workers who prepared monthly progress reports. However, the cooperative was required to provide progress reports after three and six months and at completion. It was expected

that the project would be completed within twelve months.

c) Communications

Communications within the project can be divided into five categories. Creating awareness of the programme in the districts; creating awareness of needs and priorities at community level, these two categories have been collectively termed "conscientizing the community" (CSSD, 1984/87); technical training and assistance; health and hygiene education; and developmental potential education. Once programme awareness had been established in an area, the field promoters visited individual cooperatives and held group meetings mainly with women. Discussions of picture-cards depicting village scenes took place as a catalyst for the listing of priority needs of the village. For water and sanitation development this then led into an agreement between CSSD and the cooperative. However, sometimes the male decision makers need additional motivation and CSSD reverted to stronger arguments related to status and privacy. "Do you men have no respect for your women, forcing them to defecate in the open fields where they can be seen by your neighbours?". This was a particularly strong argument as the area suffers greatly from deforestation. Other developmental needs were identified and responses are designed in a similar way.

Technical training was undertaken in ad hoc district level courses. One or two representatives from each new cooperative were brought to a central point where demonstrations of well and latrine construction were carried out. Separate hand pump maintenance courses were also held for the designated "pump minder". Follow up technical assistance and health education visits were made by the field promoters at regular intervals (Boydell & Chingono, 1986a).

d) Credit and Finance

CSSD established their own internal revolving fund of approximately Z\$250,000 from which funds were drawn to

purchase materials that were loaned to the cooperatives. A general criteria have been established that the loan would cover 75% of the project costs, the cooperative providing 25%. In the contract between CSSD and the cooperative, the material loans were expressed as an equivalent cash value to be repaid over three years. No further loans can be made to a group until the first one has been discharged. The total loan was in the order of Z\$600, with the repayments being in the order of Z\$20 per month which was used to replenish the revolving fund. The fund was also topped up from charitable contributions as required. Operating costs of vehicles, payments of salaries et cetera were drawn from a separate budget (CSSD, 1984/87).

9.4 Findings and Results

a) Achievements of Goals and Objectives

It is difficult to discuss the success of the project in terms of the achievement of specific numeric goals within a time frame as goals had not been established at the outset. However, the programme is clearly accelerating its provision of services. It would also seem that the more general developmental objectives are being achieved. Clearly CSSD are sensitive to and have tried to serve the needs of the rural farmers. In turn a significant number of cooperatives have responded to the development strategy of CSSD and are now better equipped in terms of service level, surplus cash, and capacity to undertake cooperative action for their own benefit (Boydell & Chingono, 1986a). No attempt has been made to measure health or economic improvement.

b) Acceptance, Use and Performance of Technology

The standard technology that was advocated in the programme, the Blair Latrine, the shallow hand dug well and Blair pump, were generally well accepted by the users. It was found however, that construction standards were rather

poor and that although over 90% of the latrines that had been constructed were being used and maintained, most had not been fully completed (eg. the roof was not provided). Similarly many wells were not fully complete, as aprons or drainage channels had not been constructed. Concerns were also expressed by the community regarding the Blair Pump which was thought not to provide enough water for the physical pumping efforts made. Another problem was that a number of the wells had dried up: this could have been avoided with better construction and design criteria. It was also found that over 85% of the community who were mature enough to participate in the programme had done so, although there was not a clear idea of who was responsible for repairing the pump should it break down (Auret, 1985).

c) Maintenance, Cost Recovery and Replicability

The recovery rate of the cooperative loans is low. Less than 30% of the groups have made full repayment. CSSD attribute this to the drought which has reduced agricultural production and cash surpluses. The maintenance of hand pumps has not been structured or formalized and is carried out on an ad hoc basis by the field promoters in the area or by the Government health assistant. So far the programme continues to be replicable on the small scale of the province. However, CSSD do not have the resources themselves to expand much beyond the present areas of activity.

d) Institution Building and Effects on Policy

Although the programme has been very responsive to community needs, it has had little effect on building the capacity of Government to undertake a similar function in the longer term. In effect by relieving Government of its responsibilities the programme has delayed Governments involvement. Also the programme has had little immediate effect on reshaping national policy. However, the demonstration effect may have some longer term impact.

e) Programme Design

As was stated earlier, there was no formal programme design. However, the need for a systematic and logical plan of operations became more apparent as the programme expanded. For example, the unfinished latrine roofs and well aprons are due to unfounded assumptions that thatching grass was available, or that sufficient cement had been provided. The poor standards of construction are in part due to lack of timely and effective support from the field promoters and the lack of a maintenance structure for the pumps was a glaring problem. Also better technical inputs are required particularly in well design and construction to avoid the wells drying up.

f) Other Factors

Clearly one of the major factors in the success of the programme was the dedication and energy of the coordinator Ms Auret who relentlessly drove the programme along, overcoming any obstacles that cropped up. Also the independence of the programme from the bureaucracy of Government allowed the flexibility to attract field staff with slightly better than average salary scales and to operate vehicles and purchase materials free from long winded procedures.

9.5 Lessons to be Learned from the Project

The summary of a systems analysis of the project is given in table 15 and depicted in figure 11. The lessons that can be learned from the CSSD project are similar to and reinforce those from St. Theresa's project discussed in chapter 8. Namely, the ability of an NGO to establish effective communications with a community in order to execute a project and the flexibility of an NGO in the management and support of these activities. Also, the critical importance of community participation in the decision-making with regard to their inputs to a project, the role of charismatic leadership, the importance of women

as targets in extension activities, and that governments do not necessarily have a role in this. However, it is important to note that an effective partnership can be established with the NGO acting as an agent for a government and participating in broader regional development planning and implementation. It should also be noted that there were three key component in the project delivery strategy adopted by CSSD. First, the removal constraints to self-help construction by providing essential materials unavailable to the community, mainly, cement and plastic latrine ventilation pipes. Second, the linking of water and sanitation activities to existing agricultural cooperatives or farmers groups, and third, the use of a revolving fund, which provided credit and recovered some of the capital investment. Additional lessons are the long lead time required for projects to become effective and the use of standardized and institutionalized technologies, for example, the Blair latrine and pump. The CSSD project which borrowed much from and improved upon the project strategy developed at St. Theresa's had a significant effect on the design of the post Independence MOH pilot projects.

Table 15.Summary of Systems Analysis of the CSSD Project1. Systems Present and Their Function

A donor who managed the project; a community who participated and were beneficiaries; and Government who played a peripheral advisory role.

2. Actors and Their Roles

Donor: The Commission for Social Services Development an NGO which was the project focal point; the project manager; and field workers who promoted and supervised project activities.

Community: traditional leaders; farmers cooperatives which were the social unit with which agreements were made; womens literacy groups which were targets for promotion; and local builders who built wells and latrines.

Government: Blair Laboratory who advised on technology; health assistants who helped in field activities; and the district planning team who formulated district development plans.

3. Leaders and Accountability

Donor: Mrs D Auret who had limited accountability to her diocese and financiers.

Community: Traditional leaders who had limited accountability to the community.

Government: Dr Morgan who had no significant accountability, and the planning team who were accountable to the Provincial Government.

4. Perceptions and Self Interest

Donor: That water scarcity was a major health problem and that the NGO had some responsibility for its provision. That working with community groups was an effective strategy in solving this.

Community: to maximize the materials loans grant from the donor in order to improve their environment and living standards.

Trust of the donor based on previous experience.

Government: the need for technology development and testing, and structured district planning.

5. Goals and Criteria of Achievement

Donor: unspecified health improvement; number of wells and latrines constructed; and number of loans made.

Community: continuous water supplies.

Government: well functioning pumps, and a well defined local plan.

6. Problem Definition and Solution

Donor: by the leader.

Community: problems and solutions were not defined internally, however literacy groups were assisted in analyzing their community needs.

Government: by the leader in the Blair Lab. and the district team.

Table 15 Continued7. System Interaction and Boundary Spanning

The interaction between the donor and Government systems was on the basis of the personal contact and relationship of the two leaders and the district team. The interaction between the donor and community systems was at two levels with leaders meeting at rallies, and with women and health workers meeting on day visits.

8. Commonality and Conflict

The commonality in all three systems was the appreciation of a need for improved water supplies. However, conflict arose as to what were the roles and responsibilities of the three groups. Particularly, the role of the donor and the community during construction, and Governments somewhat negative perception of the donor.

Other Evaluation Criteria

9. Project objectives clearly defined?.....No.
10. Sufficient resources allocated?.....No.
11. Any baseline or feasibility studies?.....No.
12. Links established to other sectors?.....Yes - health, agriculture and education.
13. Productive capacity improved?.....Yes - project was linked to agricultural groups.
14. Role of technical assistance and NGOs?.....An NGO was the primary force in the project.
15. Role of Women?.....The focal point for needs awareness generation, health education and promotion.
16. Role of private sector?.....Local builders constructed the wells and latrines.
17. Appropriate technology used?.....Yes.
18. Health/Hygiene education provided?.....Yes.
19. Any costs recovered?.....Yes.
20. Any monitoring and evaluation?.....Yes - project effectiveness study using MEP and hand pump performance,
21. O & M provided for?.....No.
22. Identifiable project phases?.....Yes - promotion and construction.
23. Any role on effects?.....Yes - the project had major impact on subsequent project designs.
24. Water sanitation and education integrated? Yes.

Figure 11. Systems Diagram of the CSSD Project.

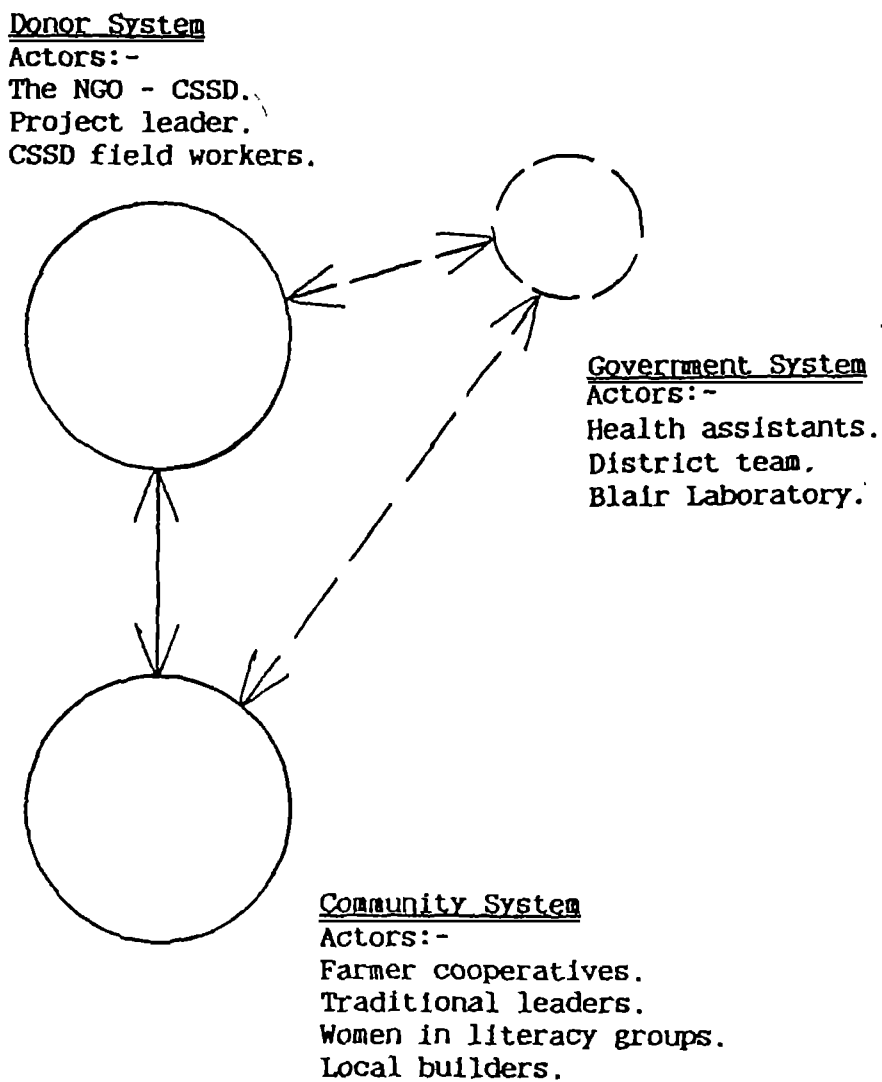

- o 0 o -

Chapter 10

The Ministry of Health Pilot Projects in
Mhondoro Serima and Zimutu
and
The Subsequent MOH Expanded Programme

- o 0 o -



Chapter 10The Ministry of Health Pilot Projects in
Mhondoro Serima and Zimutu
and
The Subsequent MOH Expanded Programme10.1 Backgrounda) General Description

After Independence, Government's first major RWSS projects other than the DDF reconstruction programme were three large pilot projects launched in separate communal areas; Mhondoro, Serima, and Zimutu. The projects which were executed by the MOH grew from the concept of establishing pilot areas for the development of an integrated primary health care programme of which water and sanitation were seen as the main component. This was part of the post Independence shift from curative to preventative medicine (ROZ, 1981). Much of the water and sanitation implementation strategy was based on the experiences of the NGO project in Chilimanzi. The water and sanitation component outgrew the other health interventions and rapidly grew to a national scale without the need for completion of the pilot schemes. Coincidentally, the Department of Physical Planning in MLGRUD also saw Serima as a pilot area for an integrated rural development model based on agricultural and other socio economic reforms and interventions (Dept. of Physical Planning, 1982). Donor funding was obtained for Mhondoro and Serima and the projects launched in 1982. Zimutu was also launched in the same year funded from domestic sources. In the projects water is supplied from wells or hand augered tubes fitted with hand pumps, excreta disposal facilities were provided by improved pit latrines.

In general the pilot projects have led to the formulation of a national strategy for RWSS that was

detailed in the NMPRWSS and which has been adopted by almost all the donors and NGOs active in the sector (MEWRD-NMPRWSS, 1985). Furthermore, the Serima project was developed into a province-wide programme and is a strong component of a model integrated rural development programme in the Gutu District of Masvingo which is described later. Mhondoro, located on the south of Mashonaland West Province, is a large communal area divided into three wards and occupied by some 60,000 peasant farmers. Serima and Zimutu are smaller CAs located in Masvingo Province and have populations of 8,500 and 13,000 respectively.

b) The Donors

Mhondoro was funded from a grant provided under the EEC Micro Project Fund. EEC micro projects provided funds in US\$150,000 allocations for community development projects where government and/or the community involved provided an equivalent amount in cash or labour and materials. The fund was administered at country level, and was free from the lengthy approval process of regular EEC development projects administered from Brussels (EEC, undated). The EEC resident mission kept a close watch over the progress of the project through regular site visits and reports from the MOH (EEC, 1984/87). The Serima project was funded by the British based NGO War on Want, who provided a cash grant against a project proposal. Their only requirement was to receive annual progress reports (Boydell, 1985b). For Zimutu a suitable donor could not be identified and it was decided by the MOH to fund it from domestic sources (MOH, 1984/87).

c) The Development of the Projects

The Mhondoro Project was initially slow to gain momentum. However, by mid 1984, some 2,500 latrines had been constructed. Water development was hindered by drought; the usually shallow water table dropped leaving many wells dry, and difficult to improve. During 1985 the drought broke and a hand auger was introduced into the

project in order to speed up the provision of water. In late 1985 a second micro project proposal was prepared by the MOH, and presented to the EEC who granted a further US\$80,000 to expand the project in the adjacent Ngezi CA (Boydell, 1985d).

The Serima and Zimutu Projects were also initially slow to gain momentum, however, by 1985 both areas had been almost covered with Blair latrines. Water development was less dramatic due in part to a declining water table caused by the drought. After the heavy rainfall during 1985 the situation improved and emphasis was placed on well sinking and protection. Both the projects were merged into a province-wide sanitation programme executed by the MOH, funded by GTZ, and Serima was absorbed into a model integrated rural development programme which is described in chapter 11. The pilot projects also led to the parallel development of a national water and sanitation programme executed by the MOH in each of the eight provinces funded from a mix of domestic and external sources.

d) Objectives and Target Groups

The project objectives were set out in the original project proposal. They were: to set up a pilot project for the installation of appropriate and low cost technology based water and sanitation facilities in selected districts and to evaluate its usefulness in eradicating water based diseases; to ensure adequate water for better hygiene; and to improve the general health of people. The target group was specified in general terms as the residents of communal areas (MOH, 1984/87).

e) Integration of Water Sanitation Health and Other Sectors.

Improved water supply, sanitation in the form of pit latrines and health education were seen as three inter-linked elements which made up one component of an integrated primary health care programme (Chambwe et al, 1982). However, water and sanitation were not initially

seen to be linked to a broader developmental approach. This concept was later developed, particularly in the Serima project, which was absorbed into the Gutu Integrated Rural Development Programme.

f) The Extension Strategy

The rural water supply and sanitation extension strategy was derived from the earlier NGO project in Chilimanzi and refined during the pilot project implementation. It may be summarized as follows: MOH subsidized the self help construction of Blair VIP latrines and hand dug or augered wells (or protected springs) by providing materials and the pump. The community provided other materials and constructed the facilities. MOH also provided other support including builder training, supervision of construction through the health assistants, assistance in mobilizing and organizing the community, and follow-up use and hygiene education through the VHWS (MOH, 1984/87).

In implementing this strategy the MOH had a flexible approach to using the resources available in a specific project area. Where a village health committee had been established and was active they became the focal point for community mobilization. Where none existed, efforts were made to establish a water committee. Other extension workers from MCDWA and AGRITEX were co-opted into the project where possible. Also, the emphasis of the project varied, in some areas the construction of demonstration latrines was the prime concern, whereas in other areas the training of builders was the main activity. This process of implementing this strategy is represented in figure 12, "A Generalized Model Project Cycle", (MEWRD, 1985).

g) The Present Status

By the end of 1984 over 5,000 latrines, and 200 wells had been constructed in the pilot projects, representing an increase in coverage of 75% for sanitation and 30% for improved water supplies. The pilot projects in Masvingo no

Figure 12.

Model Project Cycle as Refined by the Ministry of Health in the
Pilot Projects (from NMPRWSS, 1985).

Activity	Participants	Purpose
A. PREPROJECT		
1. Initial meeting and discussion with community leaders.	Project designer HIs community leaders	To discuss possible project and agree procedure for continuing To discuss needs & priorities. The community will have been identified by the provincial or district MOH staff.
2. Meeting of community and its leaders	Community & leaders. Project designer as observer	To inform of potential project & discuss needs & priorities and obtain broad agreement & continue preparation cycle
3. Baseline survey	Project staff HAs & VHWs. Community Community leaders	To obt'n demographic health environment socioeconomic & physical data for project design. To identify social & inst. structures
4. Technical consultancy	Consultants Ministry	To obtain geophysical & soils data if required
5. Meeting with district team	Project Manager Community leaders District team	To inform of project obtain concurrence identify other extension workers & resources that may be coopted into project
6. Project design & plan of operations	Project designer HIs Community leaders	To define inputs & outputs responsibilities site wells prepare implementation programme
7. Briefing/refresher training extension workers	Project trainers HAs Extension workers	To inform of strategy, plan of operations & bring up to date technically if required

Figure 12 continued.

Model Project Cycle as Refined by the Ministry of Health in the
Pilot Projects (from NMPEWSS, 1985).

Activity	Participants	Purpose
B. DURING PROJECT		
8. Build demo wells and latrines	Extension workers	To provide visual proof of well operating facility in order to aid mobilisation
9. Mobilisation meetings	Extension workers Community leaders Community	Mass or small group meetings used to discuss the benefits of the project
10. Form construction groups	Community	Groups of 10 house holds encouraged to construct communal wells and individual latrines. Group members identified for training. Collection of materials organised
11. Monitoring commences	Project staff	Monitoring of; groups formed, materials distributed, follow up visits etc
12. Training builders and user groups	Extension workers HAs	To improve skill level of individuals and builders in latrine and well construction
13. Commence building	Construction Groups Households	Excavation of wells and latrines complete and local materials collected in order to qualify for materials grant
14. Materials provided	Project staff	Cement and hand pumps provided to community
15. Follow up technical/advisory visits	Extension workers HAs Construction groups	To advise and assist in building. To install hand pump and to ensure completion
16. Follow up health/hygiene visits	Extension workers VHWs Households	To advise on maintenance and use of facilities, and provide health and hygiene education

Figure 12 continued.

Model Project Cycle as Refined by the Ministry of Health in the
Pilot Projects (from NMPRWSS, 1985).

Activity	Participants	Purpose
C. POST PROJECT		
17. Pump caretaker appointed	Community leaders Construction groups	To identify community member with prime responsibility for taking care of the hand pump
18. Evaluation	Project manager Community	To determine if project goals have been achieved and to provide data for new project designs
19. Long term follow up health/hygiene education	Extension workers VHWs Households	To ensure continued hygienic use of facilities, continued maintenance and to reinforce education messages
20. Long term follow up well & latrine maintenance	Extension Workers HAs Households	To ensure latrine is replaced when full and structural maintenance is carried out

longer exist as a separate entity, whereas the Mhondoro project continues in an expanded form (Boydell, 1985d).

10.2 Planning

a) Base Line Data and Feasibility Studies

A base line survey was carried out in 1981 by the MOH as a basis for future evaluation of the primary health care programme that was envisaged at that time. Coverage levels of water and sanitation were lower than the national average, only 10% of the population drew water from protected sources and 91% of the population defecated indiscriminately. Knowledge of the causes of disease and basic hygiene were also found to be very limited. Social or logistical feasibility studies were not carried out.

f) Project Planning

An initial plan was prepared for each project which set targets in terms of numbers of facilities to be constructed together with a list of inputs to be provided by the donor and the assumed contribution of the community, and in the case of Mhondoro a list of inputs to be provided by Government. However, it is difficult logically to relate the inputs to the targets. Also education and training elements of the project were not set out in detail, neither was thought given to the future maintenance of the hand pumps that were to be provided. The construction targets were: Mhondoro 40,000 latrines and 400 wells; Serima and Zimutu 2,000 latrines and 200 wells in each.

c) Community Participation in Planning

Community participation in planning was limited to community group level decisions making. The community was not involved in the project designs at district or ward level, except as represented by their councillors. The community inputs to the planning process in reality were a series of decisions including whether to participate or not; where to site a well; who should be members of the

water committee and how to organize their inputs of materials and labour (Skitt, 1986).

d) Choice of Technology

As in most other water sector projects in Zimbabwe, the choice of technology was not a subject of debate. Water supply was developed by digging shallow wells which were then fitted with Blair handpumps. In Mhondoro, the wells were lined with concrete rings manufactured centrally by MOH staff, whereas in Masvingo well lining was done by the community who used natural materials. Later in the project, hand augered tube wells fitted with bucket pumps were introduced in the Masvingo projects and became an alternative standard. Spiral Blair latrines constructed from burned bricks, thatched roofs and fitted with PVC ventilation pipes were specified as standard in Mhondoro. In Serima and Zimutu a square design with a brick ventilation chimney and concrete slab roof was adopted (Morgan, 1985/87).

10.3 Implementation

a) Donor, Community and Government Inputs

The contributions provided by the donors to the projects were;

The EEC provided: the Mhondoro project with a grant of Z\$150,000 for cement to construct 4,000 latrines and 400 wells, hand pumps, reinforcement steel, PVC ventilation pipes, 20 tool kits for builders, and two vehicles (Skitt, 1986).

War on Want provided: the Serima project with a grant of Z\$105,000 for materials in a similar arrangement as above in order to construct 2,000 latrines and 200 wells. No appropriate donor was found for Zimutu and capital costs were funded from the MOH's "Disease Prevention Field Vote". An allocation to MOH from central Government to fund field activities such as mosquito spraying. In Financial Year (FY) 82/83 the field vote for Masvingo was some

Z\$200,000 of which 50% was spent on RWSS. In FY83/84 and 84/85, a further Z\$50,000 was added to the regular vote to support the Zimutu project (MOH, 1984/87. Boydell, 1985d). Other contributions were provided by:

The Government who provided: the catalyst for all the project, funding for addition equipment and operational and overhead costs, staff for management supervision training and extension, liaison with donors and other institutions, hygiene and health education follow up.

The community who provided; locally available materials for the construction of the wells and latrines, sand, stone, thatching grass and labour for transporting the materials and construction, and in a number of cases, cash to employ a builder to construct their latrine.

b) Institutional Relationships and Managerial Arrangements

The pilot projects were designed in the Health Inspectorate in the MOH headquarters. They were managed by the MOH's Provincial Health Inspectors based in the provincial capitals. They oversaw the day-to-day activities of the district health inspectors and the health assistants based in the project areas. The HAS managed the project at field level and provided technical assistance to the community, they arranged the training of builders and the distribution of cement and other materials. The HAS also supervised and coordinated the activities of the VHWS, who assisted in mobilizing the community and in follow up health and hygiene education visits. The district administrator and his staff of LGPOs were also involved in the project particularly in promotional activities, in the choice of areas in which the project should concentrate activities, and the ranking of priorities. Staff from the Blair Laboratory provided training courses for HAS on the building of latrines and wells, pump maintenance, and the use of the hand auger (MEWRD, 1985. MOH, 1984/7).

c) Communications

Communications within the project can be considered in four categories: informing and mobilizing the community; training of HAs and local builders; supervision and technical assistance; and health education follow up visits. Initially the communities were informed about the project during mass political rallies. In fact, national level politicians and ministers amassed great political capital from promises of water and sanitation for all. However, the actual mobilization of the community to provide inputs of labour and materials was done by local councillors and the LGPOs, assisted by HAs and VHWs. Training was carried out at two levels. The Blair Laboratory undertook to provide technical training of the HAs, who in turn, ran training courses for local latrine and well builders. The HAs also provided day to day advice to builders and families on well siting and construction issues (Morgan, 1985/87). The VHWs played an important role throughout this process but particularly in following up the construction of latrines and wells with health and hygiene educational support.

d) Credit and Finance

The projects were funded from grants given by the EEC (Z\$230,000 for Mhondoro), War on Want (Z\$105,000 for Serima) and domestic allocations through the MOH (Z\$150,000 capital costs for Zimutu). MOH also provided the recurrent and overhead costs for all the projects. Cost recovery or provision of credit were not features of the projects. However, the community was expected to make a substantial contribution in both cash and labour. In the Mhondoro project, where emphasis was placed on training builders, a family would be required to collect materials and pay a builder between Z\$25 and Z\$40 for constructing a latrine, and a further Z\$5 to Z\$10 for the construction of a communal well. The proportion of the total costs for latrines and wells, to be paid by the donor, Government and the community, was calculated in cash equivalents as

follows. For wells the donor contribution was Z\$90 or 53%; Government Z\$20 or 12%; the community Z\$60 or 35%. For a Blair latrine the donor contribution was approximately Z\$30 or 27%; Government Z\$20 or 18%; the community Z\$60 or 55% (Boydell, 1985d. Skitt, 1986.).

10.4 Findings and Results

a) Achievements of Goals and Objectives

All the projects were slow in gaining momentum and did not achieve the targets envisaged in the original project design. By mid 1985 approximately half of the latrines targeted had been constructed and at best, a quarter of the wells. The improvement in health was not measured or assessed. It is therefore, difficult to assess the achievement of the higher goals. However, it is clear that the pilot projects had a major impact in shaping future sector policy in Zimbabwe.

b) Acceptance and Use of Technology

Evaluations of the pilot projects were carried out using the WHO Minimum Evaluation Procedure (Boydell, 1984a. Skitt, 1986). The following was found. For all the installations of latrines and water points the major problem was reaching final completion. 40% of latrines were without roofs or ventilation pipes although, almost all were being used. Similarly 33% of wells were incomplete - cover slabs, pumps or aprons had not been fitted. Of the completed facilities 65% were being fully used, well maintained, and were operating without odour or fly breeding. The community felt that the latrine component of the project would be improved by providing more cement and paint. Of the wells, 60% were being operated successfully. Of the remainder, the users found the supplies unreliable or insufficient. The community suggested that the projects would be improved by providing a cattle trough and follow up visits to repair imperfections in the construction. Other significant community reactions to the projects were

that 30% felt that additional wells were not required, 25% could not form a construction group or committee and 16% could not obtain suitable materials as required by the project.

c) Maintenance, Cost Recovery and Replicability

Cost recovery was not attempted in any form and any future replication of the projects would require major subsidies from Government or donor grants. However, replication of the strategy developed in the pilot projects had already commenced in other provinces led by the MOH Provincial Health Inspectors. This is discussed below in section 10.5 "The MOH National Rural Water Supply & Sanitation Programme". A major factor in the potential replicability of this project model would be the difficulty in using shallow wells in areas where the ground water is at considerable depth, other water development techniques would be required. Maintenance of the hand pumps provided under the project was carried out on an ad hoc basis by the HAS assigned to the project areas. Limited success was achieved in establishing well committees and community pump minders (Narozny, 1985).

d) Institution Building and Effects on Policy

Clearly the main success of the pilot projects was their impact in building the capacity of Government, particularly MOH and the local administration, to implement community based sector projects. The projects also had a profound effect on shaping sector policy, particularly in the integration of water sanitation and education components within projects. The strategy evolved in the pilot projects has been adopted by Government as a sound approach to developing the sector (MEWRD-NMPRWSS, 1985). The only substantial criticism of the strategy was the lack of a cost recovery element.

e) Project Designs

An inspection of the original project documentation

indicates that the original project designers had given little thought to equating the desired project outputs to the proposed inputs. For example, in the Mhondoro project it was expected that the project would minimize disease through the construction of 4,000 latrines and 400 wells which would at best serve 50% of the population. This may be forgiven as initially the programme was conceived to be part of an integrated primary health project. However, individual project components seem less than adequate. For example, the training of only 20 builders would seem insufficient to undertake the envisaged scope of work and the lack of a planned maintenance strategy for the hand pumps indicated a short term view of the project. A further design error was the under-estimation of the considerable lead time needed to establish a community based project such as these (Skitt, 1986).

f) Other Factors

One of the main factors in the successes of the pilot projects was the dedication of the two leaders or project managers. In Masvingo the Provincial Health Inspector, David Proudfoot, drove the Serima and Zimutu projects to successful conclusions. Similarly, District Health Inspector, Garth Parsons, was the driving force behind the Mhondoro project. A second remarkable factor in the projects was the relative success of the latrine building, as opposed to well sinking, which is contradictory to experience in other countries where the provision of water is much more acceptable than sanitation. This was due to the Blair Latrine which was seen as Zimbabwe's own special product, to which the MOH had a special affinity, which led to the latrines institutionalization. More simplistically, latrines are easier to construct than wells. A similar affinity for the Blair Pump existed even though its performance and reliability was questionable (Boydell, 1984a).

10.5 The Ministry of Health Expanded Rural Water Supply and Sanitation Programme

Inspired (or piqued) by the early success and high visibility of the pilot projects in Masvingo and Mashonaland West Provinces, Provincial Health Inspectors in other provinces initiated strong drives to accelerate the provision of rural water supplies in their own areas using the strategy developed in the pilot areas. The expanded programme was mainly internally funded from the Disease Prevention Field Vote, supplemented by grants from a variety of donors, mainly NGOs. In Matabeleland North and South Provinces, Oxfam (UK) and UNICEF provided support to the provincial programme. VOICE a local NGO, and Freedom from Hunger were strong supporters of the programme in Midlands, Manicaland and the Mashonaland Provinces (FFH, 1984/87. Boydell, 1985c). This expanded programme became a de facto national programme for RWSS which by 1985, only five years after Independence, was fully active in all eight provinces of Zimbabwe. Table 16 indicates numbers of latrines and wells constructed in the expanded programme. In comparison table 17 shows the levels of investment from the field vote and grants. One of the reasons for the remarkable acceleration of RWSS programme was the overall dedication of the MOH's Health Inspectorate who, after Independence, were somewhat adrift and looking for some activity with which to identify. A second reason was the remarkable demonstration effect of the initial three pilot projects.

10.6 Lessons to be Learned from the Project

The summary of a systems analysis of the projects is given in table 18 and shown diagrammatically in figure 13. One of the most valuable lessons that can be learned from the MOH Pilot Project and the subsequent expanded programme is that Government, albeit prompted by political pressure, could adopt a community based RWSS project delivery

Table 16.

Number of Protected Wells & VIP Latrines Constructed by
Ministry of Health from January 1982 to December 1985
(from NMPRWSS, 1985).

Province	Number* VIP Latrines	Number+ Protected Wells
Mashonaland East	3129	1695
Mashonaland Central	1926	995
Mashonaland West	8637	1070
Matabeleland North & South	4852	808
Midlands	4167	833
Masvingo	15297	3319
Manicaland	3887	1678
Total	41895	10398

* Does not include numerous non vented latrines still being constructed

+ Does not include lined wells fitted with a windlass and bucket

Table 17.

Expenditure by Ministry of Health on Water and Sanitation Between 1982 and 1984 (from NMPRWSS, 1985).

Province	1982 to 1983			Add'nal Donor funds Z\$'000
	Field Vote Allocated	Z\$'000 Expended	% used for water & san	
Manicaland	250	157	5	30
Nasvingo	199	195	80	31
Midlands	130	108	10	90
Mashonaland E				0
Mashonaland E	140	141	20	0
Mashonaland E				22
Matabeleland N	220	188	50	0
Matabeleland N				0
Totals	936	798	=250	173
Total expended by MOH in 82/83 on water & sanitation Z\$423 000				

Province	1983 to 1984			Add'nal Donor funds Z\$'000
	Field Vote Allocated	Z\$'000 Expended	% used for water & san	
Manicaland	124	386	5	93
Nasvingo	137	375	80	70
Midlands	111	131	10	10
Mashonaland E	80	206	15	0
Mashonaland E	80	67	20	6
Mashonaland E	80	96	10	35
Matabeleland N	170	146	25	12
Matabeleland N	150	28	15	12
Totals	1056	1425	=400	238
Total expended by MOH in 83/84 on water & sanitation Z\$638 000				

NB; For 1984/85 a further Z\$1.8M was allocated as Field Vote of which approximately 20% was used for water and sanitation, this together with additional donor grants increased MOHs expenditure in the sector to some Z\$750 000.

strategy developed by NGOs, and demonstrate its effectiveness. Having gained this endorsement the strategy was widely replicated and thereby water and sanitation activities were expanded throughout the country. In the expanded programme additional external donors were attracted to the sector following as a specific result of this endorsement. It is also clear that the availability of flexible and unconstrained project support from external donors is critical in the development of new and innovative approaches to the provision of basic services, for example, the EEC Micro Project Fund which was critical to the success of the Mhondoro Project. Local level political support and the endorsement of mass participation in projects by local leaders was also seen to be important. However, the dropping of cost recovery as an component of the project strategy adopted from the NGOs because of political concerns was a significant trade off. As in both St. Theresa's and the CSSD projects a key component of the project delivery strategy was to remove constraints to self help construction by providing essential materials unavailable to the community. Other lessons are charismatic leadership, standardized and institutionalized technologies, that is, the Blair latrine and pump and the positive role that the private sector can play in sector development, for example, the use of local builders for latrine and well construction. Negative lessons are inefficiencies of the rigid a Government bureaucracy in implementing community participation projects.

Table 18Summary of Systems Analysis of the MOH Pilot Projects1. Systems Present and Their Function

Donors who supported the project; a community who participated and were beneficiaries; and Government who executed the project.

2. Actors and Their Roles

Donor: The multilateral - EEC, and the NGO - War on Want who supported the project.

Community: political representatives; traditional leaders and small community groups with whom agreements were made; water/health committees who then operated the latrines and wells; and local builders who constructed the wells and latrines.

Government: MOH who executed the project; the Blair Laboratory; health inspectors and health assistants who supervised field activities; and village health workers who provided education and promotion.

3. Leaders and Accountability

Donor: Programme officers who were accountable to the donor headquarters.

Community: Traditional and elected leaders who had limited accountability to the community.

Government: The provincial health inspectors who were accountable to their ministerial headquarters.

4. Perceptions and Self Interest

Donor: That the provision of water and sanitation in rural areas was a major problem and that the donor could support the Government in its provision through a community participation approach.

Community: To maximize the aid provided by the donor in order to improve their environment and living conditions.

Government: To maximize the aid from the donors; to develop models for the provision of water and sanitation through community involvement as part of primary health care.

5. Goals and Criteria of Achievement

Donor: number of latrines and wells constructed; funds not misused.

Community: continuous water supplies and provision of latrines.

Government: number of latrines and wells constructed; and visible activities of improving water and sanitation facilities in the communal areas.

Table 18 Continued6. Problem Definition and Solution

Donor: by the programme officers.

Community: problems and solutions were not defined internally, however small community groups were assisted in vocalizing their water needs by Government field workers.

Government: by the provincial health inspectors.

7. System Interaction and Boundary Spanning

There was little interaction between the donor and Government systems other than progress reporting. However, the interaction between the Government and the community system was substantial the contacts being through the Government field workers who met with politicians and small community groups.

8. Commonality and Conflict

The commonality in all the systems was an appreciation of a need for improved water supplies. However, conflict arose between the Government and community systems as it was perceived by the community that the Government was inefficient in executing the project and fulfilling the promises of the political leaders.

Other Evaluation Criteria

9. Project objectives clearly defined?.....Partially.
10. Sufficient resources allocated?.....Partially.
11. Any baseline or feasibility studies?.....Yes.
12. Links established to other sectors?.....Yes - health.
13. Productive capacity improved?.....No.
14. Role of technical assistance and NGOs?.....None.
15. Role of Women?.....Not emphasized.
16. Role of private sector?.....Local builders constructed the wells and latrines.
17. Appropriate technology used?.....Yes.
18. Health/Hygiene education provided?.....Yes.
19. Any costs recovered?.....No.
20. Any monitoring and evaluation?.....Partially.
21. O & M provided for?.....No.
22. Identifiable project phases?.....Yes - pilot activities and expansion.
23. Any role on effects?.....Yes - the project had impact on subsequent MOH programmes.
24. Water sanitation and education integrated? Yes.

Figure 13. Systems Diagram of the MOH Pilot Projects.

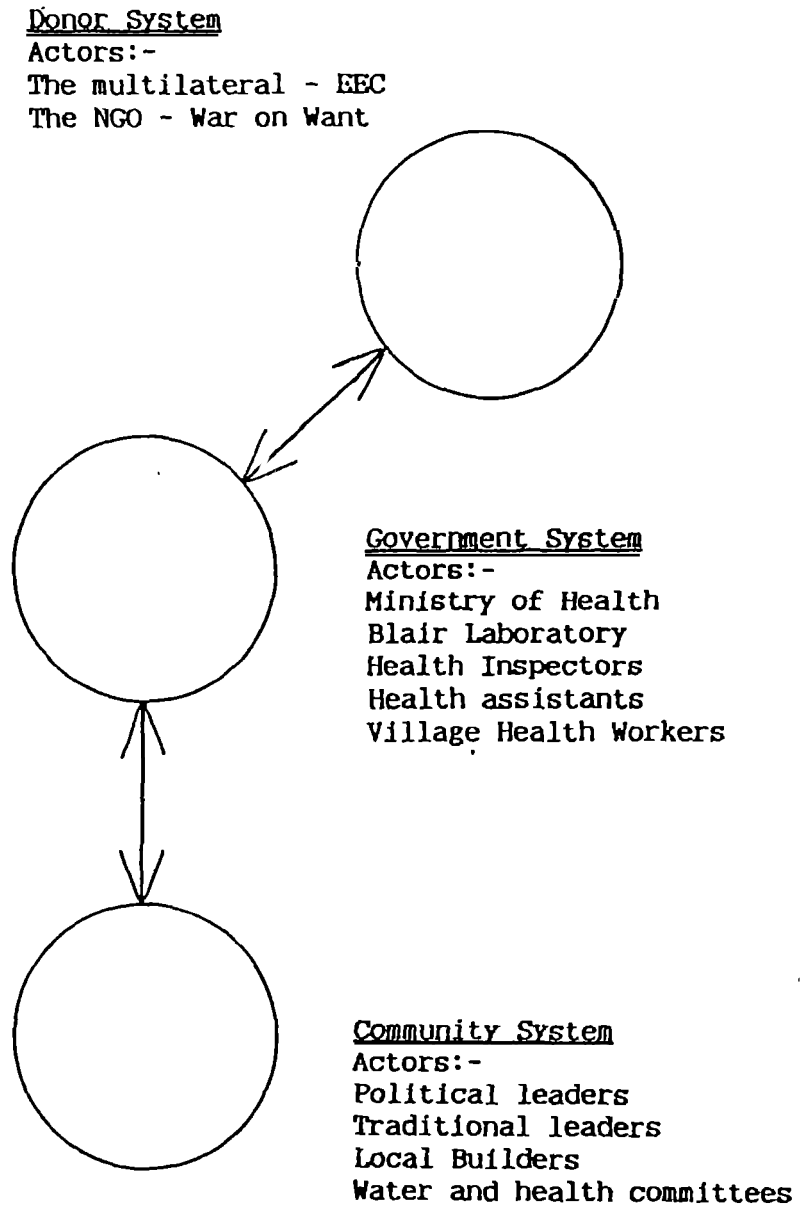



- o 0 o -

Chapter 11

The GTZ Villages Rural Water Supply and Sanitation
Programme in Masvingo Province
and the
Coordinated Agriculture and Rural Development Programme
in Gutu District

- o 0 o -



Chapter 11

The GTZ Villages Rural Water Supply and Sanitation Programme in Masvingo Province and the Coordinated Agriculture and Rural Development Programme in Gutu District

11.1 Background

a) General Description

In 1982 the Government negotiated with the West German aid agency GTZ to support a broad integrated rural development programme in Masvingo Province. It was agreed that GTZ would provide general development support to the province through the strengthening of the provincial capacity of the Agricultural and Rural Development Authority (ARDA) by establishing a Project Preparation Unit (PPU) in the provincial HQ. The PPU would assist in stimulating development coordination and pinpoint any constraints to the development process. The donor would then provide technical assistance and funding for designing and implementing projects to overcome these constraints.

A provincial level inter ministerial committee was formed to prepare priority development projects and to identify constraints to their implementation. This led to a series of inter linked micro projects being quickly launched and the commissioning of a number of parallel studies. The micro projects included (MEWRD-NPWRWSS, 1985): Small scale enterprise promotion; construction of small earth dams and weirs; cooperative vegetable gardens and small scale irrigation; village water supply and sanitation; and establishing wood lots. The studies which were mainly carried out by a group of West German expatriates based in ARDA, known as the German Agricultural and Development Team (GART), included: Rural afforestation; land use reform; emergency drought relief planning; and the

design of a model district level coordinated agriculture and rural development programme (CARD), in Gutu District (GTZ, 1984/87).

The provincial administration of the MOH were charged with the responsibility of designing and implementing the "Village Water Supply and Sanitation Micro Project" for which they received a grant of Z\$140,000. The strategy for the programme was based on the experiences gained in the Serima and Zimutu pilot projects. In effect the pilot projects were expanded into a province wide activity. In addition to this, during 1984, the GART team produced a proposal for a "Commodity Grant Drought Relief Project" which provided commodity grants for communities in distress because of the drought. This included materials for the construction of some 1,500 latrines and 350 wells, together with hand pumps, two small trucks, and eight tube well hand augers (GART, 1985). Thus by 1984, MOH in Masvingo had gained access to substantial resources for water and sanitation which, following the momentum started in the pilot projects, greatly accelerated the implementation rates of the RWSS programme in the Province. In parallel to this the GART team were undertaking the various studies listed above and preparing the design of the model integrated rural development project to be tested in Gutu District (Stilz & Weyl, 1986). Based on the experiences of the pilot projects and the expanded programme, the model project had a strong water and sanitation component. The integrated rural development programme that was evolved provided a good vehicle for water and sanitation development.

b) The Donor

GTZ is the executing agency for technical assistance in the West German bilateral aid programme. It is active in many countries in east and southern Africa particularly in the agriculture, water supply and training sectors. GTZ have championed the integrated rural development approach and examples of successful programmes can be seen in nearby

Zambia, Tanzania and Mozambique. GTZ's philosophy includes working at the lowest effective operational level of government in order to build capacity and enhance skills, and to apply a rigorous, logical and systematic approach to programme design and planning (GTZ, 1984/87).

c) Objectives and Target Groups

The objective of the programme was stated to be the stimulation of rural development through a systematic approach which coordinated institutional efforts, sectoral needs, and peasant requirements without endangering the fine ecological balance common in areas with marked seasonality. The target group was identified as the peasant farmers of the communal areas. Women were singled out as being in need of special support for income generating activities and as targets for promotional and educational activities.

d) Integration of Water, Sanitation, Health and other Sectors

Within the programme, a basic needs approach was used. Water and sanitation were seen as the main elements of the health needs which together with agricultural, energy, security and income needs made up the programme package. The various programme components are detailed in table 13.

e) The Extension Strategy

Although the individual components of the programme were designed to redress the various underlying causes of rural poverty, the programme also tried to meet the non material needs of the farmers by involving them in the development process and ultimately strengthening their self reliance. The project also aimed to strengthen the district and provincial administrations by involving them in the planning and coordination of activities. Individual line or sector ministries were responsible for implementing the various programme components. Table 19 lists the non material components of the programme and the implementing

agency. The main features of the implementation strategy can be summarized as: To execute a series of coordinated interventions aimed at removing the underlying constraints to agricultural and rural development. To emphasize agricultural development as the cornerstone of rural development. To integrate and coordinate the various sectoral inputs. To use teams for the planning and implementation of the programme who would concentrate on developing a logical plan that would benefit the majority of producers in the communal areas.

f) The Present Status

By the end of 1985 some 7,000 latrines and 400 water points had been constructed in the province, and funding for a further 7,000 latrines and water points had been requested from GTZ. Table 20 details the number of latrines constructed by district in the period 1983 to 1985. The Gutu Project continues (MEWRD, 1985. Boydell, 1985a).

11.2 The Planning Phase

a) Project Planning

Base line data was collected in a number of studies as listed above. This formed the basis for the planning of the various components of the programme. For the Village Water supply and Sanitation Project (as in the other components) the "logical framework" planning technique was used to evolve a plan of operation and an implementation strategy that attempted to equate proposed inputs to planned outputs. Annex 3 describes the logical framework planning technique and provides, as an example, a "log-frame" developed for a rural water supply and sanitation project.

b) Community Participation in Planning

As in the pilot projects, community participation in conceptual planning was not a feature of the programme. The community inputs to the planning process was limited to decisions regarding the organization of their contributions

Table 19.

Basic Needs as Perceived in the Masvingo Coordinated Rural Development Programme (from Stilz & Weyl, 1986).

Material Needs	Programme Component	Non-material Need Component
Subsistence level needs	Crop development Livestock development Horticultural development	Group formation Consensual decision making Target group participation
Energy needs	Agro-forestry development Improved farm practices	Self-reliance increased
Health needs	Water and sanitation	Self-management of groups and societies
Material security	Increased cash income from agricultural production	Autonomous decision making Limited external influence Identity; thro traditions
Ecological needs	Land-use development	
Employment	Off-farm development	Creativity Diversity

Table 20.

Number of Latrines Constructed in Masvingo Province Between 1983 and 1985 by District (from Boydell, 1985a).

District	1983	1984	1985	Programme targets
Mwenezi	96	125	398	600
Bikita	364	611	561	7000
Chiredzi	347	492	263	1100
Gutu	2160	715	465	1900
Masvingo	2021	2544	793	400
Chibi	689	587	560	1500
Zaka	124	622	487	0

to the programme, for example, how to manage the collections of local materials.

c) Choice of Technology

The basic choice of water supply and sanitation technology remained the same as in the pilot projects. However, the range of water supply technologies was expanded. In the spirit of inter ministerial coordination, the provincial office of MEWRD also assisted the programme through the provision of deep blasted wells and mechanically drilled boreholes in the area to supplement the shallow water supplies being developed by the MOH. These deeper sources which were provided in an approximate five kilometer grid pattern over the area were less sensitive to drought, and were thought to be a "fall-back or reserve" for when other shallow supplies failed (Stewart Scott & Partners, 1984).

11.3 Implementation Phase

a) Donor, Community and Government Inputs

In the village water supply and sanitation project and the Gutu model rural development programme, the contributions of the three participating groups to the provision of water supplies and sanitation remained basically the same as in the pilot projects. However, as a result of the logical planning exercise, emphasis was placed on developing better communications with the farmers. This involved providing better training materials and making the extension workers more mobile by providing them with bicycles.

b) Institutional Relationships and Managerial Arrangements

The provincial level coordination of an inter ministerial group, each member being responsible for one component of the activities, continued as the basis for the management of the programme. Coordination was led by ARDA supported by the GTZ technical assistance team. The World

Bank/UNDP TAG group assisted the MOH in the design of the water and sanitation component which was executed by the MOH through its provincial health inspectorate (GTZ, 1984/87. MOH, 1984/87).

c) Communications

Communications within the water and sanitation component of the programme remained essentially the same as in the pilot projects. However, special emphasis was given in the development of training materials to support the construction and use of facilities. A series of good quality training modules (trainers manuals, builders manuals and reminder cards, user reminder cards and promotional posters et cetera) were developed including maintenance information on the handpumps used in the programme (Laver, 1985).

d) Credit and Finance

Credit was not provided to farmers within the programme neither was any attempt made at cost recovery. The equivalent cash contributions of the donor, community and Government to the construction of wells and latrines remained the same as in the pilot project. In addition to the funds provided to the pilot projects and domestic funds from MOH's Field Vote, GTZ provided an additional Z\$140,000 for the village water supply and sanitation programme, and the equivalent of Z\$150,000 in commodity grants for sector development. In mid 1985 a new funding proposal was prepared requesting some Z\$350,000 to extend the programme for a further two years (GART, 1985. Boydell, 1986a).

11.4 Findings and Results

a) Achievement of Goals & Objectives

It is evident that the expanded water supply and sanitation programme in Masvingo achieved its objective of substantially increasing the coverage levels of water and sanitation facilities in the communal areas (see table 16).

The programme also provided a good model for "integrated" local level planning and coordination that was responsive to the basic needs of people.

b) The Impact of the Programme on Women

Peasant women make up 55% or so of Zimbabwe's rural work force (Stilz & Weyl, 1986). Socially inferior to men, they are overworked, ill equipped financially and educationally, but despite this, much of rural production is left in their hands. In 1986 GTZ undertook a limited evaluation of the Masvingo programme's impact on women. The evaluation, which was unique for water projects implemented in Zimbabwe at that time, focussed on three areas of assessment; firstly, the actual and potential impact on women's income, workload, status in society, and access to education and extension services; secondly, the methodology and resources used in the programme to improve the status of women; and thirdly, any constraints to the project having a positive impact on women (Raabe, 1986). Of all the components in the programme, water supply and sanitation was singled out as having the most noticeable effect on women through the improvement of health, the reduction of the water carrying burden and the facilitating of income generating activities, such as vegetable growing.

c) Acceptance and Use of Technology

Acceptance and use of technology remained basically the same as in the pilot projects. However, two improvements were made; firstly, the broadening of the range of water supply technology to include deep wells and boreholes, which provided a greater degree of security of service, and secondly, the better training materials, and improved standards of communications and training greatly improved the construction of latrines and wells and their hygienic use (Boydell, 1984a).

d) Maintenance, Cost Recovery and Replicability

The provision of credit or recovery of costs was not

considered to be an issue in either the pilot projects or expanded programme, the assumption being that subsidies would continue to be available from Government or a donor. The expansion of the programme to include the more robust water supply techniques of deep wells and boreholes certainly improved potential replicability in areas where ground water was at a greater depth. It also increased the need for a more formal and structured maintenance system for the hand pumps provided under the programme. However, handpump maintenance continued to be carried out on an ad hoc basis by the HAs with more emphasis being placed on establishing water committees at community level and training of the HAs and pump minders using the training materials that had been developed, rather than on establishing a formalized maintenance structure (Narozny, 1984).

e) Institution Building and Effects on Policy

The rapid development of the water and sanitation sector in Masvingo had a major impact in the shaping of programmes in other provinces particularly those implemented by the MOH. The programme also contributed significantly to the building of institutional capacity at provincial level particularly in project planning and coordination. However, the apparent disadvantage of a provincially based and managed programme was its lack of high profile or visibility at national level. Hence, the apparently successful model integrated rural development project (of which water and sanitation were major components), was not fully adopted by Central Government as basis for a national policy. Similarly the NMPRWSS although adopting the MOH's sector implementation strategy did not discuss in substance, provincial or district level planning as a foundation for a basic needs approach.

f) Project Design

The use of the "logical framework" planning techniques as a planning tool by an inter-ministerial group at

provincial level ensured that the programme design related the expected outputs or objectives to the proposed inputs within the context of a realistic time frame. Although far from perfect, the programme design was perhaps one of the better examples in the sector in Zimbabwe. Omissions from the design were consideration of the needs for maintaining hand pumps, cost recovery, and dissemination of activities.

g) Other Factors

A major factor in the success of the programme was leadership. The Provincial Health Inspector David Proudfoot led the water and sanitation component from the pilot phase to a province wide programme. In parallel, Dr Ulrich Weyl, the senior GTZ advisor, supported ARDA in developing the concept of the integrated approach to rural development and facilitated the coordination and implementation of activities. Also, the programme gained strong political support at provincial level and was seen by the local politicians as something of a banner to be waved at rallies and meetings in order to increase political capital.

11.5 Lessons to be Learned from the Project

The summary of a systems analysis of the projects is given in table 21, and depicted in figure 14. Two valuable lessons can be learned from the GTZ Villages RWSS Programme and the Gutu Coordinated Agriculture and Rural Development Programme. First, that rapid expansion of a RWSS service provision can take place from the foundation of a good demonstration project, in the Zimbabwe case the foundation was the MOH Pilot projects. Second, the benefits to be gained in integrating RWSS into an agriculture and rural development programme. Water and sanitation were seen as a viable entry point for broader developmental activities. Other lessons are the ability of a bilateral donor to provide flexible support to a programme focussed on the removal of critical constraints at provincial and district level; the strengthening of local governments capacity to

plan and implement their own programmes; the benefits of logical and local level programme planning and the strength of an area based approach. As in the other projects reviewed the importance of women as targets in extension activities, charismatic leadership and the use of institutionalized technologies were clearly seen. Key component of the project delivery strategy were the removal of constraints to development and the involvement of the small scale private sector.

Table 21.Summary of Systems Analysis of the GTZ Programme1. Systems Present and Their Function

A donor who supported the project; a community who participated and were beneficiaries; and Government who executed the project.

2. Actors and Their Roles

Donor: The bilateral - GTZ who supported the project; and the expatriate advisory team who supported the design and management of the programme.

Community: political representatives; traditional leaders and small community clusters which were the social unit with which agreements were made; and water/health committees who then operated the well; local builders who constructed the wells and latrines; and womens employment groups.

Government: ARDA, MOH and MEWRD who executed the project; provincial planning team who designed the project; health inspectors and health assistants who supervised field activities; and village health workers who provided education and promotion.

3. Leaders and Accountability

Donor: The expatriate team leader and project manager who was accountable to the donor headquarters and the Provincial Government.

Community: Traditional and elected leaders who had limited accountability to the community.

Government: the provincial water engineer and provincial health inspector who were accountable to their ministerial headquarters.

4. Perceptions and Self Interest

Donor: That water scarcity was a major problem and that the donor could support the Government in its provision as part of an integrated rural development approach. That working with and through Provincial Government with community groups using appropriate technology was an effective strategy in doing this.

Community: To maximize the aid provided by the donor in order to improve their environment and living conditions.

Government: To maximize the aid from the donor in order to be seen in solving the drought problems of Masvingo; and that water and sanitation are important components of primary health care.

5. Goals and Criteria of Achievement

Donor: number of latrines and wells constructed and functioning; agricultural and other production increased.

Community: continuous water supplies particularly for cattle.

Government: number of latrines, boreholes and wells constructed; and visible activities of drought relief in Masvingo.

Table 21 Continued6. Problem Definition and Solution

Donor: by the expatriate team with Provincial Government.

Community: problems and solutions were not defined internally, however small community groups were assisted in vocalizing their water needs by Government field workers.

Government: by the provincial planning team including the provincial water engineer and provincial health inspector.

7. System Interaction and Boundary Spanning

There was substantial interaction between the donor and Government systems as the donor expert team was placed as an adjunct to the provincial Government structure. The interaction between the Government and the community system was also substantial the contacts being through the Government field workers who met with politicians and small community groups.

8. Commonality and Conflict

The commonality in all the systems was an appreciation of a need for improved water supplies. However, conflict arose within the Government system as it was perceived that the donor by operating at provincial level was bypassing the executive role of the central Government ministries.

Other Evaluation Criteria

9. Project objectives clearly defined?.....Yes.
10. Sufficient resources allocated?.....Yes.
11. Any baseline or feasibility studies?.....Yes.
12. Links established to other sectors?.....Yes - health and agriculture.
13. Productive capacity improved?.....Potentially yes.
14. Role of technical assistance and NGOs?.....TA played a major role in the project.
15. Role of Women?.....Emphasized as targets for promotion and income generating activities.
16. Role of private sector?.....Local builders constructed the wells and latrines.
17. Appropriate technology used?.....Yes.
18. Health/Hygiene education provided?.....Yes.
19. Any costs recovered?.....No.
20. Any monitoring and evaluation?.....Yes.
21. O & M provided for?.....Partially.
22. Identifiable project phases?.....Yes - institution strengthening and expansion.
23. Any role on effects?.....Yes - the project had impact on subsequent ARDA programme designs.
24. Water sanitation and education integrated? Yes - in a broad sense with rural development.

Figure 14. Systems Diagram of the GTZ Programme.

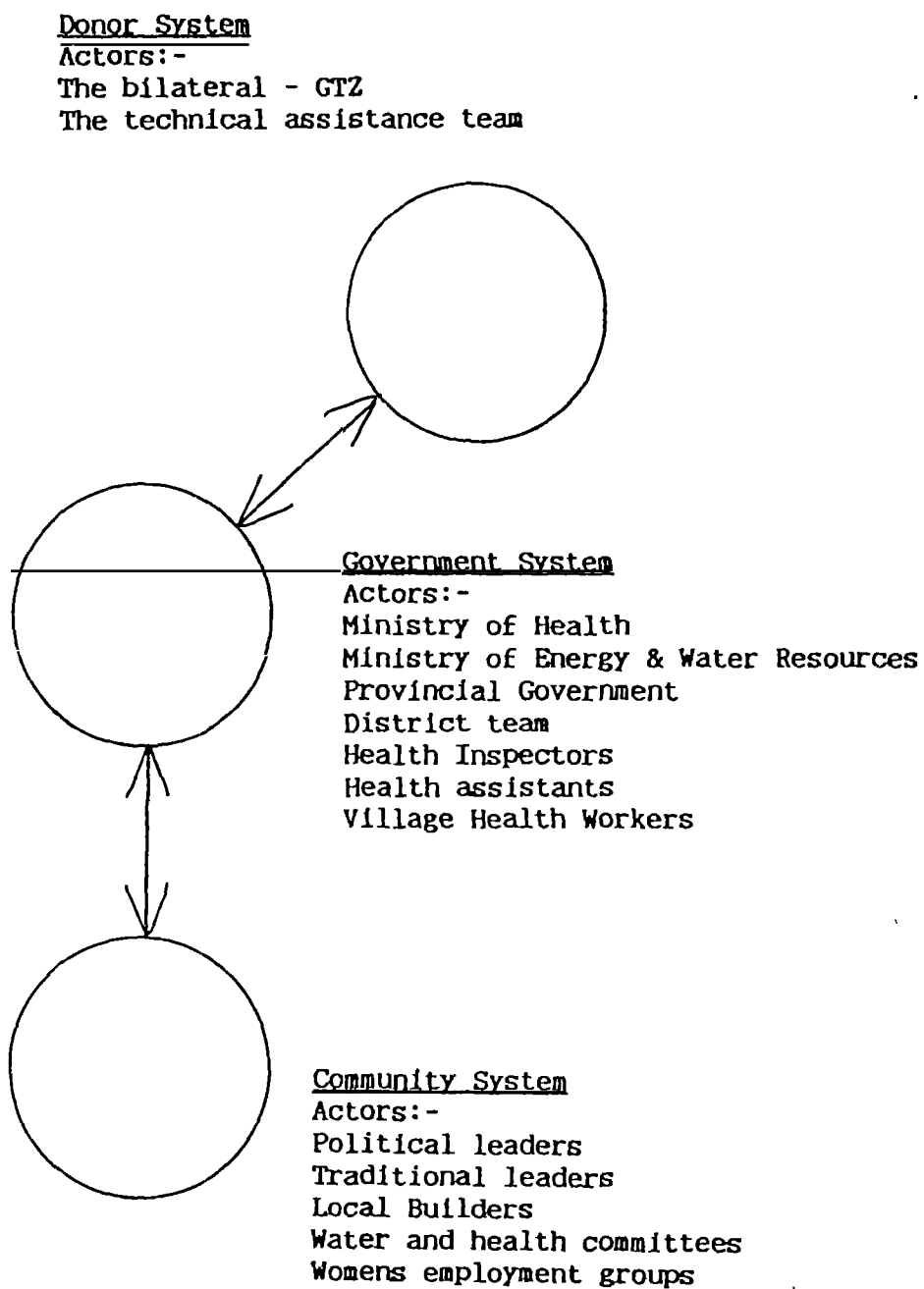

- o 0 o -

Chapter 12

The United Nations Childrens Fund
Assisted Wells Programme
in
the Matabeleland Provinces

- o 0 o -



Chapter 12The United Nations Childrens Fund Wells Programmein the Matabeleland Provinces12.1 Backgrounda) General Description

The United Nations Childrens Fund (UNICEF) provided support to the Government water wells construction programme in Matabeleland Provinces of Southern Zimbabwe that was originally formulated to relieve the drought situation of 1982. Water supplies were developed mainly for domestic consumption but a significant portion was used for cattle watering and small scale agriculture purposes. The programme which was executed by the District Development Fund, in collaboration with other Government bodies, has developed a technique for, and facilitated the construction of, wide diameter wells averaging over 20 metres deep. Wells were sunk through solid rock formations necessitating the use of explosives during construction. A second facet of the project was institution building and training. Community participation was also a feature of the activity; local communities made significant contributions to the construction of the wells (UNICEF, 1983. MEWRD-NWPRWSS, 1985).

b) The Donor

UNICEF is a well known multilateral agency, being the member of the United Nations family of agencies that deals with the welfare of children and mothers. It attracts funds from a variety of sources including charitable donations and monies channelled from other donors, mainly bilateral. During the 1970's and early 1980's UNICEF's policy on the scope of programmes which it could support, given its prime objective of child welfare, was interpreted in a broad

sense to include RWSS projects. Subsequently support to developing countries in the provision of water and sanitation became a major component of UNICEF's global programme. However by 1985, despite the UN Water Decade, UNICEF's management narrowed the agencies focus to more direct health interventions, the GOBI (Growth charts, Oral rehydration, Breast feeding, and Immunization) policy, and as a result support to water activities declined.

UNICEF's structure in Zimbabwe consisted of a country office or mission which reported to headquarters in New York through a regional office in Nairobi. Assistance in the water sector was provided to Government in the form of technical assistance, an expert on well sinking who was seconded to the District Development Fund, and other support in the form of equipment and cash grants. UNICEF firmly maintained a policy of working through Government structures and sharing in costs and other project support needs.

c) The Development of the programme

In 1980 UNICEF together with Government prepared a plan of cooperation, a component of which was technical assistance and materials support for restoration of boreholes damaged in the war and the drilling of new facilities. It was agreed that the programme should concentrate in the more arid areas of Matabeleland. Therefore, the expert was posted in Bulawayo provincial office of the MEWRD in 1981. In early 1981 a review of rural water supplies in Zimbabwe indicated the potential of deep wells as a method of providing water, the technique used by the former Department of Irrigation during the 1950's (Vogel *et al*, 1981). This was confirmed by recent successful well sinking operations that were being undertaken by the Lutheran World Federation. This is described in chapter 13. UNICEF then prepared a revised proposal for a well sinking programme to be "cost shared" with Government. This was approved in 1982. The proposal envisaged a pilot phase during which 40 wells were to be

constructed in ten districts over a period of three months, DDF being the executing agency with the UNICEF expert being the project coordinator (Williams, 1982). In November 1982 the project was launched at a workshop attended by councillors, DDF Field Officers, Local Government Promotion Officers and other personnel from the programmed districts. Domestic costs sharing funds for the pilot phase were provided by the provincial authority. In 1983, despite the progress of the pilot phase being limited, Government allocated substantial funding for an expansion into a provincial programme. The domestic funds were channelled through MEWRD who were to reimburse DDF for labour and transport costs over and above their normal operations. However, during 1984 no internal funds were allocated by DDF to well sinking, despite requests from district authorities and by 1985 the MEWRD funding was exhausted. The programme came to a standstill. New funding was obtained in 1986 and the programme was restarted (MEWRD, 1984/87). During much of this period the security situation in Matabeleland was very uncertain as dissidents were active in the area.

d) Objectives and Target Groups

The objectives of the programme and target groups were clearly stated in the project proposal: To improve access to clean water supply for people living in the communal areas of Matabeleland; to establish a well digging capacity in each district; to coordinate water development in order to optimize the use of ground water; to provide limited support and equipment to rural groups who were motivated to develop their own water supplies through well digging; to involve communities in order to reduce installation and maintenance costs; to support Health Assistants and Village Health Workers in providing complementary health and hygiene education (Williams, 1982).

e) Integration of Water, Sanitation, Health and Other Sectors

The project had a fairly narrow water focus. The project design envisaged sanitation and health education components being undertaken by the MOH as parallel and complementary activities. However, these links were not well established. Other linkages were formed to agriculture; the project supporting cattle watering and limited small scale crop production (Boydell, Cross & Skoda, 1985).

f) The Extension Strategy

There was no formal extension strategy as such. During the project launch workshop, district based staff, mainly health assistants and DDF Field Officers together with political leaders, were briefed on the project. It was agreed that they would inform communities that the project existed and that it could provide assistance in constructing a well. The community should if interested form a water or well committee, choose a site for the well and after approval dig the first four metres or until reaching solid rock. The project would then provide a well sinking team with equipment and explosives, the community would accommodate the team and provide additional labour and materials. On completion DDF would install a pump and headworks (Williams, 1985).

g) The Present Status

By September 1985 250 wells had been constructed (of which less than 10% were dry) and a further 300 were under construction. Extensive training of well sinkers and supervisors had been carried out and the DDF had moved some way toward institutionalizing the wells programme into their day to day operations (MEWRD-NMPRWSS, 1985). More recently efforts were made to establish a maintenance structure for the hand pumps that had been installed (Williams, 1986).

12.2 The Planning Phase

a) Base Line Data and Feasibility Studies

Base line data was not collected nor were feasibility studies undertaken. However, the project's development was greatly influenced by the joint World Bank-WHO Sector Study carried out in 1982 (Vogel *et al*, 1981) which stated that in future sector development emphasis should be on appropriate technology. This diverted the programme from borehole drilling to well sinking.

b) Project Planning

The original project plan was largely concerned with the division of institutional responsibility and did not provide an implementation programme or strategy, nor did it try to balance proposed inputs and expected outputs. The original proposal called for 1,300 wells to be constructed by 1983 after an initial pilot period of three months during which 40 wells would be sunk. Later revisions projected construction of over 4,000 wells by 1986. In reality the programme delivery strategy evolved over the first year or more of implementation (Williams, 1982. Boydell, Cross & Skoda, 1985).

c) Community Participation in Planning

Community participation in planning existed at a modest level. The decisions to be taken were: to participate or not; where to site the well; who should be well committee members: how to organize and manage the inputs expected from them. At a higher level, the elected representatives of the community, the district councillors, had some influence in the planning of which areas the programme should concentrate.

d) Choice of Technology

The technologies of interest in the programme were the well sinking technique and the handpumps that were subsequently installed on the wells. Wells are common

source of water in rural areas and are seen throughout Zimbabwe. Well sinking is a traditional skill; and deep wells with high standards of construction can be seen. However, there is a limit to the depths that can be achieved using traditional techniques particularly in the rocky areas of southern Zimbabwe where ground water is at a considerable depth. During the 1950's the previous Rhodesian Government launched a deep well sinking project in Matabeleland which consisted of constructing deep wide-diameter wells using diesel driven compressors and compressed air drills and picks. During the 1960's and 1970's, borehole drilling came into vogue and the Governments well sinking programme declined. In 1980 the LWF launched a water supply project in the Gwanda and Beit Bridge areas of Matabeleland where they found a number of unemployed miners who had been trained in the numerous small mineral mines that were common in the area before Independence. Many of these miners had blasting licenses issued by the Department of Mines. Hence as borehole drilling equipment was not available a deep well sinking programme using explosives was developed. The model developed by the LWF was adopted without modification by UNICEF.

After the community had dug four metres or so down to solid rock, a well sinking team consisting of a licensed blaster and three labourers took over. They were equipped with a windlass and 50 litre steel mining bucket (or kibble), drilling chisels (or steels), steel formwork for lining the upper less stable part of the well with concrete. Explosives and detonators were supplied by the supervisor as required. The supervisor overlooked the construction of ten or more well sites at any one time. Blasting holes were chiselled by hand some two feet deep in the bottom of the well. Gelignite was used to fracture the rock which was winched out using the kibble. The team was paid Z\$38 per metre excavated through rock and Z\$12 per metre for concrete lining. After water was struck sinking continued, water and rock being removed in the kibble. The

well was considered complete when 5 cubic metres per day could be abstracted. On completion of the well the community transported the equipment to the next site. A second team of DDF artisans, usually a plumber, mason and two labourers, then came along to cast a concrete cover slab and to install the handpump (Williams, 1985).

The selection of a handpump was the second technology choice made in the programme. Two types were used. For deeper wells the Bush Pump was installed, whereas, in shallower installations the Nsimbi was the pump of choice. The Bush Pump is a robust piston pump developed in Rhodesia during the 1930's by a Mr Mergatroyd, an engineer serving in the colonial government. The pump which uses wooden blocks for bearings has become accepted as standard for use throughout Zimbabwe. Its disadvantage is the difficulty in maintaining the underground components. The Nsimbi Pump is a lighter direct action pump recently developed and manufactured by the LWF as a part of their programme. UNICEF have adopted the design without reservation. Its disadvantage is that being relatively new, communities (and Government) were less familiar with its maintenance (Morgan, 1985/87).

12.3 Implementation

a) Donor, Community and Government Inputs

The contributions provided to the programme by the three participating groups were:

UNICEF provided: the catalyst for the programme; technical assistance in the form of a project officer; finance; materials including cement and reinforcement for concrete, explosives, pumps; equipment including a vehicle, windlass and mining buckets, tools, formwork for the concrete lining in wells; and support in developing health education and training materials.

The Community provided: labour for moving the equipment, digging the first four metres or so, collecting locally available materials such as sand and stone; they

sited the well and formed well committees; provided food and accommodation for the well sinkers; and constructed a pavement of stones and a fence around the well; they also agreed to maintain the well and pump in the future.

Government provided: finance; other equipment and services such as stores, transport; labour for supervision and installation of the pumps; administration of the well sinkers' contracts; training of well sinkers; and extension and promotional support (Williams, 1985).

b) Institutional Relationships & Managerial Arrangements

The UNICEF project officer was attached to the MEWRD's provincial office through which Government's funds were to be channelled. It was arranged that the DDF should be responsible for the technical supervision and management of the well sinking operations through their district offices and workshops. DDF were also expected to maintain records of stores used and progress made in well sinking as a basis for paying the well sinkers. The MOH, through their health assistants, provided assistance to communities in the completion of their inputs or contributions to the well construction, mainly the building of fences and aprons. Whereas, the village health workers were expected to lead the hygiene education activities and become members of the wells committee. The district administration, that is, the councillors, the District Administrator, and Local Government Promotion Officers were responsible for promoting the programme and mobilizing the community to undertake the initial steps of excavation and collection of materials.

c) Communications and Training

Communications activities within the project can be considered in three categories; mobilization of the communities; training of supervisors, well sinkers, pump fitters; and training of the community in pump maintenance and hygiene. Community mobilization was the responsibility of district authorities as described above. Councillors

participated in a three day seminar during which they were briefed on the programme and their expected role. Armed with this, they together with Local Government Promotion Officers in turn briefed community groups on an ad hoc basis during political meetings and visits to villages. After the preconditions for participation had been fulfilled by a community, the councillors reported a positive community responses to the district commissioner and hence to the project officer.

Training activities within the programme were much more formalized particularly for well sinkers who attended courses and lectures on the use of explosives and well sinking techniques. They were then attached to an experienced well sinker for four months or so until passing a Department of Mines licensing test for use of explosives. To date some 80 well sinkers have been trained. Training of DDF supervisors and pump fitters was also formalized and structured in courses held in the DDF provincial workshop. Pump maintenance courses for community based minders and second level Ward based pump repairers were carried out from time to time. To date six courses have been run, two jointly with LWF. A further level of communications or dialogue within the project was hygiene education and technical support in the completion of the facilities. This was led by MOH staff. Health assistants worked with the community to build an apron and fence around a well, and in parallel village health workers often joined the well committees in order to promote hygienic practice (UNICEF, 1984/87. Williams, 1985).

d) Credit and Finance

The programme was jointly financed by UNICEF and Government, during the period July 1983 to June 1986, UNICEF disbursed some Z\$370,000 to the project, whereas Z\$750 000 was disbursed by Government, less than a half of the Z\$1.6 million allocated. Credit was not provided to the communities involved nor was an attempt made to recover any costs. Although the communities cash contribution was

small, some Z\$200 per well, it provided a significant indicator of willingness to pay (UNICEF, 1984/87).

12.4 Findings and Results

a) Achievement of Goals and Objectives

The success of the project can be viewed in two ways; in terms of numbers of wells constructed, the project failed to achieve its targets. By the end of 1986, of the the planned 4,160 wells, less than 15% had been constructed, even though the target had been reduced during a mid term project review. Furthermore, the project failed to disburse the funds allocated to the activity by Government. However, at a second level the project has had remarkable success in developing the institutional capacity of Government to implement a wells programme. It has also proved that well sinking was a viable and cost effective technology for providing water to rural communities. Indeed, the project did provide water to a significant number of people which, given the security situation, is a remarkable achievement in itself. Other developmental impact on the communities is hard to detect. However, the project has encouraged self reliance and demonstrated the benefits of communal endeavour (Boydell, Cross & Skoda, 1986).

b) Acceptance and Use of Technology

The well sinking technique developed by LWF and UNICEF has proved to be a robust, viable and cost effective technology option for supplying water to rural communities. The costs of a well were estimated to be in the range of Z\$1,500 to Z\$2,000. This should be compared to the costs of a borehole which were estimated to be in the range of Z\$8,000 to Z\$13,000 for a comparable installation. Of the wells sunk, less than 10% were abandoned during construction or were dry. The wells also exhibited a high degree of user satisfaction particularly in communities where the carrying distance for water has been

significantly reduced. However, one constraint noted was that the apron and fence which are a part of the head works were rarely completed to a satisfactory standard. As regards the pumps themselves, it was found that over 80% of the Bush Pumps surveyed were functioning and delivering water. However, almost all the sample had defects due to poor installation and lack of simple maintenance such as bolts needing to be tightened. Generally communities found the pump satisfactory, but some found it difficult to operate, on investigation it was found that this was often due to faulty installation (Boydell, Cross & Skoda, 1986).

c) Maintenance, Cost Recovery and Replicability

Recovery of costs of the programme was not attempted in any form. Any replication would rely on a continued subsidy from Government or donor grants. Establishing a maintenance structure for hand pumps was an issue and problem that the programme tried to address throughout this period. Based on the institution building philosophy it was felt that the overall responsibility for maintenance rested with Government (DDF), a continuance of the existing situation. However, it was also realized that present DDF structure could not possibly cope with the rapid increase of handpumps in rural areas both physically and financially. UNICEF recommended that a three tier maintenance structure be established. At the bottom level a community pump minder would be responsible for day to day preventative maintenance. At the middle level a mobile semi-skilled pump repairer would service 50 or so pumps; the costs of his salary and spare parts being met by the communities. At the higher level, DDF would be distributing spare parts and undertaking major repairs and replacements. The system is being tested in three pilot districts by UNICEF, together with LWF with some success (Williams, 1986).

d) Institution Building and Effect on Policy

The major impact of the project has been in building the capacity of DDF to undertake water development projects

using community assisted well sinking techniques. This was done through a combination of training well sinkers, supervisors, and physical demonstration. The project has also set precedents for interministerial cooperation and collaboration with NGOs. All this in turn has had a significant influence on Government's approach to sector development and allocation of resources (Boydell, Cross & Skoda, 1986).

e) Programme Design

As stated above, the original programme design concentrated on describing the envisaged institutional relationships within the programme and cannot be considered as a comprehensive planning and strategy document. However, it is apparent that the original project concept and design, albeit limited, was particularly poor and unrealistic. The design included a four month lead time to develop a pilot project; overstated targets that could not possibly be achieved with the resources requested. The whole project was contingent on interministerial collaboration for which there was no precedent in an area torn by civil unrest and strife. However, despite all this, the programme continued to be driven along by the simplistic goal of assisting Government to assist communities to build wells (Boydell, Cross & Skoda, 1986).

f) Other Factors

A number of external factors have contributed to the successes and failures of the project. The most apparent example is the success in institution building, which is to a great extent attributable to the dedication of the UNICEF project manager who despite tremendous difficulties, continued to execute the project through the governmental bureaucracy when at times the system could have been bypassed. Some of the less successful components of the project can be related to the lack of security in the project area and the low priority that Government seemingly gave to development in Matabeleland at that time.

12.5 Lessons to be Learned from the Project

A summary of the systems analysis of the project is given in table 22, and depicted in figure 15. Two valuable lessons can be learned from the UNICEF Wells Sinking Programme. First, that a multilateral donor can provide flexible support to a programme focussed on the removal of critical constraints to development at the lower levels of Government, that is at provincial and district level. Second, that local governments can respond and are able to build and strengthen their capacity to plan and implement development programmes. An other important lesson is that community participation in the decision making regarding inputs to a project is critical. The use of well sinking as an appropriate technology which proved to be conducive to community participation and involvement (albeit somewhat sophisticated and heavy to use) was also clearly demonstrated. Other lessons are the critical role of charismatic leadership and the role that the small scale private enterprise can play in water sector development, that is the use of ex-miners for well construction. There are also negative lessons to be learned. The importance and great difficulty in establishing a maintenance structure for the technologies provided under the project, and the effect of poor or illogical programme planning which resulted in the failed to balance expected project outputs against the inputs provided.

Table 22.Summary of Systems Analysis of the UNICEF Project1. Systems Present and Their Function

Two donor who supported the project; a community who participated and were beneficiaries; and Government who executed the project.

2. Actors and Their Roles

Donor: The multilateral - UNICEF who supported the project; the expatriate expert who effectively managed the project; and the miner who dug the wells. The NGO - Lutheran World Federation assisted in training activities.

Community: political representatives; traditional leaders and small community clusters which were the social unit with which agreements were made; and well committees who then operated the well.

Government: MEWRD who executed the project; District Development Fund who provided some supervisory staff who helped in field activities; and health assistants who occasionally supported the projects promotion.

3. Leaders and Accountability

Donor: The expatriate expert who was accountable to the donor country office and MEWRD.

Community: Traditional leaders who had limited accountability to the community.

Government: the provincial water engineer and HQ project officer who were accountable to the chief water engineer.

4. Perceptions and Self Interest

Donor: That water scarcity was a major problem and that the donor could support the Government in its provision. That working with community groups using appropriate technology was an effective strategy in doing this. To maximize their programme profile.

Community: to maximize the aid provided by the donor in order to improve their living conditions and save their cattle.

Government: to maximize the aid from the donor in order to be seen in solving the drought problems of Matabeleland.

5. Goals and Criteria of Achievement

Donor: number of wells constructed.

Community: continuous water supplies particularly for cattle.

Government: number of wells constructed and visible activities of drought relief in Matabeleland.

6. Problem Definition and Solution

Donor: by the expatriate expert.

Community: problems and solutions were not defined internally, however small community groups were assisted in vocalizing their water needs by Government field workers.

Government: by the provincial water engineer.

Table 22 Continued7. System Interaction and Boundary Spanning

There was substantial interaction between the donor and Government systems as the donor expert was placed in the Government structure. The interaction between both the donor and Government systems and the community systems was restricted to contacts through the Government field workers who met with politicians and small community groups.

8. Commonality and Conflict

The commonality in all the systems was an appreciation of a need for improved water supplies. However, conflict arose between the donor and Government as it was perceived that Government's extension workers were not doing a good job. Also conflict arose between two Government system actors - MEWRD and DDF who were in competition as to who owned the donor.

Other Evaluation Criteria

9. Project objectives clearly defined?.....No.
10. Sufficient resources allocated?.....No.
11. Any baseline or feasibility studies?.....No.
12. Links established to other sectors?.....No.
13. Productive capacity improved?.....No.
14. Role of technical assistance and NGOs?.....TA played a major role in the project, an NGO also assisted in training activities.
15. Role of Women?.....Not emphasized.
16. Role of private sector?.....Local miners constructed the wells.
17. Appropriate technology used?.....Yes.
18. Health/Hygiene education provided?.....No.
19. Any costs recovered?.....No.
20. Any monitoring and evaluation?.....Yes.
21. O & M provided for?.....Yes.
22. Identifiable project phases?.....Yes - institution strengthening and expansion.
23. Any role on effects?.....Yes - the project had impact on subsequent DDF programme designs.
24. Water sanitation and education integrated? No.

Figure 15. Systems Diagram of the UNICEF Project.

Government System

Actors:-

Min. Energy & Water Resources

District Development Fund

Field officers

Health assistants

Donor System

Actors:-

The multilateral - UNICEF

Lutheran World Federation

The expatriate expert

Well sinkers

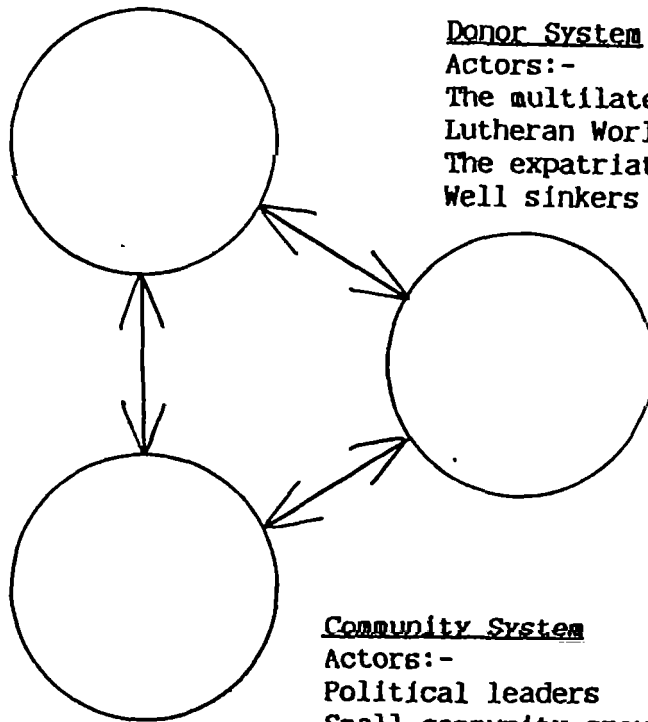

Community System

Actors:-

Political leaders

Small community groups

Well committees

- o 0 o -

Chapter 13

The Lutheran World Federation
Well Sinking Programme in Matabeleland

- o 0 o -



Chapter 13

The Lutheran World Federation Well Sinking Programme in Matabeleland

13.1 Background

a) General Description

Commencing in 1981, the Lutheran World Federation (LWF) directly implemented a rural primary water supply project that was initially located in the communal areas of five districts in Matabeleland North and South Provinces. The programme was expanded during 1983 and 1985 into a further five districts of Masvingo and Midlands Provinces and has more recently expanded into Manicaland Province. The programme consisted mainly of the sinking of deep wells one and a half metres diameter through rock formations using blasting techniques. Communities participated in well sinking by providing labour, materials, and other services. By the middle of 1986 more than 1,500 wells had been constructed at an average depth of some 25 metres (a number of wells reached 35 metres in depth). Water was used for both human and cattle consumption. The programme also included the limited construction of small earth dams, small irrigation schemes and vegetable gardens. It should be noted that the Matabeleland Provinces are the most arid areas in Zimbabwe and were particularly badly effected by the drought during 1982 to 1985 (MEWRD-NMPWSS, 1985).

b) The Donor

The LWF is a large and well known international NGO based in Europe with access to considerable resources. It has directly executed development programmes in a number of countries (or areas) especially where their religious beliefs are held and practised. They work directly with communities in many activities or sectors including relief, agriculture, education, water and sanitation. LWF have an

established country headquarters in Harare and a project office in Bulawayo. More recently additional project offices have been established in Masvingo and Manicaland. The size of the LWF water sector operation in Zimbabwe, in terms of staff and resources, is larger than that of many bilateral donors. In Zimbabwe the Lutheran Church has a particularly large and active following in Matabeleland (LWF, 1985/86).

c) The Development of the Programme

The LWF became active in Zimbabwe immediately after independence in the resettling of refugees returning from neighbouring countries. During early discussions with newly settled Lutheran women's groups in Matabeleland, it was found that of their perceived needs a priority was for water supply in order to grow agricultural produce, as many of the existing boreholes had been damaged during the war. As this coincided with the onset of a drought, the LWF decided to launch a rural water supply and agricultural development programme. A review of the area indicated the potential of wide diameter deep wells for developing water resources particularly as borehole drilling equipment was in short supply. It was also felt that well sinking had more potential for community involvement. The programme initially concentrated in the Gwanda, Beitbridge, Mberengwa, Zvishavane and Mwenezi Districts of Matabeleland where the delivery strategy and well sinking techniques were developed and refined. After two years or so of consolidation the programme was expanded into a further five districts of Masvingo and Midlands Provinces. More recently, the programme has expanded into Manicaland Province in eastern Zimbabwe.

As the programme developed it became apparent that a major constraint to continued operations of the water sources was the maintenance of handpumps. In response to this the Lutherans designated two pilot districts in Matabeleland for the testing of a three tier maintenance system. The programme also included the design and

manufacture of a direct action pump which was used in shallower installations. The Lutheran programme formed strong links with the similar UNICEF wells project which adopted the LWF well sinking techniques. The programme also provided training for well sinkers and pump minders from other NGO supported projects (LWF, 1985/86).

d) Objectives and Target Groups

The objectives of the programme was to provide water supplies to the farmers in the communal areas of Matabeleland for domestic, agricultural and cattle watering uses. Also to encourage the development of small scale agricultural plots in order to improve nutrition and income generation particularly for women's groups. Preference was given to members of Lutheran church groups (LWF, 1985/86).

e) Integration of Water, Sanitation, Health and Other Sectors

The project had a fairly narrow focus on two main activities; the provision of water and the development of the small agricultural plots. Sanitation and health education were not features of the original project design, however, these components were later introduced after criticism from various bodies including the MOH (MOH, 1984/87).

f) The Extension Strategy

The Lutherans initially recruited and trained twenty or so community organizers who, together with or through the local councillors, approached community groups to discuss the project. If a community was enthusiastic they were advised to form a well committee comprising one male and two females who became responsible for organizing the inputs from the group they represented. The community selected a well site together with a LWF supervisor (who was often a water diviner), then commenced the excavation up to the rock head, and collected local building materials such as sand and stone. After this was done they were given

priority in the placement of the next available well sinking team. During well sinking, the community were responsible for accommodating the team, for providing casual labour, and any additional local materials that was required. The well sinking team were supervised and supplied with equipment and explosives by the area supervisor who also measured their work and paid wages. After the well was completed the community organizers made follow up visits to assist in and encourage the setting up of agricultural plots (Jellema, 1983. Oosting, 1983).

g) The Present Status

By mid 1986 over 1,500 wells had been constructed and a further 200 were under construction. However, towards the end of the drought period a number of wells had gone dry and had to be deepened by returning the well sinking team to the sites. Also, the parallel small earth dams project was set back after a number of dams had been washed away during the flash rains in late 1985 which ended the drought. The small agricultural plot component of the project failed to expand at the same rate as the well sinking activities (MEWRD-NMPRWSS, 1985).

13.2 Planning

a) Base Line Data and Feasibility Studies

Base line data collection or feasibility studies were not carried out. However, like the UNICEF programme, the Lutherans were greatly influenced by the World Bank-WHO Sector Study which was the only comprehensive sector overview available at that time. The sector study confirmed that the "appropriate technology" of well sinking should be emphasized in sector development (Vogel et al, 1981).

b) Project Planning

A detailed project plan was prepared, which was very largely concerned with the logistics of implementing the programme of 250 wells in the initial five districts. It

was less concerned with the social and communications aspects of the programme. The plan included; having a number of expatriate programme staff together with local extension workers and supervisors; having one of the expatriate engineers trained in the use of explosives; the setting up of a project office and pump manufacturing depot in Bulawayo; and for a number of vehicles to be provided et cetera (Te Velde, 1983).

c) Community Participation in Planning

Community inputs to the planning process were limited to assisting the field supervisors in siting the wells, choosing the well committee members, and organizing their inputs to well construction. Limited inputs had been made initially by the church women's groups in identifying water shortage as a problem and therefore a potential project. However, no further inputs were made in the programme design (Jellema, 1983).

d) Choice of Technology

The choices of technology of interest are the well sinking technique, and the type of hand pump subsequently installed. Both are described in some detail in chapter 12, which outlines the UNICEF project. The LWF programme independently designed and manufactured a direct action pump "The Nsimbi" which was installed on all their shallow to medium depth pump installations. For the deeper wells the Government standard Bush Pump was used (Morgan, 1985/87).

13.3 Implementation

a) Donor, Community and Government Inputs

The contributions provided by LWF and the community to the programme are detailed below. Government's contribution was limited (Te Velde, 1983).

The Lutherans provided: the catalyst and finance for the programme; technical assistance in the form of a team

of four expatriate experts based in a project office in Bulawayo and a back up administrative staff in the country office in Harare; equipment including that for well sinking, vehicles, hand pumps et cetera; building materials and explosives; and local project staff including well sinkers, supervisors, and community organizers.

The community provided: labour for the initial excavation through soft ground down to four metres or so; locally available materials such as sand and stone; accommodation for the well sinkers; a fence around the well. They also formed a maintenance committee to take care of the well; they may also have assisted in moving the well sinking equipment to the next site. The value of this has been assessed as the cash equivalent of Z\$300. The community also contributed to the salary and tool kit for a pump care taker who serves fifty or so groups.

Government provided: a limited number of Bush pumps through DDF for use in the project; occasional assistance from a VHW or health assistant; in the later part of the programme DDF provided occasional assistance with transport or the loan of equipment (MEWRD, 1984/87).

b) Institutional Relationships and Managerial Arrangements

Initially the programme was managed directly by LWF with little contact being established with the Government structure at any level. Indeed, the LWF structured their programme to operate outside Government with a parallel extension system. After some criticism of their policy LWF attempted to establish a closer relationship with Government by absorbing some of the DDF field officers into the well sinking programme. However, the effect of this was to deplete the DDF of staff. More recently the DDF field officers have been slowly returning to Government with better well sinking experience. LWF formed a better relationship with other donors and NGOs, for whom they provided a good service of training their well sinkers and pump caretakers. The LWF also manufactured and sold pumps to be used in other projects.

c) Communications and Training

Communications and training were strong components of the programme. The community organizers played a central role in informing communities, (often through or in collaboration with the local councillors), about the programme and in stimulating their interest to participate, then in mobilizing the communities to form well committees and to undertake the initial steps of starting the excavation and collecting materials. The training of well sinkers was formalized into structured courses and lectures followed by a period of attachment of the trainee to a qualified well sinker. Training was completed on the award of a blasting license from the Department of Mines after passing a practical test. Approximately 200 well sinkers have been trained. Training courses were also held for a community based pump minder, and a second level of pump care taker who was responsible for fifty or so wells (Dunets, 1985).

d) Credit and Finance

Community credit was not provided within the programme, neither was cost recovery attempted in any form. The programme was financed from external sources channelled through LWF. These included charitable donations, grants from the EEC, Netherlands Government, and DANIDA. The annual budget in 1983 and 1984 was one million Zimbabwe dollars. This doubled in 1985 (LWF, 1984/85).

13.4 Findings and Results

a) Achievements of Goals and Objectives

Without doubt, the programme achieved its immediate objectives of providing water supplies to rural communities in the communal lands in Matabeleland. Furthermore, the programme did a great deal to alleviate the drought situation, thereby keeping alive the vast cattle population in the area. However, the other aspect of the programme, the development of small vegetable gardens had less

impact than was envisaged as it was difficult to maintain the gardens in the drought. The direct institution building aspects of the programme were not obvious, however, a secondary effect was that the well sinking techniques that had been developed in the programme were accepted by Government and other donors as an appropriate water development strategy.

b) Acceptance and Use of Technology

The acceptance and use of technology are discussed in detail in the chapter describing the similar and parallel UNICEF programme. The main issue regarding the choice of technology in the LWF programme was the use of the Nsimbi pump which they had designed and were manufacturing. It was thought by a number of institutions and bodies that local hand pump development in Zimbabwe was quite advanced and that a limited range of indigenous pumps should be adopted as standard in order to simplify future maintenance and operations. The issue of the competition of the Nsimbi pump with the Zimbabwe pumps was not resolved (Morgan, 1985/87).

c) Maintenance, Cost Recovery and Replicability

As cost recovery was not attempted in any form, national replicability would require substantial support from a donor to maintain the present subsidy levels. Furthermore, the programme has had little effects on building Government's capacity to manage and execute the programme so the donor would have to provide continued technical support and management. Three districts were established as pilot areas for developing a three tier hand pump maintenance structure. As an isolated activity this was one of the better aspects of the programme. However, it was done without reasonable discussion with Government whom they assumed would take up the burden of employing pump caretakers and adopting a pump model, the design of which they had not approved. In effect LWF were presenting Government with a fait accompli of some 1,500 handpumps requiring maintaining in the future (Williams, 1986).

d) Institution Building and Effects on Policy

As stated earlier, the programme had little direct institutional building effect other than the training of DDF field officers in the latter part of the programme. However, the programme had two distinct effects on sector policy. Firstly, the programme, together with the parallel UNICEF activities, proved to Government that wide-diameter deep well sinking by blasting was a viable technology for developing rural water resources. This was subsequently adopted for broad implementation by the DDF as a component of their regular activities. Secondly, the LWF caused the debate on how best to establish a maintenance system for hand pumps. This led to a consensus that a national approach should be designed and adopted (MEWRD, 1984/87. MOH, 1984/87).

e) Project Design

The internal logistics of the programme were well designed and planned which resulted in the targeted number of wells being constructed within a relatively short time period. The original concept of using water to promote vegetable gardens, and thus develop better nutrition and generate income, was overwhelmed in the well promotion process and relegated to being a sub component of the small earth dams project which declined in importance with the successes of the wells programme. The programme design did not encompass any higher goals such as institution building or providing a catalyst in the rural development process.

f) Other Factors

One of the main factors in the success of the programme was the dedicated leadership and management of the expatriate team who passed on to their local employees a strong sense of purpose. The programme also benefited from being outside the bureaucracy of Government and therefore having more flexibility to administer and manage staffing and procurement of materials et cetera.

13.5 Lessons to be Learned from the Project

The summary of a systems analysis of the project is given in table 23, and shown diagrammatically in figure 16. A valuable lesson that can be learned from the Lutheran Wells Sinking Programme is the effectiveness of well established NGOs in the design and execution of a rural water and sanitation programme. An international NGO programme can be as extensive, and as professionally managed as a bilateral programme, however, a major pitfall is that the NGOs can be perceived as working outside of, or in competition with Government which negates many of the potential developmental benefits. In this project, no institutional strengthening or capacity building was achieved. In fact, conflict was created by the NGO providing alternative technologies to those which had become standardized in the country, this contributed much to the difficulties experienced in trying to establish a pump maintenance system in the project areas. More positively, the LWF programme confirms the findings in the UNICEF project review, the importance of community participation in planning and decision making, and the use of well sinking as an appropriate technology that is particularly conducive to community participation and involvement. Also seen was the role of charismatic leadership; the importance of women as targets for the extension and education programmes; the use of the private sector, for example well sinkers; the benefits of logical and local level programme planning and the strength of an area based approach. Water and sanitation was shown to be a viable entry point for broader developmental activities.

Table 23Summary of Systems Analysis of the LWF Project1. Systems Present and Their Function

A donor who managed the project; a community who participated and were beneficiaries; and Government who played a peripheral role.

2. Actors and Their Roles

Donor: The NGO - Lutheran World Federation which was the focal point for the project; the expatriate project team who managed the project; field supervisors and community organizers who promoted the project and supervised activities; and the well sinkers or miners who constructed the wells.

Community: traditional leaders and small community clusters which were the social unit with which agreements were made; and religious groups.

Government: District Development Fund who provided some supervisory staff who helped in field activities; and health assistants who occasionally supported the projects promotion.

3. Leaders and Accountability

Donor: The expatriate team who had limited accountability to their headquarters and financiers.

Community: Traditional leaders who had limited accountability to the community.

4. Perceptions and Self Interest

Donor: That water scarcity was a major health problem and that the NGO had some responsibility for its provision. That working with community groups was an effective strategy in solving this. To maximize the donors profile.

Community: to maximize the aid provided by the donor in order to improve their living conditions and save their cattle.

Government: that the LWF were usurping Governments responsibilities.

5. Goals and Criteria of Achievement

Donor: unspecified health improvement; number of wells constructed.

Community: continuous water supplies particularly for cattle.

Government: visible activities of drought relief in Matabeleland.

6. Problem Definition and Solution

Donor: by the expatriate team.

Community: problems and solutions were not defined internally, however small community groups were assisted in vocalizing their water needs by community organizers.

Government: were excluded.

Table 23 Continued7. System Interaction and Boundary Spanning

There was little if any substantial interaction between the donor and Government systems. The interaction between the donor and community systems was through the community organizers and field supervisors who met with traditional leaders and small community groups.

8. Commonality and Conflict

The commonality in the donor and community systems was an appreciation of a need for improved water supplies. However, conflict arose between the donor and Government as it was perceived by some Government officers that the donor was usurping Government's role and responsibilities. However, Government used the LWF project to demonstrate that they were addressing the drought problem in Matabeleland.

Other Evaluation Criteria

9. Project objectives clearly defined?.....Yes.
10. Sufficient resources allocated?.....Yes.
11. Any baseline or feasibility studies?.....No.
12. Links established to other sectors?.....Yes - agriculture.
13. Productive capacity improved?.....No - however project was linked to agricultural groups.
14. Role of technical assistance and NGOs?.....An NGO was the primary force in the project and substantial expatriate TA was mobilized.
15. Role of Women?.....Not emphasized.
16. Role of private sector?.....Local miners constructed the wells.
17. Appropriate technology used?.....Yes.
18. Health/Hygiene education provided?.....No.
19. Any costs recovered?.....No.
20. Any monitoring and evaluation?.....No.
21. O & M provided for?.....Yes.
22. Identifiable project phases?.....Yes - the expansionist activities of the donor.
23. Any role on effects?.....Yes - the project had impact on subsequent UNICEF project designs.
24. Water sanitation and education integrated? No.

Figure 16. Systems Diagram of the LWF Project.

Donor System

Actors:-

- The NGO - Lutheran World Federation
- The expatriate project team.
- Field supervisors.
- Community organizers.
- Well sinkers.

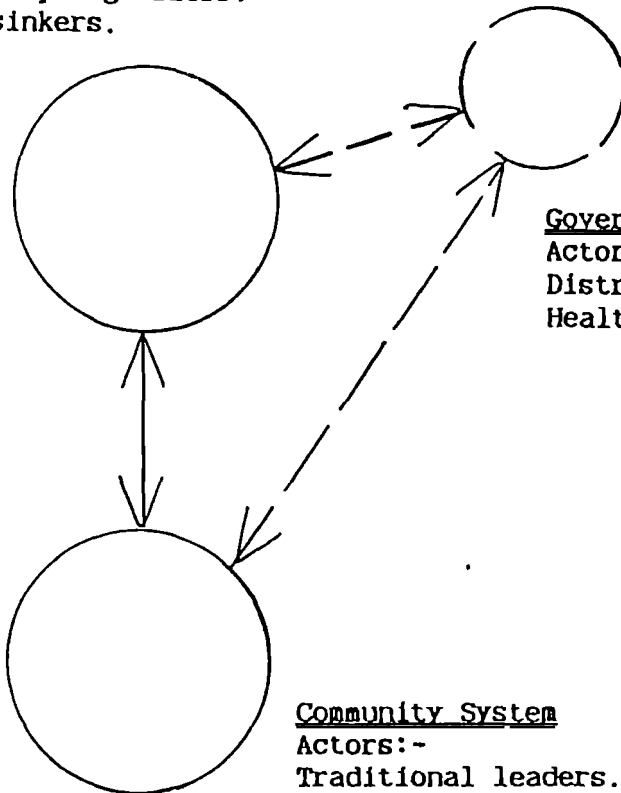

Government System

Actors:-

- District Development Fund.
- Health assistants.

Community System

Actors:-

- Traditional leaders.
- Religious groups.
- Small community groups.

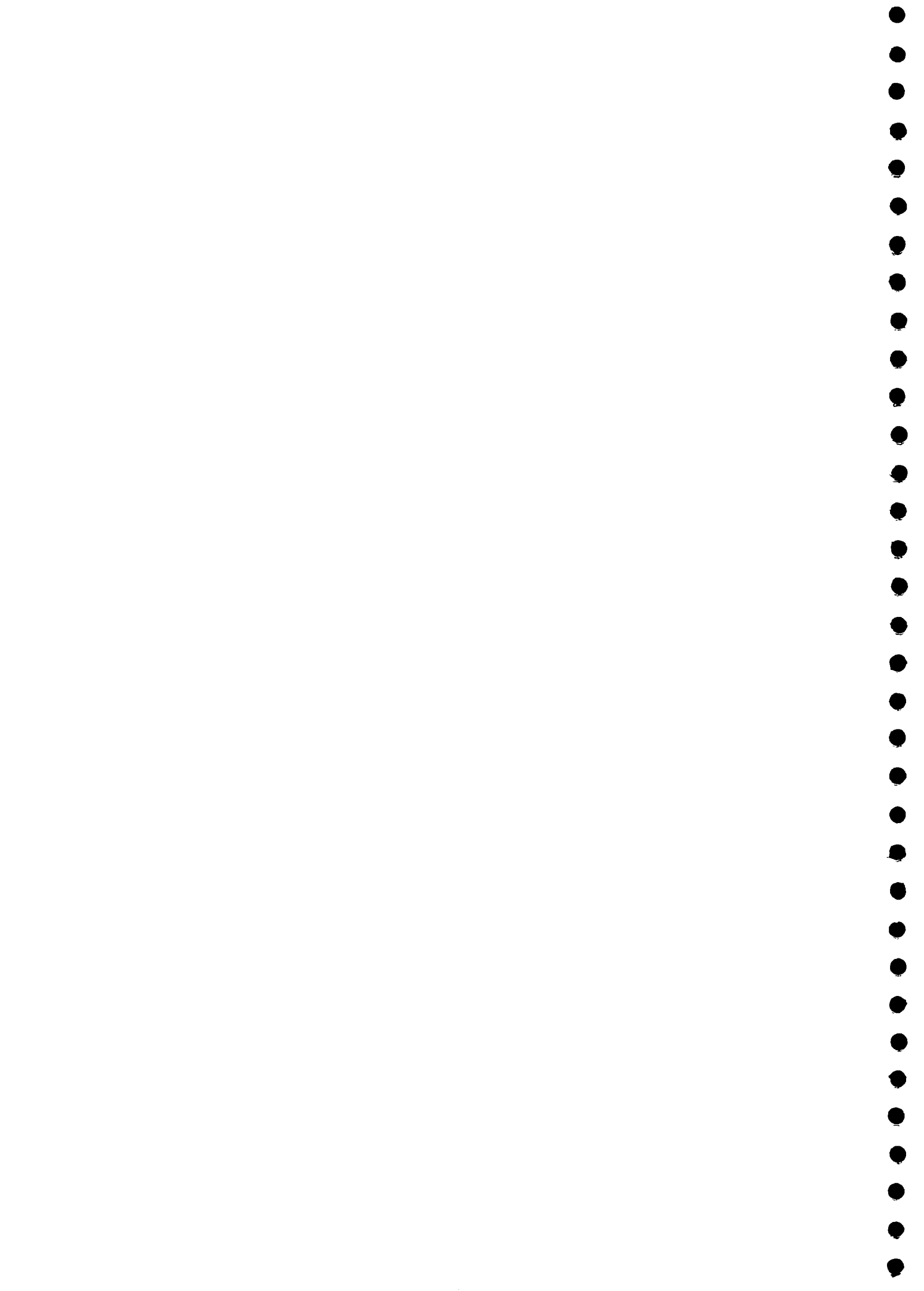

- o 0 o -

Chapter 14

The NORAD Crash Borehole Drilling
and Long Term Programme
in
Mashonaland and Manicaland Provinces

- o 0 o -

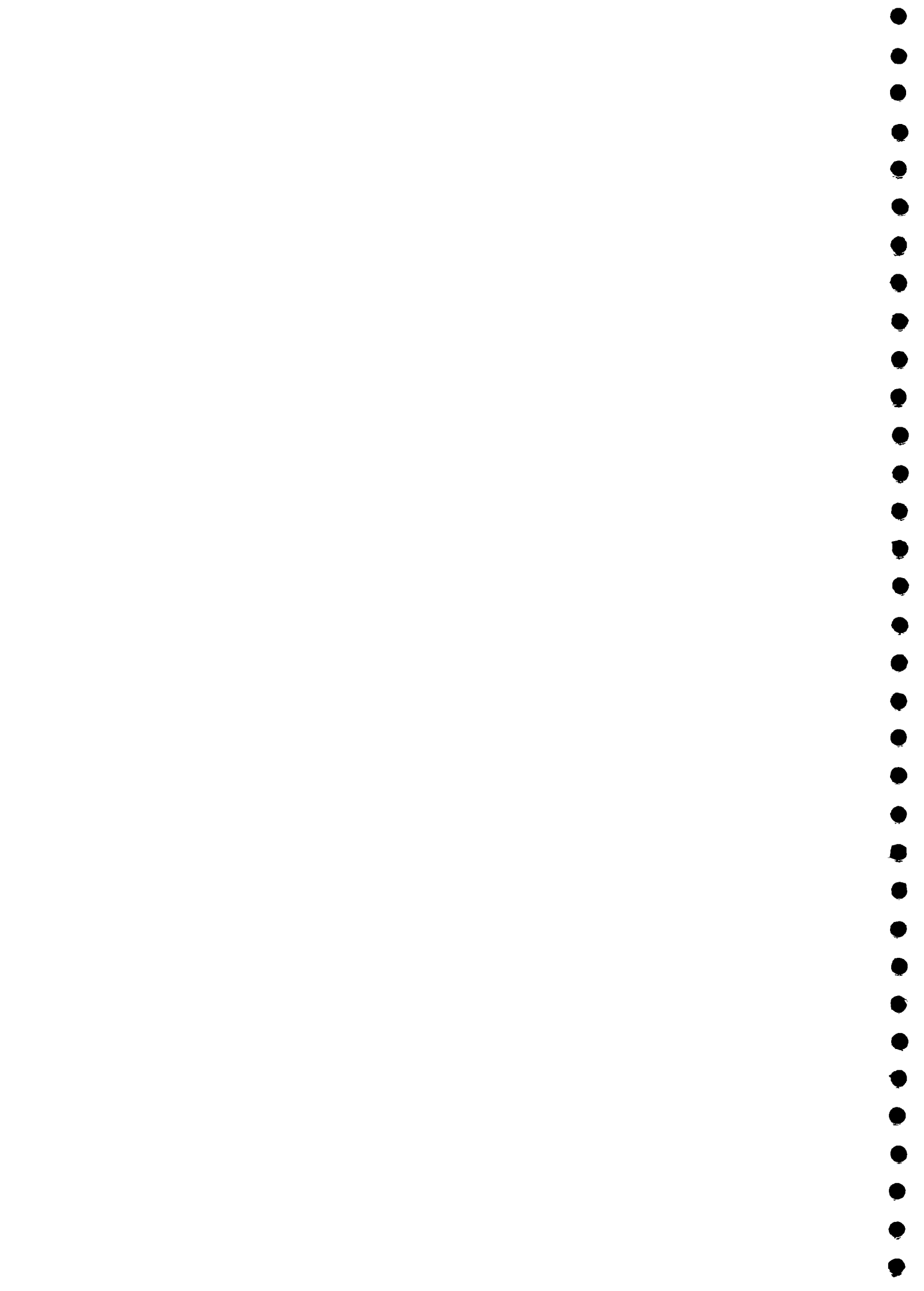

Chapter 14

The NORAD Crash Borehole Drilling and Long Term Programmes In Mashonaland and Manicaland Provinces

14.1 Background

a) General Description and Development of the Programme

The Norwegian bilateral aid agency NORAD has been active in Zimbabwe since immediately after Independence. Initially it provided support to a rural reconstruction programme executed by the DDF. A major part of the reconstruction was repairs or replacements of water supply facilities damaged during the Independence struggle. Part of this support included the strengthening of DDF's capacity to drill boreholes through the provision of drilling equipment and training. During 1981, NORAD made a policy decision to provide future support to the water sector in Zimbabwe and supported the preparation of a sector master plan as a blue print for their future activities (MEWRD-NMPRWSS, 1985). The preparation of the master plan coincided with a drought period and with a large under-spending of the NORAD funds supporting the DDF. Also, additional NORAD water sector programme funds became available. At this point in 1984, a decision was made to support a crash borehole drilling programme (CBHDP) that would alleviate the drought and also absorb the excess funds (NORAD, 1984/87). As the MEWRD were thought to be the Governmental body with the greatest expertise in borehole drilling, they were nominated as the programmes executing agency. However, the operation was designed by Norwegian consultants and the works carried out by a contractor. The programme included the drilling of some 450 boreholes in Mashonaland. Further funds became available in 1985 and the programme was extended into Manicaland where a further 200 or so boreholes were drilled. A nominal community

participation component was included in the first phase of the programme in compliance with the recommendations of the NMPRWSS. However, in the programme extension, the implementation strategy was substantially modified to involve other ministries in order to strengthen the community participation, sanitation and education elements of the programme (MEWRD, 1985).

During 1986, as the NMPRWSS was nearing the end of a long process of discussion and modifications, NORAD commissioned consultants to design a long term sector support programme. It was decided that, in order to consolidate the water supply services provided in the crash borehole programme, any future activities should continue to concentrate in the Mashonaland provinces. It was also felt that an integrated approach should be taken, that is, water supply sanitation and health education should be provided simultaneously by the various ministries concerned, coordinated by the MLGRUD. In 1987 a Norwegian programme manager was established in the MLGRUD and the influx of funds escalated (NORAD, 1987). The programme continues with substantial funding and strong expatriate support which Government seems to have problems in absorbing. The development of the NMPRWSS and the planning of Norwegian aid to the sector is discussed fully in chapter 6.

b) The Donor

NORAD, the Norwegian bilateral aid agency, has funded development programmes in East and Southern Africa and has been particularly active in the water sector in Kenya, Tanzania, and Zambia. The programmes are typically managed by expatriate experts seconded to the executing ministries of Government, designed by consultants, and fairly narrow in focus. In Zimbabwe, NORAD's interests are represented by a programme manager in the MLGRUD and experts seconded to the DDF and MEWRD. The majority of the programme design and supervision has been carried out by the Norwegian consultants Interconsult (NORAD, 1984/87).

c) Objectives and Target Groups

The objective of the CBHDP was to provide additional water supply points for the residents of communal areas in Mashonaland (and later Manicaland) in order to relieve the distress caused by the drought. However, the longer term programme had a somewhat broader concept of integrating water supply sanitation and education implementation in order to improve health. The target group remained the residents of communal areas, but women were singled out as being the main beneficiaries and the primary channels for effecting behavioural changes. A further objective of the long term programme was to accelerate the provision of water and sanitation services through improving the project implementation capacity of sector ministries, and by improving inter ministerial coordination and clarifying institutional responsibility (MEWRD, 1985).

d) The Integration of Water, Sanitation, Health and Other Sectors

Within the CBHDP there was no attempt to integrate the provision of water supplies with any other sector. However, some hygiene education was provided by a "community participation team", formed under the programme, and by local HAS and VHWS mobilized to support the activities through the MOH. As part of the CBHDP extension activities, demonstration latrines were constructed at each borehole site in Manicaland by the MOH (MEWRD, 1985). In the long term programme design, the integration of the provision of water sanitation and education is the cornerstone of the delivery strategy. However, it is not envisaged that the programme would be linked to other activities such as agriculture, primary health care or to a broader rural development concept (NORAD, 1987).

e) The Extension Strategy

The original extension strategy used in the CBHDP can be summarized as follows; a list of proposed borehole sites was submitted to the MEWRD by the District Administrators,

the list was then refined to potential sites by the consultants using hydrogeological maps; a community participation unit was established that made the initial contact with the communities informing them that a drilling team would be coming to the village and of the contribution to the building of the water point that was expected from them. The community was also encouraged to form a water committee with whom a contract was agreed that defined the roles and responsibilities of both parties. A borehole siting team then visited the potential sites and together with the water committee agreed the borehole location. A drilling team would drill the borehole followed by a team who would install the hand pump. The community would then assist in completing the headworks, that is, they would construct the apron, a washing slab and a fence, then assume responsibility for taking care of the pump and minor maintenance such as greasing and tightening bolts. HAs and VHws from the MOH were then supposed to follow up with health and hygiene education visits (MEWRD, 1985).

During the extension of the programme into Manicaland the strategy was modified in a number of ways. Borehole drilling was done by the MEWRD's own drilling crews. A sanitation component was added that included for the construction of ten demonstration latrines at each pump location constructed by the MOH. District level coordination committees were established attended by MOH, MEWRD, local LGPOs and the consultant who continued to provide the borehole siting and community participation teams, and logistical support such as procurement of materials. In the long term programme, the basic principle adopted in the implementation strategy is that the programme should be executed through the sector ministries coordinated by a programme manager based in the MLGRUD, which would also provide support from the district administrative structure. MOH were to implement the sanitation component; MCDWA were to look after extension, community development and women's issues with DDF and MEWRD constructing the water supplies. NORAD also provided

technical support through a number of expatriate advisers and consultants (NORAD, 1987).

14.2 Planning

a) Base Line Data and Feasibility Studies

During the preparation of the NMPRWSS a number of comprehensive sector studies were carried out including: a socio economic survey; a "willingness to pay" study; a health profile; a survey of existing service levels; and a series of project case studies. This should have provided a good basis for the design of a programme. However, little of the data was used in the design of the CBHDP or the long term programme (MEWRD-NMPRWSS, 1985).

b) Project Planning

Detailed project plans were drawn up for the CBHDP and the long term programme. The plans were mainly concerned with the logistics or inputs required in order to disburse the large amounts of funds that had been allocated to the programmes. Many of these inputs were in the form of technical assistance and other support to be provided by consultants. The plans had little regard for the implementation capacity of the executing ministries (Haugland, 1984. NORAD, 1987).

c) Community Participation in Planning

Communities were not involved in the conceptual planning in any of the programmes. In the CBHDP, participation existed only at the level of communities being involved in borehole siting, forming water committees, and providing materials and labour for construction. However, in the long term programme, community participation is subject to the leanings and policies of the executing ministries. MOH and MCDWA, the social services ministries actively promote participation, whereas, the technical ministries, MEWRD and DDF, are more reluctant to involve communities.

d) Choice of Technology

Generally, NORAD followed the technology trends established in Zimbabwe with the Bush Pump and the Blair latrine being specified as standard equipment in the programmes. However, in both the NMPRWSS and the long term programme there was a strong leaning towards the higher water supply technologies such as drilled boreholes and piped schemes and much less of an emphasis on simpler technologies such as wells and springs, the potential for which was not explored (Morgan, 1985/87).

14.3 Implementation

a) Donor, Community and Government Inputs

During the Mashonaland Crash Borehole Drilling Programme the contributions of the three participating groups were (MEWRD, 1985):

NORAD provided: funding for the consultant who designed the programme and supervised the drilling contractor and also provided the borehole siting and community participation teams; funding of the drilling contractor; and technical assistance staff in the MEWRD.

The community provided: labour and locally available materials for the construction of an apron and washing slab adjacent to the borehole and a fence. The community also formed a water committee and assumed responsibility for taking care of the pump and preventative maintenance such as greasing.

Government provided: the initial lists of possible borehole sites; MOH health assistants who helped communities in the construction of the head works; and other limited inputs such as LGPOs assisting the community participation team. During the extension of the programme into Manicaland, roles changed significantly. Government provided the drilling equipment and crews, and the consultants' inputs were reduced to providing the borehole and community participation teams. The MOH's contribution

also increased with the addition of the sanitation component. In the long term programme NORAD increased its technical assistance support to all the involved sector ministries and provided additional assistance to the MEWRD at provincial level.

b) Institutional Relationships and Managerial Arrangements

The CBHDP was managed directly by a Norwegian consultant company, and liaison with the counterpart ministry, MEWRD was routed through a Norwegian technical assistance expert seconded to the ministry. In the CBHDP extension, Government took a stronger management role and the existing Manicaland provincial inter-ministerial water committee was used to coordinate the activities of the various parties involved, MOH, MEWRD and the consultant. District level coordinating committees were also formed. For the long term programme the IDWSSD National Action Committee was used as the managing and coordinating body. This is discussed in detail in chapters 5 and 6 which describe the NMPRWSS and the National Action Committee. An additional technical assistance expert was provided by NORAD. He was seconded to the MLGRUD as programme manager and became the de facto chairman of the NAC, diverting most of the committees energy into managing the NORAD programme (MOH, 1984/87).

c) Communications

Communications within the CBHDP consisted of, firstly, informing the community that drilling equipment would be arriving in their area, and what they would be expected to do. This was carried out by the consultants team. Secondly, the MOH supervised the completion of the head work and provided some hygiene education instruction (also latrine construction training in the programme extension). Thirdly, pump maintenance training was provided. Good training materials were developed by the consultant for use in the extension work. In the long term programme, it was envisaged that communications support and outreach would be

provided by the individual ministries. However, NORAD believes that the MCDWA should have a strong role in execution of the activities, and that yet another Norwegian should be provided to assist them in developing a water sector communications strategy and structure to support the programme.

d) Credit and Finance

Credit was not provided for the use of the beneficiaries in the project, neither was any attempt made to recover costs. The community contribution to the completion of the water points in the CBHDP has been estimated to be the equivalent of some Z\$500 per water point. The Norwegian funds granted to the Zimbabwe Government in support of the programmes were estimated to be some Z\$20 million for the master plan, Z\$25 million for the CBHDP and its extension, and a further Z\$20 million for the long term programme up to 1988.

14.4 Findings and Results

a) Achievements of Goals and Objectives

The CBHDP certainly achieved its short term objective of improving the levels of water supply services in the then drought stricken areas of Mashonaland and Manicaland. However, in the long term programme the excessive use of consultants and expatriate experts in order to disburse an over generous aid programme appears to have overwhelmed Government rather than building institutional capacity as was intended.

b) Institution Building and Effects on Policy

As stated above, the short term institution building effects of the programme were not apparent and in some ways the programme may have been detrimental to sector development as it has diverted the IDWSSD National Action Committee from its broad sector support role to providing service to the NORAD funded activity (the NAC became known

as the NORAD Action Committee). However, in the longer term it is hoped that sector management restructuring proposed by the master plan, and the provision of all the technical assistance will have a positive impact on further sector development (MOH, 1984/87. MEWRD, 1984/87).

c) Acceptance and Use of Technology

It is worthwhile commenting on the boreholes provided in the CBHDP. In the original project design it was estimated that each borehole would serve some 250 people. However, this proved not to be the case. In reality the siting of the water points was determined by the accessibility of the heavy drilling equipment and many of the points served less than 50 people. The average borehole cost being some Z\$12,000, (ie. the total cost of the programme divided by the number of boreholes constructed), the per capita cost of Z\$240 were unfavourable when compared with deep wells or other technologies. The major complaint of communities was that there were too few boreholes and they were too far from their homes (MEWRD, 1985).

d) Maintenance, Cost Recovery and Replicability

Cost recovery was not attempted in the CBHDP, nor is it a feature of the design of the long term programme. Therefore, replicability is dependent on the continued subsidy from Government or the donor. A programme of this magnitude has established a precedent that is difficult to break in the future. The establishing of a sound maintenance system for hand pumps, although given some attention in the programme design, was of a much lower priority than executing the capital intensive new works and the programme leaves behind an increasing maintenance burden for Government.

e) Programme Design

The design of the CBHDP was a curious mixture of conflicting concepts. The urgency of relieving the drought

situation by a fast moving drilling programme in which four or five boreholes would be completed in one day is some what at odds with the community involvement concept which is of necessity slow moving. The long term "integrated programme" design has paid little regard to the capacity of Government to absorb the level of aid funding, nor has it been responsive to the developmental needs of areas in which the activities took place. This was unfortunate as the concept of implementing an integrated water sanitation and education programme through existing Government ministries is laudable. However, too much was provided too soon. It is significant that much of the data and some of the recommendations in the NMPRWSS were not used or deliberately ignored during the planning of the programmes. It is also significant that NORAD did not attempt to involve CSSD, the NGO which had been successfully involved in the sector in Mashonaland for a number of years (see chapter 9).

14.5 Lessons to be Learned from the Project

The summary of a systems analysis of the programmes is given in table 24, and depicted in figure 17. Four main lessons can be learned from the NORAD Crash Borehole Drilling and Long Term Programmes. First, that donor pressure to absorb and disburse funds, counteracts the design and implementation of good projects, and overwhelms Governments capacity. Second, that fast paced borehole drilling programmes are less conducive to community involvement and participation than other water development techniques, and the the social elements require special attention in such schemes. Third, that centrally prepared water master plans, developed by expatriate consultants are unlikely to be able to take into account the needs of local people and areas and are therefore incompatible with community based developmental activities. Four, that large teams of expatriate technical assistance should not be used in Government line posts to define policy and programmes.

Table 24Summary of Systems Analysis of the NORAD Crash Borehole and Long Term Programmes1. Systems Present and Their Function

A donor who supported and undertook part of the execution of the programmes; a community who participated and were beneficiaries; and Government who executed part of the project.

2. Actors and Their Roles

Donor: The bilateral - NORAD who supported the project; the Norwegian Consulting Company who designed and managed the programmes; expatriate TA personnel in Government who represented the donors interests; short term consultants who were advisers to the donor; and the community liaison team who managed field activities in the crash programme.

Government: MEWRD, MLGRUD, MOH who were the counterpart central ministries with whom agreement were made; Provincial Government who assisted in site selection; LGPOs who promoted the programme at field level; and health assistants who assisted in latrine construction and hygiene education.

Community: Political leaders who were co-opted into promoting the project; traditional leaders and small community groups with which agreements were made; and water/health committees who then operated the pumps.

3. Leaders and Accountability

Donor: The expatriate advisor in MEWRD and the manager of the consultants who were accountable to the donor headquarters and superficially to Government.

Community: Traditional and elected leaders who had limited accountability to the community.

Government: the chief water engineer, provincial water engineer who were accountable to their ministerial headquarters.

4. Perceptions and Self Interest

Donor: That water scarcity was a major problem and that the donor could support the Government in its provision. That a large budget could be disbursed quickly. That Government was incompetent and that a consultant and TA was needed. That NORAD should be the lead donor in the sector. The consultant wanted to maximize profit and ensure continuity.

Community: To maximize the aid provided by the donor in order to improve their environment and living conditions.

Government: To maximize the aid from the donor. To control the sector by securing large external funding.

5. Goals and Criteria of Achievement

Donor: number of boreholes drilled and pumps installed; water committees formed; and budget expended.

Community: continuous and convenient water supplies.

Government: number of boreholes drilled; control of the donor.

Table 24 Continued6. Problem Definition and Solution

Donor: by the consultants and short term advisors.

Community: problems and solutions were not defined, however small community groups were assisted in vocalizing their water needs by LGPOs and politicians.

Government: by the MEWRD and the provincial water engineer; and provincial government.

7. System Interaction and Boundary Spanning

The interaction between the donor and Government systems was superficial as the donor's consultants who were located in parallel to Government had the direct design and supervision role. The interaction between the Government and the community system was also superficial, the contacts being through the Government field workers who met with politicians and small community groups as an adjunct to the donors community liaison team who had direct operational contact with the community.

8. Commonality and Conflict

The commonality in all the systems was an appreciation of a need for improved water supplies. However, conflict arose within the Government system as it was perceived that the donor by operating at provincial level using consultants was bypassing the executive role of the central Government ministries. Conflict also arose within the Government system between MEWRD and DDF as to which should have control of the sector.

Other Evaluation Criteria

9. Project objectives clearly defined?.....Yes.
10. Sufficient resources allocated?.....Yes.
11. Any baseline or feasibility studies?.....Partially as part of the NMPRWSS.
12. Links established to other sectors?.....NO.
13. Productive capacity improved?.....No.
14. Role of technical assistance and NGOs?.....TA played the major role in the project.
15. Role of Women?.....Not emphasized.
16. Role of private sector?.....Contractors drilled the boreholes.
17. Appropriate technology used?.....Yes.
18. Health/Hygiene education provided?.....Partially.
19. Any costs recovered?.....No.
20. Any monitoring and evaluation?.....No.
21. O & M provided for?.....Partially.
22. Identifiable project phases?.....Yes - donor executed to part Government executed.
23. Any role on effects?.....No.
24. Water sanitation and education integrated? Yes.

Figure 17. Systems Diagram of the NORAD Crash Borehole and Long Term Programmes.

Donor System

Actors:-
The bilateral - NORAD
The consulting engineering co.
Short term consultants
Technical assistance personnel
Community liaison team

Government System

Actors:-
Ministry of Health
Ministry of Energy & Water Resources
Provincial Government
Local Govnt Promotion Officers
Health assistants

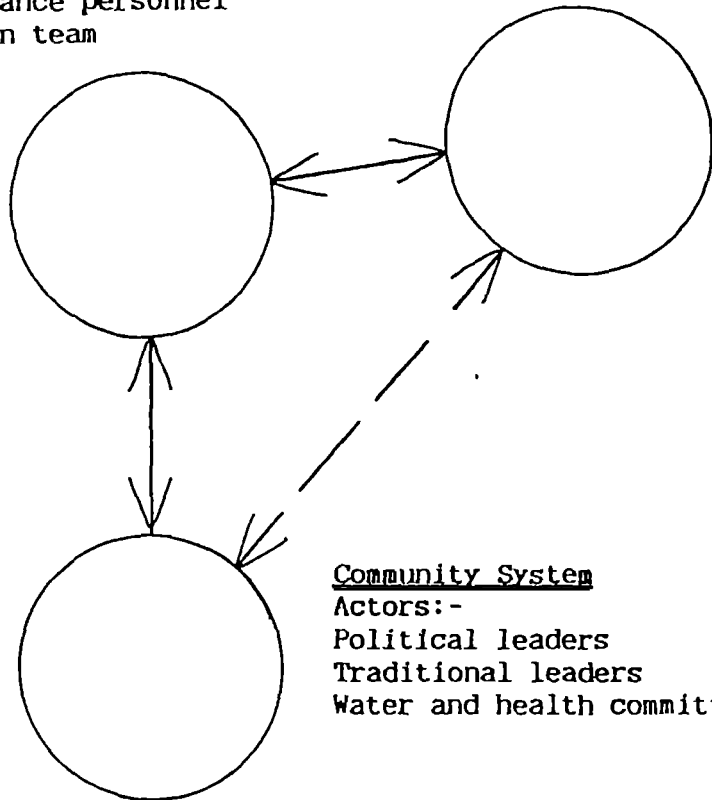

Community System

Actors:-
Political leaders
Traditional leaders
Water and health committees



- o 0 o -

Chapter 15

Other Rural Water Supply and Sanitation Projects

- o 0 o -



Chapter 15

Other Rural Water Supply and Sanitation Projects

15.1 General Description

A number of other rural water supply and sector projects were implemented during the post Independence period. These projects were supported by a mixture of bilateral and multilateral donors and NGOs. The bilateral and multilateral programmes were generally executed by Government, whereas the NGO projects were often executed directly. Some of the larger of these projects are listed below, but, the list is not exhaustive (Boydell, 1986b):

- a) A borehole drilling programmes in Masvingo and Matabeleland South Provinces funded by the EEC and executed by the MEWRD.
- b) A borehole drilling programme in Midlands Province funded by the Japanese bilateral aid agency JAICA, and executed by the MEWRD.
- c) A borehole drilling programme in resettlement areas funded by the British aid agency ODA, executed by MEWRD with ODA technical assistance.
- d) A rural water supply and sanitation project in Midlands and Matabeleland North Provinces funded by DANIDA and executed by the MOH.
- e) A well and borehole rehabilitation and pump maintenance project in Midlands and Matabeleland North Provinces funded by DANIDA through UNICEF and executed by the DDF (this was linked to MOH project above).
- f) A primary health care project in Manicaland Province which had a substantial water and sanitation component funded by SIDA and executed by the MOH.
- g) A primary health care programme in Binga District Matabeleland North Province which had a substantial water and sanitation component funded and executed by Save the

Children Fund UK in a collaborative agreement with the MOH.
h) A primary health care projects in commercial farm worker compounds in Mashonaland Central Province which had a substantial water and sanitation component funded and executed by the MOH.

The early EEC and JAICA funded borehole drilling programmes in Masvingo and Midlands that had been designed immediately after Independence were vertical engineering programmes with little community participation or integration with other developmental activities. However, as a result of a growing awareness of sector issues created by the NAC and the master planning process, the later EEC drilling programme in Matabeleland South was designed with good inter ministerial linkages, community participation and strong sanitation and education components (EEC, 1984/87). The other projects particularly the DANIDA, SIDA, and the Save the Children Fund supported activities are worthy of further discussion.

15.2 The DANIDA Funded Rural Water Supply and Sanitation Projects in Midlands and Matabeleland North Provinces.

DANIDA, which became active in Zimbabwe immediately after Independence, made a policy decision to support the water sector as indicated in their bilateral agreement. The initial involvement commenced with assisting the MEWRD with a feasibility study for a medium sized dams project in Midlands Province. The study was undertaken by Danish consultants who concluded that the project was not viable. However, as programme funds had been allocated to the water sector, pressure was created to find new water projects. This was exacerbated by the under-spending in other sectors. Because of the success of the pilot projects, the MOH had prepared a series of large scale community based rural water and sanitation project proposals for each of the provinces as a means to expand their programme, and were shopping around for support. DANIDA took up two

proposals for Midlands and Matabeleland North Provinces, areas where other donors were not active. The proposals included mainly for the construction of shallow wells, hand augered boreholes and Blair Latrines in two districts in Midlands and one in Matabeleland South. Also, after visits from senior DANIDA staff, a second related project was identified (MOH, 1984/87). It was agreed that DANIDA would fund a borehole and handpumps rehabilitation and maintenance project in the same districts as the MOH activities. The project was executed by the DDF with the funding being channelled through UNICEF in a "noted funds" procedure. UNICEF were involved because of their existing financial and technical support to the DDF in establishing a well sinking programme and a handpump maintenance structure. A systems analysis of the project is presented in table 25, and depicted in figure 18. The most notable features of the DANIDA supported projects were as follows.

The first two years of funding were seen as a preparation period for the long term involvement of DANIDA in the provinces. The initial priorities were to prepare water development plans, district by district, which would define the areas that could be served by different types of technology, shallow or deep wells, hand augered tubes or deep boreholes et cetera, and therefore define the level of inputs required from MOH, MEWRD and DDF. A second priority was to establish a maintenance system for handpumps before embarking on further large scale construction of new facilities. Thirdly, it was felt that the momentum of the MOH should be maintained. A secondary reason for this preparation period was related to the uncertainty of that time, created by the water master planning exercise as to which ministry should take the coordination and lead role in the sector. Project coordinating committees comprising local representatives of the MOH, DDF, MEWRD and MLGRUD and chaired by the District Administrator were set up in each district. These committees were responsible for identifying priority areas and needs, and preparing the programmes operational plan. Technical assistance was provided to fill

skill gaps at the provincial and district level. A hydro-geologist assisted in the preparation of district water development plans, and a community participation specialist assisted the DDF in developing community extension strategies for the handpump maintenance scheme. Within the project, budget funds were set aside specifically for the development and production of training materials. The programme commenced in 1985, and during an evaluation that took place some twelve months later, it was found that the district committees had been successfully established, and district plans for the initial three districts promptly prepared. The execution of the MOH component of the programme was going well. However, the main emphasis had been placed on building latrines (the two year target had already been achieved in Midlands), but the well targets had not been reached. The UNICEF-DDF component has gone very slowly and less than 10% of the proposed programme have been completed. This is mainly due to poor and over ambitious project design by UNICEF (Clausen et al, 1987).

15.3 The SIDA Funded Primary Health Care Programme in Manicaland.

SIDA had been actively supporting the health sector in Zimbabwe since Independence. A major part of this support was the funding of a primary health care programme in Manicaland Province which supported MOH's post Independence shift from urban curative medicine to rural preventative health care. During the 1984 annual bilateral negotiations it was clear that the programme budget was grossly under disbursed, and as a new community based RWSS project proposal had been presented for funding to SIDA by MOH, it was agreed that the existing primary health care activities, and the proposed water and sanitation project, should be combined into a fully integrated primary health programme. During implementation, water and sanitation became one of the programmes most successful aspects. By

the end of 1986 some 800 latrines and 150 wells or springs had been constructed through community participation using the MOH's implementation strategy (SIDA, 1984/87). A systems analysis of the project is summarized in table 26, and depicted in figure 19.

One of the notable features of the programme was the district level health committees that were established in order to coordinate the various activities of the programme; village health worker training, vaccination and immunization, mother and child health, health and hygiene education, and water and sanitation et cetera. A second feature was the lead role played by the village health workers who were trained in latrine and well construction, and provided with building materials to construct two demonstration latrines in each village, one in her own home and the other at a central point together with a shallow well if the area was suitable. This was later expanded into a national activity. The programme provided a good example of how water and sanitation could be integrated into a broader health programme and the resulting benefits of sharing the resources required for the extension efforts and mobilization of communities (MOH, 1984/87).

15.4 The Save the Children Fund Primary Health Care Project in Binga District Matabeleland North Province

Save the Children Fund (SCF), a well known and well endowed British NGO, became involved in the health sector in Zimbabwe after Independence. They formalized a collaborative agreement with the MOH which effectively empowered SCF to act as an agent of the Ministry in the execution of a primary health care programme in certain specific districts of the country, including Binga in Matabeleland North, one of the most isolated and poorly served districts in Zimbabwe. The programme which was coordinated with the MOH through the District Medical Officer, had a number of components including immunization, mother and child health, and water supply and sanitation.

The water and sanitation component was not particularly successful mainly due to the geology of the area which prevented the use of hand augering and necessitated the construction of deep wells of which SCF had little experience. However, community latrine building was a little more successful and a good participatory programme was established based on the implementation strategy developed by the MOH in the pilot projects. Some 120 latrines and 20 wells were constructed (Boydell & Chingono, 1986b). The programme provided a good model of how an NGO can be used by Government as an intermediary in dealing with communities and the resulting benefits of the flexibility of an NGO working in parallel with the governmental system. A systems analysis of the project is summarized in table 27, and depicted in figure 20.

15.5 Lessons to be Learned from the Projects

The valuable lesson to be learned from the SIDA, DANIDA and Save the Children Fund projects are that all of these projects are representative of the expansion of the RWSS programme from the MOH Pilot Projects to a national programme. Unfortunately, as seen in the SIDA and DANIDA projects, donor pressure to absorb and disburse overly generous funds, counteracts the design and implementation of good projects and can overwhelm Governments capacity. Also seen in these projects was the importance and great difficulty in establishing a maintenance structure for the technologies provided. The SCF project demonstrated the ability of an NGO to establish effective communication with a community and to design and execute a participatory development project, particularly when it acts with Governments endorsement as being an official agent or intermediary. Also seen in both the SCF and SIDA projects was the effectiveness of communications when water and sanitation are linked with health and conversely, that water and sanitation can be used as an effective entry point for a health programme. In contrast, the DANIDA

project clearly underlines the benefits of logical and local level programme planning; the strength of an area based approach and local level planning; and the need to address the maintenance issue.



Table 25.Summary of Systems Analysis of the DANIDA Project1. Systems Present and Their Function

Two donors who supported the project; a community who participated and were beneficiaries; and Government who executed the project.

2. Actors and Their Roles

Donor: The bilateral - DANIDA who supported the project both through Government and a second multilateral donor - UNICEF; and the expatriate advisory team who supported the design and management of the project.

Community: elected and traditional leaders; ward development committees; water/health committees who then operated the well; local builders who constructed the wells and latrines; and womens groups.

Government: MOH and DDF who executed the project; provincial planning team who designed the project; DDF field officers and MOH health inspectors and health assistants who supervised field activities; and village health workers who provided education and promotion.

3. Leaders and Accountability

Donor: The expatriate experts who were accountable to the donor headquarters and the Provincial Government.

Community: Traditional and elected leaders who had limited accountability to the community.

Government: the DDF provincial engineer and the MOH provincial health inspector who were accountable to their ministerial headquarters.

4. Perceptions and Self Interest

Donor: That water scarcity was a major problem and that the donor could support the Government in its provision. That working with and through Provincial Government developing district level plans and operation and maintenance capacity with community groups and using appropriate technology was an effective strategy in doing this. To disburse programme funds and move into the water sector.

Community: To maximize the aid provided by the donor in order to improve their environment and living conditions.

Government: To maximize the aid from the donor in order to be seen in solving the drought problems of the provinces; and in developing integrated district level planning as part of the decentralization movement.

5. Goals and Criteria of Achievement

Donor: number of latrines and wells constructed and functioning properly; district plans completed; budgets used.

Community: continuous water supplies particularly for cattle.

Government: number of latrines and wells constructed; and visible activities of drought relief in the provinces.

Table 25 Continued6. Problem Definition and Solution

Donor: by the expatriate team with Provincial Government.

Community: problems and solutions were not defined internally, however small community groups were assisted in vocalizing their water needs by Government field workers.

Government: by the provincial and district planning teams including the provincial engineer and provincial health inspector.

7. System Interaction and Boundary Spanning

There was substantial interaction between the donor and Government systems as the donor expert team were placed within the central and provincial Government structures. The interaction between the donor Government and the community systems was also substantial at two levels; the contacts being through the Government field workers who met with politicians and small community groups; and through the experts who met with the district planning teams.

8. Commonality and Conflict

The commonality in all the systems was an appreciation of a need for improved water supplies, good local level planning and operations and maintenance. However, conflict arose within the donor system as it was perceived by DANIDA that UNICEF was not operating effectively. Also, conflict arose within the Government system as it was perceived that the donor by operating at provincial level was bypassing the executive role of the central Government ministries.

Other Evaluation Criteria

9. Project objectives clearly defined?.....Yes.
10. Sufficient resources allocated?.....Yes.
11. Any baseline or feasibility studies?.....No.
12. Links established to other sectors?.....Partially to health.
13. Productive capacity improved?.....No.
14. Role of technical assistance and NGOs?.....TA played a major role in the project.
15. Role of Women?.....Emphasized as targets for promotion and maintenance of facilities.
16. Role of private sector?.....Local builders constructed the wells and latrines.
17. Appropriate technology used?.....Yes.
18. Health/Hygiene education provided?.....Yes.
19. Any costs recovered?.....No.
20. Any monitoring and evaluation?.....No.
21. O & M provided for?.....Yes - major project component.
22. Identifiable project phases?.....Yes - planning, institution strengthening and expansion.
23. Any role on effects?.....No.
24. Water sanitation and education integrated? Yes.

Figure 18. Systems Diagram of the DANIDA Project.

Government System

Actors:-

- Ministry of Health
- District Development Fund
- Provincial Government
- The district planning team
- Health assistants.

Donor System

Actors:-

- The bilateral - DANIDA
- UNICEF
- The expatriate advisers

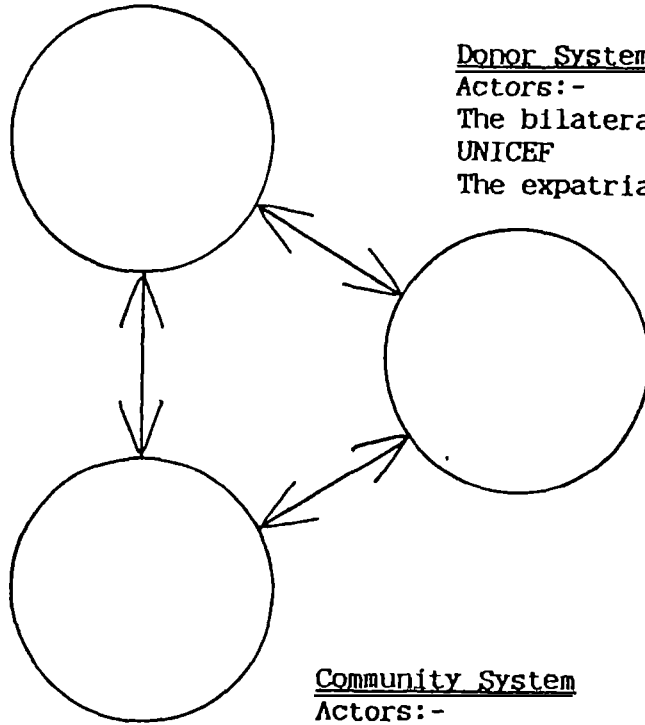

Community System

Actors:-

- Elected leaders
- Traditional leaders
- WARDCOs

Table 26Summary of Systems Analysis of the SIDA Project1. Systems Present and Their Function

A donor who supported the project; a community who participated and were beneficiaries; and Government who executed the project.

2. Actors and Their Roles

Donor: The bilateral - SIDA who supported the project.

Community: Traditional leaders and small community groups with whom agreements were made; water/health committees who then operated the well; local builders who constructed the wells and latrines; and womens groups at MCH and immunization clinics.

Government: MOH who executed the project; Provincial Government and provincial planning team who coordinated the project; health inspectors and health assistants who supervised field activities; and village health workers who provided education and promotion.

3. Leaders and Accountability

Donor: The expatriate programme officers who visited occasionally and were accountable to the donor headquarters.

Community: Traditional and elected leaders who had limited accountability to the community.

Government: the provincial health inspector who was accountable to the ministerial headquarters.

4. Perceptions and Self Interest

Donor: That water scarcity was a major problem and that the donor could support the Government in its provision as part of a primary health care programme. That working with and through Provincial Government with community groups using appropriate technology was an effective strategy in doing this. To expand their programme into the water sector as a means of disbursing funds.

Community: To maximize the aid provided by the donor in order to improve their environment and living conditions.

Government: To maximize the aid from the donor in order to expand the rural water supply and sanitation programme; that water and sanitation are important components of primary health care.

5. Goals and Criteria of Achievement

Donor: Unspecified health improvement; number of latrines and wells constructed and functioning. Budget expended.

Community: Continuous water supplies and provision of latrines.

Government: Unspecified health improvement; number of latrines and wells constructed.

Table 26 Continued6. Problem Definition and Solution

Donor: by consultants who visited occasionally.

Community: problems and solutions were not defined internally, however small community groups were assisted in vocalizing their water needs by Government field workers.

Government: by the provincial planning team and the provincial health inspector.

7. System Interaction and Boundary Spanning

There was little interaction between the donor and Government systems other than in annual programme meetings and occasional visits of experts from the donor HQ. The interaction between the Government and the community system was more substantial the contacts being through the Government field workers who met with politicians and small community groups.

8. Commonality and Conflict

The commonality in all the systems was an appreciation of a need for improved water supplies, and both the donor and Government believed that water and sanitation was an essential component of PHC. However, conflict arose between the donor and Government systems as it was perceived by the donor that Government were not efficient in expending their allocated aid budget.

Other Evaluation Criteria

9. Project objectives clearly defined?.....Yes.
10. Sufficient resources allocated?.....Yes.
11. Any baseline or feasibility studies?.....No.
12. Links established to other sectors?.....Yes - health.
13. Productive capacity improved?.....No.
14. Role of technical assistance and NGOs?.....None.
15. Role of Women?.....Emphasized as targets for promotion.
16. Role of private sector?.....Local builders constructed the wells and latrines.
17. Appropriate technology used?.....Yes.
18. Health/Hygiene education provided?.....Yes.
19. Any costs recovered?.....No.
20. Any monitoring and evaluation?.....No.
21. O & M provided for?.....No.
22. Identifiable project phases?.....No.
23. Any role on effects?.....Yes - the project had impact on subsequent MOH programme designs.
24. Water sanitation and education integrated? Yes.

Figure 19. Systems Diagram of the SIDA Project.

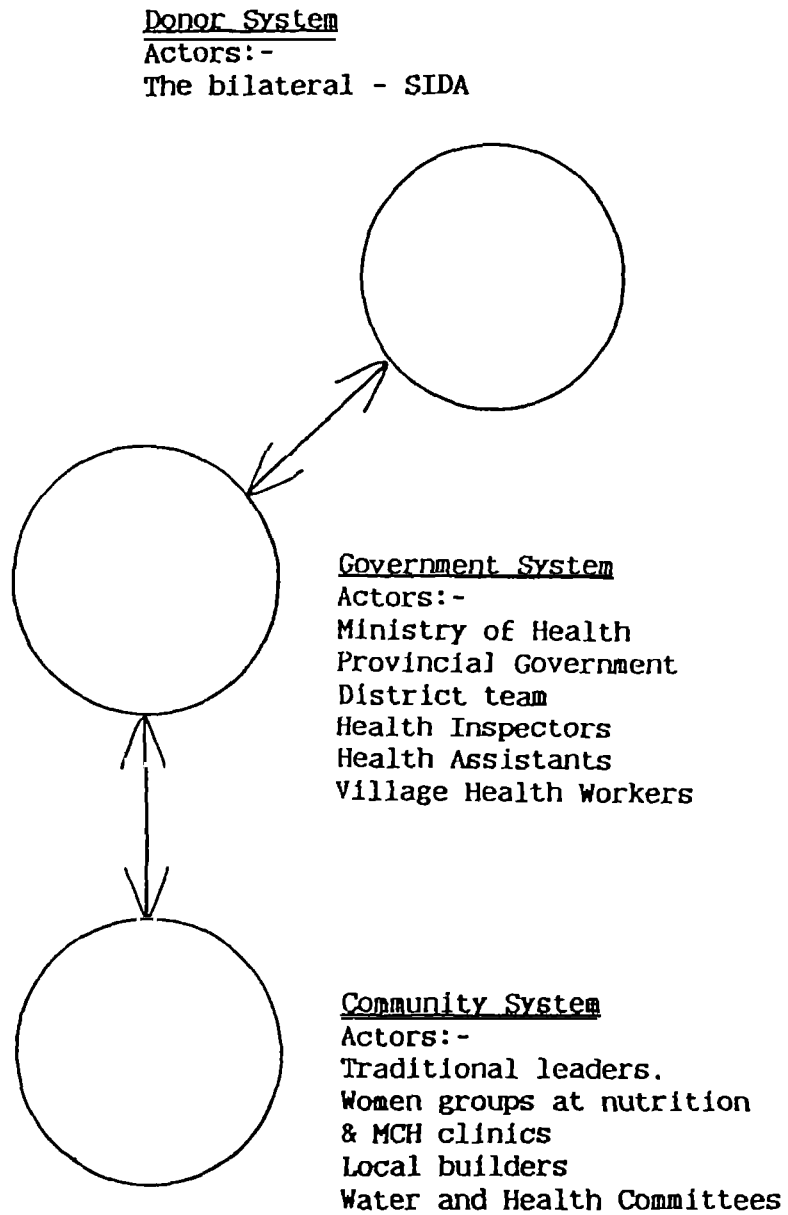

Table 27Summary of Systems Analysis of the SCF Project1. Systems Present and Their Function

A donor who managed the project; a community who participated and were beneficiaries; and Government who played a peripheral advisory role.

2. Actors and Their Roles

Donor: The NGO Save the Children Fund which was the focal point for the project; and the field officer who managed and supervised the project and liaised with district officials.

Community: traditional leaders; womens groups at nutrition and MCH clinics who were targets for promotion; and local builders who built wells and latrines.

Government: Ministry of Health who used SCF as an agent; district health officer who liaised with SCF; health assistants and village health workers who helped in field activities.

3. Leaders and Accountability

Donor: the field supervisor who was accountable to SCF country office and the district health officer.

Community: Traditional leaders who had limited accountability to the community.

Government: the local assistant who was accountable to the district health officer and Provincial Health inspector for the wells and latrines.

4. Perceptions and Self Interest

Donor: That water scarcity was a major health problem and that the NGO could assist Government in its provision. That working with community groups was an effective strategy in solving this.

Community: to maximize the materials loans grant from the donor in order to improve their living conditions in a water scarce area.

Government: lack of resources in the remote Binga area and trust of SCF based on a previous immunization programme.

5. Goals and Criteria of Achievement

Donor: unspecified health improvement; number of wells and latrines constructed.

Community: continuous water supplies.

Government: number of wells and latrines constructed.

6. Problem Definition and Solution

Donor: by the field officer.

Community: problems and solutions were not defined internally.

Government: by the district health officer and health assistant.

Table 27 Continued7. System Interaction and Boundary Spanning

The interaction between the donor and Government systems was on the basis of the personal contact and relationship of the leaders and the district team. The interaction between the donor and community systems was through and in collaboration with Government's extension personnel.

8. Commonality and Conflict

The commonality in all three systems was the appreciation of a need for improved water supplies as a component of a primary health care approach. Major conflict were not seen other than the personal competition for recognition between the Government district health officer and the donor field officer.

Other Evaluation Criteria

9. Project objectives clearly defined?.....No.
10. Sufficient resources allocated?.....No.
11. Any baseline or feasibility studies?.....No.
12. Links established to other sectors?.....Yes - health.
13. Productive capacity improved?.....No.
14. Role of technical assistance and NGOs?.....An NGO was one primary force in the project - acting as a agent of Govnt.
15. Role of Women?.....Not emphasized.
16. Role of private sector?.....Local builders constructed the wells and latrines.
17. Appropriate technology used?.....Yes.
18. Health/Hygiene education provided?.....Yes.
19. Any costs recovered?.....No.
20. Any monitoring and evaluation?.....No.
21. O & M provided for?.....No.
22. Identifiable project phases?.....No.
23. Any role on effects?.....Not directly however SCF provided a model for MOH to work with NGOs.
24. Water sanitation and education integrated? Yes.

Figure 20. Systems Diagram of the SCF Project.

Government System

Actors:-

- Ministry of Health
- District Health Officer
- Health assistants
- Village Health Workers

Donor System

Actors:-

- The NGO - Save the Children Fund
- Field Officer

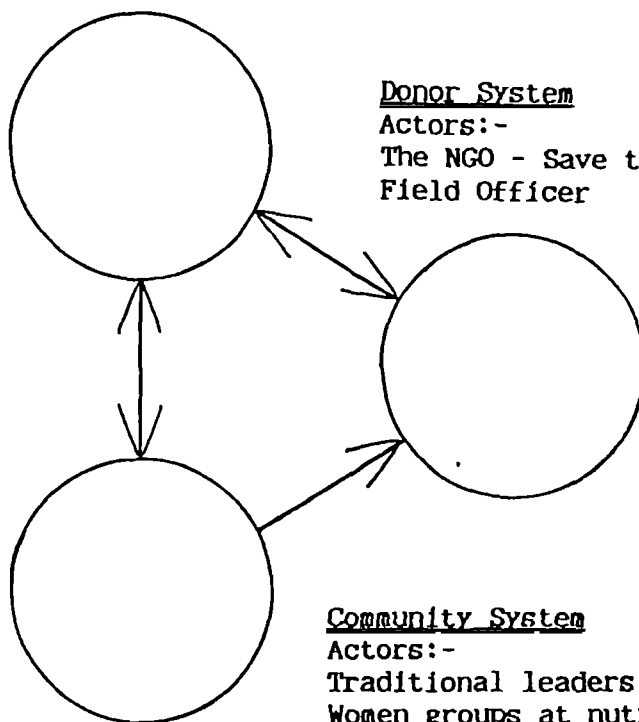

Community System

Actors:-

- Traditional leaders.
- Women groups at nutrition & MCH clinics
- Local builders



- o 0 o -

Chapter 16

Summary of the Case Study Findings

- o 0 o -



Chapter 16

Summary of the Case Study Findings

This chapter summarizes the findings of the project case studies and relates them to the hypothesis set out at the beginning of the thesis. The chapter is structured in three parts. First, a review of the sector development process that took place in Zimbabwe between 1974 and 1987. Second, an analysis of the design and implementation of the various projects that were a part of this process. Third, a review of the respective roles of the three systems involved; donors, Government and the community.

16.1 The Sector Development Process that Took Place

Zimbabwe has made significant progress since Independence in formulating and developing policies and structures conducive to rural development in the Lele model. The land tenure system is being reformed and agricultural production stimulated in parallel with the provision of welfare services. The governmental and administrative system is being decentralized to provincial and district level and the support of agencies such as the NGOs is being absorbed into the institutional fabric by their joining the district development teams. At community level elected bodies, the WARDCOs and VIDCOs are being formed to interface between Government and the communities as a conduit for expressing perceived needs and priorities.

It can be considered that in certain areas Zimbabwe has passed through or is well advanced in the first stage of Lele's model of development. Income and effective demand have been increased to a level at which the rapid expansion of services such as water and sanitation can take place. It is also clear, that since Independence, the rural water and sanitation sector in Zimbabwe has gone through a rapid developmental process that, in terms of the rate of acceleration of service provision, may well be unique in

Africa. This development which commenced well before Independence has been a dynamic process within which number of milestones and factors that facilitated (or constrained) the process can be identified.

The process started in the early 1970's with two small NGO projects; St. Theresa's in Chilimanzi and the the CSSD project in Mashonaland (one a health based project, the other based on agriculture), in which the donor agencies were trying to directly redress the poor levels of services in the tribal areas through stimulating the local communities cooperative efforts (see Chapters 8 and 9). These projects became de facto pilot projects or proving grounds where a community based implementation strategy was developed and tested. In parallel with this, the Ministry of Health's Blair Research Laboratory of the then Rhodesian Government was developing low cost and appropriate latrine and handpump designs that were intended for use in commercial farm compounds and tribal trust lands as a means of controlling schistosomiasis. They were also later used in the protected villages and internment camps established during the liberation struggle. The Chilimanzi project was used extensively for field trials of both the Blair pump and latrine. Therefore, at the time of Independence, the Zimbabwean Government had to hand an implementation strategy, albeit imperfect, and designs for low cost hand pumps and latrines that were seen as a local product with which the MOH's extension staff identified. Furthermore, the protracted technology debate that seems to constrain sector development in other countries had been avoided.

Post Independence, Government through the MOH in its drive to establish a rural primary health care programme launched three pilot projects in Mhondoro, Serima and Zimutu communal areas in which substantial water, sanitation and education components had been integrated. The delivery strategy for these drew from the experiences of the earlier NGO pilot projects, and incorporated the Blair Latrine and pump. The water and sanitation components rapidly expanded and overwhelmed the other components of

the projects. In effect three large water and sanitation demonstration projects had evolved in which the strategies developed in the donor/NGO pilot projects were further refined and modified. These de facto demonstration projects had a fundamental impact on the future development of the sector (see Chapter 10).

The Independence of Zimbabwe coincided with the launch of the IDWSSD which was seen by the new administration as a vehicle for assisting in the transfer of resources to the rural areas. A Decade National Action Committee (and sub committees) were formed which provided a good and active forum for exploring interministerial cooperation or liaison and undertaking practical tasks such as making an inventory of the sector and the development of training materials. This marked the beginning of strong political commitment, and the beginnings of improving interministerial communications within the Government system (see Chapter 5).

Following the Zimcord Pledging, and in response to the promotion of IDWSSD, Zimbabwe became a country of focus for a number of new donors willing to support the improvement of rural water supply and sanitation in both reconstruction and development projects. This marked a substantial influx of funds, and technical assistance, which led to a rapid expansion of the water and sanitation programme throughout the whole country. This range of external support agencies which included multilaterals, bilaterals and NGOs, brought with them a range of preconceived developmental philosophies and approaches. The best of which were flexible enough to adopt and improve upon the implementation strategies that had been evolving in Zimbabwe for the previous ten years or so, and absorb them into a broader development effort. A number of these donors funded and/or executed projects which became additional de facto pilot projects in other provinces. These replicated the MOH implementation strategy and thereby widened the range of the demonstration effect. Other bilateral donors integrated RWSS components into

their health or agriculture projects. By contrast, other donors and NGOs because of their preconceptions and professional biases, imported new strategies and technologies or worked in isolation of the governmental structure. The national rural water supply and sanitation programme had become a complex matrix of various projects, with differing approaches and underlying philosophies executed and/or funded by an array of external, local and governmental agencies.

A further milestone in the development of the sector was the preparation of the National Master Plan for Rural Water Supply and Sanitation. The bilateral donor NORAD, having made a policy commitment to fund sector development in Zimbabwe, decided that the most logical way to embark on this was to commission the preparation of a NMPRWSS using expatriate experts provided through a consulting company (see Chapter 6). NORAD invested some Z\$20 million in providing some 250 man months of Norwegian technical assistance which produced an eighteen volume tome that has still to be accepted by Government. The NMPRWSS was a conventional engineering study that equated existing service deficits and population growth with the need for future investments over the next twenty years. This served the donors own internal needs to justify its sector support. However, the plan which adopted a vertical single sector approach failed to respond to the development needs of the sector or the rural areas. Furthermore, the plan did not build upon the experiences gained in the pilot or demonstration projects, nor did it examine the successes of other donors or embody the decentralized integrated rural development policy of Government. The plan which proposed radical institution reform as precedent for future investments was found by Government to be confrontational, controversial and politically impossible to implement. This, combined with the donors later diversion of the energies of the IDWSSD NAC into exclusively supporting the disbursement of the NORAD long term programme funds, has probably inhibited more recent sector development.

The rural water supply and sanitation sector development process that took place in Zimbabwe can be summarized as follows. First, the establishing of small pilot projects in which implementation strategy were developed by a donor. Second, the establishing of larger demonstration projects in which the implementation strategies were refined and tested on a large scale by Government. Third, the establishing of political support and commitment and the start of the interministerial debate. Fourth, the influx of funding and technical assistance from donors, the expansion of the demonstration areas to all provinces, and fifth, the expansion in scale to a national programme and the absorption of water and sanitation into other broad development projects.

The following factors were significant in enabling the development of the sector. The "technology choice" question was resolved and long debate avoided because of the applied research carried out locally by the Blair Laboratory. The long standing presence of two NGOs who were able to start developing a strategy of community involvement even before Independence. Increased momentum was created by the coincidence of the start of the IDWSSD and Zimbabwe's Independence. The availability of flexible funding for the development of the demonstration projects. The availability of a cadre of extension workers, that is, health assistants, who identified themselves with the technology and the programme. The relatively high level of economic development in the country, albeit polarized.

The rural water supply and sanitation sector development process that has taken place in Zimbabwe validates the hypothesis that sector development is a dynamic process that passes through a series of identifiable stages which may be termed pilot, demonstration and expansion to national programme phases. Also, it is apparent that the time scale of the process from the early pilot projects to the start of the expansion into a national programme is long, approximately fifteen years in the case of Zimbabwe, and therefore well beyond

the length of the Water Decade. Furthermore, it is also apparent that pilot and demonstration activities had to exist effectively as free standing projects until political commitment, and a general acceptance had been established. After that time the projects were slowly being absorbed into broad and rapidly expanding rural development process as described in Lele's model.

16.2 The Design and Implementation of the Case Study Projects.

Table 28 summarizes the evaluative criteria applied to each case study. It was found that each of the criteria was relevant to the analysis and provided a good basis for cross project comparisons, particularly as all the projects were theoretically community based, used appropriate technology and integrated water with sanitation and health education. Questions such as "was an effective maintenance system established?" to which clear cut answers could be given, were of particular value in measuring the effectiveness and comparing projects. However, questions such as "was the community involved?" to which only conditional and subjective answers could be given posed some difficulty in making the comparisons. Table 29 shows the mix of components in each project case study. Of the ten projects analysed, the majority attempted to integrate water supply, sanitation and health education. The majority were also led by dynamic leaders and attempted to involve the community. However, less than one third of the projects specifically focused on women. More than half of the projects had some degree of local level planning and institution building, and all involved the private sector through the training of local builders and miners. Credit, cost recovery and improving the productive capacity of the community was a feature of only one project and effective monitoring and evaluation was not established in any. Effective operations and maintenance was established in less than one third of the projects. A number of

Table 28
Summary of Evaluative Criteria for Each Case Study

	St. Therasas	CSSD Project	MOH Pilots	GTZ Masvingo	UNICEF Wells	LWF Wells	NORAD C & LT	DANIDA Mid & Mat	SIDA Manic'd	SCF Binga
Systems Present	DC	DC	DGC	DGC	DGC	DC	DG	DGC	DGC	DGC
Objectives well defined	0	0	1/2	X	0	X	X	X	X	0
Logical project design	0	0	1/2	X	0	X	X	X	X	0
Suffict resources provided	0	0	1/2	X	0	X	X	X	X	0
Baseline & feasib studies done	0	0	X	X	0	0	1/2	0	0	0
Intersector links established	X	X	X	X	0	X	0	1/2	X	X
Productive capacity improved	0	X	0	1/2	0	1/2	0	0	0	0
Tech asst provided	0	0	0	X	X	X	X	X	0	X
NGO involved	X	X	0	0	X	X	0	0	0	X
Women involved	X	X	0	X	0	0	0	X	0	0
Private sector involved	X	X	X	X	X	X	1/2	X	X	1/2
Appropriate technology used	X	X	X	X	X	X	1/2	X	X	X
Integrat water san & health education	X	X	X	X	0	0	1/2	1/2	X	X
Costs recovered	0	X	0	0	0	0	0	0	0	0
Monitoring & eval established	0	1/2	1/2	1/2	1/2	0	0	0	0	1/2
D&M established	0	0	0	1/2	X	X	0	X	0	0
Project phased	X	X	X	X	X	X	X	X	0	0
Role on effects	X	X	X	X	X	0	0	X	0	0

Key: X - yes, 0 - no, 1/2 - partially.

Table 29
Mix of Components in Each Project

	St. Theresas	CSSD Project	MOH Pilots	GTZ Masvingo	UNICEF Wells	LWF Wells	NORAD C & LT	DANIDA Mid & Mat	SIDA Manic'd	SCF Binga
Water Supply	X	X	X	X	X	X	X	X	X	X
Sanitation	1/2	X	X	X	0	0	1/2	X	X	1/2
Health/Hygiene Ed	X	X	X	X	0	0	1/2	1/2	X	X
Dynamic Leadership	X	X	X	X	X	X	0	0	X	1/2
Local Level Planning	X	X	1/2	X	0	0	0	X	X	X
Institution Building	0	0	X	X	X	0	X	X	X	X
Community Participation	X	X	X	X	1/2	1/2	1/2	X	X	X
Women Specifically Involved	X	X	0	X	0	0	0	X	0	0
Builder Training	X	X	X	X	X	X	1/2	X	X	1/2
Credit & Cost Recovery	0	X	0	0	0	0	0	0	0	0
Maintenance	0	0	0	1/2	X	X	0	X	0	0
Monitoring & eval/ impact surveys	0	1/2	1/2	1/2	1/2	0	0	0	0	1/2

Key: X - included, 0 - not included, 1/2 - partially included.

significant design issues are discussed in detail below.

a) The General Design Approach

Few of the projects can be considered to be well designed in that, their overall developmental objectives were not well defined, and of the few projects that had originally established goals or targets almost none managed to achieve them. This was due mainly to over optimistic targets, and also because the relationship between proposed inputs and expected outputs had not been logically correlated when the projects were being designed. An exception to this is, perhaps, the GTZ project which was designed using the "logical framework" planning technique (see Chapter 11). All the projects exceeded their planned time scales, which confirms that community based programmes are slow in starting, and need a long lead time before wide implementation occurs. Without exception, all the project designers who set targets had grossly under estimated this.

A further concern raised by looking at the overall project designs, is that little consideration was given in most, to establishing maintenance systems in order to ensure the sustainability of the facilities being provided. Indeed, the provision of new facilities was the main thrust in all the projects, with the exception of the DANIDA funded activity which had a substantial rehabilitation and maintenance component (see Chapter 15). It is ironic that donors in general, are not willing to provide funds to cover Governments recurrent costs. They provide capital funds to create structures requiring maintenance without providing for the establishment of mechanisms in the project designs to cover these costs. It was also apparent that as the national programme evolved the number of donors and volume of aid funds overwhelmed Government's absorption capacity in both planning and implementation, which then created conflict and distrust between the Government and the donor. Other concerns in a number of projects were; the lack of a real understanding of the community structure and priorities by the project designer; the lack of systematic

monitoring and evaluation; and the limited focus on women as a target group.

The common theme running through all the projects was the attempt to integrate water, sanitation and health education, and to involve communities. However, it is apparent the the centrally designed, free standing RWSS projects were less successful than the projects that had been designed with local level involvement, and that had established links with the agriculture and health sectors, for example, the CSSD and MOH pilot projects. All the project designers claimed that their projects included components for involving women, monitoring and evaluation, local level planning, local training, operations and maintenance et cetera. However, few project managers indicated how these components could be brought together in an effective programme. However, the most successful projects were those in which a dedicated leader turned these ideals into reality.

In contradiction to the Lele model of sequenced improvement of productive capacity, and provision of welfare services, it was found that only two projects were preceded by or had income generating activities, the CSSD and GTZ projects. In fact, it was felt by many that the water and sanitation intervention, because it was a felt need, was the entry point for rural development rather than a consequence of it. However, Lele's thesis of simple projects designed to remove critical constraints certainly remains valid. The case studies also demonstrate the difficulties in linking domestic water provision with agriculture, for example the small gardens in the LWF wells project which fell by the wayside during project implementation.

b) Involvement of the Private Sector

Apart from the NGOs who are considered by some to be within the private sector, there are a number of examples of how private sector interests were mobilized and involved in the development of the sector. These ranged from the

direct improvement of the skills base of local artisans to the indirect involvements such as pump and pipe manufacturing and drilling of boreholes by contractors. These activities which often had considerable spin off employment generation effects have included for example. The training of private well sinkers in the UNICEF and LWF well sinking programmes. The training of masons for latrine building in the MOH and GTZ sanitation projects. The promotion and development of local manufacturing capacity for handpumps by the LWF, MOH and MEWRD.

One potential avenue of privatization that was not fully explored was that of the maintenance of handpumps. Although some attempt was made to train local pump mechanics (by LWF, UNICEF and DDF), it was assumed that they would be paid and absorbed into the Governmental structure. The potential for a truly private pump maintenance system is clearly worthy of further investigation particularly if the preconception that Government has to be fundamentally involved can be removed.

c) Credit, Finance and Cost Recovery

It is interesting to note that the only project with a substantial credit and cost recovery component was the early donor/NGO pilot project managed by CSSD in Mashonaland (see Chapter 9). Yet it was the one component that was dropped from the evolving implementation strategy, and although the cost recovery rates were poor, the revolving fund model developed by CSSD seemed to have some good potential. Clearly the issue of cost recovery had major political implications for the post Independence Government and in turn the bilaterally funded projects.

d) The Involvement of Women

The projects which focussed their promotional and educational strategies at women had a greater degree of success than those which did not. This was the case in the GTZ programme in Masvingo and the CSSD project in Mashonaland. However, it was detected in a number of

projects that the males resented their seeming isolation from the planning process.

e) Local Level Planning

Another critical factor seen in the more successful projects was the involvement of local level authorities in the planning process. In general this involved having the District Administrator bringing together his District Development Team (which comprised of local representatives of the Ministries of Health, Agriculture, Local Government, DDF, Womens Affairs) and representatives of the communities, that is the local councillors. Within the constraints of budget and donor guidelines, this group prepared a project draft which was reviewed by provincial and national level authorities in an iterative process of refinement. This can best be seen in the DANIDA funded project in Midlands and Matabeleland which focussed on strengthen district level planning capacity (see Chapter 15) and the GTZ funded project in Gutu District (see Chapter 11). Within this local level planning process a second level of iteration took place; between the councillors and the community. this information was fed back into the higher level debate. It is also important to note that at the District Team level a high degree of interministerial cooperation took place and that a number of NGOs were also involved or absorbed into their activities. This was the case with CSSD in Mashonaland and Save the Children Fund in Binga (see Chapters 9 and 15).

f) Links to Other Sectors

Links to other sectors can best be seen in three projects; the linkage to health sector in the SIDA funded project in Manicaland and to the agriculture sector in the GTZ funded project in Masvingo and the CSSD project in Mashonaland. The linkage to health seems to be the most logical particularly as the project was executed by the MOH who strongly believed in the integration of water supply, sanitation and health education. Indeed the benefits of

combining the communications and educational needs of primary health care and community based water and sanitation programmes are fairly obvious. However, the potential benefits of linking water and sanitation to agriculture development are also great as seen in Mashonaland where agricultural cooperatives were used as the focal point for the water and sanitation project, and in Masvingo where the water supply and sanitation demonstration project was one of the precursor to, and an important component of, a broad agriculture based integrated rural development project.

g) The Choice of Technology

The choice of technologies within most of the projects was standardized and restricted to the Blair Latrine, the Blair Pumps fitted to shallow wells, and the Bush Pump fitted to deep boreholes and hand dug wells. The LWF was the only donor that introduced a non locally developed technology. The history of appropriate technology development, which originated well before Independence, was stimulated by the economic isolation imposed by the sanctions of the 1960's and 1970's following Rhodesia's Unilateral Declaration of Independence. This led to the post colonial state inheriting a a few locally developed robust technologies that have to a great extent been institutionalized in the water sector. The great technology debate, regarding which type of pump or latrine to use, that rages in other developing countries, often led by the donors, does not exist or has been dissipated in Zimbabwe because of the efforts of the Government system. Furthermore, the technologies have become standardized and familiar to both extension staff and the communities themselves. This has allowed more energy to be directed into other aspects of the sector, particularly the development of appropriate implementation strategies (see chapter 5). It is also worthwhile noting, that the potential for community participation and involvement is much greater in the hand dug wells projects as compared

with the borehole programmes. This may be an obvious point, but is an important consideration when designing a project.

h) Operations and Maintenance

None of the projects developed a sound operations and maintenance facility or structure either within the project or within a governmental structure. In general maintenance was undertaken on an ad hoc basis by the project implementing agencies. However, a number of projects tried to address this issue in a variety of ways. UNICEF and LWF established pilot maintenance schemes, based on a three tier system with Government at the top. In contrast, in St. Theresa's Mission project the NGO assumed direct responsibility for all maintenance. Not a single project tried the direct expedient of divorcing Government from the maintenance burden by handing the responsibilities directly to the communities themselves.

i) Leadership

One of the main factors noted in the successes of the projects is the dedication of a single individual who drove the projects to successful conclusions, despite the inadequacies of the project design. Dianna Auret in the CSSD project, Sister Pat Walsh in the St. Theresa's Mission Project, David Proudfoot in Masvingo and David Williams in the UNICEF wells project are excellent illustrations. However, few projects recognized this and training for succession in leadership was not a feature in any project.

16.3 The Roles of Donors, Government and the Community.

The strength of the case studies is that trends can be seen in the data. Table 30 shows the role of the systems in each project, and table 31 summarizes the rural water supply and sanitation supra system. as it existed in Zimbabwe. As can be seen the donor system played a major role in the direct planning, funding and implementation of projects. Whereas, much less emphasis was given to training

Table 30
The Role of the Systems in Each Project

	St. Therasas	CSSD Project	MOH Pilots	GTZ Masvingo	UNICEF Wells	LWF Wells	NORAD C & LT	DANIDA Mid & Mat	SIDA Manic'd	SCF Binga
DONOR										
Type; multi, bi, or NGO	NGO	NGO	NGO/multi	bi	multi	NGO	bi	bi	bi	NGO
Funding	X	X	1/2	X	1/2	X	X	X	X	X
Planning	X	X	0	X	X	X	X	1/2	1/2	X
Implementing	X	X	0	0	0	X	X	0	0	X
Expatriate TA for management	X	X	0	1/2	X	X	X	0	0	X
TA for training Government	0	0	0	X	1/2	0	1/2	X	X	0
GOVERNMENT										
Funding	0	0	1/2	0	1/2	0	0	0	0	0
Planning & policy	0	0	X	X	X	0	1/2	1/2	X	X
Implementing	0	0	X	X	X	0	1/2	X	X	1/2
Local planning	X	X	1/2	X	0	0	1/2	X	X	X
Coordination	0	0	X	X	X	0	0	X	X	1/2
Extension	0	0	X	X	1/2	0	1/2	X	X	X
NGO intermediary	0	0	1/2	0	1/2	0	0	0	0	X
COMMUNITY										
Planning	X	X	1/2	0	0	0	0	1/2	0	0
Construction	X	X	X	X	1/2	1/2	1/2	X	X	X
Managing project	0	X	0	0	0	0	0	0	0	0
O & M	0	0	0	1/2	X	X	0	X	0	0

Key: X - involved, 0 - not involved, 1/2 - partially involved.

Table 31. Summary of the Rural Water Supply and Sanitation Sector Supra System as it Existed in Zimbabwe.

1. Goal and Objective

Improved health through the provision of improved water, sanitation and education as part of primary health care and rural development in communal and resettlement areas.

2. Inputs, Outputs and Transformation Process

Finance and expertise which is provided by the donors is transformed into water and sanitation infrastructure through a process of designing and implementing projects and programmes, to which Government and communities have varying degrees of input. Some projects are illogically designed such that the outputs cannot be achieved with the given inputs

3. The Systems and Their Functions

a) Donors are planners, funders and implementors. A number of donors, including NGOs, provide financial and technical resources to Government or directly to the community primarily for the construction of new schemes. Less attention is paid to training and institutional strengthening. Coordination is poor and some overlap does occur resulting in less than optimum use of resources. Donors have not encouraged Government to develop sound fiscal policies and sectoral priorities that are removed from political interference. Some donors have also introduced project elements such as alternative technologies and delivery mechanisms which conflict with those developed locally.

d) Government is a policy maker, planner and implementor. It has established a rural development policy, and theoretically coordinates donor support. It is also attempting to create an environment conducive to development by strengthening local level planning and implementation capacity. This includes motivating and mobilizing communities into self help efforts by providing technical, financial and educational support through an extension network. However, Government comprises of many interested institutions which are poorly coordinated.

c) Communities are mainly passive recipients. Their participation in water and sanitation project mainly through providing labour and materials. Their involvement in planning, managing and maintaining the systems is limited.

4. Some Key Actors and Their Roles

a) Donor experts and consultants mainly concentrate on project planning and implementation.

b) NGOs are mainly involved in direct project implementation. However, a few are used by Government to supplement extension workers as intermediary in their communications with communities.

c) The domestic private sector which is a largely untapped resource, is mainly involved through the use of local builders who construct wells and latrines.

d) Women because of their role as the carriers of water and guardians of family health are the major focus of mobilization and education campaigns.

e) Politicians and local community leaders use the promise of the provision of free water for political gain.

- f) Government officers who are involved in project design, implementation, and donor liaison, but are reluctant to coordinate their activities.
- g) Project leaders who drive projects along to successful conclusion despite the short coming of the original design.

5. Main Characteristics of the Projects

- a) Projects in the main do not provide a balance between providing for basic needs at community level and institution building.
- b) Communities mainly participate by providing labour and materials.
- c) Projects are mainly free standing, centrally designed and not set in a broad rural development context. However, some are coordinated with activities in other sectors such as health and agriculture.
- d) Costs are mainly borne by the donors and Government.
- e) The rural water supply programme has evolved adaptively from small projects.
- f) Projects attempt to integrate water, sanitation and education components and are based on appropriate technology.
- g) Projects are not systematically monitored and evaluated in order to feed the evolution process.
- h) The principles of replicability and sustainability are not strictly adhered to. Most projects could not be replicated nationally, or sustained by the community.
- i) A full understanding of the structure, needs and priorities of the community groups is not usually developed before embarking on a project design or implementation.
- j) The importance of dynamic leadership is clear. However, projects do not include for leadership succession training.

6. The Supra Systems Dynamic

Sector development has progressed from small scale pilot activities to large scale programmes in an adaptive learning process during which the function of the systems, and role of the actors has changed over a time period which approaches 15 years. However, towards the end of this process, the influx of new actors with their own biases, perceptions and self interest, particularly in the donor system, has threatened to disrupt the learning curve.

and institution building. Government's role was wide ranging and less well defined. Extension, planning, policy formulation, coordination and implementation using external resources are amongst the major activities. However, using NGOs as intermediaries is not a strategy widely adopted by Government. The clearly perceived role for the community is to provide labour for construction and to take up the maintenance responsibility after completion of the project.

a) The Effect of Donor Policy and Attitudes

The donors or external support agencies can be considered in two categories, firstly the NGOs and secondly the multilateral and bilateral donors. In general terms the NGO projects were found to be the most responsive to the needs of people or communities and had the flexibility to be implemented relatively efficiently at the local level. They do not appear to have had any long term impact on policy or the institutional capacity of Government. However, they were a fundamental part of the process that led to the definition of future programme implementation strategy. Whilst, the bilaterally and multilaterally supported projects were generally less responsive to community needs, being managed through central ministries or institutions, they also tended to be single sector projects that rarely explored linkages to other activities. However, they did attempt to formulate or modify Governments policies and increase its capacity to implement similar projects in the longer term. However, there are some notable exceptions to the above that are discussed below.

The NGO's reviewed can be categorized as those existing in Zimbabwe before Independence or those who came later. St. Theresa's Mission is typical of the older pre Independence NGOs, which were often sponsored by a religious order and had a long term commitment to a specific community within which they have existed for a number of years and had established a relationship based on trust and respect. This trust relationship formed the basis

for being able to discuss and develop the pilot project implementation strategy which was contingent on both parties in the process fulfilling certain obligations. In comparison the new or post Independence NGOs are similar to bilateral donors in that they are driven by the need to satisfy targets of output and disbursement yet they are not constrained by bilateral agreements. This has both advantages and disadvantages. The Lutheran World Federation has established what amounts to an alternative structure to Government for the provision of water supplies that has had little institution building effects. In comparison the Save Children Fund by working closely with the MOH have provided a bridge between Government and the community.

A wide range of philosophies, professional biases and hence approaches can also be seen in the bilateral donors often based on their experiences elsewhere. However, technical assistance is common to most donor programmes. GTZ are committed to integrated rural development, based on agriculture, and the strengthening of local level planning and implementation capacity using a low key, local level, technical assistance approach. This can be confirmed from their projects in neighbouring Zambia and Tanzania (GTZ, 1984/87). SIDA promoted an integrated approach to primary health care through existing governmental structures. DANIDA, as in their sector project in Tanzania, strongly promoted the production of district development plans, local coordination committees and rehabilitation of existing hand pumps and the establishment of a maintenance system (DANIDA, 1984/87). Whereas, NORAD, who are typical of many bilateral donors promoted a single sector activity through central Government, driven by expatriate consultants and technical assistance personnel, which replicates their earlier programmes in Zambia and Tanzania (NORAD, 1984/87). However, a common factor of all the bilateral donors is the intense pressure they put upon Government ministries or authorities to disburse development funds allocated to them. This would seem to indicate that funds were over allocated in the first instance or that the absorption

capacity of Government had been grossly over estimated.

Of the multilateral donors, it is interesting to compare the UNICEF wells project with that of the LWF. UNICEF worked within the governmental system to build future implementation capacity whereas the LWF worked outside the system to serve community needs. The EEC Micro Project Fund used to support the MOH's Mhondoro Pilot project would appear to be an almost ideal funding mechanism being readily available without protracted negotiations, flexible and free of time constraints. The War on Want NGO funding of the Serima pilot project was effectively the same.

b) The Role of Government

The role of Government in the projects ranged from direct management of implementation, to no involvement at all, see table 30. For example, compare the MOH pilot projects to the Lutheran well sinking programme. Both of these extremes had advantages and disadvantages. In the MOH pilot projects Government developed a good project model and strategy within a broad rural development and primary health care framework, but during the implementation became bogged down in the bureaucracy of procuring materials, managing vehicles and staff et cetera (Skitt, 1985). By contrast, the Lutheran programme was efficiently managed, but in effect was competing with Government rather than supporting the development process. Clearly Government must oversee and maintain an interest in the direction and design of projects, but it is not well equipped, despite its extension workers, nor does it have the flexibility of operations to respond to the implementation demands of a community based programme, a model for which is provided in the NGO projects. The project of greatest interest in this respect is Save the Children Fund project in Binga District. SCF formalized a collaborative agreement with Government which empowered them to act as an agent of Government in the implementation of a primary health care programme. The project which was coordinated at district

level provides a good model for an NGO being used by a Government as an intermediary in dealing with the community system.

Lack of interministerial coordination, one of the main constraint to sector development in Zimbabwe, first identified in the World Bank Sector Study (Vogel et al, 1980), is an issue that can be seen at national and project level. At the national level this inability for government bodies to share information and jointly plan programmes was to a large extent responsible for the shortcomings of the NMPRWSS. The original terms of reference for the study were not jointly prepared by the various sector ministries, and the master plans interministerial steering committee was only attended by junior officials who could not represent their ministries plans or policies. Whereas, senior staff avoided the meetings. This indicates the degree of sectoral isolation created by the senior professionals or technocrats in Government, which leads to the design of vertical single sector projects. At project level poor coordination took a number of forms ranging from the overlapping activities of extension workers to the exclusion of NGO projects from district level development plans.

c) The Role of the Community, Communications and the Extension Worker

The range of activities referred to as community participation in the projects was wide, see table 30. Clearly the more successful projects were those in which community participation was a reality starting at the initial planning phase. The projects that paid lip service to the concept did not reap the same level of potential benefits. For example, in the NORAD crash borehole drilling project the community were involved in choosing the site of the borehole, and in completing the well headworks. However, in reality, the boreholes were often drilled at the most convenient place for the heavy drilling rigs which had difficulty in manoeuvring off surfaced roads. Hence

the community rapport was disrupted, and problems were experienced in completing the headworks. In comparison, in the St. Theresa's Mission project a dialogue was established with the community before the project began that shaped the implementation strategy and agreed the inputs and responsibilities of the participating groups. This dialogue had a positive impact on the projects execution. Examples of good communications are also seen in the GTZ project in which training materials and curricula were developed for the training of builders and pump minders. Three of the main constraints to community participation, and good communications are. First, lack of a good understanding by the donor or government of the community structure and priorities, the community is a label often used to generalize a complex system. Second, the lack of cohesion in the structure of the communities themselves, and third the ineffective role of the extension worker who are the systems boundary spanners. The extension workers should provide a catalyst for community action and a conduit for information. However, this is undermined by a number of factors including overlapping and unclear responsibilities and duties. Lack of status in the community, and conflicts caused by favouritism in appointments. Lack of direction and supervision, together with inadequate training and preparation. Overlapping roles was particularly apparent in the conflict between the MOH and MCDWA cadres.

- o 0 o -

Chapter 17

Conclusions and Recommendations

- o 0 o -



Chapter 17

Conclusions and Recommendations

This chapter concludes this thesis by reviewing the reasons for the poor performance of the IDWSSD in light of the experiences in Zimbabwe. It proposes a model for rural water supply sector development, and project design, which makes specific recommendations on the potential roles of the three systems involved; developing country governments, donors and communities in this process. Finally, it comments on the future role for water master planning; the need for further research in the sector; and the usefulness of systems analysis in this study.

17.1 General Comments

The writing of this thesis was prompted by two factors. First, a dissatisfaction with the plethora of crude explanations given by the UN, WHO and others for the failure of the IDWSSD to achieve the goal of water and sanitation for all by 1990. Second, by the authors own personal interest in the design and implementation of rural water supply and sanitation sector development projects, and concern about the approach to project design promoted by some donors and adopted by some Third World countries.

It is strongly recommended that at the high levels of international debate regarding foreign aid, that the IDWSSD should be viewed as a major management exercise that involves two main actors, the international donors and recipient developing country governments, and the reasons for the failure of the IDWSSD to achieve the goals set in 1980, should be the subject of a much more rigorous and systematic scrutiny of both parties regarding their roles and relationship. At the project level the number of parties to be scrutinized increases to three; donors, governments and communities themselves. The design and

implementation of projects also requires careful scrutiny, as it is effected by the higher level donor - recipient relationship, but is also subject to other constraints related to the behaviour of the various interest groups involved.

It has been demonstrated that the IDWSSD is a product of the changes in development philosophy since the World War II. It reflects a move towards appropriate technology and basic needs (particularly primary health care), that necessitates the need for involving the recipient communities in decisions regarding the planning, construction and operations of schemes and the decentralization of planning and administrative structures in order to accommodate and support this. Hence the IDWSSD defines a new role for governments, donors and people in project design and implementation that demands much greater flexibility, coordination and cooperation. Although some donors and governments have sought to develop innovative project implementation strategies, many pay lip service to these ideals and in practice the traditional donor, government and community roles and relationships are maintained. The constraints to change lie within all the different bodies involved and at various levels.

Without doubt the IDWSSD has had tremendous impact on bringing international attention to the needs of the sector, but the concept of a very narrow and specific sectoral focus and its single-minded promotion by the donor community, particularly the multilateral donors, has a negative aspect. The single-mindedness is reflected in the approach that many donors and governments have taken while designing projects and programmes at country level. This has led to the creation of vertical programmes that often ignore the potentially beneficial horizontal links to other sectors particularly agriculture and health, and that are not seen as a component of broader rural or urban development plans. This has been reinforced by the narrow research emphasis on individual project components such as the appropriate design of pit latrines or hygiene education

training materials. However, the relationship between water and the development process has been largely ignored by researchers. Perhaps the development of the IDWSSD should reflect the sector development model described later. Having now gone through the pilot and demonstration phases, it is now time to expand research and implementation activities horizontally in order to ensure that "Water Decade" activities are absorbed into a broader developmental process.

Individual donors have their own particular biases and philosophies; political, economic and social which they try to promote within their aid programmes through their technical assistance personnel. Furthermore, the managers of donor agencies, particularly the bilateral are under pressures to spend their allocations, and to be seen as doing a "good job" both domestically and in the recipient country, this fosters tendencies to rely on technical assistance personnel who are seen as trust worthy and predictable, and the design of large intensive projects in which funds are disbursed rapidly with little regard to longer term financial and physical sustainability and which often overwhelm the limited capacity of the recipient. The technical assistance personnel themselves are often drawn from professions or sectors which ill equip them to understand complex developmental issues and problems, and they often bring with them an entrenched professionalism which dictates a behaviour that often precludes cross sectoral and cross professional coordination, and hence the development of integrated projects and the use of non professional intermediaries such as NGOs is restricted. Whereas, other development agencies particularly the NGOs are more concerned with aiding the welfare of individual community groups and often fail to relate their activities to a broader development process or the building of capacity of a developing county government to take over this responsibility in the longer term.

Developing country governments often do not share the same philosophies and priorities as the donors and they may

accept a specific sector aid programme because of the donors leverage or as precondition for other assistance. This leads to lack of real commitment and efforts in some sectors. The developing country institutions also suffer from professionalism and sectoralism which leads to overlapping responsibility, poor coordination and planning, vertical projects, a resistance to institutional reform and a rejection of other agencies such as NGOs who are seen as amateurs. It also leads to the covering up of limited capacity and a reluctance to seek assistance from agencies such as NGOs. All this is often reinforced and compounded by the professionalism and sectoralism of the technical assistance provided by the donor. The development of the NMPRWSS and the NORAD crash borehole drilling programme is a good example of all of these.

The perception of the target group, that is, the community and their needs is often distorted by both donors and governments and the communities social structure is often not clearly understood. Communities are not cohesive groups of people striving for a common good, but a complex hierarchy of internal and external relationships and conflicts governed by favouritism, jealousy and other emotions. Often the community's priorities are different to those perceived by the external development agency, and some governments may have a tendency to over burden a community with self help projects that clash with agricultural cycles and are of lower priority than other community perceived needs. This is one of the contributory factors to the slow implementation of the resettlements programme in Zimbabwe.

The constraints to sector development that were identified at the beginning of the Decade and reconfirmed at the mid Decade review, that is, socio cultural constraints particularly slow behavioural change and technology acceptance, and lack of self help contributions; institutional constraints particularly lack of manpower and planning capacity; and financial constraints particularly lack of capital investment at national level, and credit

plus cost recovery at village level; are crude generalizations that are difficult to correlate to the situation in Zimbabwe. It can be seen from the case studies that communities were willing to provide self help labour to construct and use water and sanitation facilities, and that these appropriate technologies were generally acceptable if they continued to function properly. It was also seen that much of the planning was undertaken by donors, and that a vast array of extension workers was available to implement these projects. Furthermore, capital investment from donors was readily available, and the feasibility of providing recoverable credit at village level was demonstrated in a large project implemented by CSSD, a local NGO.

In Zimbabwe the main constraints to achieving the goals of the Decade can be summarized as follows. First, that the sector development process that is taking place is long and beyond the length of the Decade. The beginning of the present cycle of sector development can be traced to the early 1970's and is still continuing. Second, the pressures of donor agencies to absorb the over generous flow of aid funds which overwhelm the capacity of Government, and results in donors providing technical assistance to fill line management functions (see table 29), which in turn leads to other problems such as the inhibition of the development of skills in national staff. Third, lack of coordinated planning due to professionalism, sectoralism and donor bias caused by the technocrats representing both the donors and Government. Both the second and third points listed above were particularly apparent in the preparation of the NMPRWSS. Fourth, lack of a widely adopted implementation strategy that includes involving local government and the recipients in the planning of projects. Fifth, central Government's inability to recognize its own limitations in direct project implementation and failure to make better use of alternatives such as NGOs who have a proven record in Zimbabwe. Sixth, poorly designed projects that did not have a clearly defined developmental context

or objectives, and that were often illogically designed even with respect to their own lower level goals, particularly with regard to cost recovery and sustainability. For example, St. Theresa's project in which the resources provided by the donor could not possibly achieve the goals established.

From the constraints listed above and the lessons culled from the case studies as summarized in chapter 16 it is possible to categorize the sector development process that took place in Zimbabwe into distinct phases and to list a number of basic principles that should be observed in project design. However, at this point before attempting to construct a model for sector development and project design we should reexamine two of the definitions provided at the beginning of this thesis in light of the study findings.

17.2 Redefining Communities and Vertical Projects

The concept of a community as often perceived by donors and developing countries should be qualified. It was found that communities were not democratic and homogeneous groups striving for development, but a complex interaction of individuals, families and other sub groups, often times in conflict because of jealousies and greed et cetera. Examples of this could be seen in the CSSD project where men became jealous of the attention given to women, and became obstructive. In the Crash Borehole Drilling Programme, a major problem was the removing of the borehole siting pegs, which had been optimally located by hydro-geologists in consultation with the community, to new positions which favoured the village elites. Another example is the disfavour shown to some Village Health Workers because of their conflict with the traditional midwives, or because of their youth. This indicates the complexity and difficulty in promoting community participation and mobilizing the masses, which may be why many project designers avoid addressing the issue. The term "community" has become a

label often used by donors and government to generalize a complex reality that is difficult to understand and analyze.

The definition of a vertical project should also be qualified. The terms "top down", and "bottom up" projects, which refers to the method of their planning and implementation, are crude generalities which often fail to convey the realities of unique project situations. In the case studies we can see two extremes. The supposedly bottom up approach of the NGOs who are close to the community during project planning, but often fail to pass upwards their proposals to be incorporated in regional or national plans. At the opposite extreme we saw bilaterally funded projects designed at national level that involved the community in the choice of borehole sites. We also saw a National Master Plan that failed to encompass some of the main tenets of Governments rural development policy. These highlight the complexity and difficulty in planning community based development programmes, and draws attention to other concerns which are, the planning that takes place without a full understanding of the environment in which the project is to be implemented, and the planning for the special interests of the planners.

It should also be borne in mind that each of the case studies that were reviewed had its own unique context, and often the strategies and components adopted in these projects have evolved or been adapted to suite that special situation, and that lessons learned in these projects may not be universally applicable. Any project model should be based on a series of flexible and adaptable principles and guidelines.

17.3 A Model Rural Water Supply and Sanitation Sector Development Process

It has become clear that in order to improve rural service levels in the water and sanitation sector of a developing country a programme has to be implemented that

is by necessity low cost and community based. However, to launch such a programme a process has to be initiated, a model, which is likely to be similar to that of the recent experiences in Zimbabwe. It cannot be claimed that this is a universal model, however, there may be a number of facets that similar or applicable to the situation and status of other countries. This sector development model progresses through a series of phases or stages, from pilot project to demonstration project, to policy formulation and political commitment, to the attraction of external funds and the subsequent expansion into a national programme, and the absorption of these sector activities into a broader rural developmental process. While preparing sector projects, the designer must bear this process in mind to ensure that the proposed activity fits the correct stage of this process appropriate to the current level of sector development in that country. Within the sector development process three distinct major phases can be identified. The pilot phase, the demonstration phase, and the replication and expansion phase. These phases are characterized by the following activities and objectives.

During the pilot phase small scale, free standing, experimental projects or activities are undertaken in order to develop, test and define technologies and implementation strategies that have potential for resolving problems and constraints identified in the sector. This phase can be long and complex.

During the demonstration phase, often free standing, larger scale projects or activities are undertaken in which the technologies and implementation strategies developed in the pilot phase are further tested and their effectiveness demonstrated in order to foster community and political support for innovative approaches to improving service levels and coverage.

During replication and expansion, the successes of the demonstration phase are replicated and expanded to a large scale programme that has potential for having significant impact on national service and coverage levels.

The beginning of this phase is often marked by policy formulation and change which provides a trigger for this full scale production and expansion of activities, which then attracts increased investment from donors and domestic sources. It also marks the legitimizing of the technologies and delivery mechanisms, which enables their absorption into other sectors such as rural development, and health. At this point successful water and sanitation projects may become the "entry point" for development initiatives in other sectors such as health or agriculture.

17.4 A Model for The Design of Rural Water Supply and Sanitation Sector Development Projects

The model for the design of rural water supply and sanitation project presented below is based on the experiences of Zimbabwe. It is idealized, flexible and has two facets. Firstly, a set of basic principles that should be followed when preparing project proposals, and secondly, more specific guidelines on a number of essential project components. A summary of the Zimbabwe systems model is presented in table 30, and it is shown diagrammatically in figure 21.

It is recommended that the following basic principles should be observed. Project designs should balance between providing for the basic needs of the community, and the need to strengthen or build the capacity of government to execute future projects. Internally, projects should be logically designed with a rational relationship between expected outputs and proposed inputs. This should take into account the long lead time required by community based projects. Emphasis within project designs should be placed upon building maintainable structures. Whereas, emphasis in programmes should be placed upon designing replicable projects. When sector development has reached the expansion phase, designers should seek to identify links and to integrate water and sanitation activities into other sectors particularly

Table 32. Summary of an Idealized Supra Systems Model for Rural Water Supply and Sanitation Sector Development Based on Experiences in Zimbabwe.

1. Goal and Objective

Improved health and economy through the provision of improved water, sanitation and education in a broad rural development framework in which water can be the entry point.

2. Inputs, Outputs and Transformation Process

Finance and expertise which is provided by the donors is transformed into water and sanitation infrastructure by governments and communities through a process of designing and implementing projects and programmes. However, the projects must be rationally and logically designed so that the outputs can be achieved with the given inputs

3. Key Concepts

- a) Projects should provide a balance between providing for basic needs at community level and institution building.
- b) Communities should participate at all levels in planning and decision making.
- c) Projects should be simple and address specific issues, but be set in a broad rural development framework or context and coordinated with activities in other sectors such as health and agriculture.
- d) Costs should be borne by the community.
- e) Programmes should evolve adaptively from small projects.
- f) Projects should integrate water, sanitation and education components and be based on appropriate technology and community management.
- g) Projects should be systematically monitored and evaluated in order to feed the evolution process.
- h) The principles of replicability and sustainability should be strictly adhered to. Projects should be reviewed to ensure that they can be replicated nationally and sustained by the community before proceeding.
- i) A full understanding of the structure, needs and priorities of the community groups should developed before embarking on a project design or implementation.
- j) The importance of dynamic leadership is clear. Projects should include for leadership succession training.

4. The Systems and Their Functions

- a) Donors should provide financial and technical resources to governments in order to strengthen their capacity to undertake development interventions. Specifically, to motivate, mobilize and support communities. They should also coordinate their programmes to ensure overlap does not occur and optimum use of resources. Donors should also encourage government to develop sound fiscal policies and sectoral priorities that are removed from political interference. Donors should guard against introducing potentially conflicting elements such as domestic research and private sector interests.

d) Governments are responsible for establishing policy, directing and coordinate donor support and creating an environment conducive to development by strengthening local level planning and implementation capacity. This includes motivating and mobilizing communities into self help efforts and providing technical financial and educational support. Government bodies should coordinate their programmes to ensure overlap does not occur and optimum use of resources. Local research into issues constraining the sector and their solutions should be encouraged.

c) Communities should participate in planning, constructing, managing and maintaining the water and sanitation systems.

5. Some Key Actors and Their Perceived Roles

a) Donor experts should concentrate on training national staff and other institution building activities in order to increase local capacity.

b) NGOs should be used by governments to supplement extension workers as intermediary in their communications with communities. That is, as systems boundary spanning mechanisms.

c) The domestic private sector which is a largely untapped resource, should play an increasing role in accelerating the development and operations of water and sanitation systems at local level.

d) Women because of their role as the carriers of water and guardians of family health should be a major focus of mobilization and education campaigns.

6. The Supra Systems Dynamic

As sector development progresses from small scale pilot activities to large scale programmes in an adaptive learning process the function of the systems and role of the actors will change over time. For example, the donors role may change from providing intensive technical assistance in training and institution building to simply providing funding. Whereas, the community role may change from being observers of pilot projects to project planners and implementors. This dynamic process also relates to the integration of water and sanitation projects into other sectors. The initial pilot projects may be free standing, whereas during the expansion phase water and sanitation may be fully integrated into health or agricultural programmes.

Figure 21

Idealized Supra Systems Diagram of the Rural Water Supply and Sanitation Sector in Zimbabwe.

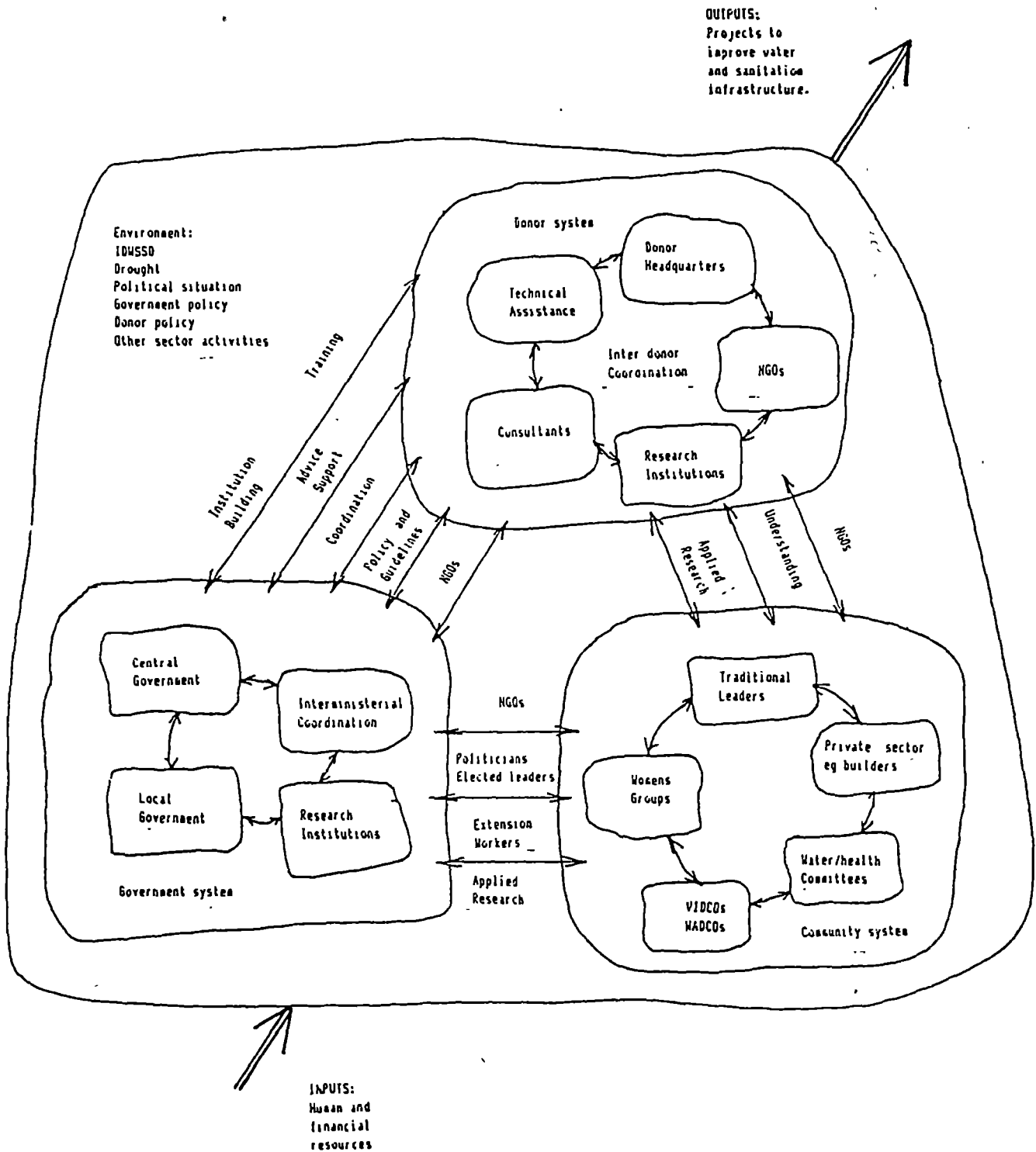

integrated agriculture, rural and urban development and health projects. More specifically, project designs should take into account the following. First, that popular mass participation by the community is essential in order to mobilize the required resources for sustainability. Second, that communities should be substantively involved in the decision taking at all stages of the project design and implementation. Third, that projects should be simple with limited attainable objectives focussed on removing one or two key critical constraints to sector development. Fourth, that the contact with communities should be through agencies that have skills in communications, in order to mobilize and organize them effectively. Often governments do not have the skills and capacity to undertake this. They should therefore divorce themselves from this, and seek to involve the resources of the NGOs and the private sector (the potential role of governments, donors, and communities are reviewed below). Fifth, that within a project the respective roles of the parties involved should be clearly defined at the outset.

Communications and community participation are closely related and although many projects pay lip service to these ideas, few if any, truly involve the community from the initial planning phase. To do so endangers the designer's preconceived notions as to how the project should be conducted and their control, or indeed it may also jeopardize the future of the project should the community have other priorities. In centrally designed projects where the community are not involved in the initial planning process, to inform them later about the project, and of their expected contributions (which is often the case), is a difficult and time-consuming activity that brings potential conflict and protracted debate, which could be avoided if earlier discussions had taken place. In any community involvement/communications strategy a pivotal issue is the involvement of women who are invariably the carriers of water and managers of the domestic water cycle, and the guardians of the family health. Any behavioural change of the family particularly in children is clearly

largely in their hands. Two other contentious project components should also be highlighted here, that is, cost recovery and leadership.

The issue of cost recovery within projects should be squarely faced by the donor community and developing country governments if there is to be any appreciable improvement in service levels in the sector. The issue is really quite simple. In order to accelerate and expand the provision of services (or at least keep up with population growth), scarce development capital needs to be recirculated back into the system. Otherwise the speed of the programme is regulated by the levels of grant and subsidy that can be provided by donors and government. If politicians are unwilling to forego the political leverage that water projects clearly provide them, at the very least, donors and governments should not abandon projects without establishing internal mechanisms that recover maintenance costs in order to ensure the sustainability of the investment.

Each of the successful projects reviewed was led by a dedicated individual, often an expatriate, whose energy, flexibility and commitment overcame any shortfalls in the project design, thereby allowing the project to be driven along to a successful conclusion. This has been seen by some as being a limiting factor in replication of projects in developing countries. However, it is believed that this presents one of the best indicators of the area in which sector development agencies should concentrate, that is the training of a dedicated band of developmentalists, or "new professionals" as they were referred to by Chambers (1985). This training should be focussed in two areas, the training for leadership succession and institutional strengthening.

17.5 The Role of Government, Donors, and the Community in Projects and Sector Development

Having proposed a model for sector development and project design we should consider what are the appropriate

and relative roles of the three interested parties, that is, donors, governments and communities. Often one of the major constraint to sector development is government's misguided belief that it has a primary responsibility for the provision of water and sanitation services. However, because of its limited capacity, lack of communications skills and inflexibility, government often becomes the constraining rather than the enabling factor. Wherever possible governments should divorce themselves from the direct provision of services and concentrate on providing an environment in which service levels can be improved by utilizing the resources of intermediaries, particularly NGOs and the private sector. Government's role should be to provide a catalyst for development through innovative policies, promotion, training and technical assistance, that is, government should play an enabling role. An essential part of this role is the establishment of interministerial and hence, intersectoral coordination, and appropriate deployment of extension agents.

NGOs, because of their flexibility and social skills have a proven record of being able to communicate effectively with communities and mobilize their latent resources. Government should harness these skills and use the NGOs as effective agents of change and development within prescribed policy guidelines. Similarly, government should harness the resources of the private sector, particularly in the construction and maintenance of facilities. This is a particularly effective mechanism of improving cost recovery and financial performance in the sector.

A second major constraint to sector development is often related to the policies, preconceptions and disbursement pressures of the donor agencies. The role of donors should be to support governments in creating the environment and catalytic effect described above through training of trainers, technical assistance and financial support. They should however, divorce themselves from direct involvement in policy formulation and line

management of projects. Donor funds should be unconstrained and flexible so that they can support pilot projects in which innovative approaches to the provision of services can be developed and demonstrated.

In general NGOs should be used as the interface between government and the community, whereas, the bilateral donors should concentrate on central institution building and training activities. Clearly the role of government is to coordinate and control this, and to ensure that the local level authorities are involved in an iterative planning process.

In Zimbabwe, in order to transform the existing rural water supply and sanitation supra system as summarized in table 31, to the idealized model shown in table 32, a number of fundamental changes must take place in each of the systems. Donors must begin to move away from the direct implementation of welfare projects and concentrate on building the capacity of Government to plan and implement its own development interventions. Donors should coordinate their programmes and build upon the development process that is taking place and avoid subverting it.

Government should abandon its welfare approach to the provision of services for all, and recover costs from those who can afford. It must take a stronger role in the direction and coordination of donors and their programmes, and in the internal coordination of the various ministries and institutions involved. Government should also make better use of NGOs and the private sector to supplement its extension activities and programme implementation. The main function of Government must be to establish an environment conducive to development through continued strengthening of local level capacity to plan, manage and maintain their own assets. The direct provision of services from the centre should be phased out as local capacity is increased.

Communities must take a much more active role in determining their own needs and priorities, and in mobilizing local resources to fulfill these needs. After

a facility such as a water system is constructed, the community must take full responsibility for managing its operation and maintenance with technical advice and back stopping from the local government structure.

17.6 Water and Sanitation Master Planning

As Browne recently stated (pl, 1987):

"Most master plans would make a good annex to a master plan!"

The Zimbabwe plan is no exception to this. It provided a vast amount of data; an inventory of the sector, together with twenty years forward projections of population and service needs, and a proposed development budget. However, the development strategy, process, and policy recommendations are hard to find, other than those which have recommended radical institutional change and thereby caused controversy and confrontation.

Water and sanitation master plans for developing countries should provide as background, a brief and concise sector situation and needs analysis. However, its core should be a sound yet simply stated, strategy and policy for improving the sector based on a developmental process. Annexes may include a list of priority projects or needs but, this should be flexible and the list should be updated and revised periodically in a dynamic process. The plan should be prepared in-house by government through an iterative process with local level planners assisted by external technical support if needed, but it really is time to abandon the classical expatriate consultants' master plan. The developing world is littered with hundreds upon hundreds of volumes of consulting engineers studies that have little or no developmental impact.

17.7 The Need for Further Research

This thesis has raised a number of issues and questions many of which remain unresolved or which have opened new

avenues of thought. It may be worthwhile to outline the possible direction of further research in this field. Four inter-linked research topics have been identified in the areas of impact evaluation of water and sanitation interventions on the process of rural development and the development of improved methods of delivering development aid. These topics which may assist in improving project design are listed below.

First, the determination of the socio economic impact of a water, sanitation and education intervention into a community. After more than two decades of speculation recently improved health impact research methodologies, that is, case control studies, have confirmed that there are positive benefits to be gained from water and sanitation projects (Aziz et al., 1989). This research should be taken further to determine what are, if any, the resulting broader socio economic benefits of water and sanitation interventions in order to assist in establishing priorities for development investments.

Second, as a further extension to the health impact studies referred to above it is believed that there is a need to determine the relative weights and benefits of the individual project components, that is, water as opposed to sanitation or education, or vice versa, in order to determine the optimum investment patterns within project and programme design.

Third, it is also recommended that further in-depth studies should be carried out to quantify the potential mutual benefits to be obtained by integrating water and sanitation projects with health or agricultural projects.

Fourth, there is clearly a need to scrutinize the policy, approach and disbursement pressures of the different types of donors within the sector and to relate this to the success and quality of their projects as a means of determining possible improvements to the delivery of foreign aid.

This thesis also draws attention to a further issue related to developmental research - who are the most

appropriate bodies to undertake these activities? We have seen that researchers from developed countries by concentrating on components of projects rather than projects as a whole have reinforced poor project design. Whereas, the timely and appropriate research undertaken in Zimbabwe by the Blair Research Laboratory, the results of which were fed back into the design process has contributed greatly to better project design and to the development of the sector. Establishing links between developed and developing country research institutions can only be beneficial to both sides.

17.8 The Value of a Systems Analysis Approach

In conclusion the use of a systems approach to the analysis of the problems of improving the rural water supply and sanitation sector in a developing country should be commented upon. Although it would be wrong to claim that systems analysis is a precise science, what it has usefully provided is a balanced and structured way of looking at a complex reality that consists of several dynamic and interactive parts within a broader environment. This balanced approach is necessary in realities that are dominated and characterized by one or more of the parts. The limitations to the use of a systems approach is dictated by the user ability or inability to develop a full understanding of each of the component parts of a system, particularly the less dominant or poorly documented components. A number of opponents of systems thinking have claimed that it is unable to deal with dynamic situations that change over time. This was found not to be the case. By using the technique of comparing a series of systems relationships over a period of time, the dynamic changes in the relationships within a process can clearly be identified.



- o 0 o -

Annexes

- o 0 o -



Annex 1World Health Organization Minimum Evaluation Procedure
For Water Supply and Sanitation Projects

The Minimum Evaluation Procedure (MEP) document describes a relatively cheap, simple and quick method of evaluating water supply and sanitation projects (WHO, 1983). The guidelines are directed primarily towards managers of water supply and sanitation programmes which employ simple technologies. They are less appropriate for large urban projects employing sophisticated technology, and they concentrate on evaluation of functioning and utilization of facilities and complementary hygiene education; the evaluation of impact is not considered in great detail.

The technique was developed jointly by the World Health Organization together with the London School of Hygiene and Tropical Medicine. Its emphasis is on the collection of basic information and data on the functioning and utilization of projects, and the employment of this information to improve project performance.

The MEP is based on the concept that there are three sequential stages that may be evaluated in a project, functioning, utilization and impact. Deficiencies found in the evaluation of a particular stage call for the improvement in the output of the previous stage or in the inputs to the stage under review. There is, therefore, little value in evaluating a particular stage unless the objectives of the previous stages have not been largely achieved. Furthermore, evaluation of impact is only appropriate for projects known to be correctly functioning and properly utilized. MEP identifies a limited series of indicators that may be used to provide data on the status of a project.

The indicators are:-

1. For Functioning of Water Supplies

Indicators W1 : Water Quantity

" W2 : Water Quality

" W3 : Reliability

" W4 : Convenience

2. For Functioning of Sanitation

Indicator S1 : % households having latrines

" S2 : Sanitation hygiene

" S3 : Sanitation reliability

3. For Functioning of Hygiene Education

Indicator E1 : Understanding the language of the message

" E2 : Understanding the content of the message

" E3 : Access/Receiving the message

" E4 : Contact with the educators

4. For Utilization of Water Supplies

Indicators W5 : Proportion of households using the facility

Indicator W6 : Volume of water used and for what purpose

5. For Utilization of Sanitation

Indicator S4 : Proportion of people using latrines

6. For Utilization of Hygiene Education

Indicator E5 : Water Storage Habits

" E6 : Handwashing after defecation

" E7 : Knowledge of Oral Rehydration

The MEP then goes on to provide a sample protocol for a household survey questionnaire that asks a series of questions based upon the key indicators, examples of these are shown at the end of this annex.

The MEP document provides a good basis and background for proceeding with an evaluation exercise. However, it should be used with caution. The household survey protocol

must be modified and adapted for individual project circumstances, and a number of the indicators can only be properly measured with rigorous observational studies and in comparison with baseline or control community data, e.g. water use studies behavioural change patterns etc. Unfortunately, the document mainly provides a guide to carrying out a sample household survey using a questionnaire. In order to be complete, one would have expected the MEP to contain, a protocol for carrying out a limited baseline survey linked to the identified indicators and also a methodology for carrying out simple observational surveys (Boydell, 1985).

HOUSEHOLD SURVEY QUESTIONNAIRE

Province:
 District:
 Village:
 Interviewer:
 Date:

Indi-
 cator

1. Household identification

_____ (Use number from sampling frame)

W1 2. Number of household members

Adults		Children < 5 years		
M	F	M	F	
Total				

3. Socio-economic status

_____ (Use plot size, house size, number of cattle, educational level or other locally relevant indicators of wealth and/or income.)

WATER SUPPLY

W5 4. Are you using water from the community water supply?

Yes No , of no continue to Question 17

W5 5. What type of service do you have?

House connection , continue to Question 9

Plot connection , continue to Question 9

Communal water point

Well with handpump

Well without handpump

Other

W4 6. How far away is the water point? _____ meters (estimated)

W4 7. How long does it take to go there, _____ minutes (estimated)
 fetch water and come back?

Indicator

8. Who collects the water?

Children
Women
Men

Usually	Sometimes

W6 9. How much water is collected each time? _____ litres (estimate)

W6 10. How many times a day is water collected? _____

W3 11. When was the supply last not functioning? _____

W3 12. How frequently do breakdowns occur?

Never Dry Season Monthly Weekly
Other , specify _____

W3 13. For how long do breakdowns last? _____

W5 14. How much do you pay for the water service? _____

W6 15. For what purpose is the water collected being used?

Activity Approximate estimate of percent or proportion

Drinking and cooking
Washing of food and utensils
Personal washing
Washing of clothes
Watering of animals
Watering of garden
Other, specify

100%

W6 16. Do you use any other water source for any of the above activities or any other activities? _____

Indicator

W5 17. What water source do you use for the following activities?
(This question only applies to those who are not using the water supply.)

	<u>Activity</u>	<u>Water Source</u>	<u>Distance (estimate)</u>
A. <u>DRY SEASON</u>	Drinking and cooking	_____	_____
	Washing food and utensils	_____	_____
	Personal washing	_____	_____
	Washing of clothes	_____	_____
	Other	_____	_____
B. <u>WET SEASON</u>	Drinking and cooking	_____	_____
	Washing food and utensils	_____	_____
	Personal washing	_____	_____
	Washing of clothes	_____	_____
	Other	_____	_____

W4 18. What is the distance from your house to the closest project water point? _____ meters

W5 19. For what reason(s) are you not using the water supply?

- Traditional source more convenient
- Water supply too expensive
- Water from the supply does not taste good
- Considers water from the supply unhealthy
- Conditions at water point unsanitary
- Children cannot reach or turn the tap
- Children cannot operate the handpump
- The supply is unreliable
- Would like to participate but cannot because:
 - not a member of the water group
 - have not paid the fees
 - other reason(s), specify
- Excluded by others because:
 - social, cultural or religious reasons

Some probable categories, actual categories to be established through pilot interviews

W5 20. What changes would be needed for you to use the supply?
(This question applies to those not using the supply)

Indicator

- W5 21. In what way would you suggest the water supply services could be improved?
 (More information to and involvement of consumers, improvements in the system for revenue collection, improvements in maintenance, training to operators, removal of social barriers)

SANITATION

- S2 22. Have you built a latrine?
 Yes , which type (if options)
 No , continue to Question 27
- S2 23. When was it completed? _____ (month/year)
- S5 24. How many of the household use the latrine regularly?

Adults		Children < 5 years	
M	F	M	F

- S3,S4 25. Are there any problems with the latrine?
 e.g. Flies and/or mosquitoes
 Smell
 Flooding in rainy season
 Difficulties for the younger children to use it
 Emptying (if applicable)
 Other
- } Some probable categories, actual categories to be established through pilot interviews

- S3,S4 26. How do you think the latrine could be improved?

- S1 27. Have you been informed about the support the Government is providing for latrine construction? (Applies to those without a latrine)
 Yes No

Indicator

S2 28. If yes, have you considered participating in the programme?

Yes No

S2 29. What is the reason(s) why you have not yet joined or why you do not wish to join?

- The latrine is not needed
- The latrine is too expensive
- No time to build
- Do not know how to build
- Have tried but have been told
it is not yet my turn
- There are no squatting slabs left
- Other reason

} Some possible categories,
actual categories to be
established through
pilot interviews.

Annex 2Sample Protocols for the Technical Inspection of Wells and Latrines2.1 Example of a Latrine Technical Inspection ProtocolVentilated Improved Pit-latrine
Construction Standards EvaluationDistrict _____ Communal/Resettlement Area _____
Ward _____ Village _____

Latrine Number _____

PART A

- | | | |
|------------------------------|-----|----|
| 1. Is the latrine completed | yes | no |
| 2. Is the latrine being used | yes | no |

PART B

- | 3. Depth of pit | 0m-2m | 2m-3m | 3m-4m | 4m-5m |
|---|-------|-------|---------------------|-------|
| 4. Pit fully lined | | | yes | no |
| 5. Collar provided in unlined pit | | | yes | no |
| 6. Floor slab; smooth finish | | | yes | no |
| 7. Floor slab; standard size hole | | | yes | no |
| 8. Floor slab; sloping to centre | | | yes | no |
| 9. Superstructure; entrance width adequate | | | yes | no |
| 10. Superstructure; enough space to squat comfortably | | | yes | no |
| 11. Roof; no light passing thro and rain proof | | | yes | no |
| 12. Vent pipe; directly above pit | | | yes | no |
| 13. Vent pipe; 600mm above highest roof level | | | yes | no |
| 14. Vent pipe; fly screen fitted and intact | | | yes | no |
| 15. Vent pipe; smallest cross section | | | _____ mm x _____ mm | |

PART C; Maintenance and Performance of Latrine

	Good			Bad	
	1	2	3	4	5
16. Odour in superstructure					
17. Flies in superstructure					
18. Mosquitoes in superstructure					
19. Floor fouled with excreta					
20. Floor fouled with urine					

Guide to completing table;

16. Odour
- 1 = no odour
 - 2 = little odour
 - 3 = smells
 - 4 = bad odour
 - 5 = overpowering odour
17. Flies
- 1 = no flies
 - 2 = 5 flies
 - 3 = 15 flies
 - 4 = 50 flies
 - 5 = 100+ flies
18. Mosquitoes
- 1 = no mosquitoes
 - 2 = 5 mosquitoes
 - 3 = 15 mosquitoes
 - 4 = 50 mosquitoes
 - 5 = 100+ mosquitoes
19. Excreta fouling
- 1 = no fouling
 - 2 = fouling around hole
 - 3 = two stools on floor
 - 4 = five stools on floor
 - 5 = more than 10 stools
20. Urine fouling
- 1 = no fouling
 - 2 = fouling around hole
 - 3 = 10% of floor saturated
 - 4 = half of floor saturated
 - 5 = whole floor saturated

NB. Equipment required by each enumerator;
 mirror mounted on a pole
 tape measure

Latrine Survey

Definitions and instructions

- Question 4; fully lined means brick or rock lining to the full depth of the pit
- Question 5; collar means a brick or concrete ring at the lip of the pit below the floor slab
- Question 7; a standard size drop hole is 300mm x 150mm
- Question 8; sloping to the hole means that the floor is finished with a slope to allow urine to drain off
- Question 12; the ventilation pipe or chimney should be vertically above the pit without offsets
- Question 15; measure or estimate the smallest cross section at any level in the chimney which should have a minimum clear opening of 225mm x 225mm

Annex 3The Logical FrameworkAn Analytical Tool For Project Evaluation and Design

In 1969 USAID commissioned a management consultancy company, Practical Concepts Incorporated (PCI), to analyse their project evaluation methodology. The analysis identified three problems constraining meaningful project evaluation which were also detrimental to project implementation.

a) Project Planning was Vague: Project Objectives were multiple and not clearly related to project activities, ie. the outputs expected from the project could not often possibly be achieved with the planned inputs and often this input/output relationship was not even stated.

b) Management Responsibility was Unclear: Project Managers, although aware that projects should be justified in terms of their benefit or impact, were reluctant to be responsible for the impact on the grounds that there were too many external factors beyond their control.

c) Evaluation was seen as a Negative Process: With the absence of clear targets and responsibilities, evaluations often ended up in disagreement as to what were the project's original goals and what had been achieved, rather than in seeking constructive actions for project improvement.

The "logical framework" (PCI, 1969) attempts to set out a concise one page summary of major project elements and their relationship to each other, thereby facilitating a cause and effect approach to project design and analysis. The results of the process of using the logical framework concepts can be displayed in a 4 x 4 matrix that indicates a hierarchical process from project input to outputs to purpose to goal related to verifiable indicator, and assumption regarding externalities at each level. This hypothesis is depicted in figure 22, and an example of a

Figure 23.

An Example of a Logical Framework for a Rural Water Supply & Sanitation Project (from Boydell, 1984b).

NARRATIVE SUMMARY	OBJECTIVELY VERIFIABLE INDICATORS	MEANS OF VERIFICATION	IMPORTANT ASSUMPTIONS
(Programme goal) Improvement of health Improvement of environment Improvement of socio economic status	(Goal achievement) Decrease in faeco-oral diseases by N% N hours per person per day released for other socio-economic activity	Evaluations & impact studies Health records Environmental studies	(Re long term value of project) Drought does not reoccur Other PHC interventions eg. EPI MCH etc are available
(Project purpose) Increased coverage and use of latrines & protected water sources Increased knowledge of hygiene and disease Decreased water carrying burden	(Purpose achievement) % of community using latrines and protected water sources increased Value of handwashing & safe water storage known by N% of community Distance to nearest protected water source reduced by N meters	Physical & socio economic surveys Observational studies	(Purpose to goal link) Communities able to maintain wells & latrines Health/hygiene education follow up takes place
Trained project staff & builders available Community mobilised Latrines & wells constructed Education campaigns undertaken	(Outputs necessary for purpose achievement) Number of wells & latrines constructed/coverage Knowledge of hygiene increased	Monitoring Project records Reports	(Output to purpose link) Project staff able to effectively mobilise community Community able to contribute time labour & cash Community able to understand health messages
(Inputs) Training of project staff Education & communications materials Training of builders Supply of materials & equipment	(Levels of effort and provision) N project staff trained N builders trained N villagers mobilised N bags of cement and handpumps provided plus vehicles etc	Project records Reports	(Input to output link) Project staff and builders available Finance & transport available Community perceive project need

Annex 4Checklist of Project Evaluation Questions

Set out below is a comprehensive checklist of questions that may be used in the evaluation of development projects and in the formulation of project management case studies (from Goodman & Love, 1979) :-

A4.1. Phase 1 - Planning, Appraisal and Designa) Identification and Formulation

- Was the project identified in the course of the national development planning process? If so, what was the policy-making character of this process?
- Can the national planning process ensure that policies and programs for economic and social development at the national level are translated into or integrated with counterpart plans at regional and local levels?
- Did the original project idea relate to problems identified in the national or sectoral or regional plan?
- What were the major environmental factors - political, economic, social, cultural, technical, or others - that led to the project?
- What was the primary source of the project idea?
- Who were the individuals or groups that first proposed the project?
- Did other organizations become involved in defining the project?
- What was the role of external donors or international funding agencies in project identification?
- Who, other than the earliest proposers, supported the project idea? Who opposed it?
- Were other groups or individuals involved in the preparation, such as: clients, users, beneficiaries, political supporters or opponents, resource suppliers, and potential project implementators?

logical framework statement for a rural water supply and sanitation project is shown in figure 23. The logical framework approach to project planning and evaluation is broadly accepted by a number of donors and agencies including USAID, GTZ, CIDA and others.

Figure 22.

Diagram Showing the Causal Hypothesis of
The Logical Framework (from PCI, 1969).

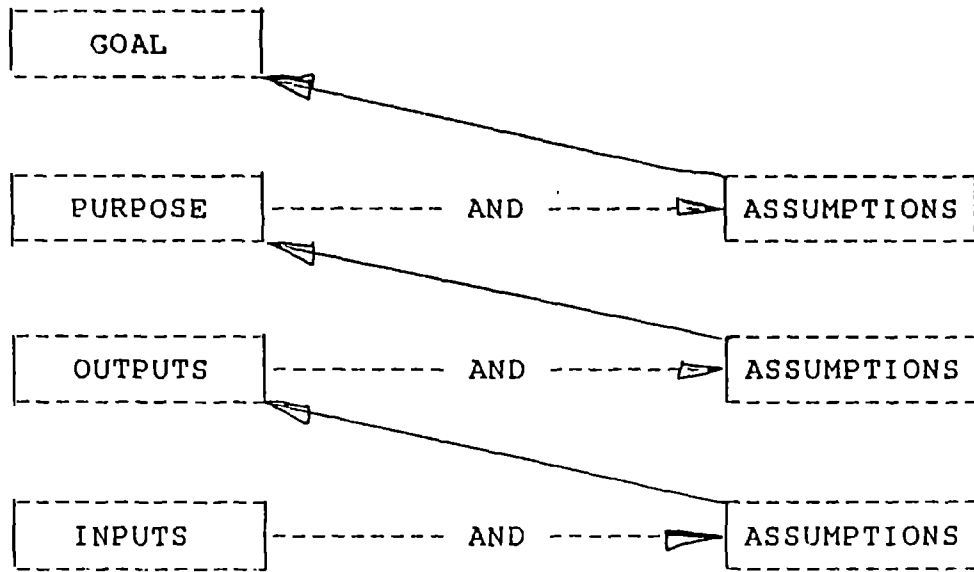

- How and by whom was the initial idea justified in order to be included in the country's investment program? Should it be in the program at this stage? If so, how?
- Were prefeasibility studies done?
- How clearly and explicitly were the purposes and goals of the project stated or defined? Were the major potential problems also identified at this time? Were the time constraints taken into consideration?
- Was there general commitment to the goals of the project by all of the constituencies in its design? From whom could political administrative support be initially counted upon? What resources did these supporters have? What conflicts arose and how were they settled?

b) Feasibility Analysis and Appraisal

- How extensive was the preliminary design? Who prepared it?
- Was a formal feasibility analysis conducted?
- Who conducted it? Was it a national organization, an international assistance agency, a consulting team, or a combination thereof?
- How comprehensive and detailed were:
 - . the technical feasibility studies (project location and lay technology needs, training of technical personnel)?
 - . the financial feasibility analysis (investment analysis, project capital needs at various stages)?
 - . the economic feasibility analysis (national economic benefit demand forecasting, comprehensive economic analysis)?
 - . the market and commercial feasibility studies?
 - . the location studies?
 - . the political feasibility assessment?
 - . the administrative, organizational, and managerial studies?
- Did the studies reveal any weaknesses in the project that might affect future operations? If so, what were these weaknesses?
- What appraisal criteria were used? Who had the authority

for appraisal?

- What procedures were used during the appraisal process? How many stages did it go through?
- Did the appraisers and reviewers make an onsite inspection?
- Were there any reservations about the overall ability of the project to succeed? If so, what were these reservations? Were there any other problems that other appraisers foresaw that were not included in the final appraisal?
- How were uncertainties and gaps in the reliable estimates or projections affecting project appraisal dealt with?

c) Design

- What were the major sources of data or of information used in designing the principal components of the project?
- How well did the project design reflect the initial objectives and targets of the project idea?
- How clearly and explicitly were the purposes and goals of the project defined and stated? Were immediate goals distinguished from longer-range goals? Were project objectives related to broader development policies?
- Did the proposal include measurable targets for attaining objectives and specifications for the project's outputs?
- Did the source of the project's identification influence how it was prepared and designed?
- Was an attempt made to identify the potential project manager and to involve him in project design?
- Were the project's activities, functions, tasks, and components clearly identified and defined?
- How many and what kind of design alternatives were considered and analyzed? How were these alternatives evaluated and chosen?
- Were preconditions or prerequisites of success considered during the design task? Were potential problems or bottlenecks to successful implementation identified?
- Were potential social and cultural impacts of the project

- taken into consideration in its design? Were adverse effects identified? If so, how was the design modified?
- Did the project design indicate an adequate mechanism for internal and external communication requirements?
 - Were linkages and relationships with complementary or competing projects examined?
 - In how much detail were plans, specifications, job descriptions, and work schedules prepared?
 - Were alternative organizational arrangements for project execution and operation considered? Were plans made for expanding administrative capacity of the potential project implementation unit?
 - Did the project organization maintain a balance - appropriate to project task - between technical and managerial persons functions?
 - Were the different elements of the project design integrated in a coherent whole? Was there one person responsible for integration?

A4.2. Phase 2 - Selection, Approval & Activation

a) Selection and Approval

- What appraisal and selection criteria were used?
- How many stages of review were necessary before final selection approval? Who participated in the review, selection, and approval processes? Did these stages involve:
 - . obtaining legislative authorization?
 - . obtaining executive approval?
 - . confirming procedures for budget operation, personnel management, and interagency operation?
- Did any changes occur in the project environment from the time of the feasibility study that affected project approval?
- How long did the appraisal, selection, negotiations, and approval process take? What were the major sources of delay, if any?
- What major factors - political, social, technical, economic, administrative, or others - influenced

decisions at each stage of the review?

- How were uncertainties and gaps in the reliable estimates or projections affecting project appraisal and selection dealt with?
- Was the proposal in competition with other ones? If so, was the project appraised and evaluated comparatively with these others?
- Which of the following criteria were used in selection:
 - . linkage with national or local development thrusts?
 - . accelerating the pace of economic and social progress in the area?
 - . availability of natural resources and raw materials?
 - . considerations of priorities dictated by political pressures?
 - . cost and duration?
 - . other criteria?
- From what sources was the project to be financed and funded? Which organizations - national or international- provided other basic resources or inputs?
- Who was involved in negotiation of loans or grants or other forms of funding for the project? What were the major issues of negotiation? What were the positions of the negociators? How were differences resolved?
- Were constraints and conditions placed on the project's design or operation by the selection, approval, or funding authorities? Was the plan modified to conform to those conditions?

b) Activation

- What criteria were used in choosing a project implementation unit or executing agency?
- What variables influenced the choice of organizational structure?
- What was the relationship between the project implementation and higher organizational authorities in terms of responsibilities and support?
- Who was included in the project team? Were they transferred from their previous responsibilities

- temporarily or permanently? Were they on a part-time basis or on a full-time basis?
- What were the criteria used in personnel selection for the project staff and for the project manager? What recruitment methods were used?
 - Were the project leader and the project team given their responsibilities clearly? Were they provided an orientation or a period of retraining?
 - What working contracts and activation documents were used? Who prepared them?
 - Was an adequate information and control system provided after the activation phase? If not, why not?
 - How was the project organized internally with regard to :
 - . work and task division?
 - . authority, responsibility, and supervision?
 - . communication channels among divisions and with support organizations?
 - . relationships between technical and administrative divisions?
 - . resource procurement and allocation?
 - . monitoring and reporting?
 - What types of systems or procedures were established for bidding or contracting?
 - Were the major sources of projects inputs:
 - . financial resources?
 - . materials, supplies, equipment, and facilities?
 - . manpower?
 - . political support?
 - . technology?
 - . public participation?
 - Were detailed and realistic project operation plans formulated for:
 - . budgeting?
 - . recruitment and training of personnel?
 - . data collection?
 - . work and activity scheduling?

A4.3. Operations Control and Handover

a) Operations

- How were work activities and projects scheduled?
- Did the project management team make use of such techniques as CPM and PERT analysis? What other techniques were used and why were they selected?
- Was there an adequate management information system? Did it define:
 - . information requirements?
 - . sources of information?
 - . systematic procedures and organization for collecting data?
 - . a coordinated design to integrate internal and external project activities?
- Were feedback channels and feedback elements identified? Was adequate use made of these channels? Was adequate use made of information received from these channels?
- Were formal problem-solving or troubleshooting procedures established?
- What arrangements were made for coordination of project activities with supporters, suppliers, and clients?
- What was the nature of the leadership style of the project manager during the implementation phase? Could it be characterized as:
 - . management by control?
 - . management by objectives?
 - . management by exception?
- Was the project redesigned or modified to meet unanticipated problems during implementation?

b) Supervision and Control

- Were formal systems or procedures created to:
 - . procure, inspect, and inventory at optimum levels, raw materials and other resource inputs?
 - . ensure vigorous recruitment and optimum manpower utilization as regards their efficiency and output?
 - . monitor budget performance, cash flows; forecast

- deviations from funding requirements?
- . test and adapt transferred technology?
- Were formal management techniques such as network analysis and operations research used to:
 - . provide information on project progress to constituent beneficiaries?
 - . coordinate the work of contractors?
 - . reallocate resources to behind-schedule activities?
- What methods were used to report progress and problems to authorities? What type of information was reported? How frequently were reports made? To whom were they addressed?
- How were remedial actions initiated and performed when monitoring and control procedures indicated problems?
- Did conflicts occur:
 - . between technicians from different disciplines or specializations?
 - . between administrators and technicians?
 - . between project managers within the parent organization?
 - . between the project implementation unit and other organizations?

c) Completion and Handover

- Were project completion reports prepared and reviewed?
- Was a plan prepared either for replication or for the transition of a successful experiment, pilot, or demonstration project to full-scale operation?
- What arrangements were made for diffusion of project outputs and results?
- Were replicable components of the project identified?
- Were arrangements made for follow-up investment or multiphase funding?
- Were extension or technical assistance services created to assist clients or users to adapt project output and results?
- Were the procedures and methods of handover and a continuation in an ongoing organization well established?

were they complied with? If not, why not?

- What kinds of arrangements were made to transfer unutilized or excess resources - human, financial, physical, and technical - from the project at completion to other projects or organizations?
- What arrangements were made for credit or loan repayment?
- Would levels of outside funding change considerably upon handover to an ongoing organization?
- Were project personnel reassigned to new duties at the project's completion? Were they prepared and trained for this?
- Did the handover mean that new persons took over the project activities, or were the same persons transferred to a different organizational setting?
- What restructuring or modification was required of the receiving agency or institution?
- What difficulties arose as a result of the transfer and handover:
 - . to the project team?
 - . to the receiving institutions?
 - . to the beneficiaries?
 - . to the funding agencies?

A4.4 Evaluation and Refinement

a) Evaluation and Followup

- Was the need for the evaluation adequately perceived?
- Were the objectives of the evaluation sufficiently clear?
- What type of evaluation was decided upon? Was the focus to be short-term, medium-term, or long-term effects/benefits of the project?
- Were formal evaluation procedures established? Was an evaluation timetable set up?
- What techniques were used in the evaluation (cost/benefit analysis, baseline measures, etc.)?
- Who did the evaluation? Was it an individual or a team? If a team, was it composed of individuals independent and outside of the parent institution, or of individuals from

within, or both? Why?

- What level of seniority did the evaluator(s) have?
- Was adequate background information and data provided for evaluation purposes?
- Was the evaluation team provided with adequate administrative support?
- What were the results of the evaluation? Were the intended benefits realized? If not, why not?
- Was project efficiency measured from time schedule, budget, and performance output considerations? What were the major factors causing delay, cost overruns, lack of meeting project performance criteria?
- Was variance analysis used to measure the difference between projected and actual results?
- Did the evaluation consider the appropriateness of the following aspects of the project:
 - . management information system?
 - . level of technology?
 - . operating design?
 - . manpower capabilities?
 - . organizational structures and flexibilities?
- Did the outcome of the project support the programme and national policy goals for which the project was intended and of which the project was a part?
- What was the overall impact of the project on the local, sectoral, or national setting?
- What was the prevailing attitude and reaction of the end users at the start of the project? What was it at the end? Did they perceive the project objectives in the same way?
- Did the evaluation identify unmet needs? Did the evaluation identify piggyback or followup projects?
- Did the evaluation identify replicable components of the project? Did it identify followup investment or multiphase funding?
- Did it detect unforeseen side effects of the project, whether fortunate or unfortunate ones?
- Were formal evaluation reports written up and presented?

To which individuals or agencies were they given? When?
How were they used?

- Did the project team see the reports or participate in their formulation or preparation?

b) Refinement of Policy and Planning

- Were the results of the evaluation followed up? If so, by whom and how soon afterwards? If not, why not? If so, what were the results?
- Did the evaluation results lead to the formulation of proposals for other projects? Did they lead to improvements or modifications of new policy?
- What lessons and insights were learned from the project? Was there an analysis of the reasons for deviations in implementation from the operating plan? Did the analysis reveal both long-term and short-term lessons?
- How can these lessons be applied to refine the project or future projects?
- How can these lessons be applied to future policy decisions on project management?

- o 0 o -

Bibliography

- o 0 o -



Bibliography

Agarwala, R. Planning in Developing Countries: Lessons of Experience. World Bank Staff Working Paper No. 576. 1984.

Arlosoroff, S. et al. Community Water Supply. The Hand Pumps Option. World Bank. 1987.

Auret, D. An Evaluation of the CADEC Primary Health Care Projects in the Chinhoyi Prefecture. Mashonaland. Zimbabwe. Mimeograph. June 1985.

Aziz, K M A. et al. Water Supply, Sanitation and Hygiene Education: Draft Report of a Health Impact Study in Mirzapur, Banqladesh. ICDDR. Mimeograph. 1989.

Bajard, Y. Draper, M. & Viens, P. Rural Water Supply and Related Services in Developing Countries: A Comparative Analysis of Several Approaches. Journal of Hydrology. Vol. 51. Pp. 75-88. 1981.

Bamberger, M. The Role of Community Participation in Development Planning and Project Management. EDI. Policy Seminar Report 13. Economic Development Institute. World Bank. 1988.

Bauer, T S. Equality, The Third World and Economic Delusion. London. Methuen. 1981.

Becher, E. Investments in Water Supply and Sanitation: The Cost Patterns with Policy Choice. Seminar on Developing Countries. 13th International Water Supply Congress and Exhibition. Paris. 1980.

Becher, E. The Experience with Rational Sector Studies: Identification of Constraints and Priorities. IRC Bulletin No. 10. 1976.

Behr, M. Coordinated Agricultural and Rural Development, CARD. A Discussion Paper. GTZ Masvingo. Mimeograph. January 1986.

Benor, D., Harrison, J Q, & Baxter, M. Agricultural Extension. The Training and Visit System. A World Bank Publication. 1984.

Bourne, P G. Water and Sanitation. Economic and Social Perspectives. Academic Press. Orlando. USA. 1984.

Bowden, P. How Project Assistance Adds to Third World Woes. News and Views from the World Bank. Nov/Dec. 1979.

Boydell, R A. An Evaluation of a Number of Blair Latrines, Hand Dug Wells and Drilled Boreholes in Masvingo Province. Mimeograph. Ministry of Health, Zimbabwe. 1984a.

Boydell, R A. Final Report to GTZ on the Blair Latrine Construction Project Masvingo Province. Mimeograph. Ministry of Health, Zimbabwe. 1985a.

Boydell, R A. Plan of Operation, Expanded Rural Water Supply and Sanitation Programme; Masvingo Province. Mimeograph. Ministry of Health, Zimbabwe. 1984b.

Boydell, R A. Progress Report to War on Want, Community Based Rural Water Supply and Project Serima Communal Area. Mimeograph. Ministry of Health, Zimbabwe. 1985b.

Boydell, R A. Project Proposal for a Rural Water Supply and Sanitation Pilot Project Svosve Communal Area, Mashonaland East. Mimeograph. Ministry of Health, Zimbabwe. 1985c.

Boydell, R A. Proposal to the EEC for the Extension of the Mhondoro Rural Water Supply and Project. Mimeograph. Ministry of Health, Zimbabwe. 1985d.

Boydell, R A. Proposal to GTZ for the Extension of the Blair Latrine Construction Project Masvingo Province. Mimeograph. Ministry of Health, Zimbabwe. 1986a.

Boydell, R A. The Development of a Low Cost Sanitation System for Botswana. MSc. Thesis Loughborough University of Technology. 1978.

Boydell, R A. The International Drinking Water Supply & Sanitation Decade. An Outline of Activities in Zimbabwe. Briefing Paper Prepared for a OECD Development Assistance Committee Special Meeting. Paris. May 1986b.

Boydell, R A. WHO Minimal Evaluation Procedure for Water & Sanitation Projects - A Summary & Critique. Ministry of Health Workshop on Monitoring & Evaluation of Water & Sanitation Projects. Kadoma, Zimbabwe. 1985e.

Boydell, R A., Beirring, C. & Madsen, B. A Catalogue of Agencies Contributing to the Decade in Zimbabwe. IDWSSD. UNDP, Zimbabwe. May 1985.

Boydell, R A. & Chingono, P. CADEC Water and Sanitation Project Mashonaland. Community Case Studies. Mimeograph. July 1986a.

Boydell, R A., & Chingono, P. Save The Children Fund Primary Health Care Project Binga District. Matabeleland North. Community Case Studies. Mimeograph. Sept. 1986b.

Boydell, R A., Cross, E P W. & Skoda, J. UNICEF-Assisted Well Digging Programme in Matabeleland. Evaluation Report. Volumes I & II. UNICEF Zimbabwe. Mimeograph. March 1986.

Briscoe, J. & de Ferranti, D. Water for Rural Communities. Helping People Help Themselves. World Bank. 1988.

Browne, D G. Justification and Problems of Water Master

Planning. Paper presented to The Botswana Master Plan Workshop. March 1987.

Bryer, R A. The Status of the Systems Approach. In Checkland. 1977.

Burton, I., & Lee, T R. Community Water Supply and Economic Development: The Scale of Timing and Investment. Proceedings of a Regional Workshop. Ref. CWS/WP/67.8. Geneva. WHO.

Cassen, R. et al. Does Aid Work?: Report to a Inter-governmental Task Force. Oxford University Press. 1986.

Central Statistics Office (CSO). Permanent Sample Survey Unit. Reports Nos. 1, 2, 3, 4 & 5. Demographic and Socio-Economic Survey of Communal Lands in Manicaland, Masvingo, Midlands & Mashonaland East Provinces. 1983/1984.

X Chambers, R C. Rural Development: Putting the Last First. Longman. Harlow. UK. 1983.

Chambwe, A. et al. Report on the Effectiveness of Organizational Structures in the Primary Health Care Areas of Mhondoro, Zimutu, and Serima. Ministry of Health. Zimbabwe. 1982.

Chandler, G C. Achieving Success in Community Water Supply and Sanitation Projects. WHO. SEARO. Health Paper No.9. 1985.

X Checkland, P. Systems Thinking, Systems Practice. John Wiley & Sons. Chichester. 1981.

Chenery, H. et al. Redistribution with Growth. Oxford University Press, London. 1974.

Churchill, A A. et al. Rural Water Supply and Sanitation: Time for a Change. World Bank Discussion Paper No 18. 1987.

Clausen, T J. et al. Interim Evaluation of the Rural Water Supply and Sanitation Projects in Midlands and Matabeleland North Provinces, Zimbabwe. DANIDA. Mimeograph. June 1987.

Cochrane, G. Policies for Strengthening Local Government in Developing Countries. World Bank Staff Working Paper No. 582. 1984.

Cohen, J M. Grindle, M S. & Walker, S T. Foreign Aid and Conditions Precedent: Political and Bureaucratic Dimensions. World Development. Vol. 13. No. 12. 1985.

Commission on Social Services Development. Annual Report. Zimbabwe Catholic Bishops Conference. Mimeograph. 1983.

Commission on Social Services Development. Personal interviews with Dianna Auret, Project Manager Mashonaland, between 1984 and 1987.

Cornock, J S. Understanding Supra Institutional Problems: Systems Lessons Drawn from an Application of the Checkland Methodology. Conference on Applied General Systems Research. SUNY. Binghamton. 1977.

Cummings, T G. Ed. Systems Theory for Organization Development. John Wiley and Sons. Chichester. 1980.

DANIDA. Personal interviews with staff and consultants, including; H Frotlund, Programme Officer, T J Clausen, Water Adviser and J Boesen Social Science Consultant, between 1984 and 1987.

Department of Physical Planning. Serima - A Research Project in Integrated Rural Development. Government of Zimbabwe. Mimeograph. 1982.

De Wilde, J C. Experiences with Agricultural Development in Tropical Africa. Johns Hopkins Press, Baltimore. 1967.

Donnelly-Roark, P. New Participatory Frameworks for the Design and Management of Sustainable Water and Sanitation Projects. WASH Technical Report No. 50. 1987.

Doorn, J W M Van. & Vught, F A Van. Forecasting Methods and Techniques for Future Research. (English Summary). Van Gorkum, Assen. 1978.

Doorn, J W M Van. & Vught, F A Van. Planning Methods and Techniques for Policy Making. (English Summary). Van Gorkum, Assen. 1978.

Dunets, A. (ed.). Proceedings of a Workshop on Community Wells Construction. National Action Committee for the IDWSSD, Zimbabwe. 1985.

Dunets, A. et al. Summary of the National Master Plan Review Board Meeting. Ministry of Energy and Water Resources Development. August, 1985.

Dunn, P. Appropriate Technology - Technology with a Human Face. Schocken Books. New York. 1978.

Eckaus, R S. Some Temporal Aspects of Development, A Survey. World Bank Staff Working Paper No. 626. 1984.

EEC. Guidelines for Preparation of Micro Projects. Mimeograph. Undated.

EEC. Personal interviews with R Sabah, Engineering Adviser, between 1984 and 1987.

Elmendorf, M. The Role of Women as Participants and

Beneficiaries in Water & Sanitation Programmes. WASH
Technical Report No. 11. 1984.

Emery, F E. & Trist, E L. The Causal Texture of
Organizations. In Human Relations. Vol. 18. 1965.

Esman, M. Monitoring the Progress of Projects. The Red Book
and Operations Room in Malaysia. In Rondinelli 1977.

Esman, M. Paraprofessionals in Rural Development. Issues in
Field Level Staffing for Agricultural Projects. World Bank
Staff Working Paper No. 573. 1983

Feachem, R G. et al. Evaluation for Village Water Supply
Planning. John Wiley & Sons. Chichester. UK. 1980.

Feinberg, R E. et al. Between Two Worlds: The World Bank's
Next Decade. Overseas Development Policy Perspective No. 7.
Overseas Development Council. Washington. 1985.

Ferrant, T. After the Decade. Three Strategies for
Maximising Water Supply and Sanitation Development. Article
in World Water, March 1989.

Ferrant, T. Realistic Timetable Required For Africa.
Article in World Water, June 1985.

Forss, K. et al. Evaluation of the Effectiveness of
Technical Assistance Personnel Financed by the Nordic
Countries. A Joint Review Commissioned by DANIDA, FINNIDA,
NORAD and SIDA. March 1988.

Freedom From Hunger. Personal interviews with J F Chikara,
Country Programme Director, between 1984 and 1987.

Freeman, H E. Rossi, P H. & Wright, S R. Evaluating Social
Projects in Developing Countries. Development Centre of the
OECD. 1979.

GART. Drought Relief Project and Supply of Farm Inputs, Masvingo and Manicaland Provinces. GTZ. Masvingo. 1985.

Glennie, C. A Model for the Development of a Self Help Rural Water Supply and Sanitation Programme. World Bank Technical Paper No 2. 1982.

Goodman, L J. & Love, R N. (eds.). Management of Development Projects. An International Case Study Approach. Pergamon Press. 1979.

Gorman, R F. (ed.). Private Voluntary Organizations as Agents of Development. Westview Press. 1984.

GTZ. Personal interviews with Dr U Weyl, Project Manager, R Schottke, Engineering Adviser in MEWRD, and D Stilz Consultant, between 1984 and 1987.

Haugland, K. Water Sanitation & Health [in Zimbabwe]. Report No. 21B007 prepared by HIFAB Consultants for NORAD. May 1984.

Heaver, R. Bureaucratic Politics and Incentives in the Management of Rural Development. World Bank Staff Working Paper No. 537. 1982.

Hill, C B. & Mtawali, M. Lessons from the Gravity Fed Piped Water System in Malawi. In "Successful Projects in Africa: Case Studies of Projects, Programmes and Policies". EDI. Policy Case Study Series No. 1. World Bank. 1989.

IDWSSD. Nation Action Committee, Zimbabwe. Draft Proposal for the Organization and Administration of Community Based Water and Sanitation Projects. Community Participation in Shallow Wells Seminar. Harare. May, 1984.

Imboden, N. Planning & Design of Rural Drinking Water

Projects; A Research Framework to Analyse Experiences. OECD Occasional Papers on Experiences in Rural Development. 1977.

International Reference Centre for Community Water Supply and Sanitation. The Netherlands. Practical Solutions in Drinking Water Supply and Wastes Disposal for Developing Countries. Technical Paper Series No. 20. 1982.

Jackson, J H. Morgan, C P. & Paolillo, J G P. Organization Theory: A Macro Perspective for Management. Prentice Hall. New Jersey. 1986.

Jellema, K. Dug Wells with Handpumps - Technologies that Allow Community Participation. Lutheran World Federation, Bulawayo. 1983.

Jones, L M. The Conflicting Views of Knowledge and Control Implied by Different Systems Approaches. In Checkland. 1978.

Kally, E. Determination of Water Supply Investment Priorities in Developing Countries. Journal of American Water Works Association 57. No. 8. 1965.

Korten, F F. Building National Capacity to Develop Water Users Associations. Experience from the Philippines. World Bank Staff Working Paper No. 528. 1982.

Korten. D C. Community Organization and Rural Development. A Learning Process Approach. Public Admin. Review Sept/Oct. 1980.

Lappe, F M., Collins, J. & Kinley, D. Aid as Obstacle. Twenty Questions About Our Foreign Aid and the Hungry. Institute for Food and Development Policy. 1980.

Laver, S. Development of Instructional Support Media for

Local Level Builders and Individuals Involved in Sanitation Development at Community Level. Mimeograph Report Prepared for GTZ. 1985.

Layton, J J. and Sallam, M. Experiences with Water Users Associations. EWUP Technical Report No. 65. Cairo, Egypt. 1984.

Lele, U. The Design of Rural Development, Lessons from Africa. World Bank Research Publications. 1975.

Lewis, W A. The Theory of Economic Growth. Allen and Unwin, London. 1955.

Lethem, F. and Cooper, L. Managing Project Related Technical Assistance. World Bank Staff Working Paper No. 586. 1983.

Lenneiye, N M. & Mputa, E. Report on Extension Work in Zimbabwe - Preliminary Survey. Prepared for MCDWA for Presentation to an Interministerial Primary Health Care Workshop. Mimeograph. October, 1983.

Lincklaen-Arriens, W T. & Hessing, E L P. Planning and Evaluation for Community Water Supply and Sanitation. A Literature Review and Annotated Bibliography. International Reference Centre. 1982.

Lutheran World Federation. Personal interviews with staff members, including , Wolfgang Lauer, Country Programme Director, Piet Te Velde and klaus Jellema, Project Officers, during 1985 and 1986.

Lutheran World Federation. Annual Reports for Zimbabwe. Department of World Services. 1984, 1985 & 1986.

Lutheran World Federation. Feature Report - Water Programme Zimbabwe. Department of World Services. 1982.

McNeil, D. The Contradictions of Foreign Aid. Croom Helm. London. 1981.

Masoni, V. Nongovernmental Organizations and Development. Finance and Development. September 1985.

Matindike, S S P. The Effect of Introducing Protected Wells on the Incidence of Waterborne Diseases in a Rural District - A Takawira (Chilimanzi) District Case Study. University of Zimbabwe, Harare. 1982.

Miller, D. Self Help and Popular Participation in Rural Water Schemes. OECD Development Centre. Paris. 1980.

Ministry of Energy, Water Resources & Development, Zimbabwe. Crash Borehole Drilling Programme - Mashonaland. Volumes I & II. Interconsult. December 1985.

Ministry of Energy, Water Resources & Development, Zimbabwe. National Master Plan For Rural Water Supply & Sanitation. Vols. 1 to 14. Draft Edition 1985.

Ministry of Energy, Water Resources & Development, Zimbabwe. Terms of Reference for a National Master Plan For Rural Water Supply & Sanitation. 1982.

Ministry of Energy, Water Resources & Development, Zimbabwe. Personal interviews with A Mpala and T S Mitchell Deputy Secretaries, J Holland and A Dunets Engineers, between 1984 and 1987.

Ministry of Health. Planning for Equity in Health. A Sectoral Review and Policy Statement. Government of Zimbabwe. 1981.

Ministry of Health. Personal interviews with various staff including; D Makuto, Deputy Secretary, J Mvududu, Chief Health Inspector, N Mtakwa Decade Officer. Also, Provincial

and District Health Inspectors; D Proudfoot, G Parsons, J Norde, W White, and E Hall, between 1984 and 1987.

Ministry of Lands Resettlement & Rural Development, Zimbabwe. Intensive Resettlement Policy and Procedures, Undated handbook.

Ministry of Local Government & Town Planning, Zimbabwe. Planning & Development of Growth Points & Service Centers. Paper presented at a National Action Committee Workshop, Juliasdale, Nov. 1983.

Morgan, G. Images of Organization. Sage Publications. Beverly Hills. 1986.

Morgan, P. Blair Research Bulletins for Rural Water Supply and Sanitation. Blair Research Laboratory. MOH. Zimbabwe. June, 1986.

Morgan, P. Research Officer, Blair Research Laboratory. Ministry of Health. Personal interviews between 1985 and 1987.

Mosley, P. Overseas Aid: Its Defence and Reform. Harvester Press. UK. 1987

Narozny, A. Proposal for Establishing a Maintenance System for Non Piped Water Supplies in Masvingo Province. Consultants Report. 1984.

National Action Committee for the International Drinking Water supply & Sanitation Decade, Zimbabwe. Ministry & Agency Roles in Water & Sanitation. Proceedings of a workshop held in Juliasdale, Zimbabwe, Nov. 1983.

Naughton, J. The Checkland Methodology: A Readers Guide. Open University Systems Group. Milton Keynes. 1977.

NORAD. Personal interviews with staff and consultants including; C Haugland and M H Gleditsch, HQ programme staff, A Kruger and F Carlsen, engineering advisers in MEWRD, S Stoveland, Masterplan Coordinator MLGRUD, K Haugland and T Lium, consultants, between 1984 and 1987,

NORAD. Plan of Operation for NORAD Assistance to the Government of Zimbabwe for Rural Water Supply and Sanitation Activities, July 1987 to June 1988. Mimeograph. 1986

Oakley, P. & Marsden, D. Approaches to Participation in Rural Development. ILO. Geneva. 1984

Okun, D A. The Community Water Supply Programme of the Agency for International Development. United States Department of State. Washington. 1965.

Oosting, A P. Lutheran World Federation Water Programme in Zimbabwe. Blasting in Wells. Mimeograph. 1983.

Pacy, A. Rural Sanitation Planning and Appraisal. An Oxfam Document. Intermediate Technology Publications. 1980.

Paul, S. Strategic Management of Development Programmes; Guidelines for Action. ILO Management Development Series No. 19. 1986.

Perrett, H. Social Feasibility Analysis for Low-cost Sanitation Projects. TAG Technical Note TN 01. UNDP Project INT/81/047. 1984.

Perrett, H. Using Communications Support in Projects. World Bank Staff Working Paper No. 551. 1982.

Practical Concepts Incorporated. The Logical Framework - A Managers Guide to a Scientific Approach to Design & Evaluation. Washington DC. USA. 1969.

Prevost, P. Soft Systems Methodology, Functionalism and the Social Sciences. In Checkland. 1976.

Raabe, C. et al. Evaluation Study of the Impact of German Technical Cooperation Projects in Rural Development and the General Life Situation of Women. A Case Study of the GART Activities in Masvingo, Zimbabwe. BMZ. Bonn. FRG. 1986.

Republic of Zimbabwe. First Five Year National Development Plan. 1986 - 1990. Volume I. April 1986.

Republic of Zimbabwe. First Five Year National Development Plan. 1986 - 1990. Volume II. April 1988.

Republic of Zimbabwe. Growth with Equity: A Policy Statement. MFEDP. 1981.

Republic of Zimbabwe. Three Year Transitional National Development Plan. 1983 -1985. Volume I. November 1982.

X Rondinelli, D A. Development Projects as Policy Experiments. An Adaptive Approach to Development Administration. Methuen. New York. 1983.

Rondinelli, D A. (ed.) Planning Development Projects. Hutchinson & Ross. Stroudsberg USA. 1977.

Roth, G. The Private Provision of Public Service in Developing Countries. EDI Series in Economic Development. Oxford University Press. 1987.

Rybczynski, W. Polprasert, C. and McGarry, M. Low Cost Technology Options for Sanitation. A State of the Art Review and Annotated Bibliography. International Research Centre, Canada. 1978.

St. Theresa's Mission. Personal interviews with Sister Patrisha Walsh, Brother Charles and Doctor P Morgan, 1985.

Salaman, G. Working. Tavistock. London. 1986.

Salmen, L F. Listen to the People. Participant Observer Evaluation of Development Projects. A World Bank Publication. Oxford University Press. 1987.

Samset, K F. & Lennieye, N M. Community Participation in Water and Sanitation Programmes. The Role of the Ministry of Community Development and Womens Affairs. Report Prepared for NORAD. 1987.

Saunders, J. & Warford, R. Village Water Supply - Economics and Policy in the Developing World. World Bank. 1976.

Save the Children Fund, UK. Strategy on Community Participation in Well Construction. Mimeograph. July 1986.

Save the Children Fund UK. Personal interviews with staff, including S Metcalfe, Country Programme Director, T Skitt and J Sturgeon, Project Officers, between 1984 and 1987.

Schonborg, R. Water Master Planning Coordination Unit, Objectives, Strategies and Perspectives. Proceedings of Seminar on Water Master Planning in Developing Countries. Bolkesjo, Norway. 1983.

Schumacher, H. Small is Beautiful. Economics as if People Mattered. Harper, New York. 1975.

SIDA. Personal interviews with staff and consultants including; O Jamtin, and L Boberg Programme Officers and B Rubenson, Consultant, between 1984 and 1987.

Simpson-Herbert, M. Methods of Gathering Socio-cultural Data for Water and Sanitation Projects. TAG Technical Note TN 01. UNDP Project INT/81/047. 1984.

Skitt, T. Evaluation of a Water and Sanitation Pilot Project in Mhondoro and Ngezi Communal Lands, Zimbabwe. MSc Thesis. Imperial College. University of London. 1985.

Smith, W E, et al. Design of Organizations for Rural Development Projects. World Bank Staff Working Paper No. 375. 1980.

Staveren, J M van. & Dusseldorp, D B W van. (eds.) Framework for Regional Planning in Developing Countries. A Methodology for an Interdisciplinary Approach to the Phased Development of Predominantly Rural Areas. ILRI. Publication No.26. Wageningen. 1981.

Stewart, F. Technology and Underdevelopment. Westview Press, Boulder USA. 1977.

Stewart Scott & Partners. Draft Plan of Operation for a Wells Construction Programme, Masvingo Province. Consultants Report. 1984.

Stilz, D. & Weyl, U. A Model of an Ecology Oriented Agricultural Development Programme and its Transformation into an Attack on Rural Poverty Exemplified in Gutu District, Masvingo, Zimbabwe. Facharbeit Geographie. Universitat Osnabruck. August 1986.

Strauss, M. The Community Water Supply and Sanitation Programme of the Western Development Region of Nepal. IRCWD News. 1983.

Streeten, P. et al. First Things First. Meeting Basic Human Needs in Developing Countries. World Bank Publication. 1981.

Te Velde, P. Lutheran World Federation. Organization and Implementation of a Dug Wells Programme. 9th WEDC

Water Supply and Sanitation Programme in Manicaland. Status Report. 1987.

Vogel, A J. Recent IDWSSD Planning Efforts and Major Constraints. Proceedings of Seminar on Water Master Planning in Developing Countries. Bolkesjo, Norway. 1983.

Vogel, A J. et al. Zimbabwe Rural Water Supply & Sanitation Sector Study. World Health Organization, World Bank Cooperative Programme. 1981.

Voluntary Fund for the UN. Decade for Women. A Guide to Community Revolving Funds. 1982.

Wall-Bake, W. Ahlberg, P. & Carlsson, L. Norad's Profile in Zimbabwe's Rural Water Supply and Sanitation Sector, A Choice of Strategy. Open letter to the Norwegian Ambassador. 1987.

Walsh, Sr. P. Community Water Supply Project, St. Theresa's Mission Zimbabwe. 11th WEDC Conference; Water & Sanitation in Africa. Dar es Salaam. 1985.

Walters, R S. American and Soviet Aid: A Comparative Analysis. University of Pittsberg Press. 1970.

Warner, D B. et al. PVO Effectiveness in the Water and Sanitation Sector. WASH Field Report No. 183. 1986.

White, A. Community Participation in Water & Sanitation. Concepts Strategies & Methods. IRC Publication TP17 .1981.

White, J. The Politics of Foreign Aid. London. Bodley Head. 1974.

Whyte, A. Guide for the Design of a National Support Programme for Community Education & Participation in Water Supply & Sanitation. IRC Draft. Mimeograph. 1980.

Conference. Water and Sanitation for Development in Africa. Harare, 1983.

Therkilsen, O. Watering White Elephants. Lessons from Donor Funded Planning and Implementation of Rural Water Supplies in Tanzania. Scandinavian Institute for African Studies. 1988.

UNICEF. Country Programme - Zimbabwe. Programme Committee Session. New York. 1983.

UNICEF. Personal Interviews with staff, including D F Williams, Project Officer, and M Hapte Mariam, Programme Officer, between 1984 and 1987

United Nations Economic & Social Council. Progress Report on the Mar del Plata Plan in Africa. Report E/ECA/CM. 1985.

United Nations Secretary General. The Progress of the International Drinking Water Supply & Sanitation Decade. Report to the General Assembly. 11 April 1985.

University of Zimbabwe. Department of Land Management. Environmental Study of the Sabi Valley, Manicaland. 1982.

Van Wijk-Sijbesma, C. Participation & Education in Community Water & Sanitation Programmes. A Selected Bibliography. WHO IRC Bulletin No. 13. 1979.

Van Wijk-Sijbesma, C. Participation of Women in Water Supply and Sanitation, Roles And Realities. WHO IRC Technical Paper No. 22. September 1985

Vespa, R. Implementation: The Problem of Achieving Results. In Rondinelli 1977.

Viak Consulting Engineers. Review of SIDA Funded Rural

World Bank. World Development Report, 1987. Oxford University Press. 1987.

World Bank. Zimbabwe Country Economic Memorandum. 1981b.

World Health Organization. Drinking Water and Sanitation 1981 - 1990. A Way to Health. 1981a.

World Health Organization. International Drinking Water & Sanitation Decade. National Decade Plans: Eight Questions They Answer. Geneva. 1982a.

World Health Organization. International Drinking Water & Sanitation Decade. Manual for Planners. ETS Series. Geneva. 1981b.

World Health Organization. Minimum Evaluation Procedure for Water & Sanitation Projects. Reference ETS/83.1. CDD/OPR/83.1. Geneva. 1983a.

World Health Organization. Rural Water Supply Operations and Maintenance - Eight Questions to Ask. ETS/83.9. Geneva. 1983b.

World Health Organization. Techniques for the Collection and Reporting of Data on Community Water Supply. Report of a WHO Scientific Group. WHO Technical Report Series No. 490. Geneva. 1982b.

World Health Organization. Towards the Targets (an overview of progress in the first five years of the IDWSSD). Reference WHO/CWS/88.2. April 1988.

World Health Organization & UNICEF. Primary Health Care. A Joint Report of an International Conference on Primary Health Care held in Alma Ata, Kazakhstan. Geneva, New York. 1978.

Whyte, A. Guidelines for Planning Community Participation Activities in Water Supply and Sanitation Projects. WHO. Geneva. 1986.

Whyte, A. Towards a User Choice Philosophy in Rural Water Supply Programmes. In UNICEF Assignment Children No. 34. Geneva. 1976.

Williams, D F. A Proposed Strategy for the Maintenance of Hand Pumps. Mimeograph. Ministry of Local Government, Rural & Urban Development. UNICEF/DDF. 1986.

Williams, D F. Community Well Digging in Zimbabwe. 11th WEDC Conference; Water & Sanitation in Africa. Dar es Salaam. 1985.

Williams, D F. Project Proposal for UNICEF Duq Well Programme in the Communal Lands of Matabeleland. Mimeograph. UNICEF Zimbabwe. 1982.

Wood, G. (ed.). Labelling in Development Policy. Essays in Honour of Bernard Schaffer. Sage. London. 1985.

World Bank. Operations Evaluation Department. Rural Development - World Bank Experience 1965 to 1986. 1988.

World Bank. Poverty and Human Development. Oxford University Press. 1980.

World Bank. Rural Development Sector Policy Paper. 1975.

World Bank. Social Infrastructure and Services in Zimbabwe. Staff Working Paper No. 495. 1981a.

World Bank. Village Water Supply. A World Bank Paper. 1976.

Yin, R K. Case Study Research: Design and Methods. Applied Social Research Methods Series No. 5. Sage Publications. 1984.

11/11/11

11/11/11

