

73

ESCAP 76

# Proceedings of the meeting of the Expert Working Group on the Use of Solar and Wind Energy

Energy Resources  
Development Series No. 3



UNITED NATIONS

73 ESCAP 76  
1161.4

The designations employed and the presentation of material in this publication do not imply the expression of any opinion whatsoever on the part of the Secretariat of the United Nations concerning the legal status of any country, territory, city or area or of its authorities, or concerning the delimitation of its frontiers or boundaries. The mention of any commercial firm, industrial enterprise or licensed process in this publication does not imply endorsement by the United Nations.

VI. 161.4

73  
ESCAP 76

**ECONOMIC AND SOCIAL COMMISSION  
FOR ASIA AND THE PACIFIC**  
Bangkok, Thailand

# **PROCEEDINGS OF THE MEETING OF THE EXPERT WORKING GROUP ON THE USE OF SOLAR AND WIND ENERGY**

**ENERGY RESOURCES DEVELOPMENT SERIES**

**No. 16**



**UNITED NATIONS**  
New York, 1976

For sale by the United Nations  
Sales Office, New York, N.Y. 10017  
or by the United Nations  
Sales Office, Geneva, Switzerland

ST/ESCAP/7

UNITED NATIONS PUBLICATION

Sales No.: E.76.II.F.13

Price: \$US 9.00 or equivalent in other currencies



## FOREWORD

This publication contains the report and documents of the meeting of the Expert Working Group on the Use of Solar and Wind Energy (2-9 March 1976), held, as part of the continuing programme on the utilization of non-conventional energy resources, by the United Nations Economic and Social Commission for Asia and the Pacific (ESCAP) at Bangkok, Thailand, with the financial assistance of the United Nations Development Programme (UNDP).

It consists of four parts. Part one includes the report of the meeting. Parts two, three and four contain technical documents, presented by the secretariat and contributed by the experts, on solar energy, wind energy and integrated systems utilizing solar and/or wind devices, respectively.

Owing to limitations of space and budget, it has not been possible to reproduce all the papers contributed by the experts in full; some papers have been abridged, and selected information given in the papers has been collated and re-presented.



**Part Three**

**DOCUMENTATION ON WIND ENERGY**

	<i>Page</i>
I. Working papers presented by the secretariat	
Development of wind energy utilization in Asia and the Pacific .. .. .	61
The design and construction of low-cost wind-powered water pumping systems .. .. .	76
II. Information papers prepared by participants	
A review of efforts made in India for wind power utilization .. .. .	105
Research, development and use of wind energy in Thailand .. .. .	108
The utilization of wind energy in Australia .. .. .	115
A review of renewable energy in New Zealand with emphasis on wind power utilization .. ..	117
Windpower studies in Korea .. .. .	121
Research and prospects of wind energy utilization in Indonesia .. .. .	125
III. Consolidated list of references on wind energy .. .. .	130
IV. Organizations concerned with wind energy .. .. .	134

**Part Four**

**DOCUMENTATION ON INTEGRATED SYSTEMS**

I. Working paper presented by the secretariat	
An introduction to integrated solar-wind systems .. .. .	139
II. Information paper prepared by participant	
Planning for small-scale use of renewable energy sources in Fiji .. .. .	144
III. Consolidated list of references on integrated systems .. .. .	147

**Part One**

**REPORT OF THE MEETING**

## I. INTRODUCTION

### *Background and objectives of the Expert Working Group*

The ESCAP programme on energy involves two main streams of activity—a long-term programme involving the co-ordinated planning of the investigation, development and management of energy resources, and a short-term programme aimed at accelerated development of selected non-conventional energy resources with emphasis on the needs of rural areas. The latter programme was initiated in December 1974, with a reconnaissance mission to 14 developing countries to make a preliminary assessment of energy programmes and needs, and was completed in September 1975. Two workshops on the technology and utilization of bio-gas were also completed in 1975.

The other component of the programme involves solar and wind energy, under which the original plan to provide advisory services to developing countries was changed to arranging an expert working group when the reconnaissance mission indicated that a great deal of research and development had been undertaken in a number of member countries in the region. In view of the significant interactions between solar energy and wind energy, it was decided to arrange one expert working group on those two topics. Participants would comprise mainly experts selected from countries which were known to have considerable experience in either or both of the two fields, but some experts from outside the region were also included.

The objectives of the meeting were to identify the existing technology and devices for the use of solar and wind energy which could be recommended for immediate application, mainly but not exclusively in rural areas, and to recommend research and development activities likely to yield practical results in the short term, so as to improve the use of those resources. It was also intended to issue a publication setting out guidelines for the use of solar and wind energy in the variety of situations considered by the Working Group. With the financial support of UNDP, the Working Group was held from 2 to 9 March 1976 at Bangkok.

### *Attendance*

The meeting was attended by 23 experts from 13 countries, as listed in annex IV.

### *Opening address*

In his opening address, Mr. J. B. P. Maramis, Executive Secretary, stressed the importance of the meeting in the context of the decisions of the sixth

and seventh special sessions of the General Assembly and those of the Commission, particularly at its thirty-first session in 1975, all of which emphasized the need to develop scientific and technological co-operation in all sectors of development activity. He referred to the ESCAP programme in the energy field and the background of the Expert Working Group, and stressed that the Group had been arranged to make the best use of the extensive knowledge and experience available within the region on the use of solar and wind energy. At the same time it was pleasing to have the participation of some experts from outside the region.

Since the majority of the population in the developing countries of the ESCAP region lived in rural areas, the main objective of those activities was to foster the small-scale and medium-scale development of those non-commercial but renewable forms of energy in rural areas. Following the Expert Working Group meeting, it was intended to organize in 1977 a roving seminar on rural energy development under which a small team would spend about three weeks in each of the interested countries to assist in the development of practical measures to improve the availability of energy in rural areas. That would include consideration of bio-gas, solar and wind energy, rural electrification and mini-hydroelectricity.

In the light of those objectives, the Expert Working Group had before it an important task which, although related specifically to solar and wind energy, would contribute to integrated energy development programmes in regional countries in a more comprehensive way. He expressed confidence that the recommendations to be put forward by the Working Group would be so specific and practical that they could be considered for immediate implementation by the ESCAP member countries.

### *Election of officers*

Mr. R. V. Dunkle, Chief Research Scientist, Division of Mechanical Engineering, Commonwealth Scientific and Industrial Research Organization, Australia, was elected Chairman and Mr. Prapath Premmani, Director of the Technical Division, National Energy Administration, Thailand, was elected Vice-Chairman.

Mr. C. L. Gupta, Professor, Applied Science Group, Sri Aurobindo International Centre of Education, Pondicherry, India, was elected Moderator for the Solar Energy Sectoral Group and Mr. R. E. Chilcott, Lincoln College, Canterbury, New Zealand, was elected Moderator for the Wind Energy Sectoral Group.

*Agenda*

The Expert Working Group adopted the following agenda:

1. Opening address
2. Election of officers
3. Adoption of the agenda
4. Presentation of summaries of the consultants' and participants' papers
5. Group discussions
  - (a) Solar energy sectoral group
    - (i) Small- and medium-scale thermal applications; design, construction, operation, socio-economic aspects, further research and development, and recommendations: water heating, distillation, cooking, drying, refrigeration and air-conditioning, pumping
    - (ii) Promising fields of application and research and development
      - Small and medium-scale conversion to electrical and mechanical power
      - Large-scale power production by photovoltaic and photothermal devices
      - Other fields: high temperature furnace, solar house, greenhouse, algal pond
      - Recommendations
    - (iii) Solar energy characteristics, measurements and data evaluation, recommendations
    - (iv) Recommended actions, and priorities
    - (v) Adoption of the report
  - (b) Wind energy sectoral group
    - (i) Demands for and limitations in use of wind energy

- (ii) Evaluation of local environmental determinants
- (iii) Water pumping systems: available designs, capabilities, constraints, recommendations
- (iv) Electricity generating systems: available designs, capabilities, constraints, recommendations
- (v) Analysis of basic components: rotor, hub shaft, bearings, tower, control mechanisms, power transfer mechanisms, power utilization devices, storage; recommendations on hybrid designs
- (vi) Other uses and advanced concepts requiring research and development
- (vii) Recommended actions and priorities
- (viii) Adoption of the report
- (c) Discussion of solar/wind interactions
  - (i) Uses where either is appropriate
  - (ii) Integrated uses
  - (iii) Recommended actions and priorities
  - (iv) Adoption of the report
6. Consideration of reports and formulation of recommendations by the Working Group
7. Adoption of the report of the Working Group

*Organization of work*

As a background for consideration of the two main topics, the papers which had been prepared by the consultants and participants were presented in summary by the authors. Those papers are listed in annex V. The substance of those papers was considered in detail in sectoral group meetings.

The programme of meetings included field trips to the Asian Institute of Technology, to salt farms (wind-mill-pumps) in Samut Songkram province and to Samut Prakarn (windmills).

## II. DISCUSSION, CONCLUSIONS AND RECOMMENDATIONS

Members of the Working Group, meeting both in sectoral groups and in plenary meetings, had in mind a number of considerations which influenced their thinking on programmes associated with solar and wind energy. The principal considerations are summarized below.

Increased availability of energy was an important factor in any effort to improve the well-being of the rural poor, who comprised a large sector in the total population of the region. While manual labour was likely to remain a significant component in most countries of the region, other forms of energy were needed to avoid drudgery, increase productivity and improve the quality of life. There was an over-all need for an increase in the availability of energy *per capita*. The benefits from improved energy supplies were often difficult to measure in strictly economic terms, but there were generally large social benefits associated with such developments as provision of adequate lighting, improved water supply or crop-drying facilities.

Rural areas were often the most costly and difficult to supply with conventional energy forms, whereas non-conventional forms of energy, including solar and wind energy, were not necessarily subject to the same constraints. The development of those energy forms had the advantage of aiding decentralization and self-sufficiency in rural communities. Generally, however, solar and wind energy were available only intermittently, so that there was an incentive for integration with other energy forms, conventional as well as non-conventional. Thus, there was a need for integration of planning for the development of non-conventional energy resources in rural areas, in over-all national energy planning.

Because the problems in terms of human need and energy deficiency tended to be greater in rural areas, the emphasis should be on meeting the needs of those areas. However, solar and wind energy could also play useful roles in contributing to meeting energy requirements in urban and metropolitan areas in appropriate circumstances.

It was important that any devices and systems intended for widespread application in rural communities should be simple and rugged, and make the best use of locally available materials and skills. Involvement of local people as far as feasible improved the prospects for acceptability and had a variety of significant supplementary benefits.

In addition to improving living conditions, the use of solar and wind energy, if properly designed and

managed, had no significant environmental disadvantages.

Many solar and wind energy devices currently available tended to be capital-intensive, thus restricting their widespread application. Their potential value, however, was such that high priority should be given to carefully selected and managed programmes aimed at reducing costs and extending the use of those energy resources.

The Working Group in plenary session endorsed the reports of the three Sectoral Groups and the detailed recommendations made, as given in annexes I, II and III. Based on those recommendations, the Working Group put forward a number of proposals in different areas of activity.

### *National planning and surveys*

National energy planning should take into account the availability of renewable resources and their development to complement any existing energy systems.

Energy surveys should be carried out and should include assessment of:

- (a) Solar and wind energy (and bio-mass where applicable);
- (b) Energy needs of rural areas to achieve a reasonable quality of life.

National meteorological networks should be strengthened to bring solar radiation and wind measurements to at least the World Meteorological Organization (WMO) standards.

### *Research and development*

Research and development by and for the respective countries of the region should be encouraged and promoted with particular reference to selected solar devices (recommendation No. 7 (c) of annex I), wind-powered pumps and electric units (recommendation No. 8 of annex II), and integrated solar-wind uses (recommendation No. 2 of annex III). Efforts should also be made to stimulate commercial and industrial involvement in research and development projects in those fields.

### *Training*

ESCAP should initiate and encourage training in the fields of solar and wind energy use at various levels, seeking support from international agencies and countries outside the region as appropriate:

(a) At universities and technological institutions in the region, by assistance in development of courses and text materials, and provision of fellowships;

(b) By further expert technical meetings, and roving seminars, at intervals as appropriate;

(c) By assisting countries to produce texts and illustrated material for use in schools and extension services.

#### *Demonstration units*

ESCAP should encourage the setting up in selected locations of demonstrations of selected solar and wind energy utilization devices, in separate and in integrated systems, for the purposes of providing information for potential users, ensuring the necessary system reliability under normal conditions and obtaining socio-economic data needed for local and commercial development (recommendations Nos. 7 (a) and (b) of annex I, recommendation No. 16 of annex II, and recommendation No. 3 of annex III).

#### *Research directory*

A regional directory of research institutions and organizations engaged in work on renewable energy sources should be compiled and published. The directory should include research programmes and personnel, and sources of commercially available hardware.

#### *Documentation*

A regional documentation and dissemination centre on solar and wind energy technologies should be established, preferably at an existing library or technological institution within the region.

#### *Guide-books*

Technical guide-books on the design of solar and wind energy utilization devices should be compiled and published in a format appropriate for use by development workers and field extension agents. The guide-books should include sufficient information for the design and construction of those devices by local workers.

## Annex I

### REPORT OF THE SOLAR ENERGY SECTORAL GROUP

#### *Solar water-heating*

The Group noted that domestic solar water-heaters were currently within the reach of affluent people in the developing countries, and, in appropriate circumstances, could provide energy more economically than conventional energy forms. Reliable designs in the region were commercially available from Australia, India, Japan and New Zealand.

With respect to urban and metropolitan areas, heating of water for industrial as well as domestic use should be explored further.

There was scope for solar water-heating, particularly in rural areas, for community use, such as for health centres, tourist hotels and hostels, and for some cottage industries. Solar energy could also be used more extensively for heating slurry of bio-gas plants.

The Group suggested that the following action be taken in order to foster the development of solar water-heaters:

(a) Selection of appropriate locations and conditions for installation of demonstration plants;

(b) Design of water-heating systems to take advantage of the most cost-effective collector panels;

(c) Demonstration of selected systems for the purpose of providing information for potential users,

ensuring the necessary system reliability, and obtaining socio-economic data needed for commercial development;

(d) Dissemination of information and feedback of the experience among regional countries.

Research and development should be undertaken on the following aspects:

(a) Use of locally available material and skills;

(b) Building up of criteria for socio-economic viability of solar water-heating;

(c) Solar water-heating system for multiple uses, for example, combined solar water-heating and solar stills and integration of roof and collector systems.

#### *Solar distillation*

The Group considered the application of solar distillation mainly for two purposes, one for producing potable water and the other for providing distilled water for other uses. It reviewed the current status of solar distillation development, and the experience developed, in the region.

Solar stills were being used to provide drinking water for domestic use in some low-rainfall areas and isolated areas, such as salt farms, light-houses, and villages where fresh water was not available.



Solar stills had also proved to be cost-effective in certain circumstances for providing distilled water for use in garages, workshops, laboratories and health centres, and should be promoted for the developing countries of the region.

Nevertheless, solar stills were satisfactory only in special circumstances, and there was a need for further research and development with a view to widening their applicability and use, particularly by reducing operational cost and maintenance.

#### *Solar cooking*

The Group considered that solar cooking hardware could be classified in three main types: (a) solar steam cooker which only boils but cooking can be done inside; (b) solar hot box which can boil and bake but needs occasional tracking, although no continuous attendance is required; (c) reflector type cooker which can bake, boil and roast but needs tracking and attendance.

The discussion revealed that, within the region, there was little experience in the field of solar cooking except in India. However, it was felt that there could be scope for greater use of solar cookers of types (a) or (b) for which proven designs were available, in situations where other forms of energy were not readily available or not reliable, and the cost was not prohibitive.

Research and development were needed to reduce the cost of cookers and to develop designs involving storage or auxiliary heating in order to increase the reliability of the cooker, extend the cooking time and allow indoor cooking.

#### *Solar drying*

The Group noted that there was considerable experience in the use of solar drying in the region, ranging from small-scale cabinet driers to sophisticated systems incorporating storage, automatic control and auxiliary power. The availability of radiation during the wet season in most of the southeast Asian countries appeared to offer scope for more extensive use of solar drying.

The Group recommended that demonstrations be arranged of solar convective driers for drying of grains in multiple-cropping systems and for cash crops, such as cashew nut, copra, pepper and tea, and for timber where other fuels were currently used.

In forced-draft systems, research and development were needed to develop autonomous systems which could replace power-operated blowers by thermal chimneys, windmills or manual pedalling.

With respect to natural solar drying, existing practices should be studied with a view to improving the performance and the quality of the product.

#### *Solar pumping*

Considerable interest was expressed in the potential for use of solar energy for pumping. Reference was made to two systems:

(a) The solar thermal system; and

(b) Using solar cells to produce electricity to drive electrically-powered pumps.

Electricity conversion was discussed later.

With regard to the solar thermal system, it was noted that technological solutions were already available, although the cost was high. It was also noted that research and development were being carried out in the region, particularly for low-lift pumping, which seemed promising.

Developmental trials of existing solar thermal pumps of about 1 kW that were available commercially outside the region should be undertaken in order to determine their techno-economic feasibility in the countries of the region.

Research and development were needed to develop economic prototype solar pumping systems, based preferably on flat-plate collectors and stationary concentrators, servicing farm units of about 1 hectare each.

#### *Solar refrigeration*

The Group considered that there was a widespread need for ice and/or cold storage for various purposes in rural areas. Use of solar energy was technically feasible, but the economics were not known. Research and development were needed to determine the applicability of solar energy for that purpose.

#### *Space heating and cooling*

The Group emphasized the importance of care in building design and selection of materials with a view to minimizing heating and cooling requirements.

Solar heating could be promoted in some colder parts of the region, using systems based on solar collectors which were already available for heating liquids or air.

Space cooling with solar collectors was also technically feasible, but the outlook for its application in developing countries was not promising. Its combination with space heating, which was being pursued in some countries of the region, could improve its viability.

"Passive" heating and cooling, incorporating for instance roof pools, heat storage elements and panels designed to allow controlled movement of heat (thermal diodes), appeared to have considerable promise in the drier parts of the region. Work being carried out in Australia and India should be encouraged.

In the humid tropics, the outlook for passive cooling systems was not promising, and emphasis should be on architectural design.

A handbook of data to assist in the thermal design of houses, and solar heating and cooling systems, should be compiled.

#### *Solar energy conversion to electrical and mechanical power*

The Group considered solar power systems of the following scales:

Small-scale : 100 W to 2 kW

(Individual houses, farms, workshops)

Medium-scale : 20 kW to 100 kW

(Village power supply)

Large-scale : 200 kW to 1 MW and above

(Power for small industries, small town power supply)

For small-scale power requirements, photovoltaic direct conversion systems using 5 to 8 W solar cells which were available in the region had proved successful in isolated localities in Pakistan. In order to reduce costs, research and development were needed to develop new system components, including cells, concentrators, controlling devices and cooling systems. There might be scope for heating water with the coolant.

In the absence of experience within the region for medium-scale power production, developmental trials for imported solar/thermal units from outside the region could be conducted in order to determine viability under different conditions.

For large-scale power production, base-line system studies should be carried out only after some experience on the medium-scale system had been gained.

#### *Photosynthesis (bio-mass)*

While the matter was not examined in detail, attention was drawn to the potential for energy production from waste organic materials and from "energy plantations."

#### *Solar evaporation*

The Group noted that solar evaporation of solutions for salt recovery and concentration of waste liquids represented a significant major use of solar energy.

#### *Solar ponds*

Research and development for solar ponds could be carried out as a long-term programme, using bittern (mother liquor of salt production) from a salt farm. The solar pond might be used for thermal collection and energy storage, and for the recovery of valuable chemicals.

#### *Greenhouses*

The technology for greenhouses was well established in colder parts of the region. Research and development were needed for inexpensive heat storage and the reduction of heat losses.

#### *Solar radiation measurement and data evaluation*

The networks of solar radiation stations in countries of the region should be strengthened, using the standards laid down by WMO.

A regional solar radiation data book with specific reference to the utilization of solar energy should be compiled.

### **Recommendations**

The following recommendations were made:

1. Surveys of energy availability and requirements should be carried out in representative rural communities in the countries of the region. Available data should be published.
2. A handbook of solar radiation data should be compiled for the region, based on available records. The data should be specific to solar energy utilization, including conversion factors for optimum tilted surfaces, solar positions, frequency analysis etc.
3. A handbook of data to assist thermal design of houses and heating and cooling systems should be compiled.
4. The networks of solar radiation stations in countries of the region should be strengthened, using the standards laid down by WMO.
5. To assist collaborative efforts in this field, exchange of information and personnel and the planning of non-conventional energy programmes, ESCAP should publish a regional directory of personnel.

institutions, research programmes and commercially available hardware. This directory should contain references to directories available for other parts of the world and also the literature on energy bibliographies. Updating supplements should be provided biennially.

6. In view of the needs and socio-economic priorities, as well as the current state of solar technology and trends for the future, work on research, development and demonstration for and by the developing countries of the region should preferably be grouped according to the following priorities:

Priority I: Crop drying, water pumping, small-scale electricity generation, solar-assisted bio-gas generators;

Priority II: Distillation, water-heaters, passive heating systems, passive cooling systems;

Priority III: Refrigeration, cooking, active heating systems, active cooling systems.

7. The specific research and development work required in each of these areas as well as the demonstration/developmental trials required for promoting immediate applications are stated below:

(a) *Demonstration trials* are required in the following priority areas to promote immediate application of available solar technology within the region:

- (i) Solar convective driers for grains in multiple-cropping systems and for cash crops;
- (ii) Solar water-heating systems for community uses, such as health centres, tourist hotels, hostels, cottage industries and heating of bio-gas plants in rural areas.

(b) *Evaluation trials* are required in the following to introduce and test the viability of solar technology available outside the region for priority needs within the region:

- (i) Solar thermal pumps of 1 kW size;
- (ii) Solar thermal power stations of 20 to 100 kW size for electrification at village level.

The chosen sites should not only be suitable climatically but should represent the possibility of economically and environmentally satisfactory solutions.

(c) *Research and development* are required prior to application of potentially available technology for the following:

- (i) Autonomous drying systems;
- (ii) Solar pumping system for 1 hectare size farms, primarily based on flat-plate collectors and stationary concentrators;
- (iii) Systems and components for 100 W — 2 kW small-scale power, using direct photovoltaic conversion;
- (iv) Development of criteria for socio-economic viability and relevance of specific uses of solar energy;
- (v) Multiple use and architecturally integrated solar water-heating systems;
- (vi) Reduction of maintenance and operational problems of solar stills;
- (vii) Integration of optimized building design with passive heating/cooling systems in buildings;
- (viii) Economic viability of solar refrigeration for proven needs of ice or cold storage in rural areas;
- (ix) Reliable cookers which would cook indoors and do not need continuous attention;
- (x) Inexpensive thermal storage in greenhouses;
- (xi) Use of bittern from salt farms for solar ponds.

8. Countries of the region in the initial stages of solar energy research work should be assisted with the provision of training fellowships, seminars, workshops and advisory services.

9. The Group recommended that ESCAP take an immediate lead in organizing short-term courses in the region on the application of solar-energy devices for domestic and commercial buildings and for agricultural and industrial uses.

10. The Group recommended that countries produce attractive and well-illustrated material on the basics and applications of solar energy, for secondary schools. That would probably be the best way to create intelligent awareness as well as provide future sources of trained personnel for solar energy work.

## Annex II

### REPORT OF THE WIND ENERGY SECTORAL GROUP

#### 1. Limitations in the use of wind energy .

It was agreed that, for preliminary design purposes, it was appropriate to use an approximate formula such as:

$$\begin{aligned} \text{Useful power output per unit swept area} \\ = 0.1 v^3 \text{ watts/m}^2, \end{aligned}$$

where  $v$  = instantaneous wind velocity in m/sec

That formula included the Betz aerodynamic, mechanical and hydraulic or electrical efficiencies.

In estimating the actual energy output, it was necessary to know the average wind speed over the desired period and the hourly wind speed frequency curve.

It was considered that the existing international practice of hourly wind data collection was adequate, provided the anemometer height was 10 m above ground level. In places where insufficient wind data were available, interpolation techniques for correlating short-term measurement at the site with the complete data of a nearby standard meteorological installation were suggested. In places where no wind data were available, it was suggested that portable anemometers might be used for a first assessment of wind power potential, supplemented by qualitative information obtained by local enquiry. Need was expressed for simple, cheap and reliable anemometers, such as those being developed in New Zealand. It was pointed out that the maximum gust speed was a significant design criterion for survival.

It was recognized that an important consideration in the use of wind energy was to be able to supply a given quantity of energy of given quality during stated periods with a known probability level, and it might not be necessary to endeavour to provide continuous supplies of energy. It was emphasized that the determination of rated wind speed depended on the mode of utilization, i.e. whether maximum energy output or maximum reliability was required. In practice, there would generally be a compromise solution which would involve cost considerations.

The over-all economic evaluation of wind power utilization should consider capital cost, interest rate, foreign exchange, depreciation, inflation, maintenance, local materials and operation costs, related to the options available for each situation.

#### 2. Local environmental determinants

It was noted that, for most development projects, classical economic evaluation criteria were not likely to be applicable to wind energy utilization at the village level, where local material and labour might be freely available, or where a small input of energy might result in a significant social impact; socio-economic considerations require further study.

In general, the erection of small structures in a rural area was not regarded as a terrain disfigurement, and in many cases might become a tourist attraction.

Energy production by windmills was a non-pollutant procedure, and as such was preferred to some other means of energy production.

#### 3. Water pumping systems

It was suggested that water pumping windmills should be adaptable to the existing pumps and wells and should not interfere with the traditional power source, which should be maintained as an alternative. However, some improvement in the efficiency of the traditional pumps might be desirable. Greek sail rotor adaptations or Chinese vertical-axis variations might be most adaptable to traditional pumps, such as Persian wheels, rope and bucket lifts, and square-pallet wooden chain pumps.

In a situation where there was no existing pump, the ideal installation should have an integrated system comprising a well-matched rotor and pump. It was recommended that urgent consideration be given to the development of design specifications and prototype testing of wind pumping systems most appropriate for water lifting in conditions most typical of the region, particularly for units of 1 kW for irrigation and 0.1 kW for domestic water supply. It was recommended that a detailed classification of the performance and construction characteristics of rotors and slow-speed pumps be urgently compiled in order to facilitate and optimize the design of suitably matched wind-powered pumping systems.

The design procedure given in the consultant's paper was discussed and found to be a reasonable checklist of design criteria. The importance of careful preliminary investigations of local design determinants was stressed.

Performance specifications and design requirements were drawn up for wind-powered water pumping systems for immediate use in rural development:

Type 1: mechanical power output at shaft: 1kW, to suit existing pumps.

Rated wind speeds:

low	— 3.5 m/sec
medium	— 5 m/sec
high	— 7 m/sec

Rotor diameters: typically 5 to 20 m;

Power transfer: rotary power output near ground;

Starting torque: high torque required;

Normal operating shaft speed: low;

Fail safe gust protection: the windmill should have the ability to survive occasional extreme wind speeds;

Operational control: the windmill should have the ability to be occasionally manually adjusted from ground level.

Type 2: as above, but with matched high, medium and low head pumps.

Type 3: 0.1 kW as type 2.

Minimum cost would be most easily realized by using labour-intensive construction and local materials and skills; for instance, where almost constant attendance was feasible, construction cost may be reduced by simplification of control mechanisms.

#### 4. Electricity generating systems

Available designs were reviewed and found to be expensive and generally not practical for rural use. It was considered that a real need existed for low-cost plants suitable for the relatively low average wind speeds characteristic of much of the region. It was agreed that 5 m/sec should be taken as a reasonable rated wind speed applicable to the region.

Development of a series of three types of wind-electric generators with rated capacities of 0.250, 1-2 and 5-6 kW was suggested as a practical means of supplying power for remote areas. Critical uses included lighting, educational TV, radio, microwave repeaters, various agricultural uses, and food refrigeration.

At or above 1 kW it was agreed that three-phase/AC 380-440 volt generation appeared to be the most economical. It was considered that, for wind-electric generating systems, over-all efficiency was a more critical consideration than in water pumping systems.

Performance specifications and design requirements for wind-electric generating systems were drawn up for immediate development in the region:

*Type 1:* 250 W delivered to battery;

Voltage output: to suit lead-acid batteries 12-36 V;

Rated wind speed 5 m/sec;

Utilization: village lighting and TV, remote communications etc.;

DC generator or alternator-rectifier.

*Type 2:* 1-2 kW at load;

Voltage rating: 380-440 V AC three-phase;

Load: 12-36 V batteries, or loads such as electric pumps, resistive heating and small appliances.

*Type 3:* 5-6 kW at load;

Voltage rating: 380-440 V AC three-phase;

Load: 12-36 V batteries or loads such as electric pumps, resistive heating, and small appliances;

Rated wind speed 7 m/sec.

#### 5. Analysis of basic components

It was considered that regional development of wind energy was restricted because of a lack of appropriate design information for the guidance of technicians and decision-makers, and that priority should be given to the compilation and dissemination of suitable technical reference material, including aerodynamic design data, performance estimation and guidance on construction using available technology.

##### *Rotors*

It was agreed that optimum rigid aerofoil designs were best for practical wind-electric generation, but simple and less efficient rotors were satisfactory for water lifting by wind power. It was considered that wind-powered water pumping systems comprising high-speed rotors matched with appropriate pumps had considerable potential for future development. For immediate application in water pumping, the Greek configuration sail rotor was considered the most appropriate. Cambered metal plate rotors seemed well suited to applications where greater durability and increased efficiency were desired, provided the greater cost and weight could be tolerated. The Darrieus and Savonius rotors were not recommended for water pumping use, but the classic Chinese vertical-axis rotor might have some potential for low-cost water pumping in rural areas. A guide to application of the various types of rotors is given in figures 1-7. In general, down-wind rotors were considered desirable from the viewpoint of elimination of the tail cost and the elimination of the danger of the rotor hitting the tower in high winds.

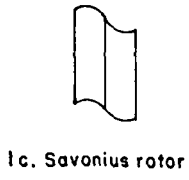
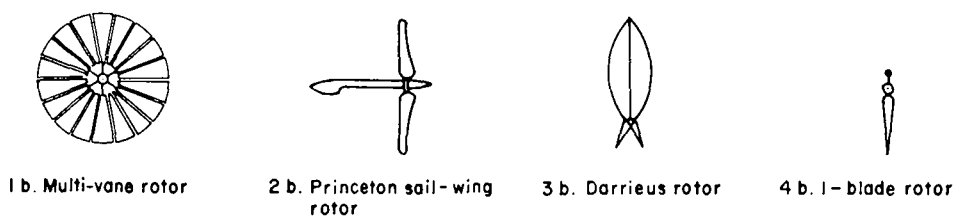
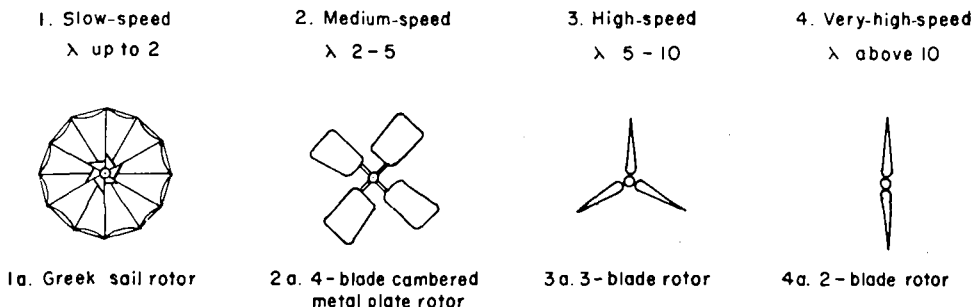

- |                                 |                                   |
|---------------------------------|-----------------------------------|
| A = Swept area                  | n = Rev/sec                       |
| C = Chord length                | u = Tip speed                     |
| $C_A$ = Axial force coefficient | v = Wind velocity                 |
| $C_D$ = Drag coefficient        | $v_{rel}$ = Relative air velocity |
| $C_L$ = Lift coefficient        | $\lambda$ = Tip speed ratio       |
| $C_M$ = Torque coefficient      | $\rho$ = Air density              |
| $C_p$ = Power coefficient       | $\sigma$ = Solidity factor        |
| $F_A$ = Axial force             | Units - m, kg, sec, kW            |
| M = Torque                      |                                   |
| P = Power                       |                                   |
| R = Radius of rotor             |                                   |
| Re = Reynolds number            |                                   |
| $\nu_k$ = Kinematic viscosity   |                                   |

Tip speed ratio	$\lambda = \frac{u}{v} = \frac{2\pi n R}{v}$	$Re = \frac{v_{rel} C}{\nu_k}$
Power coefficient	$C_p = \frac{2P}{\rho v^3 A}$	$\rho = 0.5 \text{ kg/m}^3$
Torque coefficient	$C_M = \frac{2M}{\rho v^2 R} = \frac{C_p}{\lambda}$	$\nu_k = 15 \times 10^{-6} \text{ m}^2/\text{sec}$
Axial force coefficient	$C_A = \frac{2F_A}{\rho v^2 A}$	$6A = \text{Frontal blade area measured along chord}$
		$M = \frac{P}{2\pi n}$

Figure 1. Basic rotor characteristics

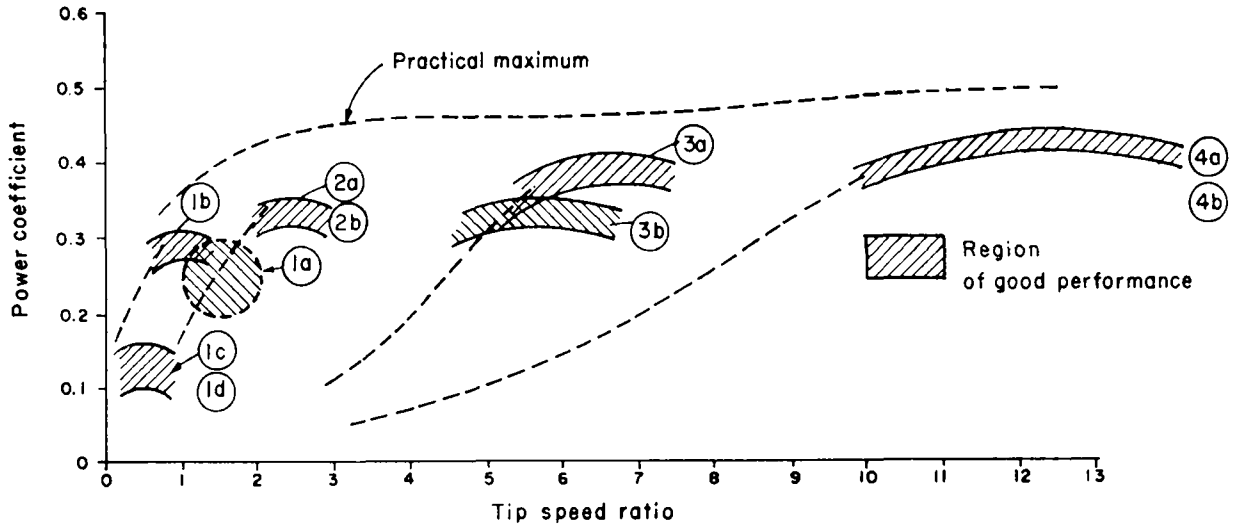

Figure 2. Power coefficient

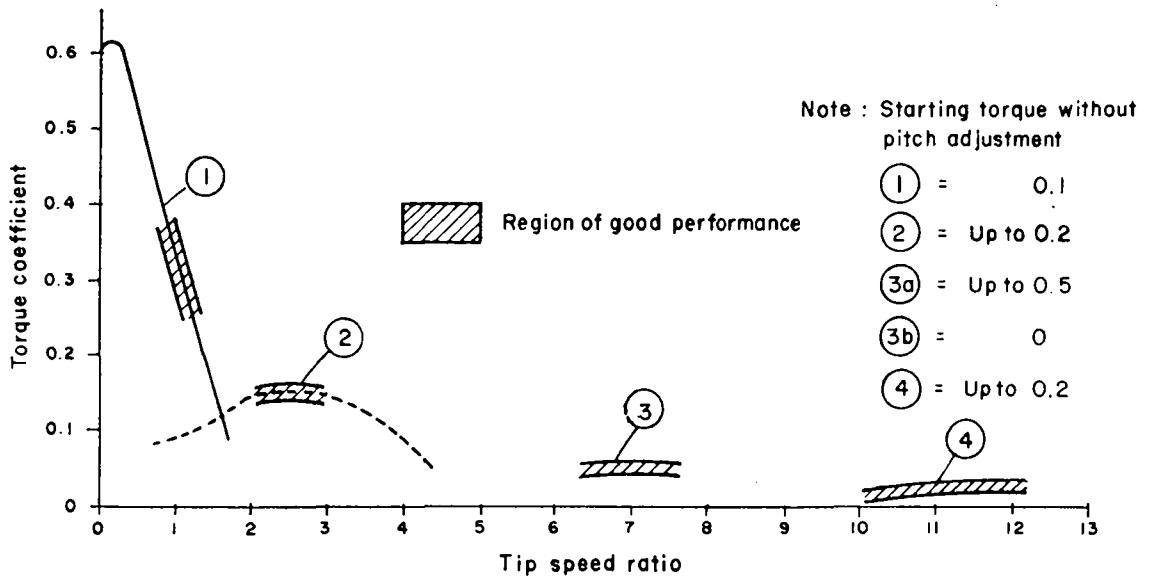

Figure 3. Torque coefficient

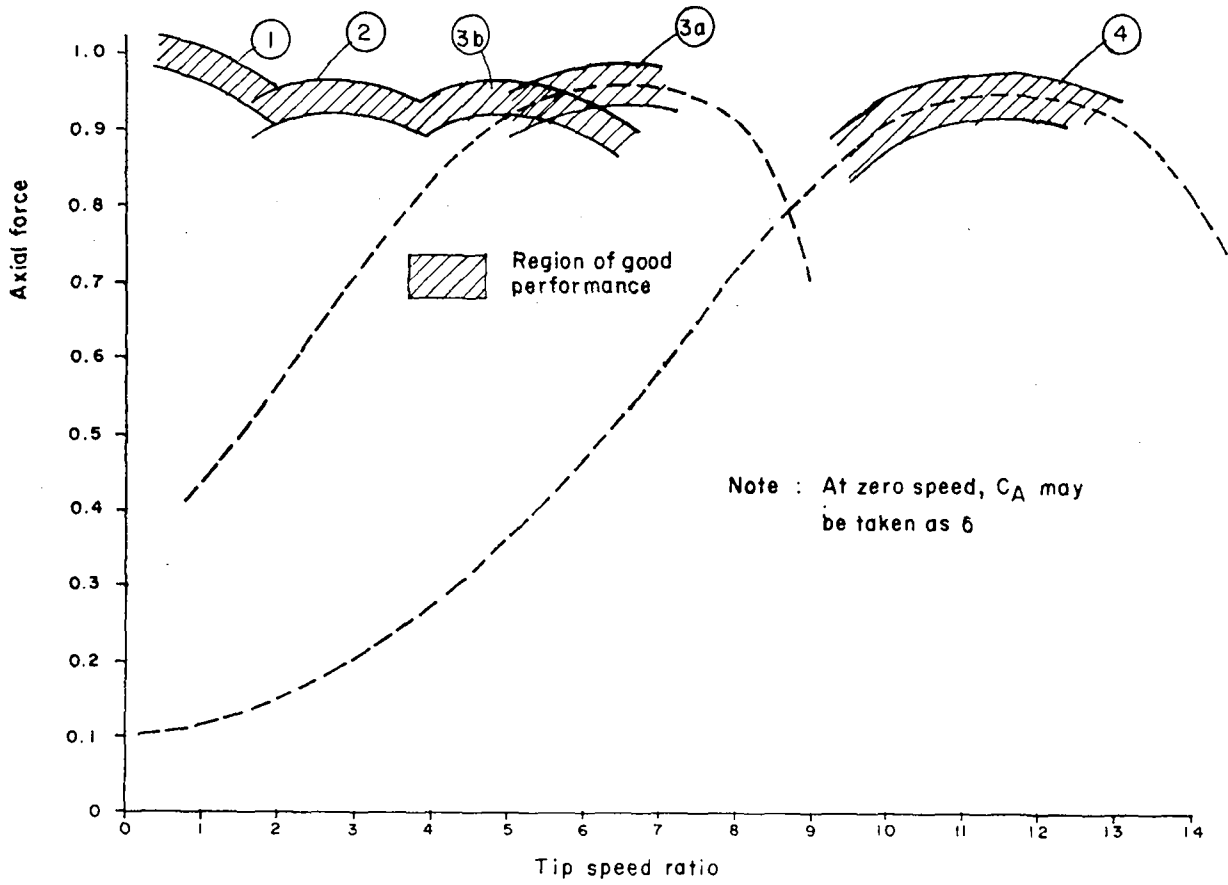

Figure 4. Axial force on spinning rotor

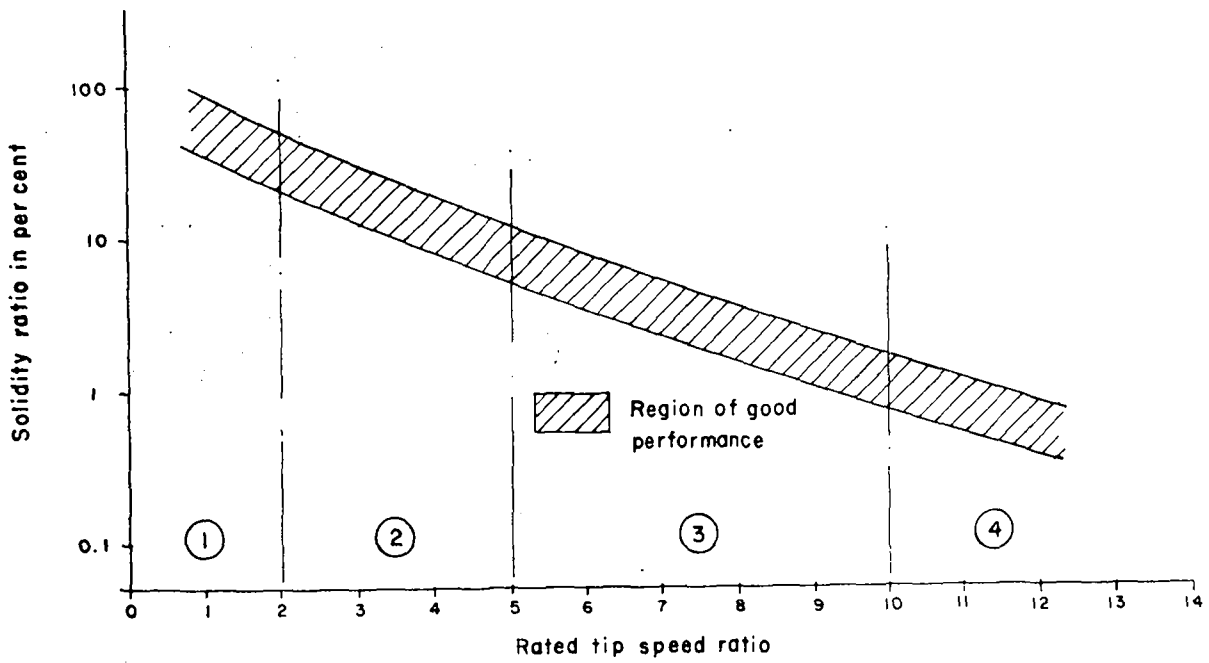

Figure 5. Solidity ratio for optimum performance



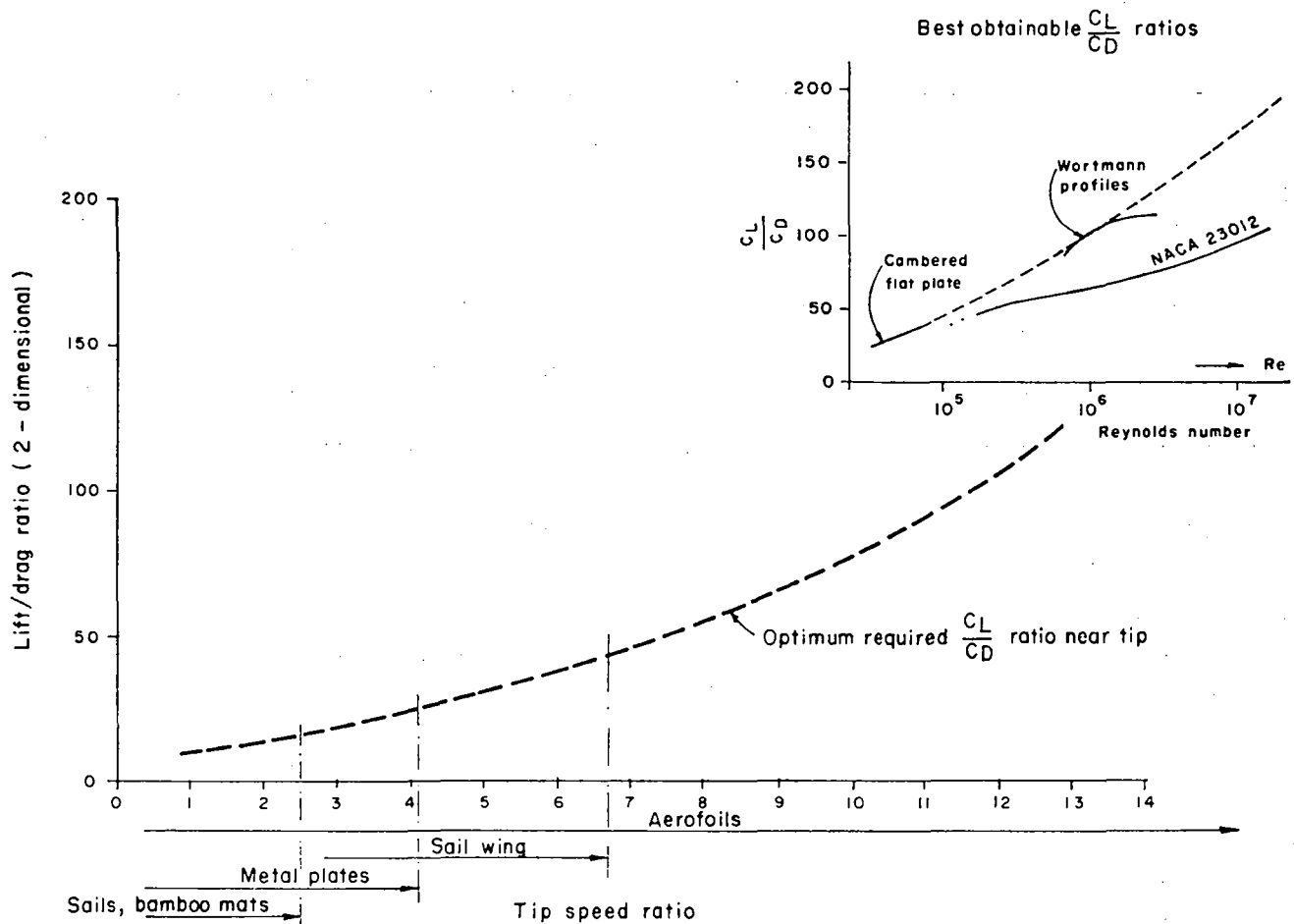

Figure 6. Lift/drag ratio

**Hub and shaft**

Use of hand-crafted wooden hubs seemed to be quite suitable for slow-speed rotors. Wooden main shafts had been widely used in some countries and might find wider applications in new hybrid slow-speed designs. Solid steel or pipe main shafts would provide equal performance and longer life than wooden shafts. "Teetering hubs" were useful for relieving bending loads on high-speed rotor shafts as a result of unequal disc loading.

**Bearings**

Oil-soaked wooden bearings had been used successfully in the past and were preferable to steel ball and metal bearings for many slow-speed applications.

**Orientation mechanism**

The options for orienting the rotor into the wind included tail vane, down-wind rotor, manual orientation by tail rope or A-frame support, fan-tail rotor and electric servo-mechanisms. In situations where the wind direction was fairly constant, such as along

coastlines and many equatorial regions, significant construction savings might result from fixed alignment of the rotor. Where change of wind direction was infrequent, manual orientation might be most economical. Servo-orientation was best adapted to large wind-electric generators. In construction of the tower-head bearing, the use of simple greased plates was adequate. Use of a hollow post for the tower-head bearing might result in decreased cost and simplified construction.

**Towers**

Tower height range was usually 5 m to 20 m, depending on the shape of the rotor, the need for appropriate ground clearance and the proximity of nearby wind obstructions. Selection of tower design depended primarily on the local materials available, which might be:

*Angle iron*, using traditional bolted or welded lattice structure.

*Tubular steel*, using a triangular base and geodetic (octahedron module) structure, with bolted joints.

<i>Type</i>	<i>Fabrication technology</i>	<i>Initial cost</i>	<i>Maintenance</i>	<i>Control</i>	<i>Life</i>	<i>Typical application</i>	<i>Rated wind-speed</i>	<i>Diameter</i>
1. Slow-speed rotors								
1a. Greek sail rotor .	Local	Low	Regular local	Manual	Medium	Water pumping	Low, medium	Up to 10 m
1b. Multi-vane rotor .	Medium (as now made)	Medium	Trained personnel	Automatic	Long	Water pumping	Low, medium	Up to 8 m
	Could be local	Low	Local	Semi-automatic	Medium	Water pumping	Low, medium	Up to 6 m
1c. Savonius rotor .	Local	Low	Local	Nil	Medium	Water pumping	Medium, high	Up to 3 m
1d. Chinese vertical-axis rotor . .	Local	Low	Regular local	Manual	Medium	Water pumping	Low, medium	Up to 10 m
2. Medium-speed rotors								
2a. 4-blade cambered metal plate rotor	Medium technology or local	Medium	Low, trained personnel	Automatic or semi-automatic	Long	Water pumping	Medium	Up to 6 m
					Medium			
2b. Princeton sailing rotor . . . . .	Local, medium or high	Low, medium	Regular, trained personnel	Automatic	Medium	Water pumping, electricity	Medium, high	Up to 8 m
3. High-speed rotors								
3a. 3-blade rotor . .	Local wood or metal	Low	Regular local	Automatic	Medium	Electricity, water pumping	Medium, high	Up to 5 m
	Fibreglass reinforced plastic	Medium	Low, trained personnel	Automatic	Long	Electricity	Medium, high	Up to 10 m
3b. Darrieus rotor .	Extruded aluminum or fibreglass reinforced plastic	Medium	Low, trained personnel	Automatic	Long	Electricity	High	Up to 24 m
4. Very-high-speed rotors								
4a. 2-blade rotor . .	Metal or fibreglass reinforced plastic	High	Low, trained personnel	Automatic	Long	Electricity	High	Greater than 10 m
4b. 1-blade rotor . .	Metal or fibreglass reinforced plastic	High	Low, personnel trained	Automatic	Long	Electricity	High	Greater than 10 m

Figure 7. Practical aspects of some rotors

*Multiple wood-pole structure with cross-bracing of wood or tensioned cable, with base bolted to foundation.*

*Concrete pipes stacked end to end, with central tensioning between end plates against the top and bottom of the column of concrete pipes. Concrete fill might be used. The upper end plate was incorporated for mounting of the windmill. The entire column might be stabilized by guy wires attached to a ring at maximum height to allow rotor clearance.*

*Single wood-poles, which might be self-supporting or hinged at the ground and guyed.*

Approved local building practices should be followed in regard to foundation construction. Ease of erection and lowering, for maintenance of the rotor, was essential. The single column, with three stays, was convenient, particularly for electricity generation. In the case of a water pumping windmill, the pump shaft (whether reciprocating or rotary) could be led down one side of the column, with the vertical axis of the windmill offset to the side accordingly.

*Control mechanisms*

Allowance should be made for either manual or automatic control of starting, stopping, overspeeding (governing) furling or reefing of sails, and protection

against unexpected high wind speeds (fail safe device). Maximum use of manual control devices would lead to savings in construction cost. Automatic controls were necessary for unattended operation. The dynamics of variable-pitch control of rigid aerodynamic rotors was not well understood and required more detailed technical study. Adjustment of piston stroke in water pumps could be provided by a horizontal lever arm.

*Power transfer mechanisms*

It was agreed that the use of rotary power transfer was most desirable for optimal matching of rotor-torque characteristics with many types of pumps. That transfer might be accomplished by long vee-belts, chains, shaft and gears, chains and cowhide belts. Electric transmission should be considered only for loads greater than 1 kW.

*Power utilization*

Any load must be able to accept a variable shaft speed and power input. There was an immediate need for a comprehensive design selection manual on water pumps in the range of 0.1-10.0 kW for high, medium and low pumping heads. Special attention should be paid to ascertaining the performance and construction characteristics of lesser-known pumps that were currently confined to limited areas of use. Some information is given in table 1.

Table 1. PUMP CHARACTERISTICS

Pump type	Range of head		Efficiency (percentage)	Starting torque	Speed (rev/min)	Typical material
	Suction (m)	Discharge (m)				
Piston . . . . .	7	100	80	high	30	metal
Turbine . . . . .	5	100	90 max.	low	1,400-2,000	metal
Ladder . . . . .	0	3	35	medium	80	wood
Wood chain . . . . .	0	4	50	medium	80	wood
Steel chain . . . . .	0	30	50	medium	80	metal
Screw . . . . .	0	5	60	low	30-400	wood
T-pump . . . . .	7	0	60	low	400	metal
Inertia . . . . .	0	4		low	80	metal
Piston . . . . .	10	30	80	high	30	metal
Diaphragm . . . . .	7	30		high	30	metal, leather
Rope and bucket . . . . .	0	50	90	high	2	cloth, leather, metal
Double-acting piston . . . . .	7	100	85	high	30	metal, plastic
Peristaltic . . . . .	1.5	10	70	low	100	5-12 cm plastic, rubber
Paddlewheel . . . . .	0	0.5	20	low	80	wood
Persian wheel . . . . .	0	50	50	medium	4	metal
Spiral wheel . . . . .	0	1	60	low	60	wood
Propeller . . . . .	0	7	60	low	400-2,000	metal

### *Electric generators*

It was suggested that in order to formulate proper rotor matching guidelines, torque-speed characteristics of alternators and generators should be compiled. It was agreed that brushless low-speed 380-440 V AC three-phase alternators were most appropriate for use in wind-electric generation. Generators from trucks, railway carriages and automobiles might be adapted to wind-electric generation.

### *Storage*

Wind energy utilization was most economical where storage was not required. Storage requirements might be minimized by adopting changes in usage patterns. Secondary use of water-storage tanks for bathing, washing and fish culture might be considered. Pumped water storage for energy conversion by a small water turbine and generator might be practical in some limited situations. Compressed air production and storage might be feasible in some cases.

### *Hybrid designs*

Development of new hybrid windmill designs was considered. Some suggested possibilities were the use of classical Greek and Chinese slow-speed rotors for electricity generation, Thai high-speed wooden rotors for electric generation, high-speed rotors for water pumping and Thai sail rotors with A-frame manual orientation.

## **6. Other uses and advanced concepts**

It was considered that there was potential for further development of wind-generated energy supply for grain grinding, cane crushing, oilseed pressing, air circulation in crop driers, refrigerator operation, wood sawing, water aeration for sewage oxidation and aeration of intensive aquaculture ponds. Maximum windmill economy might be achieved by multipurpose use.

Several advanced concepts suggested for development in the region were: large-scale wind-electric generators for supply to an electric distribution grid; regional manufacture and use of high-efficiency solid state inverters for use with variable DC wind-electric generators; regional manufacture and use of variable speed input, constant frequency output alternators; development of special rotors, such as the single-blade high-speed type; and development of regional batch and mass production of aerodynamic rotor blades using available materials.

Continuing research and development outside the region should be monitored by ESCAP and information on relevant developments disseminated to appropriate organizations in the region for regional adaptation.

## **7. Field trips**

During the field trips, preliminary performance measurements were made on a Thai bombo-mat sail rotor in Samut Songkram and a Thai high-speed wooden rotor in Samut Prakarn. Each machine was coupled to a wooden-pallet chain pump for lifting salt water to salt-production ponds. Time did not allow a complete analysis of those observations.

The Group felt that reliable measurement of the performance characteristics of local windmill systems should be encouraged throughout the region.

## **8. Conclusions and recommendations**

It was concluded that the current level of expertise and technology available in the region was sufficient for immediate implementation of selected wind-energy utilization devices. However, additional activities must be initiated to further expand its use.

The following recommendations were made:

1. A systematic survey of existing wind velocity data in the region should be made with a view to its use for standard wind energy analysis.
2. A variety of simple cheap anemometers should be developed and produced within the region.
3. Standard methodology should be developed for the analysis and extrapolation of incomplete wind speed data.
4. A detailed classification of the performance and construction characteristics of all wind rotors should be compiled in order to facilitate and optimize the design of properly matched wind-powered systems.
5. A detailed survey of component characteristics should be undertaken on an international scale in order to provide an illustrated "catalogue" of proven components which could be used in the design of new hybrid wind-powered systems.
6. A detailed classification of the performance and construction of all water pumping devices between 0.1 and 10 kW should be compiled in order to facilitate and optimize the design of properly matched wind-power pumping systems.
7. A guide-book on windmill design processes should be compiled and made available to development workers.
8. Efforts should be made to encourage research, development and training in universities, technical colleges and research institutes, including fellowships, development of courses and text material.

9. Efforts should be made to stimulate immediate utilization of proven wind-energy technology via existing industry and non-governmental organizations, rural development and extension services.

10. Efforts should be made to stimulate commercial and industrial involvement in production and promotion of wind-energy utilization devices.

11. Expert engineering advice should be made available for optimization of water pumping and electric generating windmills currently available in the region.

12. Socio-economic considerations should be further studied where local labour and renewable materials may be freely available.

13. Continuing research and development outside the region should be monitored by ESCAP and information on relevant developments disseminated to

appropriate organizations in the region for regional adaptation. This may take the form of a regional wind-energy documentation centre.

14. ESCAP should follow up this meeting by further expert technical meetings to report and evaluate current progress in the field.

15. An effort should be made to ensure that the wind energy section in the proposed regional technology transfer centre be adequate for the needs of the region.

16. ESCAP should encourage and co-ordinate the setting up of field demonstrations of wind-energy utilization devices in the region.

Highest priority should be given to recommendation number 16, which implies that work related to some of the other recommendations would have been initiated.

### Annex III

## REPORT OF THE SOLAR/WIND ENERGY SECTORAL GROUP

Discussion revealed that, while attention had been given to the integration of both solar and wind energy into other energy systems, there was little experience in the integration of those two energy forms.

The Group considered that, given the variability in availability of both solar and wind energy in any location, the potential for use of bio-gas in many rural situations, and the possible use of each of those energy forms to complement each other, and in conjunction with other forms of energy, there was a need to explore ways in which the use of various types of integrated energy systems might be stimulated.

Accordingly, the Group recommended:

1. That studies be made of:

(a) Meteorological data;

(b) Availability of the appropriate materials and skills for construction, operation and maintenance;

(c) Present and potential demands for energy in its various forms; and

(d) The ways in which these demands might appropriately be met, having regard to likely

availability of both conventional and non-conventional energy resources, singly or in combination; in representative rural communities in various countries of the region, to assist in planning the development of energy resources in rural communities.

2. That research and development be carried out on integrated energy systems for small rural communities with a view to:

(a) Establishing technological and environmental feasibility in favourable circumstances;

(b) Making the best use of materials and skills available in various local environments; and

(c) Optimization of systems performance with due regard to energy balance and cost-effectiveness.

3. That demonstrations of selected integrated energy systems be carried out in selected localities for the purposes of providing information for potential users, ensuring the necessary system reliability under normal operating conditions, and obtaining socio-economic data needed for commercial development.

## Annex IV

## LIST OF EXPERTS

- R. V. Dunkle, Chief Research Scientist, Division of Mechanical Engineering, CSIRO, Highett, Victoria 3190, Australia
- N. R. Sheridan, Reader in Mechanical Engineering, University of Queensland, Brisbane, Australia
- P. Johnston, Energy Unit, Central Planning Office, Government Buildings, Suva, Fiji
- C. L. Gupta, Professor, Applied Science Group, Sri Aurobindo International Centre of Education, Pondicherry 605002, India
- S. K. Tewari, Scientist, National Aeronautical Laboratory, Bangalore 560017, India
- Filino Harahap, Director, Development Technology Centre, Institut Teknologi Bandung (ITB), Bandung, Indonesia
- Harijono Djojodihardjo, Lecturer, Mechanical Engineering Department, Institut Teknologi Bandung (ITB), Bandung, and Head, Aerospace Technology Centre, the National Institute of Aeronautics and Space (LAPAN), Djakarta, Indonesia
- T. Noguchi, Chief, Solar Research Laboratory, Government Industrial Research Institute, Hirate-machi, Kita-ku, Nagoya, Japan
- P. T. Smulders, Steering Committee Wind Energy Developing Countries, c/o Physics Department, Wind Energy Group, University of Technology, Post Box 513, Eindhoven, Netherlands
- R. E. Chilcott, Department of Agricultural Engineering, Lincoln College, Canterbury, New Zealand
- Mian Masoul Anwar, Principal Scientific Officer, Pakistan Atomic Energy Commission, Islamabad, Pakistan
- Ernesto N. Terrado, Supervising Nuclear Technologist, Philippine Atomic Energy Commission, Diliman, Quezon City, Philippines
- Jong Hee Cha, Head, Thermal-Hydraulics Laboratory, Korea Atomic Energy Research Institute, Seoul, Republic of Korea
- Chung-Oh Lee, Professor, Department of Mechanical Engineering, Korea Advanced Institute of Science, Seoul, Republic of Korea
- Prapath Premmani, Director, Technical Division, National Energy Administration, Bangkok, Thailand
- Sompongse Chantavorapap, Chief, Design and Energy Research Section, National Energy Administration, Bangkok, Thailand
- Chalermchai Suksri, Chief, Power Resource Research Unit, Agricultural Engineering Division, Department of Agriculture, Kasetsart University Grounds, Bangkok, Bangkok-9, Thailand
- Suthin Nopparat, Agricultural Engineering Division, Department of Agriculture, Kasetsart University Grounds, Bangkok, Bangkok-9, Thailand
- P. A. Cowell, Chairman, Division of Community and Regional Development, Asian Institute of Technology, P. O. Box 2754, Bangkok, Thailand
- R. H. B. Exell, Division of Community and Regional Development, Asian Institute of Technology, P. O. Box 2754, Bangkok, Thailand
- Ray Wijewardene, Farming Systems Engineering, International Institute of Tropical Agriculture, Oyo Road, P.M.B. 5320, Ibadan, Nigeria
- R. L. Datta, Central Salt and Marine Chemical Research Institute, Bhavnagar, Gujarat, India (consultant)
- M. M. Sherman, New Alchemy Institute-East, Box 432, Woods Hole, Massachusetts, 02543, United States of America (consultant)

**Annex V**  
**LIST OF DOCUMENTS**

<i>Symbol number</i>	<i>Title</i>	<i>Source</i>
NR/ERD/EWGSW/1	Provisional agenda	Secretariat
NR/ERD/EWGSW/2	Annotated provisional agenda	Secretariat
NR/ERD/EWGSW/3	Development of wind energy utilization in Asia and the Pacific	Secretariat
NR/ERD/EWGSW/4	An introduction to integrated solar-wind systems	Secretariat
NR/ERD/EWGSW/5	Solar energy; its relevance to developing countries	Secretariat
NR/ERD/EWGSW/6	The design and construction of low-cost wind-powered water pumping systems	Secretariat
NR/ERD/EWGSW/CR.1	Solar energy research in the Philippines	E. N. Terrado (Philippines)
NR/ERD/EWGSW/CR.2	Solar energy in India: research, development and utilization	C. L. Gupta (India)
NR/ERD/EWGSW/CR.3	A review of efforts made in India for wind power utilization	S. K. Tewari (India)
NR/ERD/EWGSW/CR.4	Recent developments in solar energy research and application in Japan	T. Noguchi (Japan)
NR/ERD/EWGSW/CR.5	Research, development and use of wind energy in Thailand	National Energy Administration, Thailand
NR/ERD/EWGSW/CR.6	Recent research and development on solar energy applications in Japan	T. Noguchi (Japan)
NR/ERD/EWGSW/CR.7	Solar energy in Australia	R. V. Dunkle (Australia)
NR/ERD/EWGSW/CR.8	Solar energy in southeast Asia	R. H. B. Exell, Asian Institute of Technology
NR/ERD/EWGSW/CR.9	Solar energy and energy conservation in Australian buildings	N. R. Sheridan (Australia)
NR/ERD/EWGSW/CR.10	Research, development and use of solar energy in Thailand	National Energy Administration, Thailand
NR/ERD/EWGSW/CR.11	Programme and progress for solar house development in Korea	Jong Hee Cha (Republic of Korea)
NR/ERD/EWGSW/CR.12	Solar energy as a natural resource	N. R. Sheridan (Australia)
NR/ERD/EWGSW/CR.13	The utilization of wind energy in Australia	Department of Science, Australia
NR/ERD/EWGSW/CR.14	The prospects of solar energy utilization: the Indonesian case	F. Harahap (Indonesia)

---

<i>Symbol number</i>	<i>Title</i>	<i>Source</i>
NR/ERD/EWGSW/CR.15	A review of renewable energy in New Zealand with emphasis on wind power utilization	R. E. Chilcott (New Zealand)
NR/ERD/EWGSW/CR.16	Windpower studies in Korea	Chung-Oh Lee (Republic of Korea)
NR/ERD/EWGSW/CR.17	Research and prospects of wind energy utilization in Indonesia	H. Djojodihardjo (Indonesia)
NR/ERD/EWGSW/CR.18	The Sunshine Project: solar energy research and development	Agency of Industrial Science and Technology, Japan
NR/ERD/EWGSW/CR.19	Solar energy work in Pakistan	M. M. Anwar (Pakistan)
NR/ERD/EWGSW/CR.20*	Planning for small-scale use of renewable energy sources in Fiji	P. Johnston (Fiji)

---

\* Delayed in transit and not distributed.



**Part Two**

**DOCUMENTATION ON SOLAR ENERGY**

## I. WORKING PAPER PRESENTED BY THE SECRETARIAT

### SOLAR ENERGY: ITS RELEVANCE TO DEVELOPING COUNTRIES (NR/ERD/EWGSW/5)\*

#### INTRODUCTION

Over 1,000 million people live in underdeveloped economic conditions around the world between latitudes 35°N and 35°S; that area also receives the highest concentration of solar radiation. Most of the developing countries in the ESCAP region lie between those latitudes; the relatively high population densities in rural areas, and high exposure to the sun, suggest that the use of solar energy should be explored when considering energy problems in the region.

In planning applications for solar energy, a distinction must first be drawn between the energy requirements in rural and in urban areas. The rural population needs energy primarily for cooking, lighting, irrigation and household water supply, water purification, processing of agricultural products and recreation. Solar power devices to serve those purposes might include cookers, pumps, driers, and solar stills.

In small-to-medium urban areas, the most important uses for energy are in agriculture, household maintenance, industry, and transportation, among others. Those needs might someday be met with mini-generators powered under the "energy plantation" concept or by photothermal devices (use of selective surfaces), but, in the meantime, available solar energy devices include those for water and space heating, cooking, refrigeration and distillation.

Energy consumption in metropolitan areas follows an entirely different pattern, with industrial and manufacturing plants taking a major share of available power; the commercial, transport and domestic sectors consume varying but smaller percentages. Solar devices appear to have a relatively less significant role in metropolitan areas, being used mainly for heating of water and space, and cooling. In time, direct conversion processes for large-scale power generation, either photovoltaic or photothermal, may be developed. Promising fields for further research and development also include solar ponds for small-scale power production, high-temperature furnaces, thermoelectric and thermo-ionic conversion processes, algal ponds, and such integrated systems as solar houses.

\* Prepared by Mr. R. L. Datta, consultant on solar energy, at the request of the ESCAP secretariat. The views expressed in this paper are the author's own and do not necessarily reflect those of the secretariat or the United Nations.

#### *Solar energy characteristics*

In general, the greatest amount of solar energy is found in two broad bands around the earth between latitudes 15° and 35° north and south (references S 1, S 2). In the best regions, there is a minimum monthly mean radiation of 500 calories per square centimetre per day (cal/cm<sup>2</sup>/day). These regions are on the equatorial side of the world's arid deserts. They have less than 25 cm of rain in a year. In some countries, more than two thirds of the area is arid, and there is usually over 3,000 hours of sunshine per year, over 90 per cent of which comes as direct radiation. These areas are well suited for applied solar energy.

The next most favourable region for the purpose is in the equatorial belt between latitudes 15°N and 15°S. There the humidity is high, cloud cover is frequent, and the proportion of scattered radiation is high. There are about 2,500 hours of sunshine per year, with very little seasonal variation. Radiation is from 300 to 500 cal/cm<sup>2</sup>/day throughout the year. Between latitudes 35° and 45°, at the edge of the desert areas, the radiation can average 400 to 500 cal/cm<sup>2</sup>/day on a horizontal surface throughout the year, but there is a marked seasonal effect, and the winter months have low solar radiation. The seasonal variation can be greatly minimized by tilting the receiving surfaces to face the sun. The regions beyond latitudes 45°N and 45°S are limited in their year-round direct use of solar energy.

Several types of instruments are known for measuring and recording solar characteristics. Some instruments give instantaneous readings and others give integrated readings over periods of an hour or a day. Some measure the total radiation and others measure only direct radiation on horizontal, vertical, normal or inclined surfaces. The principles used in the operation of different types of instruments include thermoelectric measurement of the rise of temperature on a black solar receiver; balancing the heat with measured electrical Peltier cooling; direct calorimetric measurements; evaporation of a measured volume of liquid; photovoltaic measurements, photographic measurements; and photochemical actinometers. Examples are the Eppley pyrheliometer, the Moll-Goczynski solarimeter, the integrating solarimeter developed in Australia, and the Campbell-Stokes sunshine recorder.

There is ample scope for development of very much simpler and portable types of solarimeters

sufficiently accurate (within  $\pm 5$  per cent or so) for planning the development of solar energy. Evaluation of solar radiation is a prerequisite for sound plans for solar energy use.

A number of solar radiation stations exist in a few countries of the ESCAP region. In India, there are more than 26 stations, operated by the Indian Meteorological Department, and there are some 60 stations measuring duration of sunshine with Campbell-Stokes recorders. Indonesia currently has 15 radiation stations, most of which are operated by the Meteorological and Geophysical Institute, and others by educational and research institutions. Each of the ESCAP countries involved in solar energy applications might well have a chain of solar radiation stations selected on the basis of geographical/meteorological/climatic peculiarities; these stations could be the control points for solar radiation data collected by portable solarimeters. ESCAP should therefore co-operate with the World Meteorological Organization (WMO) in assisting countries to set up radiation stations, and to prepare solar maps for each country.

## I. TECHNOLOGY OF SOLAR DEVICES

There are three broad approaches to the utilization of solar devices and processes: (a) low-grade solar heat, (b) direct conversion to electric energy, and (c) photosynthetic and biological conversion processes. Of these, the technology of low-grade heat devices has been developed to such an extent that they have immediate applications, particularly in rural and small urban areas. However, a realistic assessment on a continuous basis is required regarding the impact of these devices on social and economic conditions; moreover, the need for research and development to improve these devices should be kept under review.

Although the technology has been developed for direct conversion and biological processes, extensive research and development is required to put these on a satisfactory basis for general use.

### A. PRODUCTION OF LOW-GRADE HEAT

Devices for conversion of solar energy for the production of low-grade heat include water-heaters, solar stills, cookers, driers, refrigerators and pumps. Most of these devices use a collector or concentrator of solar energy, utilizing the energy produced to heat a working fluid with varying degrees of efficiency. The status of these devices should be reassessed with reference to rural areas in the region; technological, economic and social constraints; potential uses; and feedback of problems.

### 1. Solar water-heaters

Basically, a solar water-heater comprises a black, metal flat-plate collector (absorber) containing water channels, facing the general direction of the sun, together with an insulated storage. There can be one or more transparent covers for the collector at intervals of about 2 cm above the plate, and thermal insulation at the rear. The higher the number of covers, the higher is the temperature reached in the collector, but the less is the energy that reaches the plate. Materials for collectors differ around the world: copper is mainly used in Australia, and galvanized iron in India and Israel. The heating selective surface of the collector should have durable coating with a high ratio of absorptivity to emissivity; for example, Australian selective surface coatings have a ratio of 6. The three basic types of solar heaters are described below.

(a) *Domestic water-heaters* consist of a flat-plate collector and a separate water storage tank connected to the public water supply either directly in pressurized units, e.g. as found in Israel and Australia, or through a float valve such as developed in India. The water circulates by convection. Normally, the absorber is a sheet of copper or galvanized iron to which is soldered or brazed a continuous zigzag tube, the main direction of the tubing being slightly off the horizontal to prevent air-locks at the bends. Water flows either by gravity or from a pump into the lower end of the tube, and back and forth across the surface of the sheet, issuing at the upper opening. The spacing between the bends of this tubing may vary, and in some designs may be 15 cm. In some versions, the collector is in the form of a sandwich which consists of corrugated galvanized iron sheet backed with a plain sheet of the same material, the two being secured by rivets: the edges along the length are hammered together with an overlap, and sealed with soft solder. The openings along the width at the two ends are formed into pipes by folding the plane sheet over the corrugated sheet, then welding or soldering. In this manner, header pipes are formed at the two ends. The corrugated face is blackened and the whole assembly can be put in a wooden box containing insulating material. The upper face of the box is glazed with a sheet of window glass, with an air gap of perhaps 5 cm. Water from an insulated cylindrical reservoir is allowed to enter the collector from its lower header, and flows up through the channels formed by the corrugations out to the upper header, and then on to the upper end of the reservoir. In this manner, closed-cycle thermosyphon circulation is established and the water temperature rises in the reservoir. This corrugated type of flat-plate collector has good heat-exchange efficiency, of about 50 per cent, and heats water to 50°C to 60°C. Alternatively, the collector may consist of galvanized tubes fitted at 10 cm centre-to-centre spacing on two

pipe headers; aluminium sheet is wrapped around the pipe network; each tube is kept in good thermal contact with this sheet; the collector is encased in an airtight, mild steel box having insulation on the rear side and ordinary window glass on the front side. The water level in the storage tank is maintained by a float valve, the storage tank being insulated by thick mineral wool which is protected from the weather by a cover box of mild steel sheet. Figure 1<sup>1</sup> shows a domestic heater with natural water circulation.

(b) *Built-in storage-type heaters*, with an integrated storage and absorber facility, consist of a galvanized iron, rectangular tank placed in a rectangular, mild steel sheet tray with ordinary window glass on the front and an insulating layer (5 cm) of glass wool on the back and sides. Tank bulging under pressure is reduced by using steel sections bolted to the sides of the tray. The front face of the tray is blackened. The hot water is removed at the top by opening the gate valve from the inlet pipe at the bottom. A vent pipe is also provided at the outlet pipe of the heater for safety purposes. A large funnel (bucket-size) can be fixed at the top of the heater and connected to the inlet tube so that this type of water-heater can be used in rural areas where there is no regular water supply. The efficiency of this type of heater may rise to 80 per cent conversion of solar energy to heat. In this heater, hot water is not normally available in the early morning.

(c) *Large-size water-heaters* for hotels, hospitals and other public uses, involve a number of absorber tanks and can heat water in quantities larger than 600 litres at temperatures up to 55°C in winter. This type also has an auxiliary heating system. The mean water temperature in the storage tank is controlled by a differential circuit. Efficiency of such heaters can be 55 per cent or higher. Australian scientists have developed multistage, high-temperature solar water-heaters which can possibly supply water commercially at as high a temperature as 95°C. This multistage type of solar heater uses different types of absorbers with different selective coatings as high-, medium- and low-temperature absorbers.

In a number of countries, including Australia, Israel, Japan and the United States of America, solar water-heaters are manufactured commercially. Certain factors must first be considered for critical evaluation of the different types of water-heaters: (i) a per-unit capacity which may be 0.01 m<sup>2</sup>/litre; (ii) provision of supplementary electrical heating, controlled by thermostat; (iii) the life of the heater; (iv) water supply: except in the case of the built-in storage design; (v) ease of operation; (vi) application in multistorey buildings; (vii) cost per unit of thermal energy; (viii) adaptability for customers' specifications; and (ix) product design, including finish.

<sup>1</sup> Figures at end of paper.

One of the inhibiting factors in the utilization of solar water-heaters is high capital costs. Reference S 3 indicates a number of factors upon which feasibility of solar water-heaters depends, e.g. cost, availability and cost of alternate sources of heating, efficiency of collection, and local cost of materials, and suggests that solar water-heaters generally prove competitive with fuel plants for small and medium-sized installations, e.g. for hotels and schools. Certain types of heaters, e.g. built-in storage type, may be more economic even with a relatively short life. Uses for solar heating exist in such industries as foods and pharmaceuticals, where the range of temperature required may reach 90°C or more; the development work on high-temperature water-heaters is significant in this context.

Technical/economic studies should be undertaken to improve the efficiency of solar water-heaters by (i) use of reflectors, (ii) selective coatings, (iii) modified collector design, and (iv) architectural integration. There is also scope for research and development on heaters for different temperatures and capacities, and on improving the durability of sealants, paints and other materials used in manufacture.

## 2. Solar distillation

Solar distillation can produce fresh water in isolated areas where natural water is too saline for ordinary use, for instance, salt farms, lighthouses and remote rural areas. Pure water is needed for lead-acid accumulators, engineering and chemical laboratories and pharmaceutical preparations. Solar stills have been known for a long time; design features are now well established, and desirable materials for construction are available. Figure 2 indicates the variety of uses of water so derived.

Currently, not more than about 30 per cent of the total solar energy can be used in distillation. The disadvantages of current models, with respect to the extent of useable solar energy and the high space requirement, are substantially reduced through the use of the humidification/dehumidification (HD) technique.

(a) *In solar stills for distillation of sea or saline water*, the water to be distilled is kept in black-bottom stills covered with airtight glass or plastic enclosures. Incident solar rays pass through the glass cover and are absorbed on the black bottom and heat the water. Vapour is formed and moves upward towards the covers which are relatively cool, condensing on the underside of the glass sheet. This condensed water slides on the sloping glass sheets and is collected in the channels provided at the lower edge of the cover. This technique depends on steady availability of high-intensity solar energy.

The first plant of large capacity based on this principle was built at Las Salinas, Chile, in 1874, with a surface area of 4,757 m<sup>2</sup> and a daily production of 22.5 m<sup>3</sup> per day of fresh water, and operated for some 40 years. Research contributions, mainly from the United States of America, the USSR, Algeria, Australia, Greece and India in recent years, are responsible for popularization of this method in locations lacking both potable water and power, but rich in sunshine and saline ground water or seawater. Production from the solar stills depends mainly on solar radiation intensity, and humidity has no effect on production. A gentle wind is favourable, and production increases with ambient temperature. Depth of saline water in the still and the angle of inclination of the glass cover affect production. Smaller angle and smaller depth increase productivity (expressed as litres/m<sup>2</sup>/day). Either glass or plastic can be used as material for the cover, although glass is often preferred for durability and ease of cleaning. A glass cover with diameter smaller than about 2 m is convenient to reduce breakage. PVC and polythene are not very desirable as covers on account of their shorter life and decreasing transmittivity. With a radiation intensity of 550 cal/cm<sup>2</sup>/day, the annual average productivity of a solar still can be 3 litres/m<sup>2</sup>/day, the productivity being higher in summer and lower in winter.

Many solar stills have capacities in the range of 5 to 10 litres per day. The construction materials required include wood, asbestos cement sheet, aluminium sections, and glass or plastics. For the bottom of the still, a thick, black polythene film spread on an insulating layer is used as liner, and a water depth of 2 to 3 cm can be maintained. In permanent, higher-capacity stills, cement and similar construction materials, including sealant materials (e.g. silicone/tar plastics), are required.

Clean glass covers offer a good surface for rainwater collection, and if sufficient storage is provided, the collected rainwater can supply additional water for use. Places with low rainfall distributed throughout the year are more suitable for such units than areas with heavy rainfall concentrated in certain parts of the year. A few units have been installed in lighthouses, and their satisfactory performance suggests a potential for wider use.

Generally, two types of design have been adopted for the basins of large solar stills: (i) a single, large water basin covering the whole still area (i.e. *pond type*, as adopted in the pilot plant at Dayton beach); (ii) the plant is divided into many units with varying lengths having uniform width (*bay type* construction in Australia, Greece and India). Pond construction is the cheaper type. Although cotton adhesive tape is reasonably durable for about a year or so for glass-

to-glass joints, tar plastic (a product of coal tar distillation) has been found to be more suitable for the purpose. Silting on the surface and algae growth sometimes cause maintenance problems. In the absence of availability of butyl rubber sheets at a reasonable price, and in view of the short life of jute-impregnated asphalt mat-liners and black plastic film, it is necessary to adopt complete concrete or brick masonry flooring with black asphalt coatings for the bottom of permanent installations. In some plants, precast items were used for the top ridge, and bottom supports were combined with rainwater gutter and ridge-supporting pillars. Water vapour leakage is one of the major problems affecting the performance of solar stills during operation. Use of silicone sealant in Australian solar stills has proved to be a solution, but silicone, apart from its very high cost, is not available in many countries.

Costs vary with the types of stills constructed. Generally, for estimates, the efficiency of solar energy utilization is assumed to be 30 per cent, and with the value of average annual radiation intensity, the calculated productivity is taken as the basis for calculation of surface area required for solar stills. The investment cost can be calculated on the basis of cost of construction of unit surface area of stills that collect rainwater and have a water supply tank. The operating cost of the plant can be calculated on the basis of 20 years' life, an appropriate interest rate, 1 per cent of investment as annual operation and maintenance cost, and an additional 100 man days per year per 930 m<sup>2</sup> area. It may also be assumed that 80 per cent of the rainwater is collected. In any given situation, of course, these assumptions may require modification. Since the solar energy is freely available, the interest on capital costs contributes the major portion of the product water cost. The output is independent of salt concentration in the feed water. Regarding increases in labour and materials costs, the capital cost per m<sup>2</sup> increased in India from \$US 7.50 in 1966 to \$US 11.50 in 1975, including the cost of storage tanks.

Attempts have been made to improve the yield of product water per unit area with the use of green dyes for evaporation enhancement in India, and with the use of industrial waste heat in Australia and Canada. Further development should enable these results to be applied in stills under different conditions.

Solar radiation is the principal energy source for salt farms, which treat seawater/inland brine in three stages to produce common salt: (i) reservoir (3° to 6° Baume) wherein seawater is taken in, (ii) condensers wherein brine is concentrated to precipitate out calcium salts, and (iii) crystallizers (24° to 29° Baume) wherein common salt is precipitated. The

area required in the manufacturing process is high, e.g. nearly 35 per cent of the area will be used for reservoirs, 45 per cent for condensers, and 10 per cent for crystallizers. The exact area requirements are determined by the rate of evaporation and reduction in volume at various concentrations of seawater/brine. For every ton of salt produced, 45 m<sup>3</sup> of water must be evaporated. Evaporation depends mainly on the intensity of solar radiation, meteorological variables like air temperature and humidity, direction and velocity of wind, number of cloudy and rainy days, and total rainfall. The evaporation rate decreases at higher densities of brine; this rate is increased by operational variables such as decreased brine depth and addition of green dyes. The mother liquor (bittern) can be processed to obtain fertilizer-grade potassium chloride or pure potassium chloride for industrial uses, as well as bromine and magnesium salt.

(b) *The humidification — dehumidification (HD) technique* of solar distillation offers significant advantages over the solar still in terms of efficiency in use of solar energy, and space requirements. The principle consists in using solar energy (or waste heat) to heat the feed water, spraying the heated water through a packed tower against an airstream blown up from the bottom of the tower, stripping off the vapour from the airstream at the top of the tower by means of a condenser, and recovering the condensed water. HD requires power for blowing the air and for spraying heated brine at the top of the packed tower. The solar energy collector consists of a shallow, rectangular tank containing feed water over which a transparent plastic sheet is laid, and the heated seawater is pumped to the top of the packed tower; feed water heated by other means, such as industrial waste heat, can be fed directly to the top of the packed tower. There is scope for reducing the cost of initial investment by design improvements in the tower, selection of common construction materials, use of the multiple-tower system for high capacity, and also with higher operating temperatures.

### 3. Cooking

Efforts to design and introduce solar cookers have for many years concentrated on two main types: the cooker with a fixed-plane collector, and the cooker with a spherical/parabolic mirror of average precision. Operating temperatures can exceed 400°C. A number of materials can be used, namely, glass plastics, aluminized plastics, steel or aluminium. Taking into account the conditions of use and aiming at a cooker of reasonable working life (five years or more), and adequate versatility for the types of cooking which are feasible, research has tended to favour the cooker with a parabolic mirror of polished aluminium, the detailed

design being subject to variation (moulded in plastics or artificial resin or constructed entirely from metal). In India, a concentrator-type solar cooker was developed which essentially consists of a parabolic disc of about 1 m diameter made of aluminium sheet with a reflectivity of 75 per cent, a stand being provided at the focus for the cooking pot. An Israeli version used mirrors of very pure (99.98 per cent) aluminium electrolytically polished and anodized as recommended for streetlight reflectors, with a life or more than five years, but at a higher cost. As the cost of these units was too high to be used economically in developing countries, a great deal of work has been done in the United States of America and Israel in an attempt to reduce the per-unit cost by substituting less expensive materials. Recent efforts have been directed toward making an umbrella-type solar cooker using aluminized plastics; these can be folded and kept indoors when not in use. Figures 3 and 4 illustrate the box and parabolic mirror types of solar cookers.

Units with an area of 1 to 3 m<sup>2</sup> for solar radiation collection with diameter 1 to 2 m and power ranging between 0.7 and 2.0 kW seem well suited for family cooking and pose no insurmountable problem in production. Different investigators give cost prices for mass production ranging from \$US 10 to 20. Another estimate for a parabolic cooker of diameter 1.5 m is about \$US 30, which could be brought down to \$US 22 if mass produced.

The effectiveness of a solar cooker can be enhanced by coupling with a heat storage system. The heat storage must be provided in a volume small enough so as not to shadow an appreciable part of the solar collector, and of weight small enough to be supported on the grill. Insulation must be sufficient to prevent serious loss of heat during solar exposure. It must be capable of storing heat equivalent to one kWh or more at a temperature high enough to permit effective cooking later. It is desirable to be able to regulate the rate of heat release for cooking. These requirements are not easy to meet.

Although quite a few designs are functionally satisfactory, there are not very many solar cookers in use. The main reasons stem from (a) social habits, (b) technical drawbacks, and (c) inadequate promotional efforts. Among the socio-economic factors inhibiting the large-scale utilization of solar cookers, initial investment cost is one obstacle to the purchase of a solar cooker. Families in rural areas can gather wood and cow dung for fuel for conventional cooking. Furthermore, solar cooking involves alteration in the household routine, since the housewife must prepare the evening meal during daylight, well before the traditional time, which incurs the additional problem of keeping the food hot. Secondly, the housewife must remain in the hot sun while cooking. As the

community becomes able to acquire kerosene or electric facilities, solar cooking might not be considered. The application of solar cookers appears to be limited mainly to the low-income group and poor communities with no alternative fuel and who are prepared to have their midday meal as the major meal. Nonetheless, considerable promotional and extension work is involved, preferably undertaken by government and local authorities. A promising approach to overcome the difficulties is to combine the introduction of solar cooking with other programmes for rural development (e.g. education, public health, cultivation techniques and home economics). Such an integrated approach should help to bring solar cooking into general use in countries with a tropical climate; the resulting advantages appear so extensive in social and geographical terms as to justify the necessary effort.

#### 4. Solar drying

Solar drying has been used for agricultural and other products since time immemorial. The traditional techniques, though cheap, often yield inferior products, and cleanliness cannot be ensured. By applying modern technology to solar drying, substantial improvements can be made. Products traditionally dried by solar energy include various kinds of vegetables and fruits, palm nuts, copra, soya bean, meat and fish. The systematic application of modern solar drying to carefully selected, high-value goods for export or for consumption by high-income people should lead to clean and refined materials, substantial reduction in weight, and improved preservation and taste. These factors can have a major influence on marketing.

Solar drying systems can be classified mainly on the basis of the mode of heat transfer employed, i.e. radiation or forced convection (free convection is present in both cases). The type of heating collector employed, the availability of thermal storage during sundown hours, the transport medium and its circulation, and the rate of drying are important for operational and cost efficiency.

*Radiation driers* have a common space for collecting solar energy and for drying the product (figure 5). There are holes in the bottom and top of the space to allow for ventilation of evaporated moisture. The materials for drying are spread thinly in trays, usually at one level, and exposed to direct radiation from the sun. There are no controls beyond adjusting the orientation. The area per unit weight of the product may be calculated from the heat-balance equation for different products, but often the average area per unit weight is calculated and used in the design. Such driers are easy to manufacture on a small scale, and have been used for drying copra in Fiji, grapes in the USSR, France and Australia, corn and yarn in the

United States of America and the West Indies, and a number of products in Turkey and Middle Eastern countries.

*Convective driers* have separate areas for collection of solar energy and for drying the product. Heat can be transferred from one area to the other by air or by water. In the latter case, a heat exchanger is used, and storage or supplementary heating may or may not be provided. The collectors, mostly the flat type, have features in common with solar heating. A two-stage drier, using an inflatable collector coupled to a mobile van has been field-tested at Barbados by the Brace Research Institute of Canada. A solar kiln for seasoning timber, using separate air heater and rockbed thermal storage, is under development in Australia; a similar kiln, without storage, is under trial at the Forest Research Institute, India (see also reference S 4).

Where other supplementary power is not available, a windmill can be added to a drying system for circulating air. Thermal chimneys are also possible, with the difference in density of the heated air inside and the cooler air outside creating an upward movement of the enclosed air, but they must be tall to obtain sufficient difference in air temperature, and large in cross-section to prevent undue resistance to the flow of air.

Extensive developmental efforts are required for heat-storage devices, collector-drier combinations and flat-plate air-heaters to supply hot air to driers.

#### 5. Pumping

Among the possible uses of solar energy, the lifting of water for drinking or irrigation purposes is of interest in dry regions and other rural areas, particularly where underground water is available at a depth not exceeding 30 m. Requirements of small-scale irrigation and domestic purposes will be well within the reach of solar energy pumps in the fairly near future. A pair of bullocks working continuously can raise 1 m<sup>3</sup> of water per hour from a depth of 30 m. The equivalent of this work can be done by an electric motor pump rated at 0.8 kW, for which a solar pump can be designed.

Solar pumps can be operated with solar energy directly converted into electricity, or by using thermal energy itself to heat a working substance which may operate the engine. The direct conversion of solar into electrical energy does not at this stage seem to be an economic proposition. However, solar pumps run by thermal energy from the sun have been constructed in France, the United States of America, the USSR and Israel. In these pumps, flat-plate

collectors have been used for raising the temperature of the working substance. A solar pump developed at the University of Florida in the United States of America has two check valves with no moving parts. A boiler is connected by straight and U-shaped tubes to a chamber with check valves at the inlet and outlet. The liquid in the boiler is vaporized by pushing the liquid out of the system; when the vapour reaches the bottom of the tube, it suddenly streams into the chamber filled with cold liquid where the steam rapidly condenses. While the steam is produced, the top check-valve is open and the liquid is pushed out. When the vapour condenses, the valve closes due to the low pressure created, and the bottom check-valve opens to let in more liquid to be transported. The SOFRETES Company of France has developed a solar pump which consists of the heating circuit where the water is heated with the help of solar radiation, and the fluid circuit wherein the hot water passes through the tubular heat exchangers where heat is given to a volatile liquid. The colder water then returns to the heating circuit. The working fluid, in gaseous form at high pressure, leaves the heat exchanger and expands in the piston motor, and passes into a condenser cooled by the pumped water. The gaseous fluid is liquefied and is returned to the heat exchanger by a reinjection pump driven by the engine itself. In the final phase, the pumped water circuit, the engine drives a hydraulic press which operates

a pump immersed in the water in the well. The SOFRETES pump is illustrated in figure 6.

The working fluid is low-boiling point methyl chloride. Several different models of the solar pump have been made and tested. Some of the main characteristics of these pumps, and test locations, appear in the following table. In addition to these, further exhaustive trials in the village areas of the Republic of Chad show that such pumps can lift water up to a height of 60 m or more. One of the main features of SOFRETES solar pumps is that the components can be manufactured in the user country. This type of pump has been in service at the laboratory of Dakar University, Senegal, since 1969, and has functioned without any trouble. Similar solar pumps have been used by farmers in Israel. In addition to methyl chloride, a wide variety of fluorinated organic compounds including freons can be used at lower temperature ranges (reference S 5). The average cost of the SOFRETES pump is about \$US 22,000 for 0.3 to 0.5 kW. Solar engines of the Thermoelectronic Corporation of the United States of America cost \$US 20,000 in 1972 yielding 2 to 5 kW. Undoubtedly, mass production could reduce prices considerably. Nearly 50 per cent of the cost is the collector. Another type of pump, based on the Stirling cycle, is described in reference S 6. Solar pumps for lift irrigation are under development in India (see reference S 7).

	<i>Nadie</i>	<i>Onersol</i>	<i>Senegal</i>	<i>Quara</i>	<i>Chinguetti</i>	<i>Secra</i>
Collector area (m <sup>2</sup> ) . . .	12	60	88	30	88	6
Rate of pumping (m <sup>3</sup> /hour) .	1.2	10	6	2	10	0.6
Height (m) . . . . .	15	12	25	20	20	14
Speed (rev/min) . . . . .	180/150	100/150	100/150	100/150	100/150	80

Availability of small and medium-sized units (corresponding to a fraction of 1 kW to several kW) at reasonable production costs, e.g. \$US 1,000 to 1,500 per kW installed, could provide the basis for economic and social changes, but it does not seem possible that this goal can be achieved unless the developing countries themselves participate in the process of research, development and industrial production.

## 6. Refrigeration and air-conditioning

In many tropical and developing countries, a substantial quantity of foodstuffs cannot be preserved and spoils. For some foods, refrigeration is required; and, for areas without electricity, solar refrigeration and/or solar cooling may well be the answer.

The coldness from night-time air can be stored and, in some areas, produced by radiation to the night sky. In dry climates, cooling can be effected by evaporating water from cloth wicks. In moist climates,

the moisture in the air can be partially removed, and the dried air cooled by evaporation of water. Most cooling systems depend on the evaporation of a liquid in a closed system. The household refrigerator works on the principle of alternate vaporization under reduced pressure, and condensation under increased pressure, of a fluid such as ammonia or freon. Vaporization extracts heat from the surrounding environment and cools the refrigerator cabin, or freezes water to ice; the system is regenerated by compressing the vaporized working fluid to liquid, the heat produced being dissipated to a stream of circulating air or water; the two operations of cooling and regeneration are combined into continuous operation.

Solar energy could be used to operate a heat engine, which in turn can operate a compression-type refrigerator or air-conditioner. The solar engine has, however, low efficiency for producing power. It is usually simpler and cheaper to use the sun directly in an absorption-desorption cycle for the purpose. A



number of systems (e.g. ammonia/water, ammonia/sodium thiocyanate) could be used. Figure 7 shows refrigeration using an ammonia/sodium thiocyanate system.

For the purpose of refrigeration and producing ice, the weight proportions of ammonia and water are in the ratio of 1:1.3, and the maximum heating temperature is about 130°C, with a special valve separating the water from the liquefied ammonia; the over-all coefficient of performance (COP), i.e. the heat absorbed by vaporizing coolant, divided by solar heat incident on collector, is about 0.10. Flat-plate collectors can also be used for the system, in which case the COP is further reduced. The ammonia/water system has the disadvantage that some of the water vaporizes with ammonia, requiring a rectifying arrangement for separation, and at intervals the water must be returned to the larger vessel containing ammonia/water solution. It is desirable to eliminate water, which can be done by using very concentrated solutions of salt in liquid ammonia. The vapour pressure of liquid ammonia can thus be reduced at room temperature from 10 atmospheres to less than 1 atmosphere, and the salts have negligible vapour pressure even at high temperatures. Ammonia/sodium thiocyanate solutions have suitable thermodynamic properties with very high solubility, low vapour pressure, and high heats of vaporization; they are chemically stable and inert, comparatively inexpensive and can be used in steel vessels; they have high heat conductivities and low viscosities. The COP of this system is approximately three times that of the ammonia/water system. Although solar refrigeration is normally more expensive than refrigeration with ordinary fuel or electricity, it can be considered where electricity and fuel are very expensive or unavailable, as in many rural areas of the developing countries.

Large industrial refrigeration plants can have a COP as high as 0.7, but smaller plants are less efficient. If household labour for domestic cooling is considered free, small solar cooling units may be viable, but operation of a solar cooling machine is fairly complicated, requiring experience and skill in mechanical operations. In view of this, solar cooling and ice production as a village industry may be more practical than individual hand-operated domestic solar refrigerators in homes. One of the difficulties in ice production is the slow growth of ice crystals, and it may be advisable to operate several regeneration units while the sun is shining, and carry out the freezing operations at night.

There is great demand for air-conditioning in hot climates, and air-conditioning by solar energy is technically feasible. In a typical flat-roofed, one-storey building, much of the roof area would be covered with

solar collectors, and capital investment would therefore be high.

The characteristics of water make it satisfactory for cooling and air-conditioning. A lithium bromide/water system can be used for cooling in that the absorption of water vapour by concentrated lithium bromide solutions produces cooling in the same way as the ammonia/sodium thiocyanate system. This system is well suited to solar operation because it can be regenerated with hot water above 77°C, but below the boiling point of water. With indirect heating through a heat exchanger, it is possible to have extra heat storage for cloudy weather. The average COP of such a system is about 0.18. At very low temperatures, lithium bromide may crystallize, but this can be prevented by temperature control. The general trend of results with such a system is such that, on a bright, calm day, a solar collector of 20 m<sup>2</sup> should produce one ton of refrigeration. Improvement in collection efficiency by a selective surface like nickel black may reduce the collector area.

Dehumidification in moist hot climates is almost as important as cooling. Removal of moisture from the air is much easier to achieve than cooling the air, and dehumidifiers operated by electricity are cheaper than air-conditioners. Active silica gel has been used for the purpose, followed by regeneration. In hot, dry climates, air can be cooled by evaporating water, and it is common practice to blow air through coarse cloth saturated with water. Even in humid climates, considerable cooling can be effected by dehumidification of the air followed by evaporation of the water and restoration of part of the humidity. Such dehumidification can be effected by an ethylene glycol/air/solar collector system, as proposed by the University of Wisconsin, United States of America, whereby moisture in the air is absorbed by passing it through a spray tower of falling drops of ethylene glycol, the non-volatile glycol absorbing water and giving drier air, and the glycol being regenerated with a stream of hot air heated by the sun.

Cooling of houses can be achieved in hot, clear climates by radiation to the sky during the night, using a black cloth radiator; such a radiator may act as a solar collector for heating during day-time. Large buildings, such as hospitals, factories and schools, may be fitted economically with roof-mounted, combined solar heating and radiative cooling systems, in which the same panel operates as a collector during day and a radiator at night, using separate storage.

As a supporting activity to space heating and cooling, considerable work has been done on the study of indoor temperature as a function of architecture, orientation of the building, insulation, shading and selective paints. A detailed consideration of these

factors can considerably reduce the load on the heating and cooling system that may be developed. One alternative system for residential heating and cooling is illustrated in figure 8. A number of experiments involving the absorption cooling cycle have been conducted in the United States of America, Australia, the USSR, France, Japan and other countries, and have shown that the concept is fully feasible, but considerable design engineering works will have to be done before the system can be used widely.

A convective cooling system, using lower wet-bulb temperatures at night and coupled to rockpile thermal storage, is under development in Australia and India as a component of a hybrid heating-cum-cooling system. Comparative studies of economics and reliability of the rockpile and natural air-conditioning systems need to be undertaken for hot, dry climates, and their areas of application specified.

## B. GENERAL CONCLUSIONS AND SUGGESTIONS

There has been considerable work in many countries of the world on low-grade thermal devices, such as solar water-heaters, solar stills, driers, space heating, refrigeration and air-conditioning, and pumping. Except for water-heaters and solar stills, which are commercial propositions in some developed countries, other devices have not found any large-scale utilization mainly because of their high cost and low efficiency.

(a) *Solar water-heaters*: Data on commercially available solar water-heaters of small, medium and large capacities should be widely disseminated with a view to selection of appropriate types. Steps should then be taken to encourage their production and use. Governments might assist in setting up demonstration units in representative locations.

(b) *Solar stills*: Similar approaches should be made for solar distillation, including small, portable equipment. In addition, there is scope for improved means for trapping the water vapour which escapes during salt production (the HD principle can be used for this purpose).

(c) *Solar driers*: Programmes might be developed to make solar driers useful for drying agricultural products through demonstration units and other promotional efforts.

A recommended design for a solar timber kiln should be developed, and a few such kilns fabricated for typical locations.

(d) *Cooking*: Extensive promotional activities should be initiated in rural areas; simultaneously, suitable storage device and heatpipe systems need to

be evolved for coupling with the cooker to remove certain short-comings.

(e) *Solar space heating and cooling*: A pilot programme for introducing solar heating in a few selected villages and at high-altitude areas should be undertaken.

For preservation of food materials, a few prototype ammonia/water solar refrigeration units should be set up in remote rural areas for developmental investigations. More extensive developmental investigations should be carried out for use of the lithium bromide/water system in solar air-conditioning.

(f) *Pumping*: The SOFRETES solar pump should be tried out in selected rural areas, and developmental investigations for its adoption undertaken, using indigenously available materials.

## II. SMALL- AND MEDIUM-SCALE CONVERSION TO ELECTRICAL AND MECHANICAL POWER

The possibilities which have been explored, and which have proved rewarding for small-scale and medium-scale applications, are solar engines, and turbines working on the Rankine cycle, producing mechanical power, and various solar photobatteries and thermobatteries for conversion into electric power, and solar ponus.

A solar thermal power unit is similar to any conventional, external heat engine, except that the heat is provided by solar collectors. High-temperature units use focusing collectors that have to follow the sun, and in general such collectors are expensive and difficult to maintain. To avoid the complications of sun-following devices, many types of stationary collectors have been proposed: the flat type as used for water heating, or very low-concentrating mirrors limited to a concentration factor of 2 or 3. Such collectors generally produce relatively very low temperatures, thereby resulting in much lower thermodynamic efficiency of the heat engine; but the system is simple. Apart from the cost of the collectors, and the preparation of the ground site on which these are erected, the absence of a satisfactory and cheap solution to the problem of solar heat storage greatly increases the capital cost of installation.

### 1. Solar engines

Many designs of solar engines, both piston and turbine types, have been proposed, and several have been demonstrated, but they have not yet been produced commercially. Investigations are currently being carried out in Israel, Italy and the United States of America.

## 2. Thermoelectric conversion

Thermoelectric conversion methods may be used for converting solar energy into electricity directly. Thermobatteries with semiconductors of antimony, bismuth tellurides, selenium tellurides, etc., are being produced on a large scale, and have an efficiency of thermal energy conversion of 6 to 7 per cent. This thermoelectric process requires concentration of normal solar radiation, and thus requires development of a cheap concentrator; a heat storage device is also required. Solar thermobatteries have a number of small-scale and medium-scale applications with production of power in the range of a few watts to a few kilowatts, particularly for power communication apparatus.

## 3. Photovoltaic power

In photovoltaic power generation, a voltage is produced at a metal/semiconductor junction. Arsenic-doped silicon and boron-doped silicon semiconductors can be used to form a good junction for the purpose. Currently, silicon cells have an efficiency of about 10 to 12 per cent, but this can be improved by special processing and increasing the purity of the material, and an efficiency of conversion in such cells as high as 30 per cent has been predicted. Conversion efficiency of a solar cell is a function of the geometry of the cell, and increases with its thickness. Silicon cells are used in space ships, but the cost is at present prohibitive for terrestrial applications.

Cadmium sulphide (CdS) is a good photovoltaic material, and efficiency up to 7 per cent has been attained; this seems to be more attractive for relatively high-temperature photovoltaic cells, but it appears that there is some amount of degradation at higher temperature. Nevertheless, efforts are in progress to use it in combination with other materials. A cross-section of a typical cadmium sulphide/copper sulphide solar cell is displayed in figure 9. The main advantage of the CdS cell is that it can be made from microcrystalline thin film rather than single crystals; the cells are capable of being manufactured continuously by vacuum deposition of the materials on plastics. Gallium arsenide is also a good photovoltaic material, but it is not abundant. Cadmium telluride is another good photovoltaic material with potentially a much higher efficiency, but its manufacture and availability pose problems. Technological developments are in progress to prepare cells of this from both single crystals and thin films.

In recent years, organic semiconductors have been investigated in development of photovoltaic cells. Organic dyes and such materials as magnesium phthalocyanine have been used in organic photovoltaic

cells. A chlorophyll semiconductor photocell is promising.

## 4. Solar pond

In principle, the solar pond is a convenient device for collection and storage of solar heat. It comprises half a hectare or more in area, with a blackened bottom overlain by layers of concentrated saltwater, above which is placed, without mixing, a layer of pure water. The lower salt solution is heavier than the upper water and does not mix with it; when the bottom layer becomes heated, it does not rise to the top. Thus, the upper layer of water remains cool while the lower layer heats up to 90°C or more. A low-temperature steam turbine is operated by a boiler placed at the bottom of the pond.

As a collector for low-temperature heat, the pond is very much cheaper per unit area than the conventional solar collector used for water heating, since no metal, plastic or glass is used in its construction. Despite low efficiency, a low-temperature turbine can be used to produce small power. Depending on the investment needed in the construction of the pond and its plumbing, the estimated cost of power produced would be about 2 US cents per kWh. Thus, for the supply of power from smaller sources, especially in remote rural or coastal areas, the solar pond appears to be a feasible proposition. The solar pond can be coupled with production of common salt from seawater, particularly in areas of heavy rainfall. Israel, Australia and Canada have done extensive work in that field. Although the heat extraction problem in solar ponds has substantially been solved, there remains the mixing problems of the layers of the pond: chemical engineering studies need to establish for each case the proper design to yield the desired amount of low-temperature heat, power and salt.

## III. LARGE-SCALE POWER PRODUCTION

### 1. Solar power via satellite

For any practical use of solar energy for large-scale power production, the two main and basic hurdles to be overcome are (a) atmospheric reduction of the intensity of solar radiation, and (b) storage of the solar energy. A concept evolved in the United States of America to overcome both those hurdles, known as the Satellite Solar Power System, envisages that a satellite synchronized with the earth's movement outside the geosphere would transmit solar power to receiving stations on earth for conversion into electrical power (see figure 10). In such an orbit, solar radiation would be received continuously and would be of an intensity on an average six times that on the earth's surface. Solar batteries would convert it into

electricity, which in turn would be converted to microwaves for transmission to earth where it would finally be reconverted to electric power. The tentative cost estimate for a system of 5,000 MW is \$US 1040 per kW.

## 2. Photothermal conversion

Use of selective surfaces of high absorptivity (very thin film of silicon and silver) and low emissivity, on the exterior of steel pipes in evacuated glass envelopes and operating at elevated temperatures, has been proposed as a concept of thin-film photothermal conversion of solar energy for power production. This concept mainly comprises a solar collection area, a thermal storage, a heat exchanger, a boiler, and a power plant. Liquid sodium has been suggested as the thermal fluid, but some organic fluids and salt eutectics could also serve the purpose. Concentrating collectors in the solar farm with high absorptivity/emissivity ratios of 10 to 15 could give temperatures in the range of 350° to 550°C; or flat-plate collectors with no concentration but with high ratios of 20 to 40 could give a temperature of 250° to 350°C. Economic projections have been carried out for a collector area of 1 km<sup>2</sup>, to produce 80 MW.

## IV. OTHER FIELDS OF SOLAR ENERGY USE

A number of other applications or suggested systems have not been elaborated here, either because they are not as yet directly relevant to the conditions in developing countries or because they are as yet theoretical.

### 1. Energy plantation

The recent concept of an energy plantation covers the planting of fast-growing, woody plants or trees which have a high photosynthetic efficiency. The trees would be harvested, cured in direct sunlight, and burnt to produce power. Investigation is still required on technical and non-technical aspects.

### 2. Controlled environmental greenhouses

At the Environmental Research Laboratory of Tucson in the United States of America, vegetables are grown in the controlled environment of an air-inflated, plastic greenhouse. The large-scale Puerto

Pinasco (Mexico) greenhouse experiment, designed on the same basis, produces similar results. The experiment has now been extended to Abu Dhabi, and has started operation. Such greenhouses have real possibilities for many developing countries.

### 3. Algal ponds

Fuel derived from pond-grown algae can drive gas turbines and reciprocating heat engines. The potential of algae for fuel is about the same as for higher plants. When growing in conditions in which ample carbon dioxide and suitable nutrients are provided, the process of repeated subdivision provides large quantities of organic matter. When the energy potentially available in the dried algae is related to the solar energy incident upon the growth tanks, it has been shown that up to 8 per cent can be recovered.

### 4. Solar furnaces

Solar furnaces which give a very high concentration of focused radiation have been used for scientific investigations. Those with high optical precision give temperatures of over 3,000°C and may cost over \$US 1,000 per m<sup>2</sup>. Such furnaces have been constructed and studied in France (reference S 8), Japan, the USSR, the United States of America and Algeria.

## V. CONCLUDING REMARKS

In each country, there is a need to identify the future role of solar energy. Many solar devices depend heavily on the collector system, and there is a continuous need for testing and scientific assessment of collectors with a view to using local materials for construction.

There is scope for immediate transfer of technology on small-scale special purpose uses of direct energy conversion processes, and this will assist future transfer of technology on larger-scale processes.

For effective utilization of solar energy in the region, a broad spectrum of activities will be required, involving existing and new research and development institutions, scientific training, educational and promotional activities, and dissemination of information, and ESCAP is well qualified to lead and co-ordinate national and regional efforts in these respects.

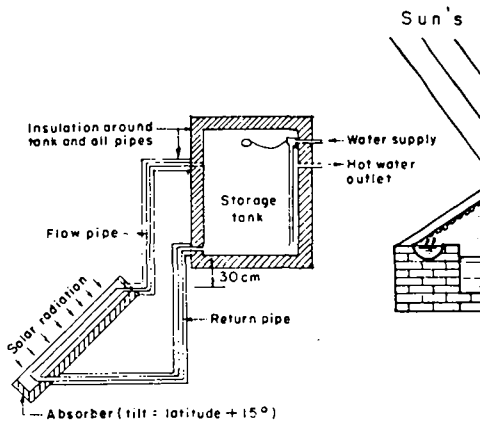

Figure 1. Domestic solar water heater

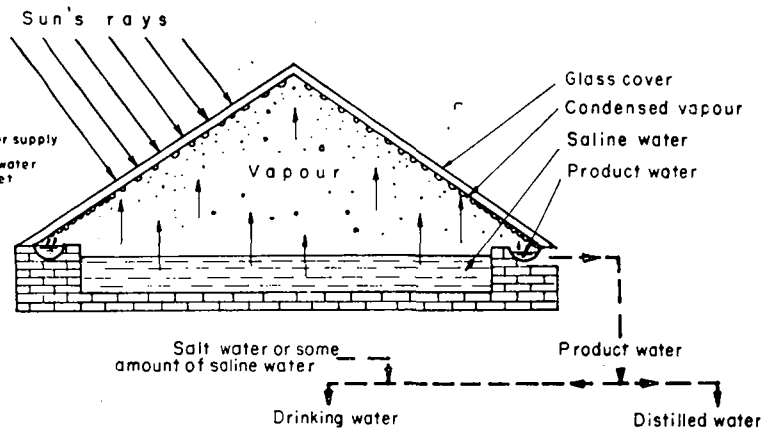

Figure 2. Solar still for water desalination

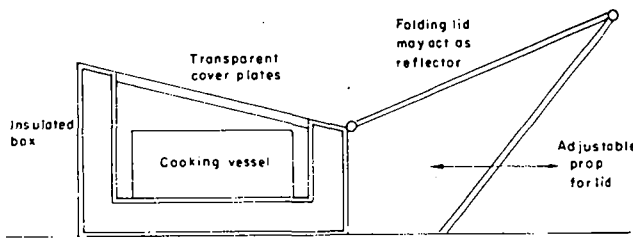

Figure 3. "Hot box" type of solar cooker

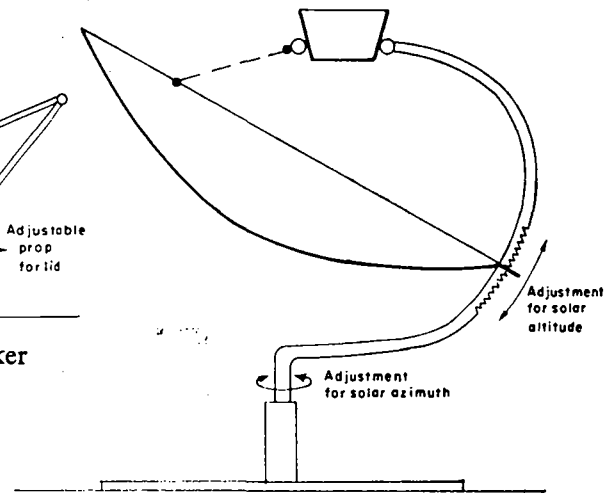

Figure 4. Solar cooker with parabolic mirror

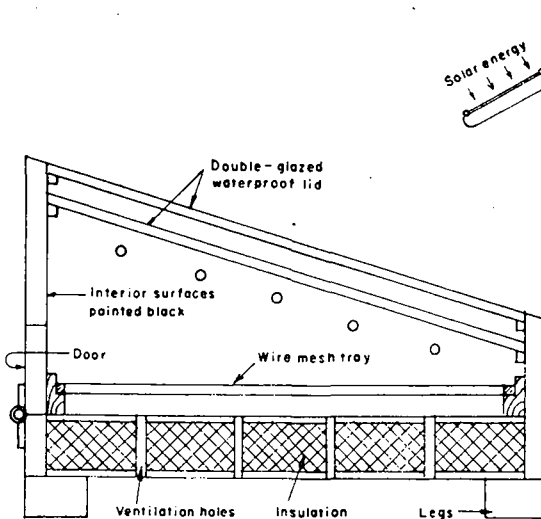

Figure 5. Tray-type solar drier

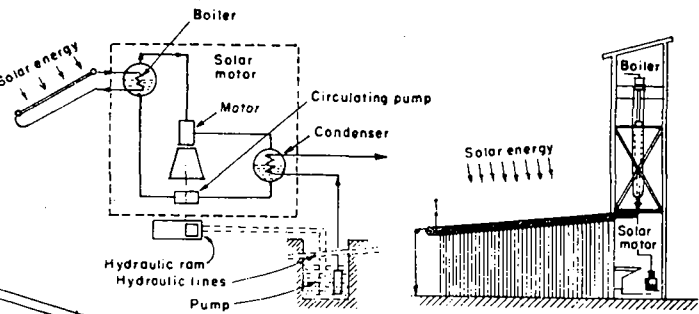

Figure 6. Solar pump (SOFRETES type)

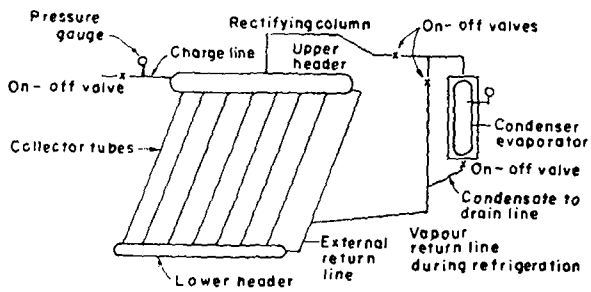

Figure 7. Refrigeration system (ammonia/sodium thiocyanate refrigerant)

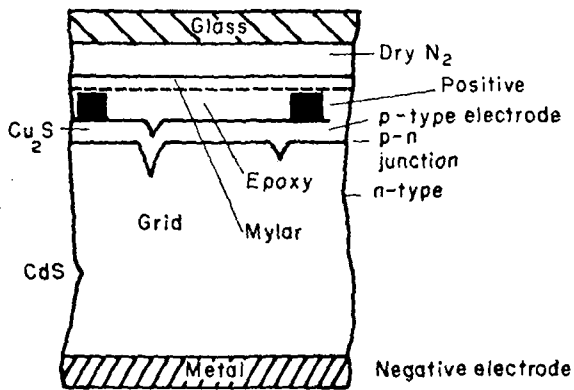

Figure 9. Cross-section of typical CdS/Cu<sub>2</sub>S solar cell

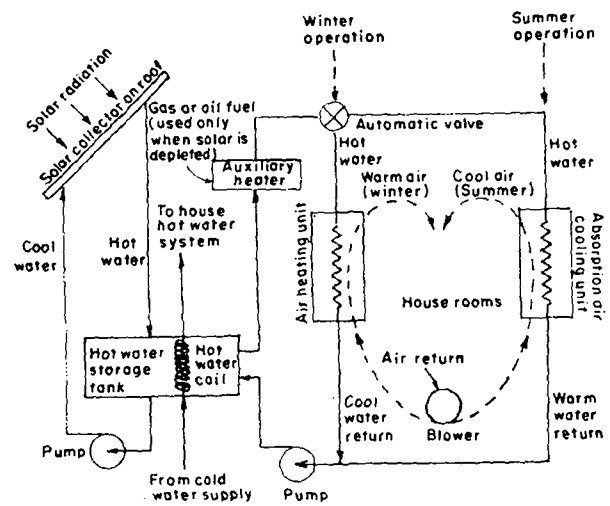

Figure 8. Residential heating and cooling

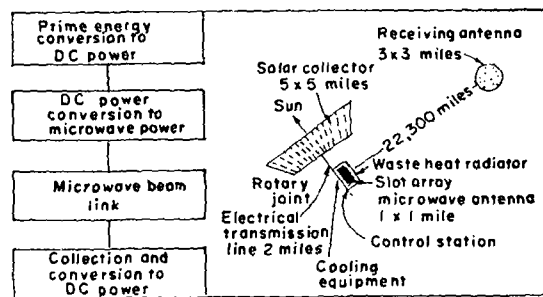

Figure 10. Satellite solar power system

## II. INFORMATION PAPERS PREPARED BY PARTICIPANTS

### SOLAR ENERGY RESEARCH IN THE PHILIPPINES (NR/ERD/EWGSW/CR.1)\*

by

Mr. E. N. Terrado (Philippines)

In spite of the announcement that the national goal of the country for future power development would centre around nuclear reactors, geothermal and hydro-electric potential, alternative sources of energy, such as solar energy and wind energy, were given an important place in national energy planning. However, the absence of pertinent survey data makes it difficult to determine the exact role to be played by these sources in the energy picture for the next 25 years or so. Extensive survey work is therefore necessary in the Philippines, as in other countries of the region.

Low-grade heat derived from solar devices has considerable and immediate possibilities in the region. Such devices comprise: (a) refrigeration for the preservation of vegetables, fish and other materials on a sub-community scale; (b) water heating for schools, hotels, hospitals, etc.; (c) pumping for irrigation; (d) drying of agricultural products; and (e) distillation for potable water and other specialized uses such as water

for lead-acid batteries. Developmental efforts are to be made for adoption of the devices in many of the countries of the region. In the long term, the development of large-scale power production from solar energy will benefit both the developing and the advanced countries, and collaboration should be established on regional and international levels.

At present there are four ongoing research projects in the country, related to: (a) solar engine for agro-industrial purposes, water heating, distillation, and refrigeration, work on which commenced in 1974; and (b) flat-plate collectors and ammonia absorption-desorption system for the development of an ice-making machine. The National Science Development Board is considering financing for other projects, namely, a drier for lumber, solar-powered open-cycle gas turbine, and silicon cells. It plans to establish a National Energy Institute in order to co-ordinate all research on non-conventional energy sources. The country is in need of a chain of solar radiation stations to record solar radiation data.

\* Summarized.

### SOLAR ENERGY IN INDIA: RESEARCH, DEVELOPMENT AND UTILIZATION (NR/ERD/EWGSW/CR.2)\*

by

Mr. C. L. Gupta (India)

#### A. DEVELOPMENT OF SOLAR ENERGY IN INDIA

Systematic efforts to harness solar energy were initiated in the early 1950s. Since then, the various laboratories have concentrated on low-grade thermal processes, such as solar water-heating, solar distillation, space heating, solar drying and solar cooking. From such research, useful data have been made available for indigenous flat-plate collector design and technology (references S 9 to S 11). However, social non-acceptance of the technically successful solar cooker developed by the National Physical Laboratory practically closed all financial and scientific support to solar work until 1962. This scepticism remained until

the 1972 Stockholm United Nations Environmental Conference. Since that time, an expert panel has been constituted in the Ministry of Science and Technology (reference S 12), and open, enthusiastic support has been given by the Prime Minister in an attempt to find a place for solar energy in the country's energy economy. Solar water-heaters and solar stills are now manufactured and sold commercially.

Specific fields of investigation have now been defined by the Government as priority sectors which are to be developed at least to the demonstration stage (reference S 12). In addition, work in the areas of solar cells is being funded. The greatest stress is on power for domestic use, cottage industries and agricultural areas, being developed according to the scheme below.

\* Abridged.

- (a) Rural sector (villages with a population of less than 1,000)
  - (i) Water pumping
  - (ii) Drying of agricultural produce (e.g. food grains, forest products)
  - (iii) Conversion of brackish water into potable water
  - (iv) Use of solar slurry heaters for integrated bio-gas plants
- (b) Urban sector (small towns with a population of 1,000 to 10,000)
  - (i) Mini-power plants (10 kW — 50 kW size)
  - (ii) Solar water-heaters (domestic size)
  - (iii) Space heating and cooling, mainly for health centres, tourist bungalows, etc.
  - (iv) Solar ice-making for fisheries, health centres, etc.
- (c) Metropolitan sector (cities with a population exceeding 0.5 million)
  - (i) Solar cells for television, radios, etc.
  - (ii) Bioconversion of waste into transportable fuels
  - (iii) Process steam
  - (iv) Factory heating and cooling
  - (v) Solar water-heaters (large size for cafeterias, hotels, etc.)

During 1974, in the wake of the oil price crisis and the publication of the report of a solar energy expert panel, the idea that large industrial concerns should sponsor or conduct in-house research and development projects became policy, and the Government permitted all expenses incurred on solar applications in industry to be treated as research expenses.

Solar research and development in India is supported by a network of radiation stations run by the Indian Meteorological Department (reference S 13). There are 26 such stations, 13 of which are principal stations measuring global, diffuse, normal beam radiation and hours of sunshine. The remainder are ordinary stations measuring global radiation and hours of sunshine only. Most principal stations use Moll-Goczynski pyranographs, Eppley pyroheliometers and Campbell-Stokes sunshine recorders, while most ordinary stations use bimetallic pyranographs and Campbell-Stokes sunshine recorders. All these instruments are manufactured in India under licence or with indigenous designs.

## B. PRESENT STATE OF SOLAR ENERGY IN INDIA

### 1. Solar pumping

Eight institutions are currently working in this topmost priority area.

(a) *1 kW and 4 kW solar pumps using flat-plate collectors and organic-fluid Rankine cycle* (Auroville Centre for Environmental Studies, Pondicherry). A 1 kW pump is being designed as the intermediate stage of a project to be completed in 1978. In addition to pumping, solar collectors are meant to be used as part of farm building roofs which could heat air to dry agricultural produce. Also, the solar pump is meant to be coupled to a low-speed generator/compressor to produce power/cooling on non-pumping days.

(b) *Low-temperature direct-contact vapour pump for lift irrigation* (Birla Institute of Technology, Pilani). The vapour pump uses flat-plate collectors and an organic-fluid vapour (immiscible with water) in direct contact with water. Feasibility studies and cost analyses for heads up to 30 m with a capacity of 100 m<sup>3</sup>/day have been completed. Prototypes are being developed for both air-cooled and water-cooled types of pumps. Except for the valves, there are no movable parts in this pump design.

(c) *Medium-temperature 4 kW pump using compound parabolic/wedge stationary concentrators and steam Rankine cycle* (Punjab Agricultural University, Ludhiana). Theoretical and optimization studies have been completed on generating and tracking requirements of compound parabolic/wedge stationary concentrators, designed for a concentration factor up to 3 with monthly adjustment. A small steam engine operating with a head of 5 kg/cm<sup>2</sup> pressure has been fabricated and operated off this concentrator.

(d) *Medium-temperature 200 W hot-air engine using tracking concentrators and Stirling cycle* (Central Salt and Marine Chemicals Research Institute, Bhavnagar). An indigenous version similar to the Philips hot-air engine is planned, to be completed by July 1977.

(e) *1 kW solar pump using medium-temperature, flat-plate collectors and organic-vapour turbine or expander* (National Physical Laboratory, New Delhi). Flat-plate collectors will be developed to operate at 120°C, with an instantaneous efficiency of 70 per cent. Selective windows, selective black-on-copper substrates, and convection suppression by honeycombs will be coupled to a once-a-month adjusting reflector hinged to a double glass flat-plate collector. On the power side, the freon group of organic liquids would be used as working fluids in an indirect system using thermic fluid as a transport medium from the solar collectors and an expander.



(f) *Solar pump using Cds/silicone solar cells* (Indian Institute of Technology and National Physical Laboratory, New Delhi). A long-term project is intended to develop direct conversion of solar energy to electricity by indigenously-fabricated cheap and reliable solar cells encapsulated for long life.

(g) *Fluidyne engine with liquid piston operating on Stirling cycle* (Metal Box (India) with Atomic Energy Research Establishment, Harwell, United Kingdom). Practical commercial development is envisaged for lift irrigation in the field, from small laboratory models pumping 300 litres/hour already developed at Harwell.

(h) *1 kW pump using cylindrical, parabolic, stationary concentrator and steam Rankine cycle* (Jyoti Ltd., Baroda). A leading pump manufacturer of India has undertaken development of a solar pump using conventional solar principles, with a view to mass production.

## 2. Solar drying

Work on small cabinet driers of 5 to 10 kg capacity using a combined radiation/natural convection/storage principle has been in progress in many institutions (reference S 14 to S 20). However, for any significant input to post-harvest technology, the minimum size needed is 100 kg/day for cash crops and a metric ton/day for grain-drying, even for small farmers (reference S 21).

(a) *One ton/day capacity solar paddy drier* (Annamalai University, Chidambaram). Laboratory studies and pilot plant studies in a rice mill have been completed. The pilot plant dries 10 kg/h of paddy by blowing solar-heated air from an air-heater of area 4.25 m<sup>2</sup> with an electrical blower. A prototype is being fabricated.

(b) *Solar kiln for timber drying* (Forest Research Institute, Dehradun). A kiln was designed and developed in 1971-1972 for air-seasoning of timber sections (10 cm x 7.5 cm) used for frames of windows and doors (reference S 22). The kiln is of nearly 10 m<sup>2</sup> area. Drying can be done in 40 per cent of the time taken for normal air-drying, and with 40 per cent of the operating cost of a steam-heated kiln at an initial capital cost of only 20 per cent.

## 3. Conversion of brackish into potable water

Many institutions have experimented with domestic models of solar stills having 5 to 7 litres capacity and 1.5 to 2.0 m<sup>2</sup> area, primarily for supplying distilled water. Recently, figures were published (reference S 23) for explicit multiple correlation of distillate output with three climatic variables: solar radiation, dry bulb temperature and wind velocity.

The major work on supplying potable water has been done by the Central Salt and Marine Chemical Research Institute, Bhavnagar, during the last decade (reference S 24).

A 1,000 litres/day pilot plant was built on the ground in masonry of 1.7 x 2.5 m bays covering a total area of 350 m<sup>2</sup> with glass covers at varying angles. For sealing materials, tar plastic, commercially available in India, was found reliable. The bottom liner was made of masonry plaster covered with black asphalt coating or black cement. For top ridges, bottom supports combined with rainwater gutters and pillars supporting ridges, factory-finished precast items were found best. It has been found (reference S 25) that, if the freshwater source is more than 24 km away and the community requirements are less than 22 m<sup>3</sup>/day, solar distillation is competitive and in some cases even economical. Costs of solar stills-cum-rainfall collection systems are dominated by storage costs because of the prevalent monsoon type of rainfall. In areas of rainfall less than 200 mm/year, solar distillation alone is economical.

## 4. Mini-power plants

There has been a recent emphasis on developing mini-power plants in the 5 kW-50 kW range suitable for supplying electricity to existing tube-well pumps and to villages with populations of 500 to 1,000. A baseline study (reference S 26) for choosing an initial concept for further development of a solar plant has highlighted the need for developing hybrid planar collectors in the range 120° to 150°C and stationary concentrators up to 300°C. Two recent feasibility studies have been carried out (references S 27 and S 28). A 10 kW power plant is being assembled on a collaborative basis with the Republic of Germany.

## 5. Solar water-heaters

Research began in India in 1955 at the National Physical Laboratory (reference S 29).

A mathematical model to predict the performance of a natural circulation system, using a corrugated NPL-type collector or wire-wound pipes with a plate CBRI-type collector, was developed in 1967 (references S 30 and S 31). Both gave comparable performance, but they are costly for an average-income household. In spite of some drawbacks, the industry took up the sale and manufacture of the CBRI design. A recent innovation has been the use of aluminium tube-in-strip panels with built-in headers in collector size of 1.5 x 0.4 m.

Remaining problems in water-heater design and production appear to be solvable (references S 32, S 33, S 34).

## 6. Building heating and cooling

Building heating for high altitudes was tried in 1963 (reference S 35) as a simple extension of the solar water-heater, in which a flat storage tank formed the heating panel inside a high-capacity, well-insulated room, and the results were very encouraging. The use of forced air circulation and a rock pile storage were also tried.

For sophisticated, active cooling systems, the University of Roorkee has developed a one ton capacity absorption air-conditioning system (reference S 36), using ammonia/water as the refrigerant and water from flat-plate collectors. The Indian Institute of Technology, Madras, (reference S 37) has developed an inexpensive system which combines the dehumidification of room air by an absorbent, followed by adiabatic evaporative cooling with the solar desorption of the absorbent in a flat-plate collector open to ambient air.

The systems described above are either for heating or for cooling. But in latitudes between 25° and 35°N, both summer cooling and winter heating are required. A high utilization factor makes such a system practicable, if collectors can form the building roof and ducting can be avoided. This may be achieved in pond-type, low-capacity sheet roofs with movable shades. A thermal design model for this system has been developed (reference S 38) to optimize the operating and design parameters. Another composite system (reference S 39) uses rock beds for heating and cooling.

## 7. Solar ice-making

Recently, an ammonia/sodium thiocyanate system capable of producing 75 kg of ice per day has been developed (reference S 40) with a high design coefficient of performance.

## 8. Solar cells

Thin, wafer-type silicon solar cells from imported silicon crystals were developed with efficiency of 8 to 10 per cent in 1972, but these were very costly. Production of thin-film CdS solar cells, which are reliable, efficient and cheap, is now the major field of development.

## 9. Process steam

Development of suitable collectors is of prime importance in this field, and several institutions are engaged in this activity. Industry supplies the major financial support.

(a) *Medium-temperature flat-plate collectors* (National Physical Laboratory, New Delhi). Stagnation temperatures up to 200°C have been obtained

with flat-plate collectors (reference S 41), using a selective black on copper absorber, a honeycomb of glass tubes and a selectively coated collector window (tin dioxide) to reduce radiation losses. Work has also been started on evacuated-tube collectors which could be mass produced if successful technically and viable economically.

(b) *Medium-temperature planar collectors* (Tata Energy Research Institute Unit, Pondicherry). Truncated, compound parabolic collectors (reference S 42), with a concentration of 4 and a height of 10 cm for receiver size of 3 cm have been designed to achieve 150°C within three hours of the solar noon, when bimonthly adjustments are made. Selective surfaces, coated windows and plastic honeycombs are contemplated to increase the efficiency from the current value of nearly 15 per cent.

(c) *Compound wedge/stationary concentrators* (Punjab Agricultural University, Ludhiana). Compound wedge/stationary concentrators (reference S 43) have been produced as discretized versions of compound parabolic collectors. Efficiencies of 56 per cent have been achieved with a concentration factor of 2.8, and steam has been produced at pressures up to 5 atmospheres. Work is continuing on these concentrators with absorbers in the range of 30 to 40 cm and corresponding heights of the aluminium reflector panels exposed directly to the atmospheric elements.

## 10. Factory heating and cooling

No special problems arise as distinct from building heating and cooling. However, large roof areas of thin elements must be designed as energy generators. A large engineering company has installed a system in which water can be heated by solar energy and air can be blown past hot-water coils mounted on the walls below windows. Water pumps as well as blower fans are needed.

## 11. Industrial drying

Drying of palm jaggery juice, drying of coal fines and spray-drying of baby milk have been explored.

## 12. Solar ponds

Temperatures up to 80° to 90°C have been obtained in shallow ponds; use of this process in salt flats for preheating the water for process steam or for very hot water may soon be undertaken.

## 13. Solar cookers

Step-type reflector cookers have been experimented with, along with steam cookers which can only do limited types of cooking. Solar hot-boxes and ovens

have been developed in many parts of the country; the compound wedge/conical type is original and probably the most successful in terms of lowest cost-per-unit efficiency.

### C. FUTURE PROSPECTS OF SOLAR ENERGY APPLICATIONS

In the national solar energy plan (reference S 12), some of the targets have been explicitly stated. The author estimates, in the light of the last two years execution of this plan, that most of these targets will be achieved during the period 1978-1983, the likely first achievements being the installation of a solar desalination system for potable water supply in 100 villages, the production of solar water-heaters for bio-

gas plants as a village handicraft, a 10 kW solar thermal power plant and 1 kW solar pumps.

Solar energy research efforts are being co-ordinated by the National Committee on Science and Technology. Funds are provided to research laboratories, universities, industrial associations and other voluntary organizations by the Department of Science and Technology, by government-supported research councils and by the Tata Energy Research Institute. For co-ordinated work, it may be desirable to have a single, over-all planning, funding and evaluating unit to cover the whole field of renewable energy or only that of solar energy. A single research institute for solar energy research would be useful if the current groups become constituent regional units for field-testing and centres of excellence in one specific field each.

## RECENT RESEARCH AND DEVELOPMENT ON SOLAR ENERGY APPLICATIONS IN JAPAN (NR/ERD/EWGSW/CR.4 and NR/ERD/EWGSW/CR.6)\*

by

Mr. T. Noguchi (Japan)

During the 10-year period ending in 1971, research and development in the solar energy field was related to agricultural applications, water-heating, space heating and cooling, small-scale power generation, solar furnaces and investigation of materials. Subsequent developments have been fairly fast because of the oil crisis, and the budget of the "Sunshine Project" (see document NR/ERD/EWGSW/CR.18) includes 874 million yen for research and development on solar energy. The work programme includes major investigations on thermal and photo-voltaic conversion, water-heating, space heating and cooling, solar furnaces and solar process heating.

During the earlier period, solar radiation measurements and their statistical correlation, assessment of turbidity coefficients, intensities on tilted surfaces, and studies of the relation between sunshine hours and solar radiation were carried out in considerable detail.

Work on agricultural applications of solar energy included: establishing the relationship between the quantity of ripening rice, sunshine hours and ambient temperature (critical air temperature is found to be about 22°C for ripening rice); warming cool irrigation water for paddy fields by means of a solar pond; lowering the temperature of water for paddy fields by dispersing carbon black or white plastic film or polystyrene flakes; study of an open-cycle algae pond; production of cattle feed; mulching in fruit orchards to prevent the growth of weeds; investigation of in-

expensive greenhouses with plastic films; snow melting by the use of calcium silicate and development of a solarimeter for the measurement of photosynthetically active radiation.

Solar water-heating is a large and growing industry in Japan, with some six companies manufacturing solar heaters of the closed-cycle type or natural-circulation type. For some 15 years, silicon-cell solar batteries have been used in large numbers for microwave relay stations, unattended navigation lighthouses, buoys, and robot rain gauges. Solar furnaces giving very high temperatures of the order of 3,000°C have mainly been concerned with temperature and emissivity measurements of metal oxides, freezing points of ceramic oxides, high-temperature phase diagram studies, for obtaining single crystals, and for studies on sintering of ferrite compacts. A feasibility study of the use of a large-scale solar furnace as a heat source for industry is under way.

Architectural glass materials (heat absorbing and reflecting glass, combined with aluminium-sputtered polyester film) are commercially available. Recently constructed solar houses in Japan use flat-plate collectors with selective surfaces of copper oxide on copper sheet, and black chrome on stainless steel sheet, and are operated with lithium bromide water absorption units for heating, cooling and hot water supply.

Energy demands in many of the developing countries have not been assessed, and comprehensive

\* Summarized.

surveys are essential to find the areas in which solar energy can play a part. It seems likely that there will be requirements for extensive applications of solar energy for salt production, water desalination, and crop drying, with possible requirements for food and timber processing, heating and cooling and thermal and photovoltaic conversion. Part of the research and development facilities in Japan will be devoted to these pro-

cesses in order to be able to assist the developing countries by transfer of technology.

Reliability criteria of solar devices, availability and cost problems require investigation under inter-regional co-operative research and development, and it is suggested that a world research and development institution for solar energy be set up as well as a local regional centre for training and education.

## SOLAR ENERGY IN AUSTRALIA (NR/ERD/EWGSW/CR.7)\*

by

Mr. R. V. Dunkle (Australia)

### A. RESEARCH AND DEVELOPMENT

Solar energy research in Australia was initiated nearly 30 years ago, mainly in the fields of low-grade thermal applications. Since 1973 there has been a sharp increase in interest in solar energy utilization. Current research and development covers the following fields: (a) preparation of radiation standards, and of solar tables and diagrams; (b) thermal performance and behaviour in dwellings and plastic greenhouses; (c) integrated system design for solar house-heating; (d) selective surfaces; (e) cost reduction in water heating through use of aluminium instead of copper; (f) drying kiln for timber; (g) energy plantation; (h) generating high temperatures (60° to 80°C) for the food-processing industry; (i) small power systems (up to 20 watts) for remote telecommunications; (j) swimming-pool heating; (k) air-conditioning; (l) use of reversible chemical reactions to transfer energy from solar radiation collection systems; (m) heat pipe studies; (n) linear concentrators; (o) photothermal conversion; and (p) solar-operated water pumps. Funds are mostly provided by the Australian Government either directly, or through statutory bodies, such as the Australian Research Grants Committee (which supports universities) and the Australian Industrial Research and Development Grants Board (research in industry).

#### (a) Commonwealth Scientific and Industrial Research Organization (CSIRO)

During the 1950s, pioneering work was carried out in the Division of Mechanical Engineering on a prototype solar water-heater (reference S 44) which led to the development of a solar water-heating industry in Australia. A simple solar still (reference S 45) was developed, but this did not reach the commercial stage. Other work included crop drying and solar ponds. In 1959, the Division expanded its programme to include the fields of thermal radiation and solar

energy research. Work was carried out on selective surfaces, solar distillation, solar air-conditioning, water-heaters and air-heaters.

The Division of Atmospheric Physics has tackled solar measurement problems and developed excellent calibration facilities for both solar and long-wave radiometers, and several new types of radiometers.

The Division of Irrigation Research has investigated solar measurements in connexion with their field-work in irrigation evaporation and plant growth, and developed a useful evaporated film thermopile and pyranometer (reference S 46).

#### (b) Australian universities

Australian universities have lagged somewhat behind CSIRO in commencing solar energy research, concentrating on basic rather than applied research. Most programmes were initiated in the 1960s, but there has been a recent sharp upsurge in activity.

*University of New South Wales.* Primary concern has been with solar measurements, and the use of silicon cells for this purpose.

*University of Queensland.* The most significant work has been in the area of solar air-conditioning, and this has involved development and testing of a solar air-conditioned dwelling using solar-heated water with a lithium bromide absorption system (reference S 47).

*University of Melbourne.* Primary concern has been with heat transfer mechanisms in solar systems, and this has included such problems as asymmetric duct heating (reference S 48), free convection in inclined cells, entrance effects in air-heaters, and the theoretical and experimental evaluation of the heat loss from flat-plate absorbers (reference S 49).

\* Abridged.

*Monash University.* The most relevant research has been fundamental work on heat and mass transfer, for example on heat transfer in asymmetrically heated triangular ducts (reference S 50). More recent studies on energy storage using desiccant beds (reference S 51) and problems of regenerator design for a system with coupled heat and mass transfer in porous beds (references S 52 and S 53) have also been directed towards understanding the performance of components of solar systems.

*University of Western Australia.* Although located in the centre of the greatest concentration of manufacturers of solar water-heaters, and in the area where solar energy is most competitive, the only significant work has been on a theoretical and experimental study of solar stills (references S 54 and S 55).

### (c) Industry

The solar water-heating field represents the only solar manufacturing industry of importance in Australia. Several manufacturers commenced production between 1955 and 1960, large firms already producing conventional hot-water systems and also small firms which have built up successful and growing businesses over the years. Although based on the original copper tube and plate CSIRO developments, significant innovation has taken place and many varied designs are on the market. Sales have been mainly within Australia and the islands to the north, but one company has recently licensed a Japanese manufacturer to produce hot-water systems based on the Australian design.

### (d) Department of Housing and Construction

An experimental solar system was installed late in 1956 in Coolgardie, Western Australia. The success of this installation, and economic analysis of solar relative to other water-heating systems, led to the decision that the installation of solar water-heating should be recommended in both homes and institutional buildings in the Northern Territory of Australia and most locations in Papua New Guinea. Users are generally satisfied with both the amount and temperature of hot water available; boosters are not normally called upon except where systems serve large families.

## B. INDUSTRIAL, COMMERCIAL AND DOMESTIC UTILIZATION

The current status of solar energy utilization in Australia for industrial, commercial and domestic purposes has been summarized in reference S 56.

Australian *per capita* consumption of energy is high by world standards, about 50 per cent of the total being supplied by petroleum products, with transportation becoming increasingly dependent on liquid fuels.

The percentage contribution of petroleum is expected to decrease significantly as indigenous oil reserves are limited, while the use of natural gas (which is present in some abundance) should increase very rapidly. Coal reserves are very large, and coal provides the primary energy for about 75 per cent of the country's electric power production, the remainder being hydroelectricity.

The major contribution of solar energy in industry currently is in salt production. In 1972/73, the total salt production in Australia was 3,774,000 tons, essentially all produced by solar evaporation of sea water. The energy input required to evaporate the water to produce this much salt amounts to about 12 per cent of the total annual Australian energy consumption. This large amount of energy is neglected by government statisticians as it is not bought, sold or metered. Similarly, agricultural solar energy used does not appear in any energy input tabulation.

Solar water-heating is growing rapidly in Australia, although the total energy supplied is negligibly small in terms of the total energy consumed in Australia. The majority of the installations are in private homes, but a significant number supply hot water to schools, hospitals, motels and hostels.

The total solar water-heater area installed in Australia can be approximated by summing the annual production figures since 1969, which total 58,000 m<sup>2</sup>. Although some of the water-heaters have been exported, this estimate is likely to be somewhat low as the production figures before 1969 are not available. Moreover, many collectors have been home made and there is no way to estimate their area. However, this figure can be used to approximate the solar energy used for water-heating in Australia at about 0.0047 per cent of the total energy consumption. Although this present contribution is negligible, it could become important if current growth rates continue.

Another, and even more rapidly increasing use, is in swimming-pool heating. Largely as a result of the increasing affluence and leisure time in Australia, home swimming pools are becoming very common. Because of the low temperature needed, 20° to 27°C, the solar heaters can be very simple and yet highly efficient, and a great many home made solar swimming-pool heaters are being installed. No figures are available, but it is likely that this application will soon exceed other solar water-heating in terms of solar energy utilized.

## C. FUTURE TRENDS

A very large amount of low-grade thermal energy is used by industry at temperatures below 120°C (reference S 56). This is a promising area for solar energy utilization in the future.

A significant and rapidly growing use of energy in Australia is for the heating and air-conditioning of homes. This is an area wherein a viable solar-energy industry can develop similar to the water-heating industry. Both solar space heating and air-conditioning can be achieved (references S 47, S 57, S 58, S 59, S 60), but the economic question is unresolved. With

good engineering design, solar space heating should become important in Australia, but economical solar air-conditioning could prove to be a more difficult problem. It is likely that most installations, at least initially, will be on new dwellings specifically designed for solar heating.

### SOLAR ENERGY IN SOUTHEAST ASIA (NR/ERD/EWGSW/CR.8)\*

by

Mr. R. H. B. Exell, Asian Institute of Technology

As Thailand occupies a central position in the southeast Asian peninsula, the solar energy data of this country can be extended, with some amount of approximation, to other neighbouring countries of the region. Although a network of solar radiation stations is necessary for a comprehensive assessment of the available solar intensity in a country or a region, it is possible to calculate approximately, with the help of the Angstrom regression equation, the intensity of solar radiation from data on the duration of sunshine. This relationship has been used to calculate the solar data for a number of areas in Thailand from the radiation data obtained in Bangkok and Chiang Mai, where the average values of global solar radiation are from 450 to 350 cal/cm<sup>2</sup>/day. Nevertheless, it is desirable to set up at least a few measurement stations in Thailand for making accurate and detailed measurements of solar radiation on a continuing basis, following the pattern of standards set up by the World Meteorological Organization.

Inexpensive devices for solar data measurement, such as simple portable solar water-heaters of standard design can be used to obtain data in individual locations and rural areas with reasonable accuracy. Survey and analysis of such data for the region would be of great assistance in choosing sites for solar installations and in the design of suitable collecting systems.

In the Asian Institute of Technology, there are four ongoing research projects of relevance to the region:

(a) Solar-power water pump to be used for low-lift irrigation, with a lift of about 3 m. With average solar radiation of 400 cal/cm<sup>2</sup>/day, and an estimated

over-all efficiency of 5 per cent (2 per cent at present), a collector area of 3.5 m<sup>2</sup> per hectare will be required for 100 m<sup>3</sup> of water per day.

(b) Solar ice-maker to be used for cold storage of food and for ice making. An intermittent ammonia/water system with a collector area of 2 m<sup>2</sup> is being used to obtain preliminary data and practical experience; the future prototype design will be for 100 kg of ice per day.

(c) Solar stills for producing potable water for rural areas. Several solar stills of wooden construction have been experimented with. One unit, equipped with external mirror attachments, is capable of producing 3.2 litres of fresh water per square metre per day. Another of the units, of concrete design with a glass surface area of 3.5 m<sup>2</sup>, has a stirring device (powered by a windmill) to facilitate investigation of the effects of seeding the feed water with varying dosages of carbon particles. There is also provision for rainwater collection on some units.

(d) Solar drying units for drying agricultural and marine products. At present, one unit, with a moving bed and a total glass surface area of 7 m<sup>2</sup> is under study for residence time, drier configuration, mass feed rate, etc.

ESCAP is well suited to give a lead to the countries of the region in the promotion of utilization of solar energy. The establishment of an information and service centre at ESCAP is suggested, to act as a clearing-house for dissemination of information on solar energy publications and projects, to organize short courses, workshops and conferences, and to assist in arranging finance for the various countries of the region.

\* Summarized.

## SOLAR ENERGY AND ENERGY CONSERVATION IN AUSTRALIAN BUILDINGS (NR/ERD/EGWSW/CR.9)\*

by

Mr. N. R. Sheridan (Australia)

### A. A DISTINCTIVE AUSTRALIAN DESIGN OF COLLECTOR

The Australian domestic water-heater has evolved from an original design of the Commonwealth Scientific and Industrial Research Organization (CSIRO). With a single pass through several parallel tubes, the absorber plate has changed little with development. It is usually fabricated from copper tube and sheet by soft and/or hard soldering. Specialized materials, such as "tube-in-strip" and "roll-bond", have been used, but the market is hardly large enough for the production investment of these special materials. Besides, both these materials have corrosion problems resulting from carbon inclusions in copper tube-in-strip and pinholing of aluminium roll-bond.

Originally, black-painted absorbing surface was used with two glass covers. However, the copper oxide selective surface, produced by chemical treatment, has been simple to produce in the small plants, is reliable in service and achieves with only one glass cover a similar performance to the original design. It is usually used. The radiation properties of the selective surface are absorptance 0.89 and emittance 0.17 and are stable up to a temperature of 150°C, which is about the equilibrium temperature for the collectors when dry.

Simplicity has been a basic design criterion, so the systems generally have thermosyphon circulation of the potable water at low pressure. The resulting advantages include no circulation pump, a minimum of controls, no heat exchanger, and no risk of contamination of potable water with heat transfer fluid. Against this must be weighed the disadvantages of the tank location, which must be above the collectors and high enough to supply pressure to the water outlets.

### B. ENERGY NEEDS OF AN AUSTRALIAN RESIDENCE

The Australian people are concentrated on the coastal fringe between Brisbane in the north and Adelaide, with Melbourne being the most southerly major city. In this area, about 10 per cent of the Australian land surface, live 90 per cent of the population. The climate is mild throughout. Only a small amount of heating is required, and there is little real need for summer air-conditioning.

An analysis of energy use per household shows a considerable difference between two cities at the extremes of the well-populated region, though this difference is due mainly to the heating load. Low-grade energy defined as heat energy up to a maximum temperature of 120°C, is a large part of the energy demand, 2,400 kWh (49 per cent) in Queensland, and 10,000 kWh (67 per cent) in Victoria.

Energy costs for Australian residences have not risen dramatically in the last decade as the proportion of energy supplied by high-cost petroleum is relatively small. Natural gas has not been available until recently, so that electricity, which is mainly generated from coal, has obtained a major share of the load. Electrical energy is sold on an incremental cost basis at off-peak hours for domestic hot water and thermal energy stores, which are used in space heating. The discount from regular prices is 25 to 40 per cent. Control of off-peak power is by time clock or audio-frequency switching with a signal superimposed on the power circuit.

### C. ENERGY CONSERVATION IN BUILDINGS

Energy conservation in buildings has many aspects, including the use of solar energy. The various systems may be classified as follows:

#### (a) Non-solar

- (i) Thermal conductance: insulation, percentage glass
- (ii) Thermal capacitance
- (iii) Layout: area of outside wall per unit floor area, zoning
- (iv) Infiltration: heat exchange between ventilation and exhaust air
- (v) Heat pump, total energy, etc.
- (vi) Evaporative cooling: roof sprays, roof pool, natural wind coolers, forced ventilation coolers
- (vii) Operational techniques on air-conditioning and water systems
- (viii) Performance of equipment

#### (b) Passive solar

- (i) Orientation: sun control
- (ii) Aspect ratio

\*Abridged, and including "Solar energy as a natural resource" (NR/ERD/EGWSW/CR.12).

- (iii) Thermal conductance: variable conductance, roof pool
  - (iv) Thermal reflectance: wall surface, glass
  - (v) Radiant transmittance: variable transmittance, south wall collector
  - (vi) Shading: parasol roof, roof overhang, louvres
  - (vii) Wind: attic ventilators, Altenkirch dehumidification system
- (c) *Active solar*
- (i) No-utility energy: electricity generation, heating and cooling.
  - (ii) Low-utility energy:
    - a. Domestic hot water
    - b. Swimming-pool heating
    - c. Space heating: forced air, hydronic
    - d. Space cooling: nocturnal radiation, absorption refrigeration, Rankine refrigeration, ejector refrigeration, open-cycle systems
  - (iii) Unlimited utility energy: solar heat pump

#### D. AUSTRALIAN CONTRIBUTIONS TO ENERGY CONSERVATION

##### 1. Tropical house design

In the underdeveloped tropical north of Australia, refrigerated air-conditioning for residences can be justified on currently accepted comfort standards, but it costs more than the inhabitants can afford. Cost factors include: the high number of cooling degree days, the high cost of electricity generated in relatively small diesel plants, the inadequate buildings for retrofitting of equipment, and the high cost of maintenance in a remote area. One study showed that the cost of air-conditioning a residence was as much as 20 per cent of the family income.

In the past, the houses have been built of light-weight, uninsulated construction on stilts, high stumps which allow the underneath section to be used for laundry, storage, garage, etc. Shading, reflection, orientation and other energy-saving ideas have not generally been considered. It has been shown that, since the ground temperature at 1 m depth is always below the comfort temperature, a concrete slab on the ground acts as a heat sink. Coupled with an insulated envelope and masonry partitions to increase the thermal capacitance, a slab will considerably reduce day-time temperatures. Such houses would also be satisfactory

for future air-conditioning. Proposed standards for thermal performance for Australian government houses are given in reference S 61.

##### 2. Heat pump

The heat pump cycle has been used in window air-conditioners for many years, and has been used in the air-conditioning of several large buildings. In the mild Australian climate, the outdoor coil has little trouble with icing, especially if arranged for solar assistance. There have been problems with the compressors under the higher temperature of operation, but they will be overcome as equipment designed for the purpose becomes more readily available.

##### 3. Evaporative processes

Evaporative cooling should be applicable to energy conservation, as it is capable of providing space cooling with much less energy than refrigerated systems. Such systems need to achieve a room air change every one or two minutes to utilize the small available temperature drop between supply air and room temperature. The resulting relatively high air quantities must be delivered by properly sized registers to insure good distribution and satisfactory noise levels. Further, to achieve a saturation efficiency of 80 per cent as is desirable, the evaporative system must be carefully designed.

Several compound or staged cycles can be developed, which improve the cooling capabilities of evaporative processes, or extend their usefulness to areas of higher wet-bulb temperatures. These cycles make use of heat exchangers and dehumidification devices in addition to the evaporative cooler.

The aim of much CSIRO research has been to improve the efficiency or effectiveness of the components. A target of 80 per cent for saturation efficiency of evaporative coolers, effectiveness of heat exchangers and effectiveness of dehumidifiers seems reasonable.

(a) *Use of rock piles.* The rock pile, a reasonably inexpensive heat exchanger and heat storage device, can be used in several ways as a component of evaporative systems.

As a long-term storage device, it can be cooled down over-night by evaporatively cooled air. In the day-time, outside air can be drawn through the pile to pre-cool it. Subsequently, it can be evaporatively cooled for supply to the room.

CSIRO has developed a rockbed regenerative cooler which consists of a rockbed heat exchanger and a rockbed evaporative cooling matrix, each in two parts. These are used alternatively: one being cooled



by evaporation, while the other is cooling the supply air. The heat exchanger consists of two beds, each 4.5 m<sup>2</sup> in area and 127 mm thick. The rocks are 6 mm screenings which are treated with bitumastic material to restrict the absorption of moisture. Associated with each heat exchanger bed is an evaporating matrix of area 3.9 m<sup>2</sup> and 38 mm thickness. Untreated 6 mm screenings are used for the matrix. A motor-driven damper reverses the direction through the heat exchangers every five minutes, and the evaporating bed is sprayed for 12 seconds every second cycle. In appropriately insulated buildings, the systems produce satisfactory conditions, with an air change every 2 minutes in areas where the design wet-bulb temperature at the 2.5 per cent level is 24°C or less. With limited batch production, the units cost about 20 per cent more than equivalent refrigerated units, but the energy cost is about half.

(b) *Dehumidification cycles.* The basic dehumidification cycle uses an adsorbent or absorbent chemical to dry the air at constant enthalpy. Subsequently, it can be cooled to approach the dry-bulb or wet-bulb temperatures and then evaporatively cooled. The chemical can be regenerated by solar-heated air. Lithium chloride solution is a suitable absorbent, while adsorbent cycles use silica gel or alumina (reference S 57).

#### 4. Roof pool

The thermal capacitance and the evaporative effects are two properties of water that can be exploited in the roof pool. For heating, the pool can be covered by a transparent cover, and acts like a solar collector which stores its energy in the water. Circulation through a slab floor further enhances the storage. For cooling, the pool should be covered with an opaque material in the day-time and uncovered at night to lower its temperature by radiation and evaporative cooling. A research project is being undertaken and preliminary results are encouraging.

#### 5. Isolated homestead

In Australia, there are perhaps 50,000 residences which are so far from electrical supply lines that it is uneconomical to supply them. Thus, it appears that a solar generating plant could be a desirable alternative. It would be convenient if the device could supply *heating and cooling as well as electricity.* A study has commenced at the University of Queensland on the possibility of meeting the required load from a concentrating collector using photovoltaic cells. Water for cooling the cells would supply the heating and/or cooling loads. As the concentration ratio is 40:1, the cost of the cells should be reasonable. However, it is probable that gallium arsenide or some similar high temperature cell will be needed.

#### 6. Domestic hot water

Research of interest to domestic water-heaters is continuing at several establishments. Materials research aims at improving selective surfaces as regards their optical performance, their corrosion resistance and their ability to be applied to different materials. There is also the problem of corrosion on the heat-transport fluid side of the plate. Much effort is being expended on a chromium oxide coating for mild steel, a product that is in commercial use as a corrosion-protection coating. The aim is to improve its selective properties.

For small, forced-circulation systems, only a few watts of pump power are needed and would seem to be within the capability of photovoltaic cells. CSIRO has developed a small centrifugal pump driven by a solar battery. The system has the advantage that it is self-controlling, the pump starting to operate when solar energy is available, and has a mass flow rate related to intensity of insolation. The cost is comparable with the combined cost of available pumps and controllers.

Plane reflectors can improve the output of flat-plate collectors. Provided they are simple to install, they may be cost-effective. Their use has been investigated for Brisbane at latitude 27.5°S. It has been shown that vertical specular reflectors mounted behind the absorber plate and with three times its area will increase winter output about 15 per cent.

#### 7. Swimming-pool heating

A study showed that the desirable features for the collector were: an area as large as the pool area, an inclination equal to the latitude plus 15°, an operating collector temperature only 3°C above pool temperature, and a simple, cheap construction. The experimental collector was made from black-painted corrugated aluminium roofing with the water running down the corrugations. A three-month extension to the swimming season was obtained (reference S 62).

Plastic pool-covers made from ultra-violet stabilized, clear PVC film are sold commercially. They need to be custom-made to ensure a good fit and to reduce convection losses.

#### 8. Space heating

Very few solar space heating systems have been applied to buildings in Australia. CSIRO reports the use of a solar heater with an area of 56 m<sup>2</sup> on a building in Melbourne in association with a rock pile of 32 m<sup>3</sup>. When the outlet air temperature from the collector is controlled to 55°C, an average daily efficiency of 30 per cent is claimed (reference S 63).

### 9. Space cooling

A solar air-conditioned house was operated in Brisbane for several years (reference S 64). The system used a lithium bromide water absorption refrigerator supplied with water at temperatures up to 95°C from a flat-plate solar collector. Water storage was provided for the hot water and a rock pile was used in the conditioned air circuit. The system was shown to be technically feasible.

#### E. POTENTIAL FOR SOLAR ENERGY DEVELOPMENT IN SOUTHEAST ASIA

The changing pattern of the world energy resource base must inevitably affect countries in the region. The developing countries have a relatively low *per capita* energy usage, but this will increase with industrial growth. Commercial energy production is not as centralized as in more developed countries, leading to relatively high per unit cost, which has encouraged conservatism in utilization. The arguments for energy independence are equally applicable as in any other part of the world, and the advantages of having diverse sources of energy also apply, while the developmental options might not be restricted by previous major commitments.

There is a need to consider alternative sources of energy, especially those that are locally available, and solar energy is attractive, particularly in tropical areas

where the solar radiation is relatively uniform on a seasonal basis, subject to some reduction due to clouds and the water-vapour content of the atmosphere during heavy rainfall periods.

In any country, the contribution of solar energy is unlikely to exceed 6 to 8 per cent of total energy by the end of the century, and most of this will come from high technology devices which still require considerable developmental work. Considering the high risk and long-term aspects of research and development of such devices, and the capital intensive nature of the likely products, it is doubtful if such work is warranted in the developing countries.

Solar domestic hot water is a possible application of social significance, but of limited benefit as a means of reducing non-renewable fuel consumption; there is little need for further basic research in this field. Low-energy devices for "comfort conditioning" are suitable for widespread application; considerable local research, development and demonstration would be needed to achieve any reasonable level of market penetration.

The limited funds available locally for solar energy and related research and development would probably be best channelled into those projects which can be introduced in the short term. Domestic hot water and low-energy comfort conditioning are two candidate systems.

## RESEARCH, DEVELOPMENT AND USE OF SOLAR ENERGY IN THAILAND (NR/ERD/EWGSW/CR.10)\*

by

The National Energy Administration (Thailand)

Owing to the increasing demand for energy and the rise in the price of oil, solar energy is now considered as an important alternative source of energy in the country. Some solar radiation data for Bangkok and Chiang Mai are available (average values 410 and 432 cal/cm<sup>2</sup>/day respectively) from meteorological stations. Data for other areas, particularly rural areas, would be necessary for a realistic assessment of the possible uses of solar energy, and a network of solar radiation measuring stations has been planned by the National Energy Administration which is responsible for the over-all planning of energy. A comprehensive survey is planned, followed by analysis, and it is expected that substantial use will be made of this abundant non-polluting source of energy.

\* Summarized.

Solar energy is already in use in the country in a fairly primitive way for drying foodstuffs and industrial raw materials, and for common salt production. The King Mongkut Institute of Technology has recently carried out some investigations on small-scale solar water-heating and steam-generation; flat-plate collectors (1.2 m<sup>2</sup>) of aluminium and copper have been used. The Asian Institute of Technology is carrying out investigations on solar distillation, drying of crops, water pumping, and refrigeration.

As investigation on solar energy is at an early stage in Thailand, technical assistance will be useful for the development of solar devices for urban and rural areas; particularly for cooling of houses and large buildings, heating of water and air, and small power generation.

**PROGRAMME AND PROGRESS FOR SOLAR HOUSE DEVELOPMENT IN KOREA  
(NR/ERD/EWGSW/CR.11)\***

*by*

Mr. Jong Hee Cha (Republic of Korea)

With increasing demand for commercial forms of energy, and the rise in the price of oil, the planners considered possible uses of alternative sources of energy, such as solar energy and wind energy. From a brief survey of heat insulation practices in the country, and the available materials for building construction, it was possible to visualize effective use being made of solar energy for space heating of residences and large buildings. More comprehensive surveys of a similar nature will be needed before the status of solar energy in the spectrum of sources of energy can be firmly established.

The plan of action for development of a solar house includes an exhaustive survey of geographic climatology, experiments with solar collectors using both water and air as the heated medium, studies of

available construction materials, consideration of maintenance problems, the design of a prototype house, investigation of a suitable solar heating system for large buildings, economic evaluation of solar heating of houses and large buildings and collaboration with industrial firms for design and manufacture of heating systems.

The results of initial experiments in the prototype solar house indicate that solar energy can meet about 85 per cent of the heat load, the rest being met by the auxiliary heating system. In the cost structure of the solar heating system, the investment cost of the solar collector accounts for about 75 per cent of the total, with a cost of \$US 46 per m<sup>2</sup>. In order to obtain optimum technical and economic benefits from the heating system, further developmental investigations are planned, particularly on the selectivity of the heat-collecting surfaces.

\* Summarized.

**THE PROSPECTS OF SOLAR ENERGY UTILIZATION: THE INDONESIAN CASE  
(NR/ERD/EWGSW/CR.14)\***

*by*

Mr. F. Harahap (Indonesia)

Indonesia is characterized by archipelago conditions, dispersed and sometimes inaccessible population, abundant labour and limitations on capital, and is faced with high investments for conventional power stations and electrical transmission.

There is great concern in the country at the substantial use of non-commercial forms of energy, particularly wood, and commercial energy (mainly oil products) accounts for only about one third of total energy consumption. On the other hand, the sale price of oil available for export is high, and it is not desired to increase local usage of oil products. At the same time, energy requirements are increasing, especially in the rural areas.

Solar energy is an abundant resource, and may be able to meet a significant part of the energy requirements. The Center for Meteorology and Geophysics measures solar radiation only at its main stations at Jakarta, Bandung, Medan and Kupang. Based on

measurements at these four stations, the estimated solar radiation data is about 402 cal/cm<sup>2</sup>/day. For the total area of the country of 1.9 million square km, the total incident solar radiation is the equivalent of  $3.2 \times 10^{15}$  kWh per year, which is 42,000 times the rate of energy consumption in the country in 1972.

The possible uses of solar energy under consideration relate to:

- (a) Space heating and cooling, water-heating, food preservation and solar pumping;
- (b) The drying of agricultural products;
- (c) Biochemical conversion in methane gas plants to produce fuel for cooking and/or lighting.

At present, the ongoing research and development projects in the country are the development of a solar rice-drier, a bio-gas-powered ice-machine, and a water-heater at the Institute of Technology, Bandung, and investigation of direct conversion of solar energy at the National Institute of Physics and Electronics.

\* Summarized.

**THE SUNSHINE PROJECT: SOLAR ENERGY RESEARCH AND DEVELOPMENT  
(NR/ERD/EWGSW/CR.18)\***

*by*

The Agency of Industrial Science and  
Technology (Japan)

The Sunshine Project was announced by the Government of Japan in 1973 and commenced in July 1974. It covers research and development for several energy sources, with an initial budget of 2,200 million yen, of which 874 million yen is set aside for solar

energy. The total budget, for work up to the year 2000, is estimated to be 430,000 million yen.

The solar energy programme includes major investigations on several devices and processes. Initial activity has been directed towards space heating and procedures by which this can be applied to existing houses and larger buildings.

\* Summarized.

**SOLAR ENERGY WORK IN PAKISTAN (NR/ERD/EWGSW/CR.19)\***

*by*

Mr. M. M. Anwar (Pakistan)

*Introduction*

Pakistan must import coal and oil as sources of heat and power, which is mainly consumed by industry and in urban areas. The rural population, which comprises more than 80 per cent of the total, meets its heat energy needs from cattle dung, farm wastes and wood; the power requirements are met by human and animal muscular energy. In the province of Punjab, 40,000 villages lack electricity. In a span of three years, about 1,000 villages have been electrified. Electric power has become a basic need, bringing new life and education to villages.

Looking to new sources of cheap energy, those which offer promise are nuclear energy, wind energy and solar energy.

In Pakistan, research and development on various problems of solar energy was first taken up by a few scientists at the Atomic Energy Centre at Lahore in 1964. The success of "solar-lights" in remote villages aroused much interest.

Solar energy work in Pakistan has been carried out at the Atomic Energy Centre (Lahore), the Sea-water Desalination Project (Gwadar), and the Engineering and Technology Universities of Lahore and Peshawar. A brief account of the fields and progress of the work follows below.

**A. WORK DONE AT A.E.C., LAHORE**

**(a) Solar-lights for rural areas**

In experiments on new lighting systems, silicon solar cells were used with nickel-cadmium storage

batteries. After a number of trials, a system of solar-cell lighting with a small panel of 5 watt rating was developed (references S 65, S 66). The system provides lighting, and can also be used for operating transistor radios at all hours. Sixteen solar lighting kits were installed in various regions of Pakistan. Their performance over a period of 10 to 11 years has been encouraging. One house was supplied with a television set which operated for three years. Another has been operating for the last five years (reference S 67).

**(b) Fabrication of silicon solar cells**

During 1970-1972, a small laboratory was set up to develop solar-cell processes. Cut-wafers of silicon were used as starting material, yielding solar-cells of 8 per cent efficiency at a cost of \$US 30 per watt. It was estimated that the choice of silicon rods as starting material would bring the cost down to about \$ 20 per watt.

**(c) Solar water-pump**

A solar water-pump was designed (reference S 68) which utilized an 8-m diameter paraboloid fitted with flat mirrors, a boiler and a steam engine. The complete system was made with locally available material, and it provided 1.5 kW to the water-pump. In order to study smaller portable units, 1.5-m diameter mosaic mirrors were constructed and connected to a steam engine and boiler.

**(d) Solar water-chillers**

The purpose of this project was to produce chilled water by solar energy. A rectangular paraboloid mounted with flat mirrors was used to concentrate the

\* Abridged.

solar radiation on a water/ammonia container of an absorption machine (reference S 69). The system produced 22 litres of cold water (5°C). Later models used flat-plate absorbers of the water-heater type.

(e) *Solar water-heaters*

In December 1969, three solar water-heaters were installed on the roof to supply hot water in the wash-rooms (reference S 70). One model was supplemented with an electric element to keep the water hot (at 40° to 45°C) on cloudy days. The other models supplied water at 60° to 70°C to be mixed with cold water. The efficiency of the solar water-heaters was 80 per cent, and the cost of the model with a 1 m<sup>2</sup> face was \$US 20. Several large and small models were fabricated, including some which supplied steam.

(f) *Family-size water stills*

In numerous areas of Pakistan there is a shortage of water for human and animal consumption. Solar stills were developed, 5 m x 1 m, to supply about 15 litres of water per day for a small family (reference S 71). The demand for such stills is very large, and the laboratory cannot meet it. Development of pre-fabricated stills would be most desirable.

(g) *Solar driers*

The customary technique of open drying exposes the products to dust and contamination, and the drying process takes several days. A well-designed solar drier cuts the period of drying and results in high-quality products. Solar driers (reference S 72) were fabricated from locally available material, with a tray size 2.5 m x 0.6 m, costing \$US 10.

## B. DESALINATION PLANT AT GWADAR

Gwadar lies about 300 miles west of Karachi along the Arabian seacoast and has a population of 20,000. For this remote but important fishing village, the Government approved a scheme for the construction

of a solar desalination plant with a capacity of 70 m<sup>3</sup> per day. The plant (reference S 73) has 250 still units, each 20 m long with a rectangular frame structure of aluminium alloy, and a reinforced concrete supporting structure. The plant currently supplies 36 to 45 m<sup>3</sup> of water per day at a cost of \$US 0.3 to 0.5 per m<sup>3</sup>. Previously, the cost of fresh water brought from Karachi was \$US 10 per m<sup>3</sup>.

## C. WORK IN THE UNIVERSITIES

The Engineering and Technology Universities at Lahore and Peshawar have been taking a great interest in harnessing solar energy by giving problems in this field to students for thesis material. The problems that have been tackled are: a portable, 1.5-m mosaic paraboloid mirror as concentrator; a 2 m mirror for use with a boiler and turbine; a solar ice-machine and water-chiller; a solar-operated model aeroplane; a solar-operated flat-plate thermoelectric generator; and solar cookers and water-heaters.

## D. FUTURE WORK

Considering the above review of solar energy research and development, it should be possible to start a programme in solar energy on a more organized basis. Instead of scattered attempts and duplication of work, it would be desirable to establish an exclusive institute of solar energy in Pakistan.

A roving seminar should be held in Pakistan in order to arouse the interest of large sections of the Government and the public, teachers and students. Universities and research institutes in Karachi, Sind, Lahore, Peshawar and Islamabad could serve as hosts to the seminar.

Funds should be allocated to building working models, thereby enabling engineers and industrialists to acquire a first-hand knowledge of how a solar energy device looks, its size, portability, and construction material.

### III. CONSOLIDATED LIST OF REFERENCES ON SOLAR ENERGY

- S 1. J. A. Duffie, C. Smith and G. O. G. Löf, *Bulletin 21* (Engineering Experimental Station, Wisconsin University, 1964).
- S 2. N. Robinson, *Solar Radiation* (Elsevier, 1967).
- S 3. H. Tabor, *Report of the UNESCO Working Party on Solar Energy* (Paris, 1973).
- S 4. S. Akymil and K. Selcuk, *Solar Energy*, 14, 3/3, 1973.
- S 5. United Nations Conference on New Sources of Energy, Rome, 1961; report in two volumes.
- S 6. Atomic Energy Research Establishment (Harwell) Report, R. 6775, 1971.
- S 7. *Solar Use Now — A Resource for People*, Solar Energy Congress, Los Angeles, 1975.
- S 8. *Proceedings of the International Conference on Solar Energy*, Maryland, 1971.
- S 9. H. P. Garg and C. L. Gupta, "Design of flat-plate solar collectors for India", *Journal of Institution of Engineers (India)*, XLVIII (9), MES, 1967.
- S 10. H. P. Garg and A. Krishnan, "Solar energy utilization potential in India," *Sun in the Service of Mankind*, International Solar Energy Society, Congress paper E12, Paris, 1973.
- S 11. C. L. Gupta, "Field design methods and data for solar energy applications", *Sun in the Service of Mankind*, International Solar Energy Society, Congress paper E45, Paris, 1973.
- S 12. V. G. Bhide, *Report of the National Committee for Science and Technology Expert Panel on Solar Energy* (New Delhi, Government of India, Department of Science and Technology, 1974).
- S 13. S. Rangarajan and V. Desikan, "A review of solar radiation measurements in India", preprint for 7th National Solar Energy Convention, Punjab Agricultural University, Ludhiana, 1975.
- S 14. R. K. Bhardwaj, "Solar drying in food-processing industry", IVth meeting of the Solar Energy Working Group, Roorkee, 1972.
- S 15. H. P. Garg and A. Krishnan, "Solar drying of agricultural products, Pt. I: Drying of chillies in a solar cabinet dryer", *Annals of Arid Zone*, 13(4), 1974.
- S 16. V. R. Muthuveerappan and others, "Design of solar paddy dryer", VIth meeting of the Solar Energy Working Group, Allahabad, 1974.
- S 17. B. Kempe-Gowde, "Grain drying by solar heated air", VIIth meeting of the Solar Energy Working Group, Ludhiana, 1975.
- S 18. R. Lawlor, "Algae research in India", *Alternative Sources of Energy*, No. 16, 1974.
- S 19. A. K. Bhatia and S. L. Gupta, "Drying of apricots in Ladakh by solar energy", VIIth meeting of the Solar Energy Working Group, Ludhiana, 1975.
- S 20. C. L. Gupta and H. P. Garg, "Performance studies on solar air-heaters", *Solar Energy*, II (1), 1967.
- S 21. C. L. Gupta, "Action plan for solar drying", ACES occasional report No. 5, 1973.
- S 22. S. N. Sharma and others, "A solar timber kiln", *Journal of Timber Development Association of India*, 17(2), 1972.
- S 23. H. P. Garg and H. S. Mann, "Effect of climate, operational and design parameters on the year-round performance of single-slope and double-slope solar stills under India arid-zone conditions", International Solar Energy Society Conference, Los Angeles, 1975.
- S 24. R. L. Datta, "Solar energy utilization in developing countries", Appendix B in *Solar Energy in Developing Countries: Perspectives and Prospects* (Washington, D.C., National Academy of Sciences, 1972).
- S 25. R. L. Datta and others, "Evaporation of sea-water in solar stills and its development for desalination", *Proceedings of First Institute Symposium on Water Desalination*, Washington, D.C., 1967.
- S 26. C. L. Gupta, "A baseline concept for solar power generation in India", *Proceedings of the National Seminar on Energy Conservation*, Paper N-1, Madras, 1975.

- S 27. H. C. Agarwal and B. S. Sandhu, "Feasibility of running a large-scale power plant using water lenses", VIIth meeting of the Solar Energy Working Group, Ludhiana, 1975.
- S 28. Raju Kanaka, and others, "20 kW solar dynamic power system — a feasibility study", VIIth meeting of the Solar Energy Working Group, Ludhiana, 1975.
- S 29. K. N. Mathur and M. L. Khanna, "Some observations on a domestic solar water-heater", *Proceedings of the UNESCO Symposium on Wind and Solar Energy*, New Delhi, 1956, pp. 202 ff; also United Nations Conference on New Sources of Energy, Rome, 1961.
- S 30. C. L. Gupta and H. P. Garg, "System design in solar water-heaters with natural circulation", *Solar Energy*, 12, 1968.
- S 31. C. L. Gupta and others, "Solar-cum-electric water-heater", *Indian and Eastern Engineer*, III (1), 1969.
- S 32. A. Pandya, "Experience with solar energy utilization", IVth meeting of the Solar Energy Working Group, Roorkee, 1972.
- S 33. T. A. Reddy and C. L. Gupta, "*Solar Water-heater, Design and Cost Optimization Studies*", higher course project report (Pondicherry, Sri Aurobindo International Centre of Education, 1975).
- S 34. H. P. Garg and others, "Design and performance prediction of a built-in, low-cost solar water-heater", *Research and Industry*, 17, 1972.
- S 35. J. P. Gupta and others, "Solar space-heating at high altitudes", IIIrd meeting of the Solar Energy Working Group, Kanpur, 1971.
- S 36. V. Charan and others, "Development of a room air-conditioner using solar energy", Vth meeting of the Solar Energy Working Group, Madras, 1973.
- S 37. S. C. Mullick and M. C. Gupta, "Solar desorption of absorbent solutions for air-conditioning", *Solar Energy*, 16, 1974, pp. 19-24.
- S 38. C. L. Gupta, "A thermal design model for a natural air-conditioning system", *Proceedings, International Solar Energy Society Conference*, Los Angeles, 1975.
- S 39. P. Chandra and others, "Performance of rock-pile storage in cooling of buildings", VIIth meeting of the Solar Energy Working Group, Ludhiana, 1975.
- S 40. R. L. Datta, "Solar energy; its relevance to India", *Invention Intelligence*, 9, 1974.
- S 41. V. G. Bhide, "Solar energy utilization in India and abroad", *Proceedings, Seminar on Industrial Applications of Solar Energy*, Madras, 1975.
- S 42. S. C. Mullick and C. L. Gupta, private communication.
- S 43. K. D. Mannan and L. S. Cheema, "High-temperature water-heater using a new stationary concentrator", VIIth meeting of the Solar Energy Working Group, Ludhiana, 1975.
- S 44. R. N. Morse, "Solar water-heaters", *Proceedings, World Symposium on Applied Solar Energy*, Phoenix, Arizona, 1955.
- S 45. B. W. Wilson, "Solar distillation in Australia", *Trans. Conference on the Use of Solar Energy*, Tucson, Arizona, 1955; 3: *Thermal Processes*, II, 1958.
- S 46. D. J. Norris and E. S. Trickett, "A simple, low-cost pyranometer", *Solar Energy*, 12(2), 1968.
- S 47. N. R. Sheridan, "On solar operation of absorption air-conditioners", Ph.D. thesis, University of Queensland, 1968.
- S 48. H. M. Tan and W. W. S. Charters, "Effect of thermal entrance region on turbulent, forced convective heat transfer for an asymmetrically heated rectangular duct with uniform heat flux", *Solar Energy*, 12(4), 1969.
- S 49. A. D. Rankine and W. W. S. Charters, "Combined convective and radiative heat losses from flat-plate solar air-heaters", *Solar Energy*, 12(4), 1969.
- S 50. P. C. Bandopadhyay, J. B. Hinwood and C. W. Ambrose, "Turbulent heat transfer in isosceles triangular ducts of small apex angle", First Australasian Conference on Heat and Mass Transfer, Monash University, Melbourne, 1973.
- S 51. D. J. Close and R. V. Dunkle, "Energy storage using desiccant beds", paper No. 7/24, International Solar Energy Society Conference, Melbourne, 1970.
- S 52. R. V. Dunkle and I. L. MacLaine-Cross, "Theory and design of rotary regenerators for air-conditioning", *Mech. Chem. Engng. Trans., Instn. Engrs. Aust.*, 6(1), 1970.

- S 53. I. L. McClaine-Cross and P. J. Banks, "Coupled heat and mass transfer in regenerators: prediction using an analogy with heat transfer", *Int. J. Heat Mass Transfer*, 15(6), 1972.
- S 54. P. I. Cooper, "Digital simulation of transient solar still processes", *Solar Energy*, 12(3), 1969.
- S 55. P. I. Cooper, "The absorption of radiation in solar stills", *Solar Energy*, 12(3), 1969.
- S 56. R. N. Morse, P. I. Cooper and D. Proctor, "The status of solar energy utilization in Australia for industrial, commercial and domestic purposes", report No. 74/1, *CSIRO Solar Energy Studies*, 1974.
- S 57. R. V. Dunkle, "A method of solar air-conditioning", *Mech. Chem. Engng. Trans., Instn. Engrs. Aust.*, 1(1), 1965.
- S 58. D. J. Close, R. V. Dunkle and K. A. Robeson, "Design and performance of a thermal storage air-conditioning system", *Mech. Chem. Engng. Trans., Instn. Engrs. Aust.*, 4(1), 1968.
- S 59. D. J. Close, "Solar air-heaters for low and moderate-temperature applications", *Solar Energy*, 7(3), 1963.
- S 60. R. V. Dunkle, "Design considerations and performance predictions for an integrated solar air-heater and gravelbed thermal store in a dwelling", International Solar Energy Society, ANZ Section, Symposium on Applications of Solar Energy Research and Development in Australia, Melbourne, 1975.
- S 61. F. Wickham, "Programs of the Australian Department of Housing and Construction", *Proceedings*, United States-Australia Joint Seminar, Durham, N. C., 1975.
- S 62. N. R. Sheridan, *The Heating of Swimming Pools*, Solar Research Notes No. 4, (Brisbane, University of Queensland, 1972).
- S 63. D. J. Close and others, "Design and performance of a thermal storage air-conditioning system", *Mech. Chem. Engng. Trans., Instn. Engrs. Aust.*, 4(1), 1968.
- S 64. N. R. Sheridan, "Performance of the Brisbane solar house", *Solar Energy Journal*, vol. 13, 1972.
- S 65. M. M. Anwar, "Rural electrification utilizing Si-solar cells", *PAEC/Elect-8* (Lahore, Atomic Energy Centre, 1966).
- S 66. M. M. Anwar, "Role of silicon solar cells for providing lights in rural areas of Pakistan", paper No. 2/28, International Solar Energy Society Conference, Melbourne, 1970.
- S 67. M. M. Anwar, "Silicon solar-cell generator for operating transistorized television", *PAEC/Sol-5* (Lahore, Atomic Energy Centre, 1973).
- S 68. M. M. Anwar, "Final technical report on development of solar-powered equipment for operating a small irrigation water pump", *PAEC/Sol-3* (Lahore, Atomic Energy Centre, 1967).
- S 69. A. L. Taseer and others, "Solar water-chiller", *PAEC/Elect-25*, (Lahore, Atomic Energy Centre, 1971).
- S 70. G. Nabi, "A technical report on the performance of solar water-heater", *PAEC/Elect-27* (Lahore, Atomic Energy Centre, 1972).
- S 71. M. Saif-ur-Rehman and others, "A technical report on the family size solar still", *PAEC/Desal-1* (Lahore, Atomic Energy Centre, 1971).
- S 72. A. M. Cheems, "Solar dryer for agricultural products", *PAEC/Sol-29* (Lahore, Atomic Energy Centre, 1972).
- S 73. M. Saif-ur-Rehman, "Solar desalination, performance, comparison and cost analysis of concrete-base and wooden-base solar stills", *PAEC/Desal-2* (Lahore, Atomic Energy Centre, 1972).
- Other useful references*
- The Sun in the Service of Mankind*, Proceedings of the UNESCO-International Solar Energy Congress, (Paris, UNESCO, 1973).
- G. O. G. Löf, J. A. Duffie and C. O. Smith, *World Distribution of Solar Radiation*, (Solar Energy Laboratory, University of Wisconsin, 1966).
- F. Daniels, *Direct Use of the Sun's Energy*, (New Haven, Yale University Press, 1964).
- B. J. Brinkworth, *Solar Energy for Man*, (Compton Press, 1972).
- A. Zarem and D. Erway, *Introduction to the Utilization of Solar Energy*, (McGraw-Hill, 1973).



*Solar Energy in Developing Countries: Perspectives and Prospects*, (Washington, D. C., National Academy of Sciences, 1972).

S. G. Talbert, J. A. Eibling and G. O. G. Löf, *Manual of Solar Distillation* (Columbus, Ohio; Battelle Memorial Institute, 1971).

*Solar Distillation* (United Nations Publication, Sales No. E.70.II.B.1).

J. A. Duffie and W. A. Beckman, *Solar Energy Thermal Processes*, (Wiley International, 1972).

*Proceedings of International Conference on Photovoltaic Power Generation*, Hamburg, 1974 (UNESCO).

#### *Periodicals*

*Solar Energy*, International Solar Energy Society, Pergam Press, Oxford, UK.

*Solar Energy Digest*, Solar Energy Digest, San Diego, California, USA.

*Heliotechnology*, Russian language periodical translated by USA Department of Commerce, National Technical Information Service, USA.

*Comples*, Co-opération Méditerranéenne Pour l'Énergie Solaire, Service De La Complex, Marseille, France.

*Synergy Access*, 21st Century Media, New York, USA.

## IV. ORGANIZATIONS CONCERNED WITH SOLAR ENERGY

### (Preliminary List)

<i>Organization</i>	<i>Officer concerned</i>	<i>Fields of work</i>
<i>A. Research Centres in the ESCAP Region</i>		
<i>1. Australia</i>		
Directorate of Solar Energy Studies, Melbourne Commonwealth Scientific and Industrial Research Organization (CSIRO)	R. N. Morse	Co-ordination of solar energy studies in Australia
Mechanical Engineering Division, P.O. Box 26, Highett, Victoria 3190	R. V. Dunkle	Solar collectors, selective surfaces, water heating, space heating, storage, solar stills, timber kilns
Division of Atmospheric Physics, P.O. Box 77, Mordialloc, Victoria 3195	B. G. Collins	Radiation standards
Division of Building Research, P.O. Box 56, Highett, Victoria 3190	E. R. Ballantyne	Solar tables, thermal performance of dwellings
Division of Mineral Chemistry, P.O. Box 124, Port Melbourne, Victoria 3207	A. F. Reid	Selective surfaces
Division of Irrigation Research, Private Bag, Griffith, N.S.W. 2680	K. V. Gartoli	Plastic greenhouses
Division of Plant Industry, P.O. Box 1600, Canberra City, A.C.T. 2601	R. M. Gifford	Plant conversion
Postmaster-General's Department, Building Branch, 140 Bourke Street, Melbourne, Victoria 3000	A. L. Holderness	Small power systems
Australian National University, Department of Engineering Physics, P.O. Box 4, Canberra, A.C.T. 2600	P. O. Cardew	Reversible chemical reactions
University of Melbourne, Parkville, Victoria 3052	W. W. S. Charters	Air heaters, heat pipes, heat pump, mirror, boiler, honeycomb, grain drying
University of Sydney, Energy Research Centre, Sydney, N.S.W. 2006	D. R. McKenzie	Selective surfaces, photo-thermal conversion, plant conversion
University of New South Wales, P.O. Box 1, Kensington, N.S.W. 2033		
School of Engineering	L. W. Davies	Photo-voltaic conversion
School of Mechanical Engineering	C. M. Sapsford	Air heaters, water-heaters, radiation
School of Physics	L. B. Harris	Refrigeration, hydrogen production, thermo-electric generation, photo-lysis, linear concentrators, concentrators for industry
N.S.W. Institute of Technology, School of Physics and Materials, P.O. Box 123, Broadway, N.S.W. 2007	T. M. Sabine	High-temperature absorber, cadmium sulphide cells
University of Queensland, Department of Mechanical Engineering, St. Lucia, Queensland 4067	M. K. Peck	Thermo-electric module, climatic control, building heating and cooling
James Cook University of North Queensland, Department of Engineering, P.O. James Cook University, Queensland 4811	D. J. Close	Air heating, cooling, storage, timber drying
Capricornia Institute of Advanced Education, M.S. 76, Rockhampton, Queensland 4700	J. W. Bugler	Insolation
University of Adelaide, Mechanical Engineering Department, Adelaide, South Australia 5001	R. E. Luxton	Computer-based building thermal energy system
University of Western Australia, Department of Physical and Inorganic Chemistry, Nedlands, Western Australia, 6009	T. I. Quickenden	Photo-electro-chemical effects

<i>Organization</i>	<i>Officer concerned</i>	<i>Fields of work</i>
<b>2. India</b>		
Meteorological Department, New Delhi	A. Mani	Radiation, measurements
National Physical Laboratory, New Delhi	V. G. Bhide	Flat-plate medium-temperature collectors
Solid State Physics Laboratory, Delhi	I. C. Mathur	Silicone cell
Central Salt and Marine Chemicals Research Institute, Bhavnagar	R. L. Datta	Desalination
Defence Science Laboratory, Jodhpur	J. P. Gupta	Space heating
Central Building Research Institute, Roorkee	Dinesh Mohan	Water-heaters
University of Roorkee, Roorkee	C. P. Gupta	Air-conditioning
Sri Aurobindo Ashram, Pondicherry 2	C. L. Gupta	Mini-power plants
Indian Institute of Technology, Delhi	K. L. Chopra	Cells
Indian Institute of Technology, Madras	M. C. Gupta	Space heating and cooling
Indian Institute of Technology, Kanpur	H. C. Agarwal	Power, using water lenses
Annamalai University, Annamalai, Chidambaram	V. R. Muthuveerappan	Rice drying
Punjab Agricultural University, Ludhiana	K. D. Mannan	Stationary concentrators for power
Central Arid Zone Research Institute, Jodhpur	H. P. Garg	Agricultural uses
Forest Research Institute, Dehradun	S. N. Sharma	Timber kiln
Khadi and Village Industries, Allahabad	A. Pandya	Slurry heater
Regional Engineering College, Ahmedabad	B. K. Gupta	Large fresnel lenses
Birla Institute of Technology and Science, Pilani	D. P. Rao	Pump
Bangalore Agricultural University, Bangalore, Karnataka	B. Kempe-Govde	Drying
Indian Institute of Science, Bangalore, Karnataka, 560012	K. Prasad	Small engines
Jadavpur University, Calcutta	S. Deb	Cadmium sulphide cells
Space Technology Centre, Trivandrum	M. R. Mukherji	Cells
Bhabha Atomic Research Centre, Trombay	M. R. Srinivasan	Concentration of wastes by heating
Tata Institute of Fundamental Research, Bombay	G. Swarup	Ray tracing in dish-type concentrators
<b>3. Indonesia</b>		
Bandung Institute of Technology	F. Harahap	Refrigeration, water heating, grain drying
National Institute of Physics and Electronics	F. Harahap	Direct conversion
<b>4. Japan</b>		
Government Industrial Research Institute, Solar Research Laboratory, 1 Hirati-Machi, Kita-Ku, Nagoya	T. Noguchi	High-temperature furnace, heating and cooling, power production
Waseda University, Department of Architecture, Tokyo	K. Kimura	Heating, cooling, solar house
Osaka Institute of Technology, 5-16-1 Omiya, Asahi-ku, Osaka 535	Y. Saito	Collectors
Osaka University, Faculty of Engineering Science, Toyonaka, Tokyo	H. Tsubomura	Cells
Kagakin University, 1-24 Nishi-shinjuku, Shinjuku, Tokyo	Y. Nakajima	Storage tanks
Electrotechnical Laboratory, Tanashi, Tokyo	S. Sawata	Selective surfaces, thermal power
<b>5. Malaysia</b>		
University of Malaysia, Engineering Faculty, Kuala Lumpur 22-11	K. S. Ong	Water-heater
<b>6. Nepal</b>		
Balaju Yantra Shala, Plumbing Division, Kathmandu	Rajesh Prasad	Water-heater

<i>Organization</i>	<i>Officer concerned</i>	<i>Fields of work</i>
7. <i>New Zealand</i> Department of Scientific and Industrial Research, Physics and Engineering Laboratory, Private Bag, Lower Hutt	R. F. Benseman	Water-heaters
8. <i>Papua New Guinea</i> Papua New Guinea University of Technology, Department of Mechanical Engineering, P.O. Box 793, Lae	J. C. V. Chinappa	Pump, refrigerator
9. <i>Pakistan</i> Atomic Energy Research Centre, Lahore	M. M. Anwar	Lighting, cells, pump, heating, cooling, drier, solar still
Sea Water Desalination Project, Gwadar	M. Saif-ur-Rehman	Desalination
Engineering and Technology University, Lahore	—	Various student projects
Engineering and Technology University, Peshawar	—	Various student projects
10. <i>Philippines</i> National Science Development Board, Bicutau, Taguig, Rizal	V. Jose	Water heating
University of the Philippines, Quezon City	L. Abis	Desalination
De La Salle University, Manila	Martinez	Engine for agro-industrial purposes
Project Santa Barbara, Sangley Point, Cavite City	E. Terrado	Refrigeration
11. <i>Republic of Korea</i> Korea Atomic Energy Research Institute, Thermal-Hydraulics Laboratory, P.O. Box 7, Cheong Ryang, Seoul	J. H. Cha	Flat-plate collectors
Korea Advanced Institute of Science, P.O. Box 150, Cheong-Ryang-Ri, Seoul	S. Bae	Solar house
12. <i>Thailand</i> Asian Institute of Technology, P.O. Box 2754, Bangkok	P. A. Cowell	Pump, ice-maker, grain driers, solar stills
The King Mongkut Institute of Technology, Department of Mechanical Engineering, Thonburi	C. Rithipuk	Water-heater, steam generation
B. <i>Other Organizations</i>		
1. <i>Argentina</i> Division Heliogergetica, Commission Nacional de Estudios Geo-heliofisicos, Av. Mitre 3100 San Miguel, Pcia de Buenos Aires	J. L. Gnerrero	Solar devices
2. <i>Belgium</i> Section of Radiometrie, Institut Royal Météorologique de Belgique, 3 Avenue Circulaire, 1180 Bruxelles	R. Dogniaux	Research
3. <i>Brazil</i> Fisica ESALQ, Caixa Postal 9, 13400 Piracicaba SP	J. C. Ometto	Solar devices
4. <i>Bulgaria</i> Ecole Supérieure de Sylviculture, Sofia	R. J. Florov	Solar devices
5. <i>Canada</i> Brace Research Institute, MacDonald College of McGill University, P.O. B 900, Stc. Anne de Bellevue 800, Quebec H9X 3M1	T. A. Lawand	All solar technologies
University of Waterloo, Waterloo, Ontario	K. G. T. Hollands	Solar devices
Faculty of Engineering Science, University of Western Ontario, London, Ontario N6A 5B9	R. K. Swartman	Refrigeration
Department of Chemistry, University of Western Ontario, London, Ontario N6A 5B7	J. R. Bolton	Solar devices

	<i>Organization</i>	<i>Officer concerned</i>	<i>Fields of work</i>
6.	<i>Chile</i> Solar Energy Laboratory, University of Tecnica, Casilla 110 V, Federico Santareira, Valparaiso	J. R. Hirsman	Solar devices
7.	<i>Czechoslovakia</i> Department of Building Physics, Slovak Technical University, Bratislava	—	Solar devices
	Institute of Experimental Endocrinology, Slovak Academy of Science, Bratislava	M. Fatranska	Solar devices
	Institute of Botany, Department of Hydrobotany, Czechoslovak Academy of Science, 37982 Trebon	D. Dykyjova	Solar devices
8.	<i>Denmark</i> Thermal Insulation Laboratory, Technical University of Denmark, Building 118, DK-2800 Lyngby	T. V. Esebensen	Solar devices
9.	<i>Egypt</i> Solar Energy Laboratory, National Research Centre, Sh.El-Tahrir, Dokki, Cairo	I. A. Sakr	Solar devices
10.	<i>Federal Republic of Germany</i> University of Eye Clinic, Munster	F. Hollwich	Solar devices
11.	<i>France</i> Solar Energy Laboratory, Centre National de la Recherche Scientifique, 66, Odello	F. Trombe	Solar devices
	Laboratoire de Magnétisme et de Physique du Solide du CNRS, Bellevue	M. Rodot	Solar devices
	Laboratoire des Ultra-Réfractaires, Centre National de la Recherche Scientifique, b.p. 5, 66120 Odello-Fontromeu	M. Foex	Solar devices
	Laboratoire de La Roquette, 34, St. Bauzille de Putois	R. D. Fox	Solar devices
	Association Française Pour l'Étude et la Développement de l'Énergie Solaire (AFEDES), 28 Rue de la Source, Paris	I. Peyches	All solar technologies
	Laboratoire d'Héliophysique, Université de Provence, 13-Marseille	G. Peri	Solar devices
	Université de Paris VI, Géophysique Spatiale — Option Environnement, 2 Place Jussieu, 75005 Paris	M. Cabanat	Solar devices
	Centre Université, d'Études Spatiales	M. P. Vasseur	Solar devices
	Station de Sylviculture et de Production, Centre National de Recherches Forestières, INRA, Nancy	M. Ducrey	Solar devices
	La Station de Physiologie de la Reproduction, INRA, 37389 Nouzilly	R. Ortavant	Solar devices
	Office Français de Recherches de Bioclimatologie and Société Météorologique de France, 196 rue de l'Université, 75007 Paris	—	Solar devices
	Station de Bioclimatologie, INRA, 84 Montfavet	J. Damagnez	Solar devices
	Observatoire Leon Teisserenc de Bort, 78190 Trappes	J. L. Plazy	Solar devices
	INRA, Route de Saint-Cry, 78000 Versailles	P. Chartier	Solar devices
12.	<i>French West Indies</i> INRA Bioclimatologie, 97170 Petit-Bourg, Guadeloupe	R. Bonhomme	Solar devices
13.	<i>Greece</i> Institut des Études Avancés Sur Les Énergies Solaire et Eolienne, Athens	A. Spanides	Solar devices
	University of Athens, P.O. Box 1199, Omonia, Athens	A. A. Delyannis	Solar devices
	National Technical University, Athens	N. G. Koumoutsos	Solar devices
	Solar Energy Research Centre, N.R.C. Democritos, Athens	A. Spyridonos	Solar devices



<i>Organization</i>	<i>Officer concerned</i>	<i>Fields of work</i>
23. <i>United States of America</i>		
Energy Research and Development Administration, Division of Solar Energy, 1800 6th Street, Washington, D.C. 20545	L. O. Herwig	Solar devices
NASA Goddard Code 322, Goddard Space Flight Center, Greenbelt, Maryland 20771	M. P. Thekackara	Solar devices
Lewis Research Center, NASA, 21000 Brookpark Road, Cleveland, Ohio 44135	H. B. Curtis	Solar devices
Thermal Engineering Section, Center for Building Technology, National Bur. of Standards, Washington, D.C. 20234	E. R. Streed	Solar devices
Fermi National Accelerator Laboratory, Batavia, Illinois 60510	H. Hintenberger	Solar devices
Smithsonian Radiation Biology Laboratory, 12441 Parklawn Drive, Rockville, Maryland 20852	W. H. Klein	Solar devices
Mid West Research Institute, Kansas City, Missouri	M. C. Noland	Solar devices
Solar Energy Systems Division 5717, Sandia Laboratories, Albuquerque, New Mexico 87115	R. W. Harringan	Solar devices
Franklin Institute, Philadelphia, Pennsylvania 19101	—	Solar devices
Solar Energy Applications Laboratory, Colorado State University, Fort Collins, Colorado 80523	G. O. G. Löf	Solar devices
Solar Energy Laboratory, University of Wisconsin, Madison, Wisconsin 53706	J. A. Duffie	Solar devices
Solar Energy and Energy Conversion Laboratories, University of Florida, Gainesville, Florida 32611	E. A. Farber	Solar devices
Environmental Research Laboratory, University of Arizona, Tucson Air Port, Tucson, Arizona 85706	C. N. Hodges	Solar devices
Optical Science Center, University of Arizona, Tucson, Arizona 85706	A. Meinel	Solar devices
Department of Mechanical Engineering, University of Maryland, College Park, Maryland 20742	F. H. Morse	Solar devices
Mechanical Engineering Department, College of Engineering Science and College of Architecture, Arizona State University, Tempe, Arizona 85281	J. I. Yellot	Solar devices
Department of Materials Science and Engineering, Hearst Mining Building, University of California, Berkeley, California 94720	M. F. Merriam	Solar devices
Department of Animal Physiology and the Institute of Ecology, University of California, Davies, California 95616	R. G. Schwab	Solar devices
Institute of Energy Conversion, University of Delaware, Newark, Delaware 19711	K. W. Boer	Solar devices
Energy and Kinetics Department, University of California, Los Angeles, California 90024	D. K. Edwards	Solar devices
Department of Mechanical Engineering, Bradley University, Peoria, Illinois 61625	Y. B. Safdari	Solar devices
Department of Mechanical Engineering, University of Minnesota, Minneapolis, Minnesota	E. R. G. Eckert	Solar devices
School of Mechanical Engineering, Georgia Institute of Technology, Atlanta, Georgia 30332	G. M. Kaplan	Solar devices
City College, University of New York, New York, N.Y. 10031	H. Lustig	Solar devices
Laboratory of Atmospheric Physics, Desert Research Institute, University of Nevada System, Reno, Nevada 89507	V. N. Smiley	Solar devices

<i>Organization</i>	<i>Officer concerned</i>	<i>Fields of work</i>
23. <i>United States of America (continued)</i>		
National Center for Energy, Management and Power, University of Pennsylvania, Philadelphia, Pennsylvania 19174	N. Lior	Solar devices
Texas A and M University, College Station, Texas	R. R. Davidson	Solar devices
Department of Agricultural Engineering, Purdue University, West Lafayette, Indiana 47907	R. M. Peart	Solar devices
Solar Energy Laboratory, University of Houston, Houston, Texas 77004	A. F. Hildebrandt	Solar devices
Massachusetts Institute of Technology, Department of Civil Engineering, Cambridge, Massachusetts	H. C. Hottel	Solar devices
Massachusetts Institute of Technology, Lincoln Laboratory, Lexington, Massachusetts 02173	P. O. Jarvinen	Solar devices
Institute for Energy Conversion, University of Pennsylvania, Philadelphia, Pennsylvania	M. Wolf	Solar devices
24. <i>West Indies</i>		
Department of Mechanical Engineering, University of the West Indies, St. Augustine, Trinidad	S. Satcunathan	Solar devices
25. <i>Yugoslavia</i>		
Department of Plant Physiology, University of Novi Sad, Akademska Street 2	M. R. Saric	Solar devices
26. <i>Zambia</i>		
Department of Civil Engineering, University of Zambia, Lusaka	J. M. K. Dake	Solar devices



**Part Three**

**DOCUMENTATION ON WIND ENERGY**

## I. WORKING PAPERS PRESENTED BY THE SECRETARIAT

### DEVELOPMENT OF WIND ENERGY UTILIZATION IN ASIA AND THE PACIFIC (NR/ERD/EWGSW/3)\*

#### INTRODUCTION

About 10,000,000 MW is continuously available in the earth's winds, and attempts have been made from time to time to use some of this power. It is mentioned in reference W 1 that the Babylonian ruler Hammurabi planned to use wind pumps for large-scale irrigation in the seventeenth century B. C. The raising of water by contrivances worked by wind power is mentioned in a Hindu classic (reference W 2) dated 400 B. C. By the fourth century A. D., windmills were widely used in Persia, and applications spread widely through the Moslem civilization and into China. From 1,100 A. D. onwards, wind energy utilization developed in Europe and, by the nineteenth century, was a significant source of industrial power, especially in the Netherlands.

Approximately 80 per cent of the population of the developing countries of the ESCAP region is engaged in agricultural production in rural areas, and uses mainly non-commercial sources of energy, such as human and animal muscle power, firewood and charcoal, cow dung and agricultural waste, and, to a limited extent, wind energy and solar energy (see reference W 3).

In any evaluation of energy utilization patterns in rural areas, it is noted that wind and solar energy have

\*Prepared by Mr. M. M. Sherman, consultant on wind energy, at the request of the ESCAP secretariat. The views expressed in this paper are the author's own and do not necessarily reflect those of the secretariat or the United Nations.

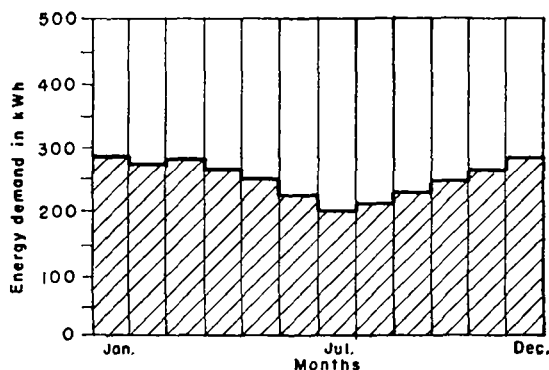

Figure 1. Monthly energy demand for electric lighting (50 families)

several important characteristics that make them well adapted to rural utilization: they are renewable sources; they are widely distributed and do not require a distribution network; they are under the direct control of the user; and their development and use can be based largely on local resources.

#### I. POTENTIAL INCREASE IN ENERGY UTILIZATION

##### A. LOCAL ENERGY NEEDS

Assuming that an increase in energy utilization is desirable in a particular rural area where transmitted electricity or energy based on oil products is not freely available, the first requirement is to quantify the present supplies and uses of energy and then to determine the additional uses and the minimum increase in energy required. Demand data should preferably be arranged in a form similar to the hypothetical examples of figure 1 and figure 2.

When the amount of increased energy supplies required has been determined, all available energy sources should be evaluated for their ability to satisfy the demand, proceeding in turn from increased efficiency in the use of currently-used sources to increased usage of locally available energy supplies, including biological fuels, solar energy and wind energy, before considering the use of transmitted electricity or oil products.

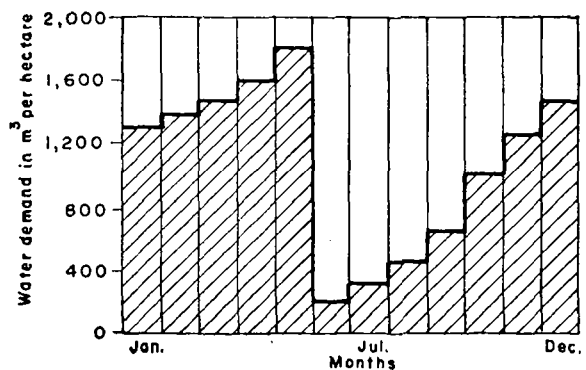

Figure 2. Monthly demand for irrigation pumping

## B. CALCULATION OF WIND ENERGY

The wind velocity is continually varying in both magnitude and direction, but is broadly predictable over significant periods of time, and the power in the windstream is proportional to the cube of the velocity. The equation for total available wind power is  $P = K A v^3$  where  $A$  is the cross-sectional area of the windstream and  $v$  is the velocity. The value of the constant  $K$  is 0.0000137 where the units used are kW,  $m^2$  and km/h. (See reference W 4).

Theoretically, 0.5926 per unit of the available wind power could be extracted by a wind rotor, but allowance must also be made for the practical efficiency of the rotor, transmission and power utilization device, which is normally in the range of 0.3 to 0.7 per unit. Expressing the over-all efficiency as  $E$ , the practical equation becomes:

$$P = 0.0000137 A v^3 \times 0.5926 E$$

## C. RELEVANT WIND MEASUREMENT INSTRUMENTS

Much valuable work has been done by the World Meteorological Organization on standardization of wind data collection for meteorological and navigational purposes. Preliminary efforts have been made at wind energy assessment (reference W 5), and it is hoped that further work will be carried out on standardization of instruments and methods of analysis of data for wind energy.

The most complete information on wind velocity behaviour is gained from anemometers giving continuous records of speed and direction. The Dines pressure tube anemograph is widely used as the standard wind-measuring device in many permanently established meteorological stations, but determination of average hourly wind velocities from the charts of this type of anemograph is difficult and time-consuming.

The electric cup-contact recording anemometer is extensively used for accurate determination of average hourly wind velocities. This device incorporates rotating cups which drive a device which makes a contact in an electric circuit once for some selected value of wind run, preferably 1 km. The circuit causes a pen to mark a continuous chart recorder, thus making it possible to determine the hourly run of the wind by counting the marks on each hourly segment of the chart. However, instruments of this kind are expensive to purchase and install and need skilled daily maintenance.

In a variant, a narrow paper tape is moved forward a short distance for each contact produced by the anemometer. A time switch is used to operate a pen or marker so that a mark is made on the tape at hourly intervals, and the distance between successive marks

represents the run of the wind. This type of instrument is designed particularly for economy and for simplicity in operation and chart interpretation.

An inexpensive method of wind recording used at some stations is a Robinson cup or propeller type of anemometer which is connected to a cyclometer type of digital indicator. The difference between any two readings indicates the run of the wind during the time interval, and hourly averages can be readily obtained.

Anemometers which give "instantaneous" wind speeds are used at many minor observation stations, including airports. These are indicating instruments, not recorders, and their readings are noted at certain specified times in the day, usually once per hour. The wind speed values thus measured are useful as a general guide, but do not give a good basis for an accurate statement of hourly average wind velocities.

There is a great need for a standardized, simple and inexpensive wind recording device specifically designed for the purpose of wind energy estimation. It has been reported (reference W 6) that a battery-powered energy sampling unit has recently been developed which counts the numbers of hours of duration of each wind velocity and also records solar energy intensity. This device is intended for use in remote locations and is expected to be commercially available in 1976.

## D. COLLECTION OF WIND VELOCITY DATA

It is highly desirable to determine accurately the total hourly duration of each wind velocity during each month of the year at the proposed windmill sites for a period of at least three years, in order to quantify the wind energy potential and to provide a basis for windmill selection and design. However, recording at the exact location and height of each proposed windmill is usually practicable only for the siting of large electric generating windmills.

When undertaking a comprehensive wind survey covering a large area with a similar weather pattern throughout, a reasonable procedure is to locate one continuous recording anemometer at a fully exposed primary site in conjunction with simple run of the wind unattended digital recording anemometers at several secondary locations where windmills are needed. Comparison of the average weekly or monthly wind velocity at the primary site and each secondary location will yield correlation factors which can be applied to the secondary site data to estimate the detailed wind characteristics. If data are available from a station which has a similar wind regime to a proposed site, a similar correlation procedure can be applied by making accurate hourly average measurements with a portable instrument at the proposed site for a fixed period and

comparing the results with the recording station hourly average measurements for the same period. Such a method has limitations, as the correlation factor may vary widely with different wind directions according to terrain differences between the primary site and the secondary recording station.

If adequate data are not available, an approximate assessment of wind patterns may be made by taking short-period observations of wind velocity with a portable instrument, in conjunction with individual discussions with several local inhabitants. Such discussions should seek to determine the relative windiness on a month-to-month basis (especially the months, with most and least wind), the periods and times of day when the wind is most and least and the direction and relative velocities of these winds, the maximum velocity during the year and the maximum length of time with no wind. This method is easy to undertake and may be the most appropriate for immediate widespread implementation of low-cost hand-crafted windmills.

#### E. ANALYSIS OF WIND VELOCITY DATA

Using the average monthly or annual wind velocity for determining the energy potential of a site may not give an accurate result, because some of the velocities included in the average may be above the rated wind velocity of a windmill and because  $(A + B + C)^3$  does not equal  $(A^3) + (B^3) + (C^3)$ .

A duration curve should be prepared as a graph of  $(v^3)$ , which is proportional to power, against time as shown in figure 3. It is also useful for determination of the optimum rated wind velocity of a windmill to plot a graph of wind velocity against time, as shown in figure 4.

For a particular wind pump at a particular location, the following basic data are required in order to predict the monthly and annual water output:

(a) Hourly average wind velocity records processed to become monthly and annual power duration curves of the type shown in figure 3;

(b) Water pumping rates of the wind pump under consideration within the range of minimum and maximum operating wind velocities when working against any fixed gross head, corrected for the actual gross head. These output rates may be depicted as in figure 5.

Multiplication of the number of hours duration per month at each wind velocity by the relevant hourly output rate will give a series of quantities which, when

summed, will yield the total monthly output. The result of calculations for each month of the year may then be shown as in figure 6. A comparison between figure 6 and figure 2 will indicate the seasonal correlations between water pumping demand and wind pumping capacity. It should be noted however that it may also be necessary to consider minimum outputs for shorter periods in order to assess storage requirements.

For estimates of wind-electric generator output, it is usual to assume that the total windmill efficiency is constant for all wind speeds. For a given tentative design, the wind velocity for starting, rated wind velocity and maximum allowable wind velocity are assumed, and figure 7 can be constructed from figure 3. Referring to figure 7, the shaded area (bcfgh) represents the actual output of energy, which will be some proportion of the rectangle (adeo) which represents the output if the windmill were running at full rated power throughout the period, the proportion being the load factor. Using data on a month-by-month basis, figure 8 may be constructed, indicating monthly production of wind energy.

## II. STATUS OF WINDMILLS FOR WATER PUMPING<sup>1</sup>

Priority consideration should be given to utilization of windmills for water pumping to supply the increasingly critical needs of domestic consumption, animal husbandry, agriculture and aquaculture.

Water pumping windmill systems can be broadly classified into three major categories: manually produced, mechanical drive; industrially produced, mechanical drive; and electric pumps powered by wind-generated electricity.

### A. MANUALLY PRODUCED, MECHANICAL DRIVE TYPES

Several different types of simple hand-crafted water pumping windmills have been developed and are now in seasonal use in various parts of the world. However, construction of each of these non-commercial types has tended to be localized because of communication barriers. These wind pumps have several common characteristics: they are constructed of locally available materials (often wood) and are produced with local skills, using simple hand tools; they may operate at low wind velocity; they require daily attendance when in operation; they require frequent but low-cost maintenance; and they are generally used for irrigation or drainage requiring relatively low lift.

<sup>1</sup> Illustrations of the basic types of windmills may be found in the second secretariat paper in this section.

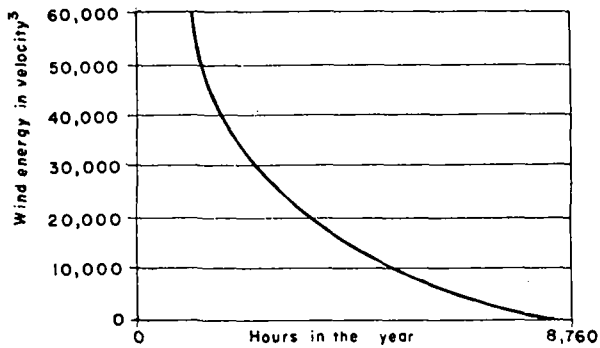

Figure 3. Power duration curve

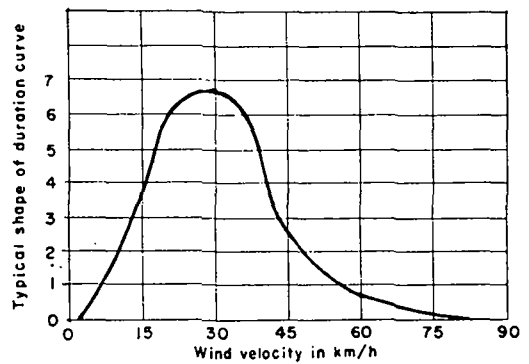

Figure 4. Velocity distribution (annual or monthly)

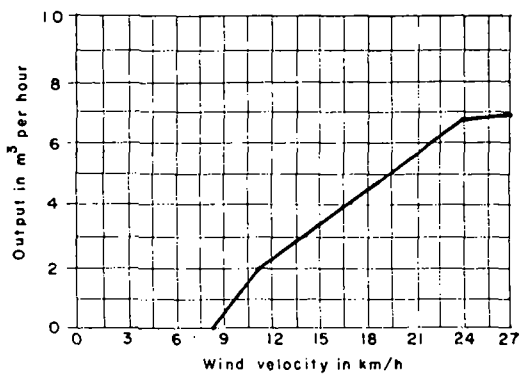

Figure 5. Wind pump performance

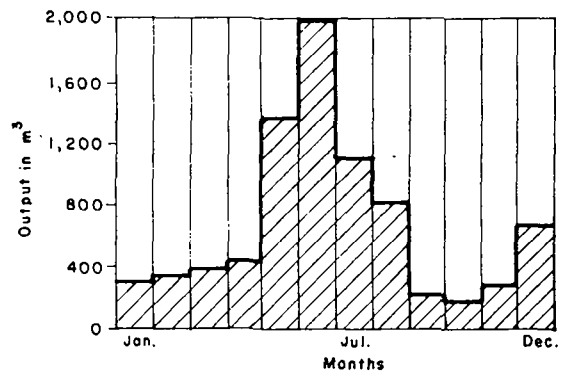

Figure 6. Monthly output of water per wind pump

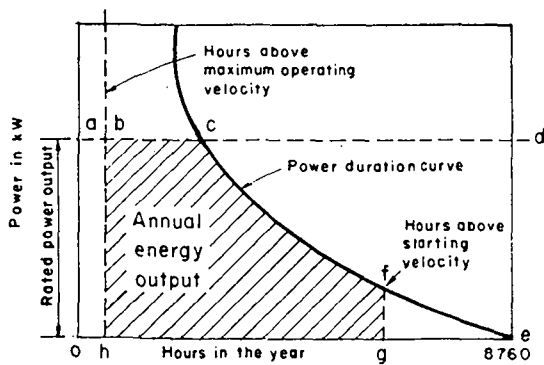

Figure 7. Estimate of energy output

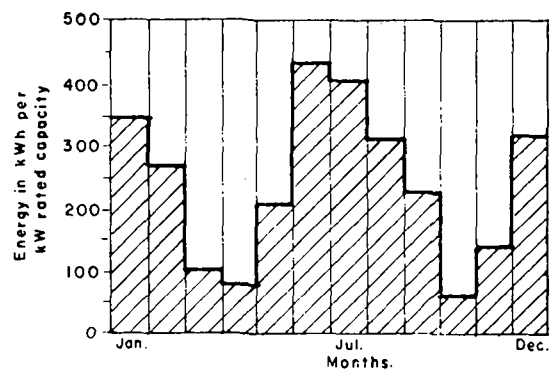

Figure 8. Monthly distribution of energy in the wind

## 1. The wind pumps of Lassithiou, Crete (Greece)

### (a) Usage

In the Mediterranean region, large stone tower mono-directional windmills with triangular cloth sails were historically used for grinding corn and pressing olive oil. Shortly before 1913 this traditional design was adapted in Crete to smaller lightweight structures for pumping water for seasonal irrigation of intensively cultivated plots of vegetables and grains. At least 6,000 of these devices are now in use in the broad fertile plain of Lassithiou which is isolated in the mountains, and some hundreds are also in use in other parts of Crete (see references W 7 and W 8).

### (b) Components

Viewed from a distance, all Cretan wind pumps look alike, but large variations in construction become apparent upon close examination. The components described here are generally accepted by the local farmers as being the most successful. The Lassithiou windmill design consists of 11 basic elements; sails, spars, hub, crankshaft, main bearings, tail, carriage, turntable, tower, storage tank and base-well.

*Sails* — A triangular cloth sail measuring 2.6 m x 1.2 m x 2.4 m is attached to each of the radial spars. The loose corner of each sail is secured by a rope to the tip of the adjacent spar, thus forming a strong uniform surface for catching the wind. The sails can be wrapped around the spars to control the amount of sail area exposed to the wind.

*Spars* — Commonly, eight wooden spars, each 2.7 m long, radiate out from the hub to form a total windmill diameter of 5.4 m. Stones are attached to the tips of some spars for balancing if required. An axial spar of angle iron extends 2 m out in front of the hub along the main axis of the crankshaft. Steel wires radiating back and out from the end of the axial spar to the tips of the radial spars provide bracing against strong winds, and steel wires between the tips of all the radial spars provide additional bracing. A 60-cm diameter flat steel ring around the hub is bolted to each spar to keep them secured tightly within the hub.

*Hub* — The front end of the crankshaft is inserted through a 30-cm diameter, 15-cm thick wooden hub with eight 5-cm square holes chiselled in the perimeter to receive the squared ends of the spars. The hub is fixed to the end of the shaft by a bolt passing through both. An improved hub made of two 30-cm diameter, 0.5-cm thick steel discs separated 5-cm apart by 16 small rectangles of 10-cm x 0.5-cm steel plate welded to form eight square holes has recently been adopted.

*Crankshaft* — The crankshaft is made of a 5-cm diameter, 160-cm long mild steel rod incorporating a U-shaped crank. The U-shape, which was formerly fashioned by bending, but more recently by welding, has an inside width of 7 cm and a height of 7.5 cm, giving a stroke of 15 cm. A 2-cm diameter steel connecting rod attached with two bolts to a wooden crank bearing transfers the rotary motion of the crankshaft into vertically reciprocating motion of the pump piston.

*Main bearings* — Two 34-cm wide, 15-cm high, 8-cm thick blocks of hardwood, each with a 5-cm diameter hole in the centre of the large surface, are bolted to the front and rear of the carriage to support the crankshaft.

*Tail* — A triangular tail of corrugated sheet steel 1.5 m x 1.5 m x 1 m is supported by two 2-m long pieces of angle iron from the rear of the carriage. (Some units have a manually-operated tail pole with no vane).

*Carriage* — The carriage is a rectangular angle iron frame 35-cm wide and 140-cm long, connected by four bolts to two 35-cm long pieces of angle iron riveted to a 45-cm diameter flat steel ring which rotates on the bottom inside surface of the turntable ring. This arrangement keeps the carriage firmly attached to the top of the tower, while, at the same time, allowing it and the attached shaft, sails, etc. to rotate when the wind direction changes.

*Turntable* — The turntable, riveted to the top of the four tower legs, is made of a 160-cm long piece of 5-cm mild steel angle iron bent into a 50-cm diameter ring to form a flat horizontal greased bearing surface for the carriage.

*Tower* — Normally the four-legged 5-m high tower is made from 5-cm mild steel angle iron, with flat steel riveted cross bracing, and is bolted and wired to the 1.5-m square base. (In some of the coastal villages several wind pumps are mounted on stone towers offset from the well.) Projecting stones or stepping holes in the tower give access to the sails and top mechanism.

*Storage tank* — A 13-cm diameter, 15-cm stroke piston pump, made from a discarded cannon shell and fitted with a leather foot valve and a leather-sealed piston, is mounted on the base in the centre of the tower.

*Base-well* — A 15-cm thick concrete slab covering a 2-m diameter, 7-m deep well forms the base of the windmill.

(c) *Construction materials and skills*

All the wooden bearings and spars are of local origin. The metal shaft and lengths of angle iron are fabricated using ordinary blacksmith's tools and skills. Recently, some electric welding has been utilized for construction of improved crankshafts and hubs.

(d) *Operation and maintenance*

To decrease sail area during periods of high wind, the operator wraps each cloth sail one or more times around its spar. During periods of very high winds, and when the operator is not in attendance, the sails are fully wrapped around the spars. The windmill can be stopped during operation by pulling the tail cord so that the surface of the sails is parallel to the wind. The sails are fully removed from the spars and stored during seasons when the wind pump is not required for irrigation. All bearings are greased twice a month. Sails and pump valves are normally replaced every two years. Spars and main bearings are replaced every five years.

(e) *Performance*

The Cretan windmills start pumping at a wind velocity of 8 km/h and reach optimum performance of 25 rev/min at 13 km/h. The wind pump will increase speed up to about 40 rev/min in higher winds before it controls itself through excessive tip drag and sail fluttering, although the sails are usually reefed at speeds above 25 rev/min. Lifting water as much as 5 m, this type of windmill pumps 3,000 litres per hour, 10-12 hours per day, 4-5 months per year, and has an expected lifetime of about 20 years.

(f) *Economics*

Each wind pumping system costs about \$US 480 (windmill \$US 320, storage tank \$US 120, pump \$US 40). The cost of water pumped is approximately one US cent per m<sup>3</sup>. The widespread success of the Cretan windmill design can be attributed to several factors, namely: the use of lightweight and inexpensive cloth as efficient aerofoils, the use of simple wooden bearings, availability of skilled local carpenters and blacksmiths for construction, large rotor diameter in relation to tower height, favourable local winds, high water-table, intensive agricultural production of cash crops and high cost of petroleum fuels and electricity.

In the 20-year period up to 1973, many of the original 10,000-12,000 windmills on Crete were retired owing to increased availability and low cost of oil products and electricity. Recently, however, many of the "retired" windmills have been put back in service.

2. *Adaptations of the Greek windmill configuration*(a) *United States of America*

A 7.6-m diameter sail windmill with six triangular sails of the classical Greek configuration has been designed by Windworks (reference W 9) and tested by the Brace Research Institute, Canada (see reference W 10). This adaptation incorporates durable sails of dacron polyester fibre, mounted on wooden spars. The rotor is mounted on a used automobile differential gear drive which transfers rotary motion with a speed increase ratio of 4:1. A vertical drive shaft delivers this rotary motion to the ground where it can be used for a variety of mechanical tasks, including water pumping. A unique steel octahedron truss tower design, with very high strength to weight ratio, is used. The complete unit costs about \$US 600 for materials plus 400 hours of skilled labour, and may be constructed by the owner.

(b) *India*

A 10-m diameter sail windmill with eight triangular cloth sails of the Greek configuration was constructed and tested by the Madurai Windmill Committee for irrigation pumping in low winds in southern India. This design utilizes a maximum of local materials and skills in an effort to keep the price within reach of common farmers. The eight sails, of khaki canvas, are fitted to bamboo spars which are clamped to a central hub adapted from an oxcart wheel. A steel crankshaft mounted in ball bearings transfers reciprocating motion, via a wooden connecting rod and a variable-stroke lever arm, to a 10-cm bore piston pump with a stroke of 30 cm. 6,000 litres of water per hour can be lifted 10 m at a rated wind velocity of 16 km/h. The welded steel turntable carriage, supporting the crankshaft and bamboo-mat tail, rests upon a turntable base made from a steel truck tyre rim which is bolted to the top of a tower made from six 8-m long teak poles. The total construction cost of this windmill was \$US 400. Construction plans are available from the TOOL Foundation (reference W 11).

Further design optimization and testing is currently in progress at the Agricultural Engineering Division of the Indian Agricultural Research Institute.

A 6-m diameter, six-sail adaptation of this wind pump has been constructed for second crop rice irrigation, and is currently undergoing trials with a 20-cm diameter piston pump at the Sarvodaya Educational Development Institute, Sri Lanka (see reference W 12).

(c) *Ethiopia*

The American Christian Mission at Omo, near Lake Rudolph, Ethiopia, has established a project called Food from Wind and is selling 6-blade Greek-type sail rotor wind pumps at a subsidized price to

local farmers for lifting river water for irrigation. In August 1975, 19 of these windmills were being operated by the local villagers and five more were being operated by the mission. This project, sponsored by the British charity organization OXFAM, intends to build a total of 100 wind pumps for use in the area. This adaptation may be utilized in areas where there is a shortage of wooden construction materials, and metal working facilities are available. A detailed report and drawings of the design are available from the Intermediate Technology Development Group, United Kingdom (see reference W 13).

### 3. Wind pumps of China

#### (a) *Luffing-sail type*

Simple hand-crafted windmills have been used in China for many centuries (see references W 14, W 15 and W 16). Reportedly the first of these were the hand-crafted luffing-sail vertical-axis wind pumps which are still extensively used along the eastern coast north of the Yangtze River, particularly near Tientsin, for lifting salt water into evaporating ponds. A minutely detailed study of these pumps has recently been made (reference W 17). The windmill has a central vertical wooden drive shaft from which radiate two sets of eight equally-spaced wooden poles, to give a total diameter of about 9 m. Eight vertical masts suspended between the tips of the 16 poles support eight 3 m x 1.8 m sails similar in construction and rigging to those on Chinese junks. When being pushed down-wind, each sail presents its full surface to the wind, being held in position by a rope. When returning against the wind, the sail turns automatically on the mast so that it presents only its edge, and no surface, to the wind. At the base of the vertical shaft, a 3-m diameter drive wheel with 88 wooden teeth engages a 15-tooth pinion gear mounted on one end of a horizontal shaft. At the other end of the horizontal shaft is a wheel with nine arms which drives the wooden chain of a square-pallet ladder pump. The whole unit is simple and inexpensive.

Further developments, including a more compact and economical arrangement, were shown at the Agricultural Machinery Exhibition at Peking in 1958.

Prototype construction of adaptations of this design has recently been undertaken in Thailand by the Division of Agricultural Engineering, Department of Agriculture.

#### (b) *Adaptation of Greek design*

In northeastern China, Greek-type windmills of wooden construction, with 12 cloth sails, are connected to paternoster pumps to lift irrigation water (reference W 18). These windmills use an eight-blade automatic fan tail for directional control, and each windmill is fitted with a simple wooden anemometer.

#### (c) *Oblique-axis type*

In some of the eastern provinces, especially between Shanghai and Hangchow, oblique-axis wind pumps similar to the Tjasker type (Netherlands) have been used for water lifting (reference W 19). These devices are fitted with six mat and batten type sails at the top end of the shaft, pointed into the wind. A steel wheel with 19 or 20 steel teeth, fitted to the bottom of the shaft, engages a similar toothed wheel fixed to the top of a vertical drive shaft supported by a short wooden four-legged tower. The vertical drive shaft is connected to a square-pallet ladder pump. The rotor can be pivoted around the vertical drive shaft to point into the wind by changing the position of the two wooden poles which form an A-frame supporting the top end of the shaft.

### 4. Hand-crafted wind pumps of Thailand

Several types of low-cost wind pumps are used in Thailand for pumping water for rice irrigation and salt production. These devices are explained in the paper presented by the National Energy Administration of Thailand. (See also reference W 20).

### 5. Wind pumps of the Netherlands

#### (a) *Hollow post type*

The *wipmolen* or hollow post type of wind pump (reference W 21) was developed in the fifteenth century and used extensively for drainage. It consists of four cloth-covered wooden lattice frames up to 10 m long, fixed to a wooden main shaft. The main shaft carries a large drive wheel with wooden teeth, driving a wooden toothed wheel fixed at the top of a vertical driveshaft, which extends down through a large hollow wooden post to the bottom, where its weight rests on a thrust bearing. At the lower end of the vertical shaft, a small wooden gear wheel meshes with the teeth of a large gear wheel which is fixed to the pump shaft on which the pump is mounted.

In the second half of the sixteenth century, the relatively simple hollow post units evolved into very large smock and cap tower units used extensively for land reclamation projects. Although proportionately larger than the hollow post units, the internal machinery is similar. Each of these units could pump as much as 57 m<sup>3</sup> of water per minute to a height of 1.5 m. The Archimedean screw, consisting of a wooden spiral enclosed in a wooden casing, was adapted to drainage wind pumps in 1634. Using such a device, it was possible to increase the lift to 5 m.

#### (b) *Meadow type*

The meadow type with a 4-m diameter, four-blade rotor, is an adaptation of the hollow post type, and is still widely used in the northern area. This unit has a



wooden body resting on a concrete foundation. Steel ball bearings are used on the shafts of the traditional power transfer system of wooden gearing. At the rear of the movable cap is a large tail vane which incorporates a spring-operated control mechanism for turning the rotor out of the wind during periods of very high wind. The base of the structure encloses a large-diameter, slow-speed, centrifugal pump.

#### (c) *Tjasker type*

The Tjasker type is the simplest and smallest of the Netherlands water pumping windmills. It consists essentially of a long wooden shaft mounted at an angle of 30° to the horizontal, the upper end of the shaft carrying four cloth sails on a wooden framework, 6 m in diameter, and the lower end terminating in a closed Archimedean screw. The shaft is supported by a wooden A-frame and the assembly can be moved in a circle around a central pivot pole to point the sails into the wind.

### 6. Tanzanian design

A low-cost locally-constructed windmill suited for deep borehole water pumping has been developed by a team in co-operation with the Ministry of Lands, Settlement, and Water Development, Tanzania (reference W 22). Twelve of these windmills are being constructed for use in Tanzanian villages, and one unit will be displayed in June 1976 at the UNICEF Appropriate Technology Centre, Nairobi.

The 5-m diameter rotor consists of six 0.9 m x 0.7 m corrugated, galvanized metal sheets mounted with a root pitch angle of 45° and a tip pitch angle of 30° on six steel spars. Each blade is cambered along its chord to a 2.7-m radius, and blade pitch control is incorporated into the hub mechanism. The tail vane is of sheet steel. The tower is constructed from three 6-m long galvanized steel pipes. Power transfer by an adjustable eccentric wheel permits adjustment of the reciprocating stroke for different pumping conditions.

### 7. French design

A low-cost multi-blade windmill intended for local construction has been developed by a group of French engineers and tested over a period of 30 months. Prototypes have been on trial at Ougadougou, Upper Volta, and at Agades, Niger, since the end of 1973. A pilot series of 20 windmills was manufactured in 1974 and 1975 and sent for trial and demonstration to Chad, Cape Verde Islands, Niger, Haiti, Laos, Democratic Yemen, Mali and Senegal.

The 3-m diameter rotor has 16 canvas vanes mounted on wooden spars with a variable pitch and self-feathering control mechanism, and a canvas and

bamboo tail vane. A steel crankshaft mounted in metal/teflon bearings converts the rotary motion to vertically reciprocating motion, which is transferred by a wooden connecting rod to an adjustable balance arm. At the starting wind velocity of 7 km/h, with the rotor turning at 10 rev/min, the unit will lift water 6 m at the rate of 120 litres per hour. The maximum rotational speed in higher winds is 60 rev/min. The simple wooden guyed pole structure is 4 m high. The cost of this windmill is somewhat greater than \$US 400. Details of construction and assembly are available (see reference W 23).

### 8. Savonius rotor

The Savonius rotor has been widely publicized as being appropriate for use in developing countries (reference W 24). This vertical-axis rotor incorporates two semi-cylindrical surfaces, mounted on a vertical shaft so that the view from above presents the shape of the letter S. Typical models of this design are made from two halves of an oil drum split longitudinally. The potential advantages of this system are that it will accept the wind from any direction, and the rotor is simple and inexpensive to build. Many organizations and individuals throughout the world have experimented with this design and found it to be generally unsatisfactory for practical application (reference W 25). The disadvantages are small collection area, large weight/surface area ratio, low aerodynamic efficiency, vibration problems and difficulty in making a connexion to a pump. Potential is seen for this design only in applications requiring very little power, such as the stirring of algae cultures and the starting of Darrieus rotors.

## B. INDUSTRIALLY PRODUCED MECHANICAL WIND PUMPS

### 1. Multi-vane wind pumps

#### (a) *Usage*

The most commonly used and widely distributed type of wind pump is the slow-running multi-vane metal fan driving a piston pump. Originally developed in France, the multi-vane windmill first attained widespread use in the United States of America in the late 1800s for domestic and livestock water supply. Use and manufacture have gradually spread to many parts of the world, especially the United Kingdom, Australia, South Africa and South America. Local adaptations of this design have been developed in the Philippines, India, Syria, Indonesia and Thailand, but have not been widely used in those countries because of the high cost of all-metal construction and economic and technical limitations on the capability of the owners to undertake proper maintenance. Many multi-vane wind pumps made in the United States of America and Australia have been exported to developing countries throughout the world, often on a

subsidized basis, but these units often cease functioning within 10 years because of the lack of skilled maintenance.

### (b) Components

Although there may be variations between different manufacturers, the basic components are as follows:

**Rotor** — The windwheel or fan consists of 8 to 24 galvanized sheet steel vanes which are cambered to provide optimum aerodynamic efficiency. The vanes are carefully balanced, and fastened to two concentric steel rings which are supported by five or six tensioned steel spokes connected to a cast steel hub. This assembly is mounted on a shaft which runs in automatically-oiled ball or babbitt bearings, or wooden bearings. The diameter of the rotors available ranges from 1.8 m to 9 m.

**Gearbox** — The shaft is mounted in a cast iron head unit incorporating a reciprocating crank system. In smaller models, a speed reduction gearing of ratio 2:1 to 4:1 permits the rotor to turn with a relatively low torque load and deliver a longer stroke to the pump connecting rod than if it were connected directly to a crankshaft.

**Turntable** — The gearbox is mounted on a turntable, through which passes the reciprocating steel connecting rod and the tail pullout chain.

**Tower** — A three-legged or four-legged angle iron lattice tower is used, varying in height from 5.5 to 18 m. The large quantity of steel used for the towers is a major expense. The tower is mounted directly above, or adjacent to, the water supply, on a concrete foundation.

**Control devices** — The rotor is pointed into the wind by a galvanized sheet steel tail vane. The rotor may be turned parallel to the wind, when necessary during exceptionally strong winds (above 60 km/h), by means of a cable winch or lever fitted at the base of the tower and connected to the tail pullout chain. In some models, a brake on the rotor operates simultaneously with the tail pullout mechanism.

The main shaft is often offset slightly from the centre of rotation of the turntable, so that in higher winds the rotor is automatically turned partially out of the wind by the unbalanced distribution of wind pressure at the centre of rotation.

**Pump** — Pumps are commonly of the single-acting reciprocating piston type. The piston cylinder is usually of brass or PVC plastic 5-15 cm inside diameter. The piston incorporates a single or double leather seal and a one-way valve. A steel ball or leather flap valve is fitted at the base of the cylinder and a third one-way valve may be fitted at the bottom of the inlet pipe.

**Storage tank** — Water is usually stored in an elevated steel tank for domestic water supply and in a ground-level tank or pond for stock watering.

### (c) Construction materials and skills

Multi-vane windmills are shipped from the manufacturer complete and ready for assembly, with ordinary mechanic's wrenches and screwdrivers, by semi-skilled workers. Considerable skill and dexterity are required to lift up the tower, the gearbox assembly and the rotor, which are each quite heavy.

### (d) Operation and maintenance

Once assembled, the only normal maintenance required is annual replacement of the oil in the gearbox. After several years, the replacement of damaged rotor blades, worn bearings and worn pump valves and seals may be required. These tasks may present some difficulty in rural areas, especially when the new part must be obtained from the manufacturer.

### (e) Performance

The standard types start working with a wind velocity of 6-8 km/h and have a constant operational speed and output for wind velocity of 28 km/h and above. (It should be noted that the rotational speed decreases as the rotor diameter increases, so that selection of a rotor larger than that required to supply the necessary torque to the pump to start operating may have a negative effect on pumping rate).

Table 1 gives an example of the performance of a typical multi-vane wind pump (Comet) operating at a mean hourly wind velocity of 12.4 km/h.

Table 1. PERFORMANCE OF COMET WIND PUMP

Pump diameter (cm)	Rotor diameter							
	2.44 m		4.88 m		7.32 m		9.14 m	
	Lift (m)	Output (m <sup>3</sup> per day)	Lift (m)	Output (m <sup>3</sup> per day)	Lift (m)	Output (m <sup>3</sup> per day)	Lift (m)	Output (m <sup>3</sup> per day)
5.08 . . . . .	38	5.8	167	9.6	—	—	—	—
7.62 . . . . .	19	13.1	83	21.8	237	23.4	—	—
10.16 . . . . .	11	23.2	49	38.2	136	41.4	236	37.6
15.24 . . . . .	5	47.7	21	86.4	58	93.4	109	84.3
20.32 . . . . .	—	—	11	154	34	163	61	149
30.48 . . . . .	—	—	—	—	15	366	28	336
45.72 . . . . .	—	—	—	—	7	832	12	746

## 2. Lubing wind pump

The Lubing company in the Federal Republic of Germany manufactures a highly reliable precision-made wind pump, which has three aerodynamically-shaped high speed rotor blades mounted down-wind in a coning angle. Speed control is achieved through radial feathering of the rotor blades by centrifugal weights mounted on each blade shaft. The single guyed steel pole tower is hinged at the base so that the complete unit may be easily lowered to the ground by means of a winch at the base of one of the three guy cables, which is a useful feature in typhoon areas. This wind pump will operate unattended for long periods of time but it is very expensive.

## 3. Sparco wind pump

The Sparco wind pump, manufactured in Denmark, is intended for cattle watering. It is mounted on a single guyed steel pole tower, and has curved plate steel alloy blades individually mounted on steel shafts, and self-regulating, with a tail for directional orientation. All moving parts are mounted in sealed ball bearings.

## 4. Bosman wind pump

The Bosman wind pump is manufactured in the Netherlands for small-scale drainage pumping on farms and grazing land. It consists of four flat steel plates, twisted to achieve a low pitch angle at the tip and high pitch angle at the root, and fixed to four steel arms to give an effective diameter of 3 m. The rotary motion of the horizontal main shaft is transferred through 90° by a sealed oil-bath gear system to a vertical shaft, which runs down the centre of the 4-m high steel lattice tower to a submerged centrifugal low-lift pump. A unique control system incorporates two tails mounted 90° apart and capable of simultaneous radial twist, so that only one tail is vertical at any time, the operation being controlled by the water level.

Detailed studies are being made at Eindhoven University, Netherlands, on the potential for further development of plate blades such as those used on the Sparco and Bosman wind pumps.

### C. ELECTRIC PUMPS POWERED BY WIND-GENERATED ELECTRICITY

High-speed wind-electric generators can be used to pump water by transmitting power to electric motors connected to centrifugal immersion pumps (reference W 26). This method has several advantages: (a) the pump and wind motor need not be mounted at the same location, e.g. the generator may be located on a windy hill and the pump on a river flat; (b) one

generator may be used to operate several pumps; (c) several generators may supply a single pumping station, e.g. in Germany a 64 kW pumping station is supplied by eight Allgaier wind power plants; (d) the manufacture of wind-electric generators may be carried on independently of the manufacture of the pumps or the intended application; (e) the efficiency of high-speed wind rotors and high-speed centrifugal pumps is greater than the efficiency of slow-speed wind rotors and piston pumps; (f) energy may be used from time to time for other purposes.

Despite these advantages, the method has not been widely used, because of the high capital cost of large wind-electric generators.

## III. STATUS OF WIND-DRIVEN ELECTRIC GENERATORS

The first wide-scale use of wind-generated electricity occurred in the 1930s, following the development of medium-speed generators for automobiles, and using the increased knowledge available of aerofoils and aircraft propellers.

Wind-electric generators can be broadly classified as suitable for small-scale generation for localized use, or large-scale generation for supply to a distribution grid.

### A. SMALL-SCALE GENERATION

During the late 1930s more than 300 companies around the world were producing various types of small wind-electric generators with rated output as high as 3 kW. Following the rapid development of fossil-fueled central electric-generating stations and the development of distribution systems, wind-electric generators tended to become uneconomical. At present there is a much smaller number of manufacturers, but many new developments are taking place (see reference W 27).

#### 1. Elektro wind generators

The Elektro company in Switzerland, established in 1938, manufactures a large range of DC wind-electric generators with specifications as summarized in table 2.

Most models are available with special dust-proof bearings, and insect-proof wiring for use in tropical areas. A DC/AC inverter is also available.

These highly reliable windmills are used around the world in all extremes of climate to supply power for communications relay stations and navigation aids.

Table 2. ELECKTRO WIND-ELECTRIC GENERATORS

Model	Rated output (watts)	Rated wind velocity (km/h)	Rated voltage (V)
W 50 . . . .	50	—	DC 6/12/24
W 250 . . . .	250	—	DC 12/24
WV 05 . . . .	600	—	DC 12/24/36
WV 156 . . . .	1,200	37	DC 12/24/36/48/65/ 110
WV 256 . . . .	2,200	35	DC 24/36/48/65/110
WV 356 . . . .	4,000	38	DC 48/65/110
WVG 506 . . . .	6,000	42	DC 65/110
WV 15 W . . . .	1,200	37	AC 110, 1-phase
WV 250 . . . .	2,000	35	AC 110, 3-phase
WV 35 D . . . .	3,500	38	AC 110/220, 3-phase
WVG 50 D . . . .	5,000	42	AC 110/220, 3-phase

### 2. Aerowatt wind generator

The Aerowatt company in France manufactures several models of exceptional wind-electric generators especially adapted for long periods of unattended reliable operation in severe environments. Specifications are summarized in table 3.

Table 3. AEROWATT WIND-ELECTRIC GENERATORS

Model	Starting wind speed (km/h)	Rated wind speed (km/h)	Rated output (watts)	Rated voltage (V)
24 FP 7 . . . .	14	25	28	24
150 FRP 7 . . . .	11	25	130	24
300 FP 7 . . . .	11	25	350	110
1100 FP 7 . . . .	11	25	1,125	110, 220, 380
4100 FP 7 . . . .	14	27	4,100	110, 220, 380

These units are frequently used to supply power for critical remote installations, such as communications relay stations and navigation aids.

### 3. Dunlite wind generator

The Dunlite company in Australia manufactures two models of high quality reasonably-priced wind-electric generators. These have been used in remote places in Australia and the ESCAP region for the past 30 years for domestic power supply as well as power supply to communications relays and navigational aids. Specifications are summarized in table 4.

Table 4. DUNLITE WIND-ELECTRIC GENERATORS

Model	Starting speed (km/h)	Rated speed (km/h)	Rated output (watts)	Rated voltage (V DC)
L . . . . .	—	—	14	32, 36
M . . . . .	16	40	2,000	24, 32, 48, 115

### 4. Winco battery charger

The Winco-Dynatechnology company in the United States of America manufactures a wind-electric battery charger model No. 1222 H. This device has a starting speed of 11 km/h and a rated speed of 37 km/h and delivers 14 amperes at 15 volts DC.

### 5. Lubing battery charger

The Lubing company in the Federal Republic of Germany manufactures a wind-electric battery charger, based on 25 years of experience in the design and construction of wind-electric generating units.

The rotor consists of a propeller with three aerodynamically profiled blades made of epoxy resin reinforced with glass fibre, and a centrifugal governor is provided to limit rotor speed to approximately 600 rev/min. Three additional smaller blades provide a starting facility at a wind velocity of 12-14 km/h. Transmission of power from the shaft to the special brushless AC generator is by means of a two-stage oil-bath gearbox.

The resulting AC output is transformed to 24 V, rectified and stored in batteries. Electronic controls regulate the charging of the batteries automatically and, when the battery voltage reaches 28.5 V, the charging current is automatically switched off. The designed output for various wind velocities is:

Wind velocity (km/h)	—	14	22	29	36	43
Output (watts)	—	24	136	325	400	400

### 6. Bucknell wind generator

The Bucknell company in the United States of America manufactures a 12 V 200 watt wind-electric generator.

### 7. Enag wind generator

The Enag company in France manufactures three models of wind-electric generators:

Eolienne, 400 watts, 24/30 V

Super Eolienne, 1,200 watts, 24/30 V

Super Eolienne, 2,500 watts, 110 V

### 8. USSR wind generators

The USSR Institute for Farm Electrification is responsible for several wind-electric generators rated from 0.5 to 25 kW.

### 9. NOAH wind generators

NOAH company in the Federal Republic of Germany has recently tested several pre-production prototype wind-electric generators with maximum outputs up to 90 kW with variable voltage and variable frequency AC, suitable for electrical heating and cooling, water pumping and hydrogen production.

### 10. DAF wind generators

The DAF company in Canada is currently undertaking the manufacture of two models of vertical-axis Darrieus rotor wind-electric generators. Selected characteristics are given in table 5.

Table 5. CHARACTERISTICS OF DAF WIND GENERATORS

Average wind velocity per month (km/h) . . . . .	14.4	17.6	20.8	24.0	28.8
Average monthly kWh output at 110 V (4.6-m diameter) . . . . .	110	210	360	560	1,000
Average monthly kWh output at 24 V (4.6-m diameter) . . . . .	110	190	290	420	680
Average monthly kWh output at 24 V (6-m diameter) . . . . .	210	400	680	1,070	1,900

### 12. Windworks battery charger

The Windworks company in the United States of America has prepared a plan for a 12 volt DC wind-electric generator (reference W 9). The estimated power output is as follows:

Average wind velocity per month (km/h)	16	19	22	26
Average monthly output (kWh)	86	150	236	350

Considerable time, skill, specialized power equipment and some special materials are required for construction of this unit.

### 13. Brace wind generator

The Brace Research Institute in Canada has designed and tested a 9 kW 110-230 V AC wind-electric generator for use in developing countries (reference W 10). This design, intended for local assembly, utilizes automobile and truck components and a 9.8-m fibreglass rotor manufactured in Canada. The estimated electrical output is as follows:

Average wind velocity per month (km/h)	16	19	22	26
Average monthly output (kWh)	740	1,278	2,030	3,030

### 14. Kedco battery charger

The Kedco company in the United States of America has begun production of a simple, reliable

This type of unit has been especially designed for developing countries and a preliminary economic analysis (reference W 28) indicates that this design has an economic advantage over some other machines.

### 11. Sencenbough wind generator

The Sencenbough company in the United States of America provides a complete kit for construction of Model 750-14 wind-electric generator. This 790 watt, 14.4 V DC device has a starting velocity of 12 km/h rated wind velocity of 29-32 km/h and maximum operating velocity of 48 km/h, and is equipped with a 3.7-m diameter propeller.

wind-electric generator. Model 1200 produces 1,200 watts, 85 amps at 14.4 V DC at a rated wind velocity of 34 km/h, the starting wind velocity being 11 km/h.

### 15. Models no longer manufactured

Many of the wind-electric generators previously manufactured in the United States of America were of simple reliable construction, and several of these units are still providing reliable service. A detailed study of the components of these units is recommended prior to finalization of any design of wind-electric generators for manufacture and use in the region.

### B. LARGE-SCALE GENERATION FOR SUPPLY TO DISTRIBUTION GRIDS

From 1930 to the late 1950s, many large prototype wind-electric generators, the largest of which was rated at 1,250 kW, were constructed and tested in a number of countries, including Denmark, the United Kingdom, France, Germany, the USSR and the United States of America. Although technically successful, they were not generally adopted because they were not cost-competitive with large-scale fossil-fueled generation. New activities in this field have occurred recently (reference W 29).

### 1. ERDA projects

In 1973, considering recent technological developments in related fields, the United States National Aeronautical and Space Administration (NASA) and the National Science Foundation undertook a major wind energy development programme which was followed up by the Energy Research and Development Administration (ERDA) in 1975.

The first ERDA prototype wind-electric generator commenced operation in November 1975. The general specifications of this Model 0, 100 kW experimental unit were:

Cut-in wind speed (first load applied)	13 km/h
Rated wind speed (100 kW at busbar)	28 km/h
Maximum operating wind speed	95 km/h

In 1976, ERDA is planning construction of two prototypes each rated 200 kW, and commencement of a significant programme for development of small wind-electric generators.

### 2. Danish wind-electric generators

In 1941-1943, the Smidth company in Denmark manufactured twelve 60 kW and six 70 kW DC wind-electric generators which supplied a local electricity grid for about 10 years. In 1957, the same company installed a 200 kW AC wind-electric generator, which supplied electricity to the national distribution grid for 10 years.

In 1974-1975, the Danish Academy of Technical Science re-examined the possibilities of large-scale wind-electric generation and concluded that wind energy could supply 10 per cent of the country's electricity. Large Darrieus rotors supported on icosahedron frames were proposed as an appropriate design.

### 3. French wind-electric generator

In 1957 an 800 kW 3,000 V wind-electric generator was constructed and operated for 5,000 hours, including 600 hours connected to the distribution grid. In the early 1960s, the NEYRPIC organization constructed a 1,000 kW, 3,000 V asynchronous AC wind-electric generator which supplied a maximum output of 220,000 kWh in November 1963. A reduction in petroleum prices discouraged plans for widespread use of these machines.

### 4. Canadian wind-electric generator

The Canadian National Research Council is proceeding with a plan for erection of a 200 kW Darrieus

rotor wind-electric generator which is expected to supply 500,000 kWh per year to a local distribution grid.

### 5. New Zealand study

The New Zealand Aerospace company is studying a 10 kW version of the Darrieus rotor design as a model for a larger unit intended to be connected to the national grid.

## IV. WINDMILLS FOR OTHER USES

In many countries, windmills have been traditionally used for grinding grains, oilseed pressing, sugarcane crushing, wood cutting and other semi-industrial tasks. Construction and performance details of some of these machines are available in the literature and present some potential for adaptation for use in the region.

### A. MULTIPLE USAGE

Considerable potential appears to exist for adaptation of wind rotors already used in the region for water pumping, such as the Greek sail configuration and the Thai high-speed type, to tasks able to use variable intermittent mechanical power, including grain threshing, winnowing and grinding, concrete mixing, load lifting and compost grinding.

It would be desirable to consider development of wind utilization systems that can be used for several purposes, thus allowing the windmill to be used whenever wind is available, and this would depend largely on the proper selection or development of the utilization devices. Some activity in this field has been initiated by the Social Work and Research Centre at Tilonia in India, and some commercial applications are being developed by the Bharat Heavy Electricals company in India.

### B. CHINESE WIND-POWERED PLOUGH

The use of a wind-powered cable plough in China has been reported in reference W 30. This device incorporates a wind-powered winch consisting of an upper and a lower capstan and a coupler capable of changing direction. A bi-directional plough is connected to a continuous cable which passes through a pulley at the end of the field. The system is operated by two persons, one person operating the windwheel and winch and the other person operating the plough, and can plough 0.25 to 0.8 hectares of land per day, depending on wind velocity.

## V. SELECTION AND MATCHING OF TRADITIONAL COMPONENTS FOR DESIGN OF NEW HYBRID WINDMILLS

Components may be broadly classified as follows:

*The rotor* consists of a surface area for receiving the pressure of the wind and a support structure which converts the horizontal pressure of the wind to rotary motion.

*The hub* connects the rotor to the main shaft.

*The main shaft and bearings* support the weight of the rotor and carry the rotary motion to a power transfer mechanism.

*The power transfer mechanism* carries the rotary motion of the shaft to the power utilization device.

*The power utilization device* converts the mechanical power delivered to it into some form of useful work.

*The tower* supports the rotor above the ground at a height where it can receive a useful amount of wind and in most cases rotate freely.

*The orientation system* consists of a turntable, shaft carriage and sometimes a tail. It is required on horizontal axis devices to maintain the plane of rotation of the rotor perpendicular to the direction of wind flow.

*The control system* is required to match the performance of the windmill to the available wind and the energy demand, and to prevent structural damage in high winds.

The primary factors determining the design of each component are: function, physical stress related to wind speed and load demand, materials available and the skills and tools required to work with these materials. The matching of individual components into a system should aim to have all components able to withstand similar maximum stress loads and to require a minimum number of different materials, skills and tools for assembly of the system.

A large number of successful components is described in detail in the literature. The construction and performance characteristics of an appropriate selection of these, and others not reported, could be carefully documented for each major use (mechanical, electrical) for two power ranges (less than 5 kW, greater than 5 kW). Such documents would be most useful for the development of hybrid wind-energy systems for specific applications.

## VI. CURRENT INTERNATIONAL ACTIVITIES

Several international organizations are involved in the development and promotion of small-scale wind utilization devices.

### A. UNITED NATIONS

The Centre for Natural Resources, Energy and Transport of the Department of Economic and Social Affairs in New York has an expert adviser on non-conventional resources on its staff. In 1974, an economic evaluation of wind-power systems was made.

The Economic and Social Commission for Asia and the Pacific will conduct a roving seminar on rural energy development in 1977.

The Economic Commission for Africa is sponsoring the Second African Meeting on Energy in 1976. This meeting will include discussions on the future role of wind energy utilization in Africa.

The Economic Commission for Latin America is undertaking a study, and experts are being hired to undertake the implementation of wind-electric generators in rural areas of Paraguay.

The Food and Agriculture Organization of the United Nations is currently updating reference W 4.

The United Nations Environment Programme is undertaking the establishment of a few demonstration centres which will integrate solar, wind and bio-mass energy sources into self-sufficient energy systems for communities in some of the typical rural areas of Asia, Latin America and Africa. Sri Lanka has been chosen as the site of the Asian centre.

Although the United Nations Industrial Development Organization is concerned primarily with industrial development, it has several programmes related to energy, and is supplying expert advice to the Government of the Sudan on the utilization of wind energy. A small production unit for the manufacture of water pumping windmills is being set up in Kenya.

The United Nations Children's Fund is establishing a village technology demonstration unit in Nairobi that is expected to be completed by the end of May 1976, and is sponsoring a seminar, commencing 10 June 1976, that will include demonstrations of local renewable energy resources, including two types of windmills, and simple technology for the rural family.

The United Nations Educational, Scientific and Cultural Organization has been supporting activities related to non-conventional energy resources including wind energy and has established a committee to co-ordinate this activity.

**B. UNITED STATES OF AMERICA**

The New Alchemy Institute-East is developing a 6 kW wind-electric generator to be demonstrated as part of the United Nations Human Settlement Programme in Canada. They have also been involved in the development of low-cost wind pumps in India.

Volunteers for International Technical Assistance publishes details on the construction of several varieties of windmill appropriate for construction and use in developing countries and has several voluntary wind-energy experts who respond to enquiries regarding wind energy utilization.

The Energy Research and Development Administration is actively collaborating with several countries in the development of large-scale wind-electric generating devices.

The Technical Assistance Information Clearing House has recently devoted some effort to international co-ordination of work on small-scale wind energy utilization.

The Wind Energy Society of America is concerned with dissemination of wind energy information within the academic and research community. The Society has several international members.

**C. NETHERLANDS**

The Netherlands development foundation TOOL publishes an international newsletter with the aim of increasing communication between technical workers. TOOL is providing direct technical collaboration on wind energy development projects in India, Indonesia and Sri Lanka and has published technical information on windmill construction for use by rural development workers.

**D. CANADA**

The Brace Research Institute has been actively involved in the development of windmill designs and

their implementation in developing countries for several years, and has issued several relevant technical publications.

**E. UNITED KINGDOM**

The Intermediate Technology Development Group has provided direct technical assistance on wind pumps in Africa and has prepared a technical report on this work. It is currently building a prototype wind pump with a 6-m diameter rotor with three metal aerofoil blades, a fail-safe governing device and an improved pump, primarily for irrigation.

The Oxford Committee for Famine Relief (OXFAM) has been active in promoting and financing the development of windmills in India and Africa.

**F. FEDERAL REPUBLIC OF GERMANY**

The Foundation for International Development organized a conference in September 1975.

A Wind Energy Research Institute has recently been established at the University of Stuttgart. This institute will consider problems of wind energy utilization and will hold regular classes in wind energy techniques.

**G. MALAYSIA**

The Malaysian Agricultural Research and Development Institute has recently developed a 6-m diameter, tail-less (down-wind) Greek type sail rotor and peristaltic pump suitable for rural construction, and use for irrigation and drainage of rice fields.

**H. SWITZERLAND**

The World Council of Churches publishes original information on windmill construction for use by development workers.



## THE DESIGN AND CONSTRUCTION OF LOW-COST WIND-POWERED WATER PUMPING SYSTEMS (NR/ERD/EWGSW/6)\*

### INTRODUCTION

Recently there has been an increasing demand for information on designs of water pumping windmill systems suitable for construction with low-cost locally-available materials and skills, and it appears that the general unavailability of properly-documented technical information on indigenous wind pumps is a major factor limiting more widespread implementation of wind pumps in rural areas.

Because of the complex interrelationships of the variables of wind characteristics, water supply, materials and skills at each different locality, adaptation of low-cost wind pumps to new areas without modification or redesign has had limited success in the past. However, such interrelationships may be identified and rationalized, and the design process presented as a sequential flow of information analysis, rational decisions, and calculations, as in the flow chart figure 1.

### I. PRELIMINARY INVESTIGATIONS

#### A. SURVEY OF LOCAL WIND CHARACTERISTICS

A reliable determination of local wind characteristics is required, especially for the period when water pumping is most needed. Summarized average hourly wind velocities (figure 2) are required for preparation of velocity and power frequency curves (figure 3) and power duration curves (figure 4). The maximum wind velocity, and directional distribution of winds (figure 5) should also be determined.

#### B. SURVEY OF LOCAL WATER PUMPING NEEDS

A survey of local water pumping needs should be carried out to determine the total pumping head and the daily water demand on a monthly basis for each likely agricultural and domestic requirement.

#### C. CLASSIFICATION OF WIND ROTORS

Several different types of wind rotors are well-known, but their construction and performance characteristics have not been comprehensively classified in a format suitable for design purposes. Complete information for comparative analysis of rotors should include: starting velocity, rated velocity, maximum operating velocity, tip speed ratio, rated efficiency,

range of diameters, construction materials, rotor solidity (total swept area divided by total frontal area of blades), control mechanisms, velocity/power graph, and, where relevant, root chord, tip chord, root angle, tip angle and aerofoil section. Compilation of these parameters for existing wind rotors would greatly assist the design and development of new hybrid wind-pumping systems.

### 1. Horizontal-axis rotors

(a) The classic Greek type sail rotor (figure 6) is widely used in Greece (references W 7, W 8, W 31), and adaptations are widely used in Thailand (figure 7 and reference W 20) and China (reference W 18). It is suitable for wind pumps because of its high starting torque, low starting speed, low weight and cost, and its ability to be easily adjusted on the occurrence of higher wind velocities. It consists of 6 to 12 triangular cloth sails, each attached to a wooden spar along its longest edge and held tight by a rope leading from the free corner to the adjacent spar tip or circumferential wire between spar tips. Radial wires, leading from the tip of each spar to the tip of a central axial spar, brace the spars against wind pressure. Maximum rotor solidity is about 45-50 per cent. Sail area can be reduced by wrapping each sail one or more times around its spar. This type of rotor appears to be the most appropriate design for use in areas with limited resources of materials and skill. It has been further developed by several organizations for use in India (figure 8 and references W 11, W 32), Malaysia (figure 9), Sri Lanka (reference W 12), Ethiopia (reference W 13) and other developing countries (figure 10 and references W 9 and W 10).

(b) The steel multi-vane fan rotor (figure 11) consists of 8 to 24 curved sheet metal blades mounted on two concentric steel rings supported by 5 or 6 tensioned steel spokes. Rotor solidity is 90-100 per cent. Local adaptations of this design have been developed by the National Aeronautical Laboratory in India, the General Administration for the Development of the Euphrates Basin in Syria, a private company in Thailand, the Bandung Institute of Technology in Indonesia (reference W 33) and USAID (reference W 34). A cloth multi-vane rotor has also been developed (reference W 23).

Multi-vane rotors are characterized by a very low starting wind velocity of 6-8 km/h, and high starting torque, and are normally used in conjunction with a piston pump. They are most appropriate for industrial manufacture and use in areas where the necessity for long-time durability and reliable unattended operation can justify the large capital expenditure required.

\* Prepared by Mr. M. M. Sherman, consultant on wind energy, at the request of the ESCAP secretariat. The views expressed in this paper are the author's own and do not necessarily reflect those of the secretariat or the United Nations.

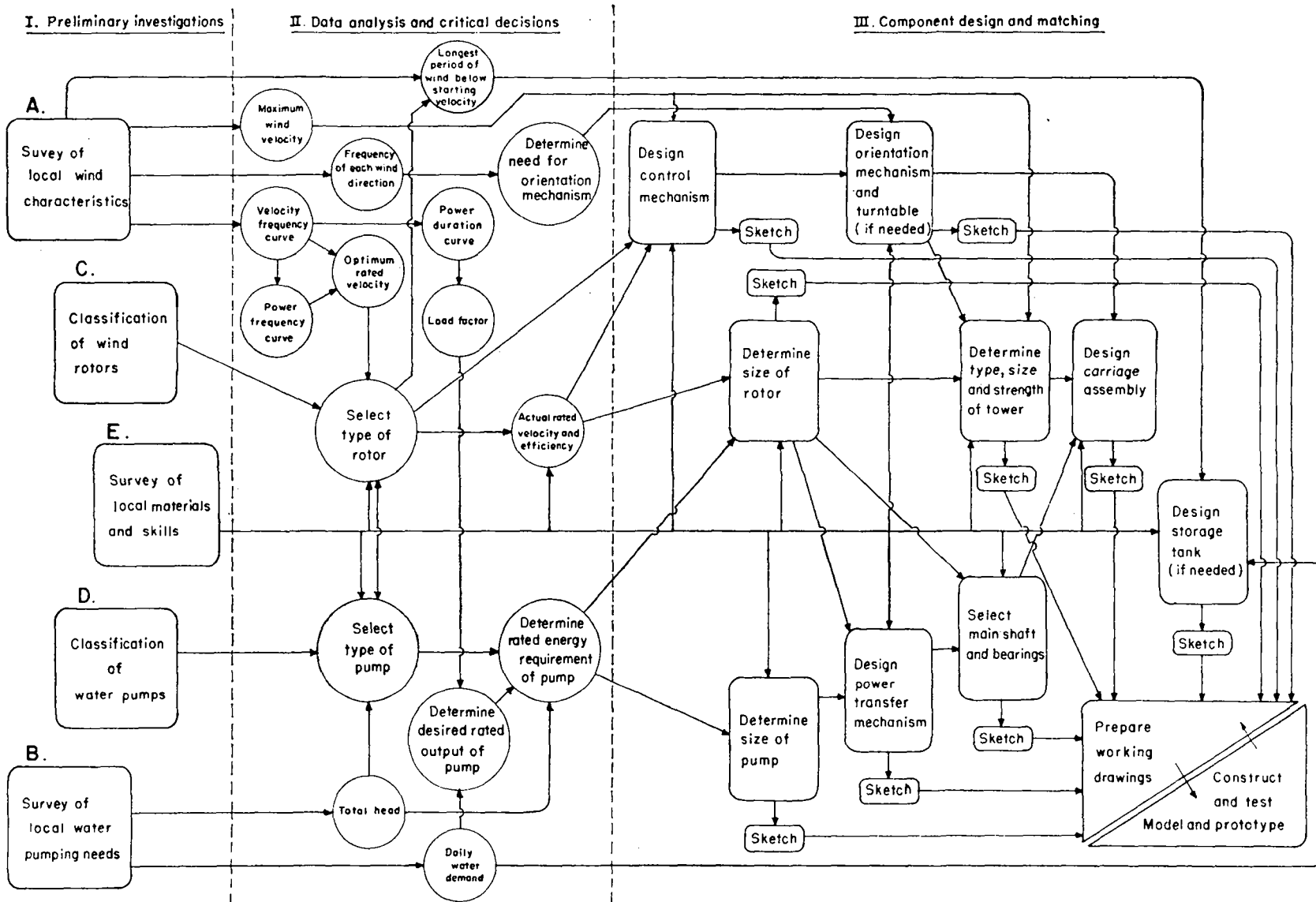

Figure 1. Sequential flow chart for design of water pumping windmill systems

v <sup>1</sup> ( knots )	0	1	2	3	4	5	6	7	8	9
v ( km/h )	0	1.85	3.70	5.55	7.41	9.26	11.11	12.96	14.81	16.67
t (hours duration)	291	32	619	331	857	387	604	219	517	92
v <sup>3</sup> x t	0	202	31,354	56,585	348,687	307,287	828,281	476,714	1,679,402	426,180

v <sup>1</sup> ( knots )	10	11	12	13	14	15	16	17	18	
v ( km/h )	18.52	20.37	22.22	24.07	25.93	27.78	29.63	31.48	33.33	
t (hours duration)	293	23	104	25	14	5	1	0	2	
v <sup>3</sup> x t	1,861,187	194,401	1,140,943	348,631	244,081	107,193	26,013	0	74,052	

Figure 2. Summary of ½ hourly wind velocity readings at Don Muang airport, Bangkok, for March, April and May 1975

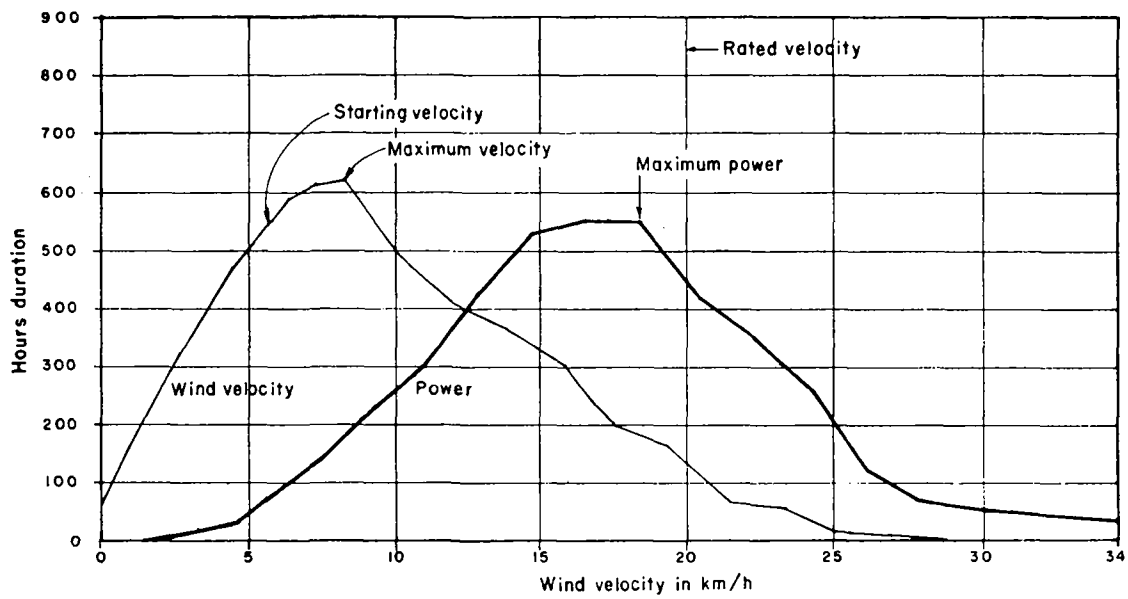

Figure 3. Velocity and power frequency curves

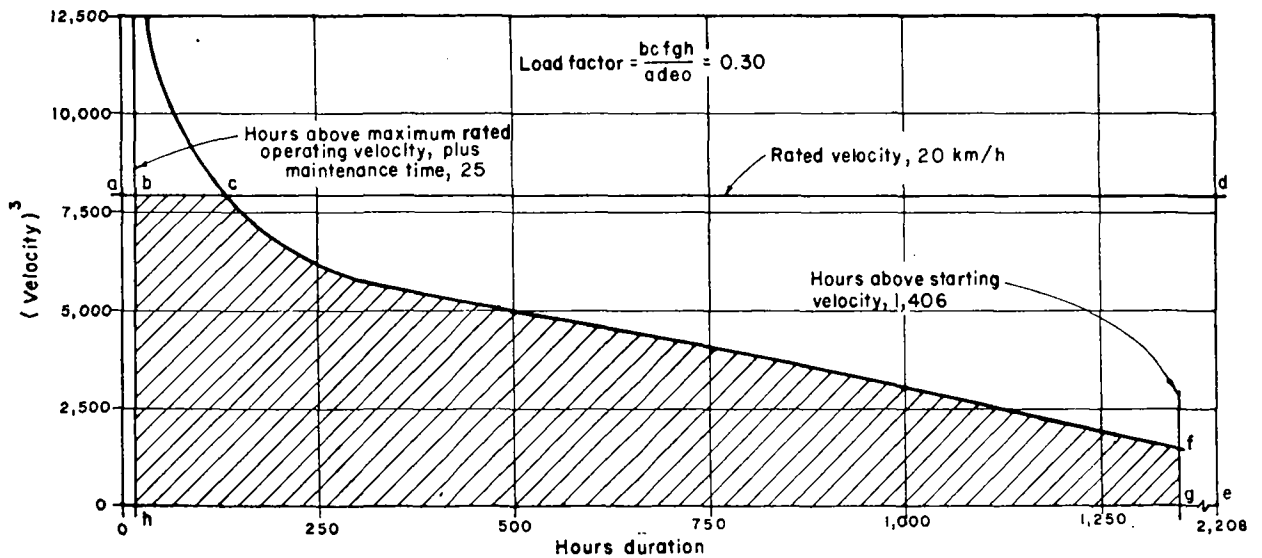

Figure 4. Shape of power duration curve

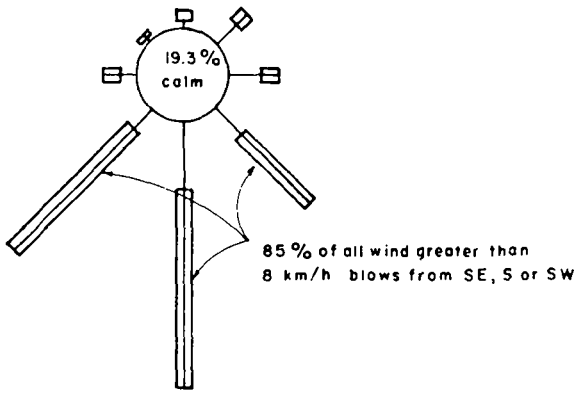

Figure 5. Wind rose, Bangkok, March, April, May

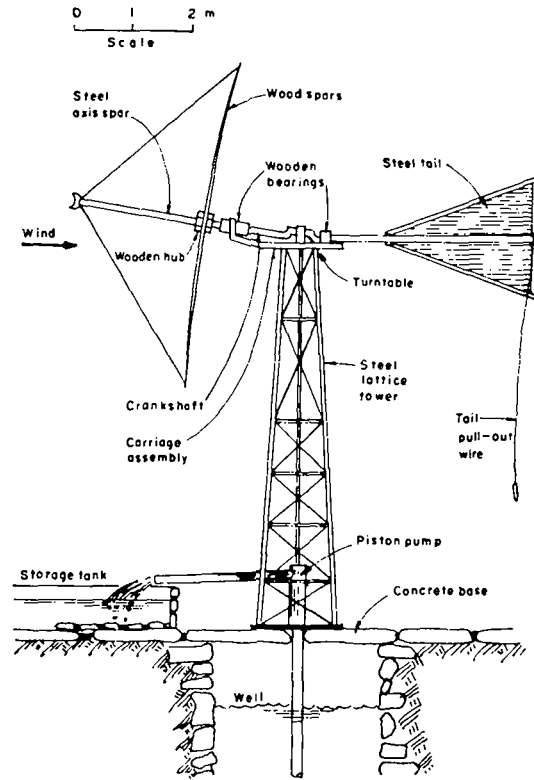

Figure 6. Greek sail rotor water pump

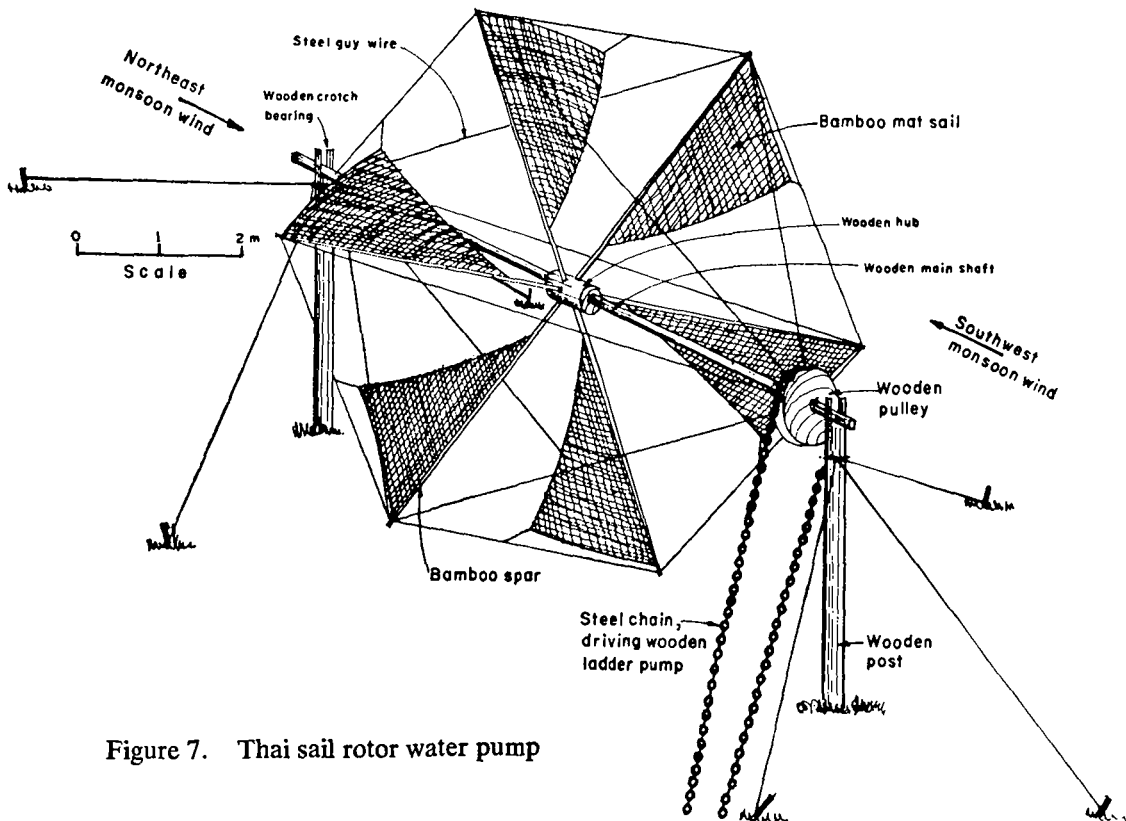

Figure 7. Thai sail rotor water pump

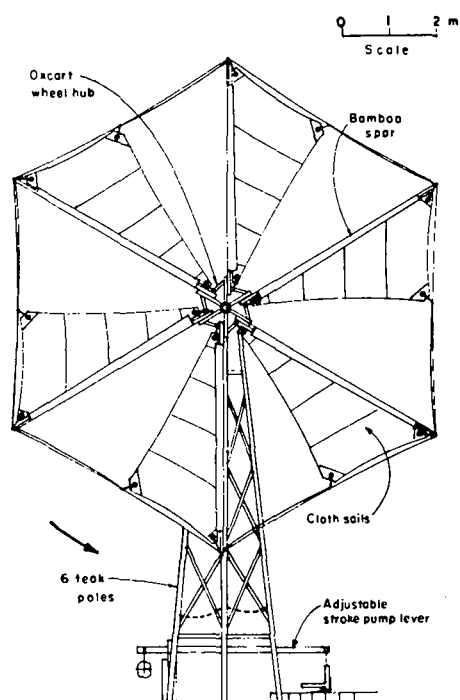

Figure 8. Madurai prototype sail rotor water pump

(c) A very simple and durable rotor consists of four rectangular cambered steel plate blades twisted to give low pitch angle at the tip and high pitch angle at the root (figure 12). Rotor solidity is about 35 per cent. It is commonly used in the Netherlands and Denmark for small-scale drainage and cattle watering, and has also been used on low-cost wind pumps at some salt works in France (figure 13). Optimization investigations are being carried out at the Technical University, Eindhoven, the Netherlands. A 6-blade cambered metal plate rotor has been developed in Tanzania (reference W 22). This type of rotor seems to have considerable potential for use in low-cost water pumping systems because of simplicity of construction, durability and good aerodynamic efficiency.

(d) The Princeton sail wing rotor (figure 14) was developed in 1960 at Princeton University, United States of America. It consists of two blades, each having a double thickness of sailcloth supported by a rigid straight leading edge, rigid tip and root chord sections and a trailing edge cable stretched between the tip and root sections. The ratio of root chord to tip chord is about 3:1. The sail is cut with a catenary arc trailing edge, which allows equal chord tensions to be developed along the length of the sail as a function of the tension at the trailing edge cable. The aerodynamic performance of this rotor is similar to that of conventional rigid rotors, but the weight, cost and complexity of construction are all substantially reduced. Detailed plans of the original Princeton design and an

adaptation for water pumping are available (see references W 35 and W 36).

(e) High-speed propeller-type rotors are not usually considered for water pumping, but they are successfully used for this purpose in Thailand (figure 15) and they may be adapted to high-speed centrifugal pumps. A rotor of this type for use with a wind pump is proposed in reference W 37. These rotors are characterized by high starting velocity, high rotational speed and low starting torque. Most high-speed rotors are carved from wood, although some are made from aluminium by casting or rib construction (reference W 38) or fibreglass (references W 39 and W 40). High-speed rotors for pumping applications would normally be used in conjunction with pumps requiring low starting and constant operating torques, such as square-pallet chain pumps, centrifugal pumps, chain pumps and archimedean screws.

(f) The classic Netherlands type of rotor, consisting of four spars supporting a wooden lattice covered with cloth sails, is best adapted to very large machines where high power output at low rotational speed and high torque are required. Recent use of this type of rotor for water pumping is rare, and its use in new hybrid designs will be limited primarily by the large amount of skilled carpentering required to construct the lattice structure.

(g) Several other horizontal-axis rotors have been used that incorporate four to eight fixed rectangular blades of wood or fibre mat construction; their cost, efficiency and durability are each quite low. Generally speaking, a rotor blade can be made from any flat thin material, including metal, cloth, wood, plastic, bamboo and fibre mats, with appropriate supports.

## 2. Vertical-axis rotors

Many different varieties of vertical-axis wind machines rotating in a horizontal plane have been reported (reference W 41). The primary advantage of these rotors is that they can accept wind from any direction and thus do not require any orientation mechanism, but their construction is usually very bulky and requires a large quantity of material in relation to the effective collection area. These rotors have maintenance difficulties as a result of the large weight resting on one thrust bearing at the base of the main shaft. Aerodynamic efficiency is low because the rotor turns as a result of direct wind pressure which is a function of the square of the wind velocity, unlike horizontal-axis rotors which extract wind energy as a function of the cube of wind velocity. Also, only about half of the rotor blades are doing work while the other half are returning up-wind. However, two classic vertical-axis rotors which may have some practical importance for modern applications, because of their light construction,

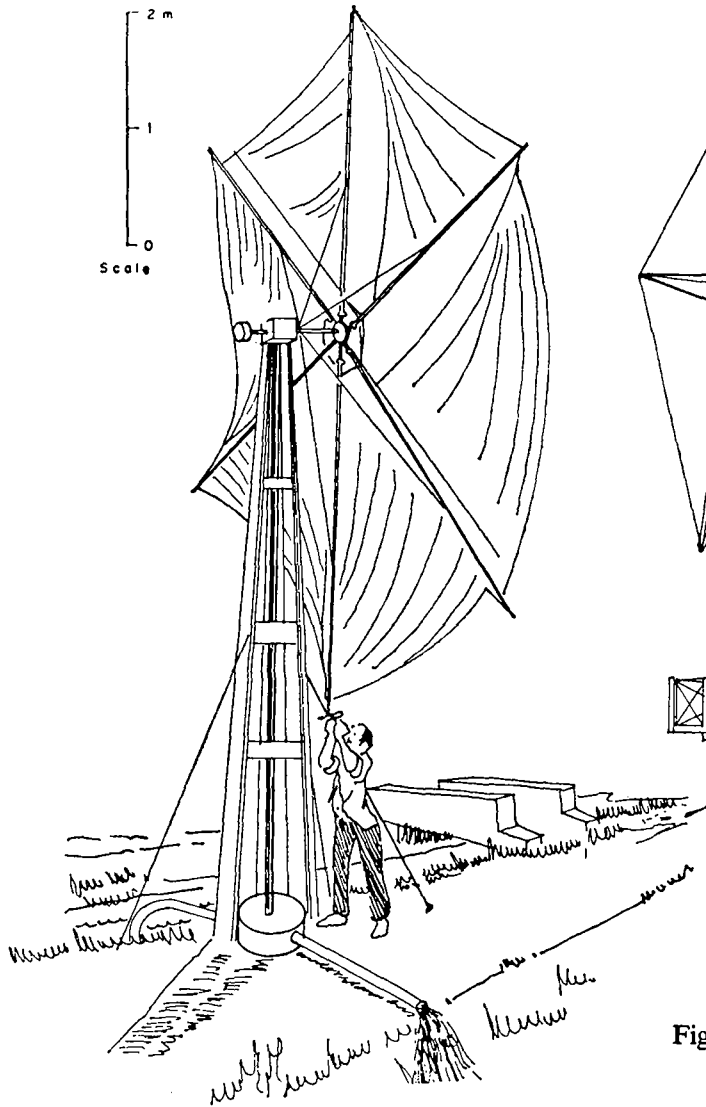

Figure 9. Malaysian Agricultural Research and Development Institute down-wind sail rotor water pump

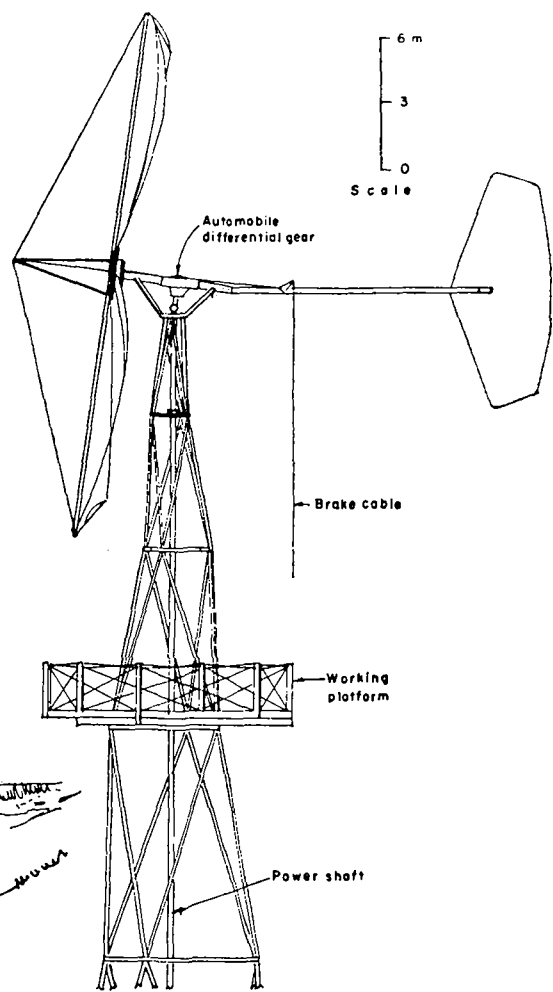

Figure 10. Brace Institute-Windworks sail rotor with octahedron module tower

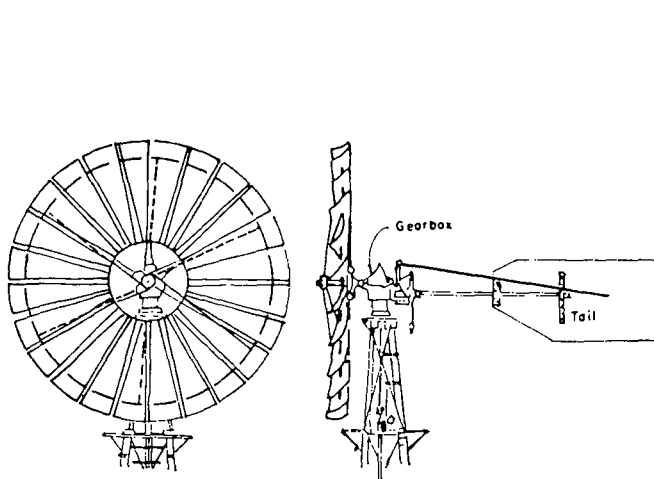

Figure 11. Multi-vane metal rotor

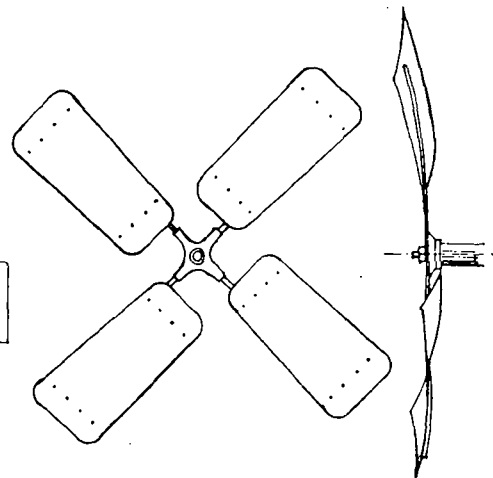

Figure 12. 4-blade metal rotor

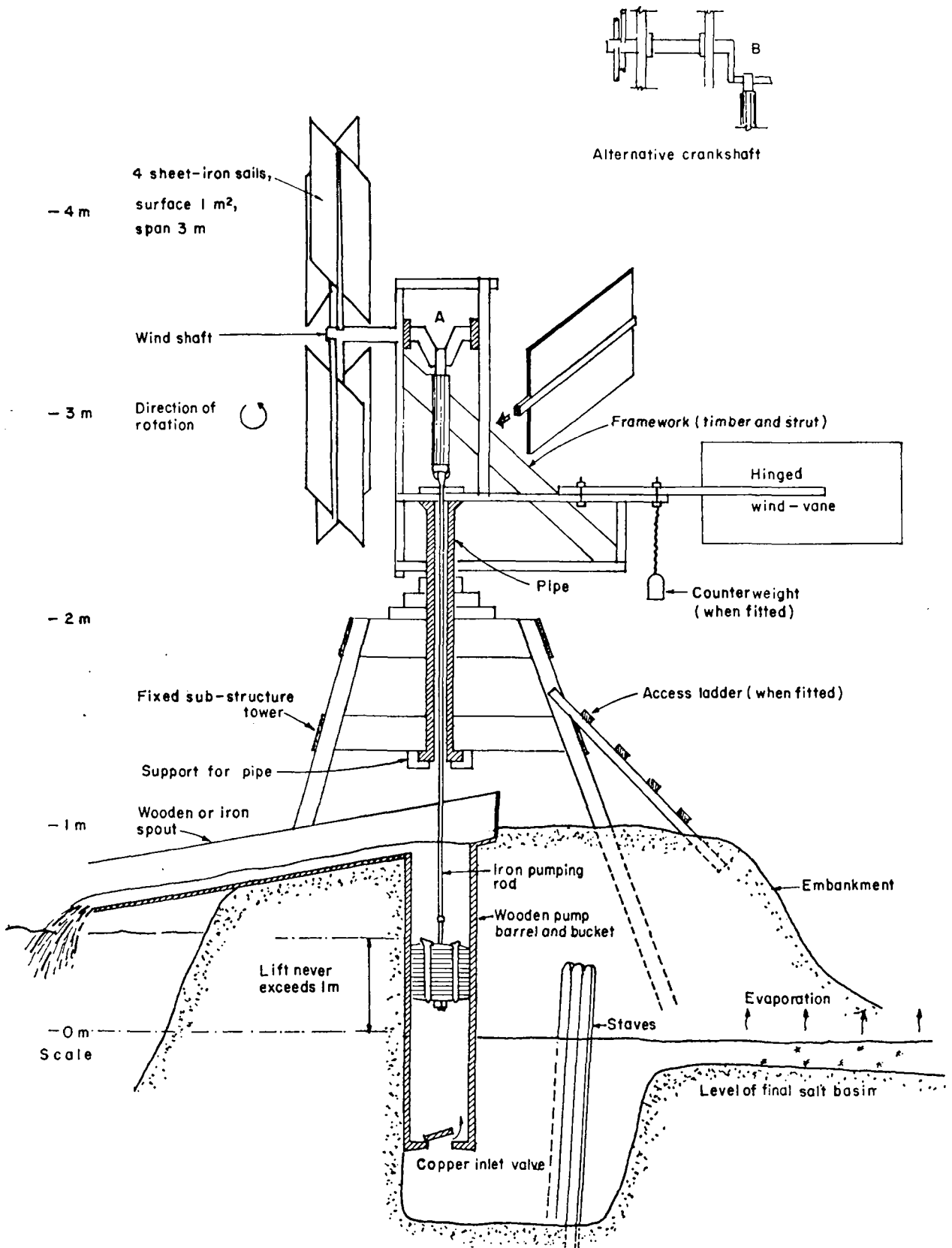

Figure 13. 4-blade metal rotor water pump at Ile de Noirmoutier, France

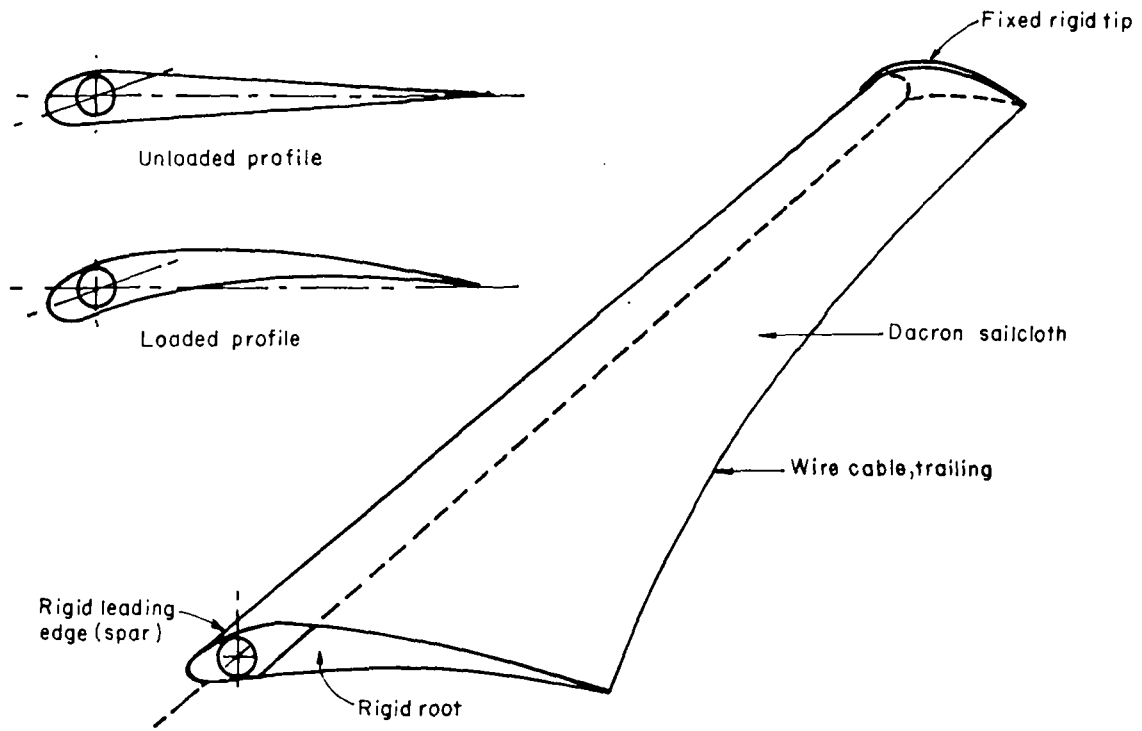

Figure 14. Princeton sail wing rotor blade

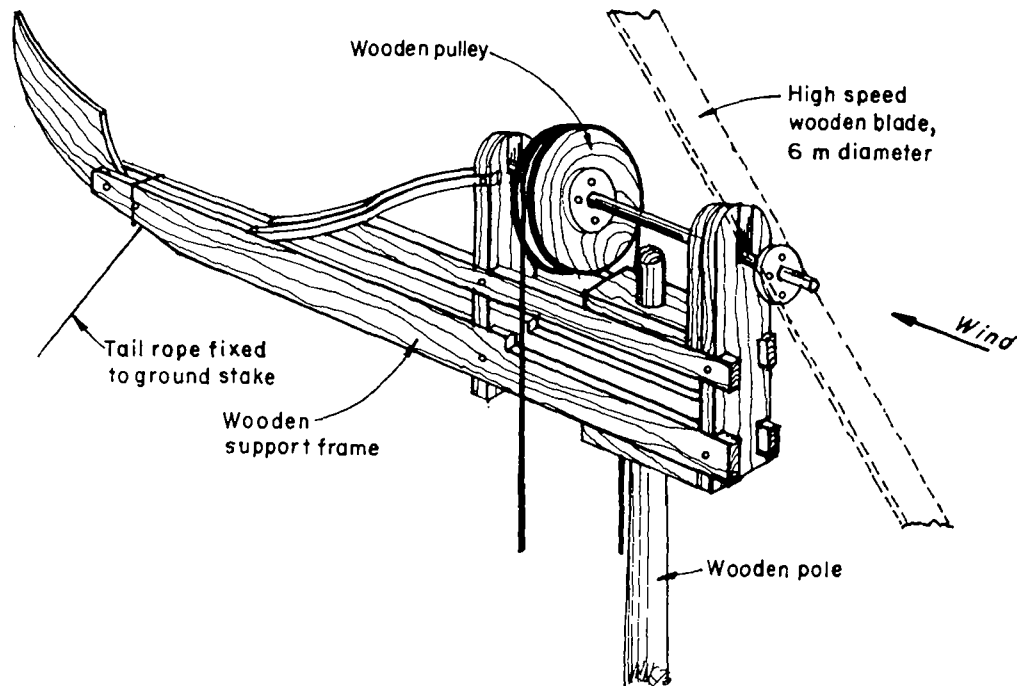

Figure 15. Thai high-speed rotor water pump — wooden mounting assembly



are the Chinese type (figure 16) and the Turks and Caicos Islands type (figure 17). These rotors may be particularly adaptable to Persian wheel and bucket types of water lifts in addition to continued traditional use with square-wooden-pallet chain pumps.

(a) The rotors used in the Turks and Caicos Islands, British West Indies, for pumping salt water to evaporating ponds consist of six triangular cloth jib sails supported along their long edge by a vertical pole, and held by a rope tied from the loose corner to the adjacent vertical pole. Each vertical pole is supported by two horizontal wooden poles which radiate out from the central vertical main shaft. A similar jib-sail rotor utilizing eight sails has been proposed for use in Thailand (figure 18).

(b) The Savonius rotor (figure 19) has been well documented (reference W 25). Its use for practical water pumping and electricity generation has met with limited success only.

(c) The Darrieus rotor (figure 20) consists of two or three constant-chord aerofoil blades bent into a catenary curve and fixed at each end to a vertical axis which is supported by guy wires at the top and connected to a power utilization device at the base (reference W 42). The advantages of this rotor are that, unlike other vertical-axis rotors, a minimal support structure is required, the proportion of materials to total swept area is very low (solidity about 5 per cent), and efficiency is high. The main disadvantage is that it is not self-starting, and construction of the blades from fibreglass reinforced plastics or extruded aluminium is quite expensive. Although it has only recently been developed for electricity generation (reference W 43), it may have some potential for water pumping. Experimental work with a Darrieus rotor powered water pump has recently been undertaken at the National Aeronautical Laboratory in India.

(d) The gyro vertical-axis rotor (figure 21 and reference W 44) is similar to the Darrieus rotor in that it has a high efficiency of about 60 per cent, a very low solidity factor and minimal support structure requirements. This rotor consists of two or three straight symmetrical aerofoil blades supported vertically from horizontal support arms fixed to a vertical central power shaft. Orientation of the blades is reversed twice during each rotation so that maximum lift is achieved. High-speed small-diameter designs have considerable vibration. Further development of this rotor is currently in progress at the Cranfield College of Technology, United Kingdom.

### 3. Three novel concepts

Three novel concepts for utilizing wind power for water pumping have recently been proposed. Although these ideas have not yet been given full-scale demonstra-

tion, their simplicity of operation and low-cost construction makes them worthy of further consideration.

(a) The flapping-vane wind pump (figure 22 and reference W 45) has been designed for use with deep well piston-type water pumps, although it may be adapted to diaphragm pumps, or to a crankshaft flywheel to produce rotary motion. This device consists of a long lever arm with a cloth vane mounted on a horizontal axis at the outer end and a vertical reciprocating power rod at the fulcrum end. The vane can swing freely about its axis within the range of an upper and lower angular stop. Action of the wind on the vane alternatively depresses and lifts the lever arm with resultant power applied to the reciprocating rod. The lever fulcrum is mounted on a pedestal which can rotate on top of the tower in order to allow the vane to automatically orient itself to the direction of the wind. This device is expected to pump 100 m<sup>3</sup> per day from a depth of 40 m with a wind velocity of 16 km/h when the vane area is 29 m<sup>2</sup> and the lever arm is 20 m long. With increasing wind velocity, the amplitude of the up and down motion of the lever arm decreases and the frequency increases, so that the system is self-regulating.

(b) A tree pump has been proposed that converts the horizontal motion of a tree trunk swaying in the wind to reciprocating vertical motion of a piston pump, via cables and pulleys. In this device, the only cost is for the power transfer mechanism and pump. This method is limited to sites with tall unsheltered trees.

(c) A parachute pump (figure 23) has been proposed as a low-cost method of supplying power to traditional animal-powered bucket pumps. This system comprises a large parachute whose circumference ropes are tied to the lift rope. The force of the wind on the parachute pulls the bucket to the top of the well, at which point a rope attached to the centre of the parachute becomes tightened and collapses the parachute so that it may be returned to the starting point by the operator, and the bucket can return down to the base of the well. The parachute is then again allowed to fill with wind to begin another lifting cycle. With this system the only expense is the wind collection device (parachute). The pump and transfer mechanism exist and there is no need for a support structure.

### D. CLASSIFICATION OF WATER PUMPS

A comprehensive international classification of all types of small pumps used for water pumping is urgently needed. Such a classification could include the following information regarding each type of pump; typical schematic diagram, normal range of suction and discharge heads, normal range of output, construction materials and skills required, usual mode of power supply, efficiency, range of operating speed and torque.

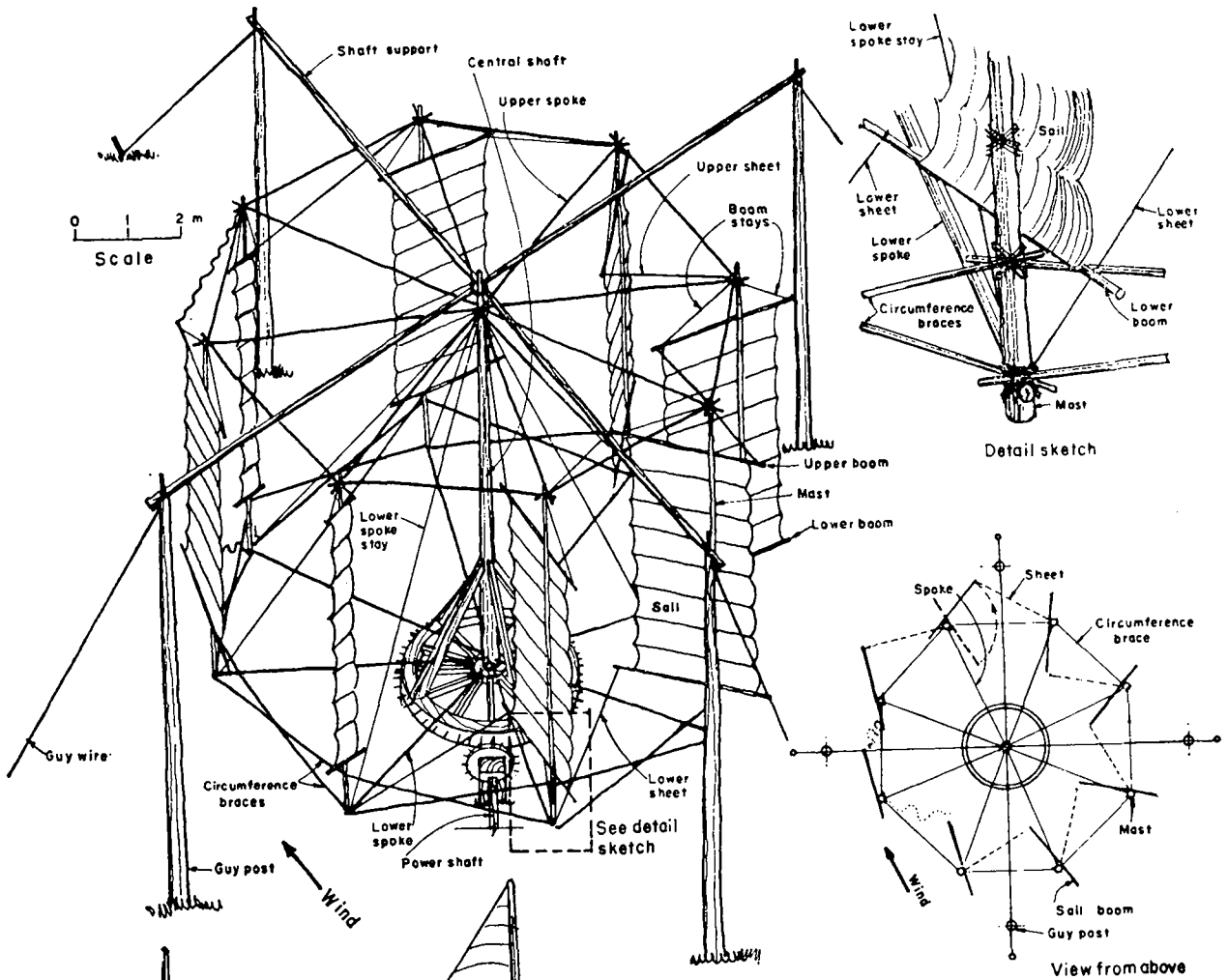

Figure 16. Chinese vertical-axis rotor

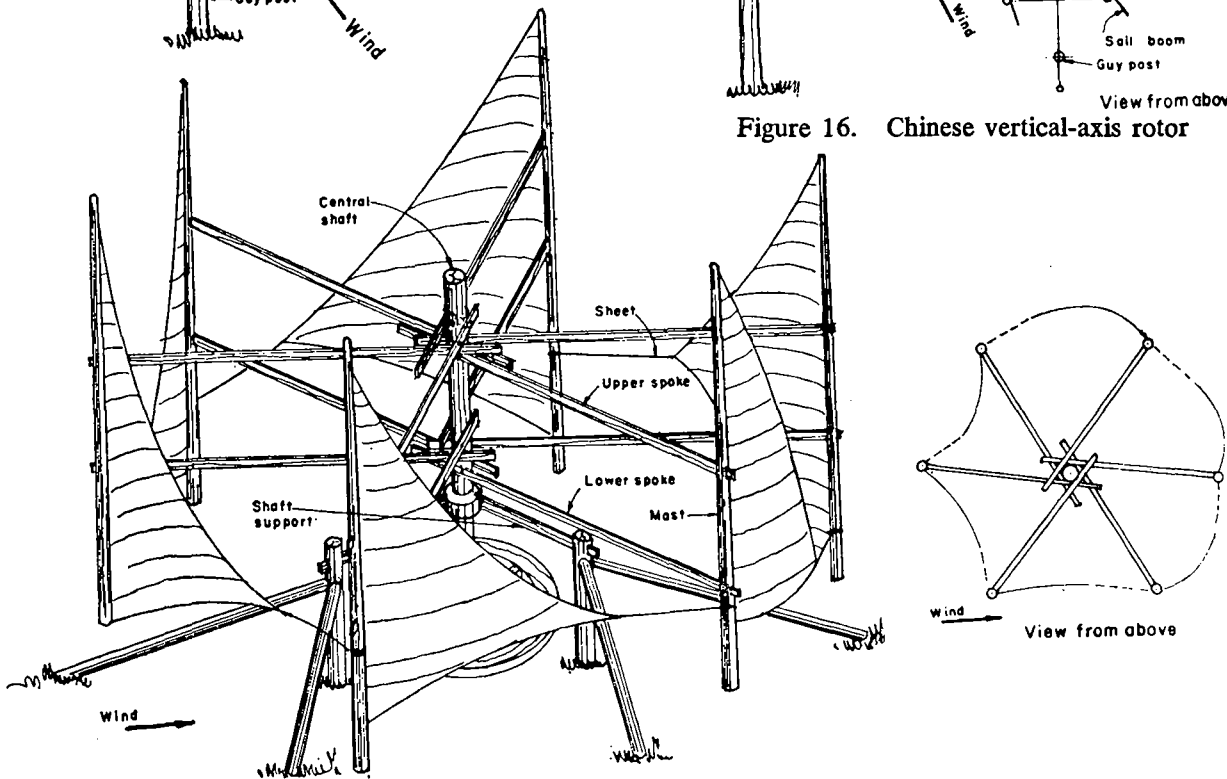

Figure 17. Turks and Caicos islands vertical-axis rotor

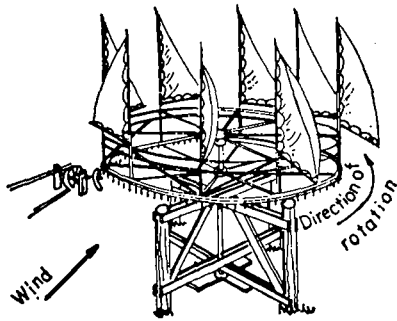

Figure 18. Thai jib-sail rotor

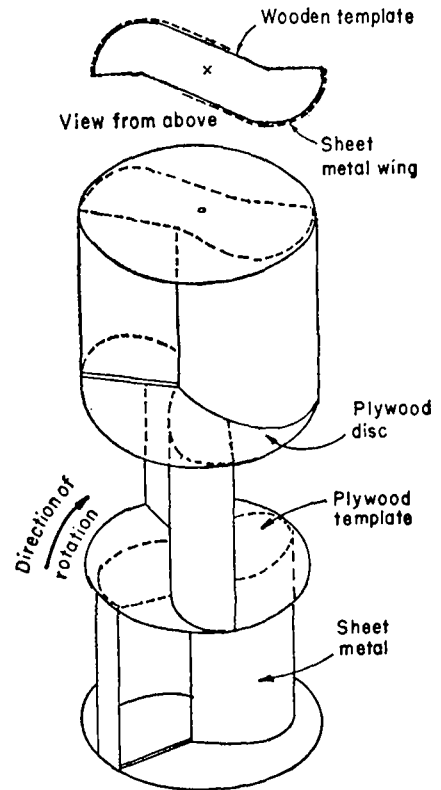

Figure 19. Three-tiered Savonius rotor

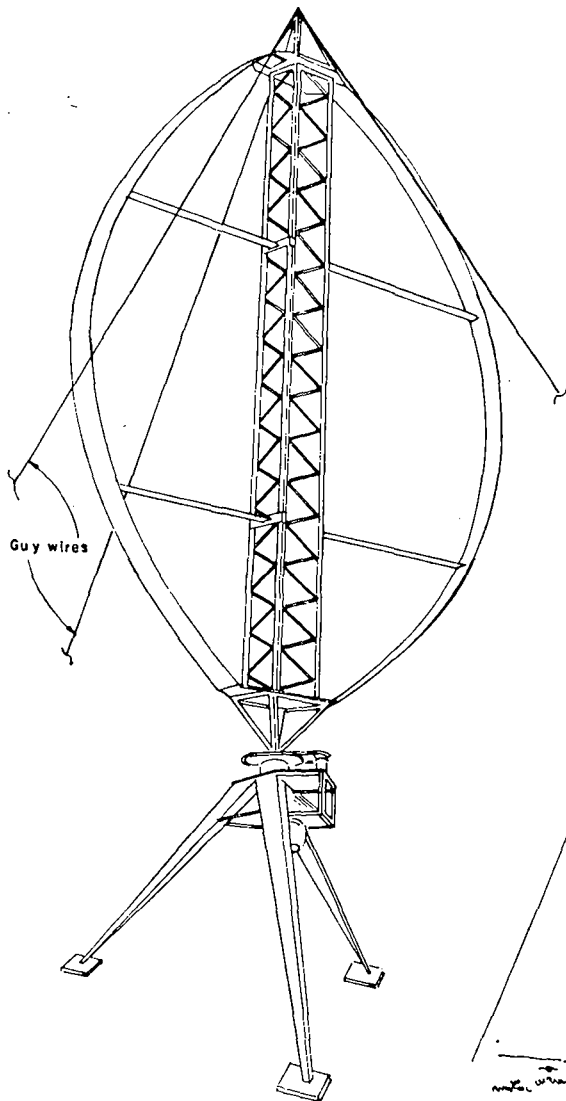

Figure 20. Darrieus rotor

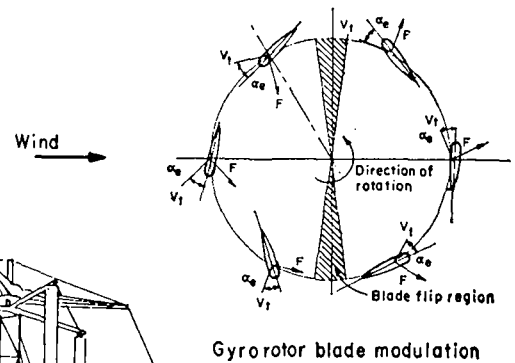
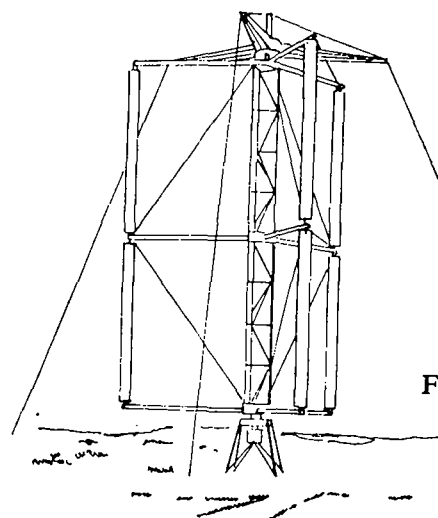

Figure 21. Gyro rotor



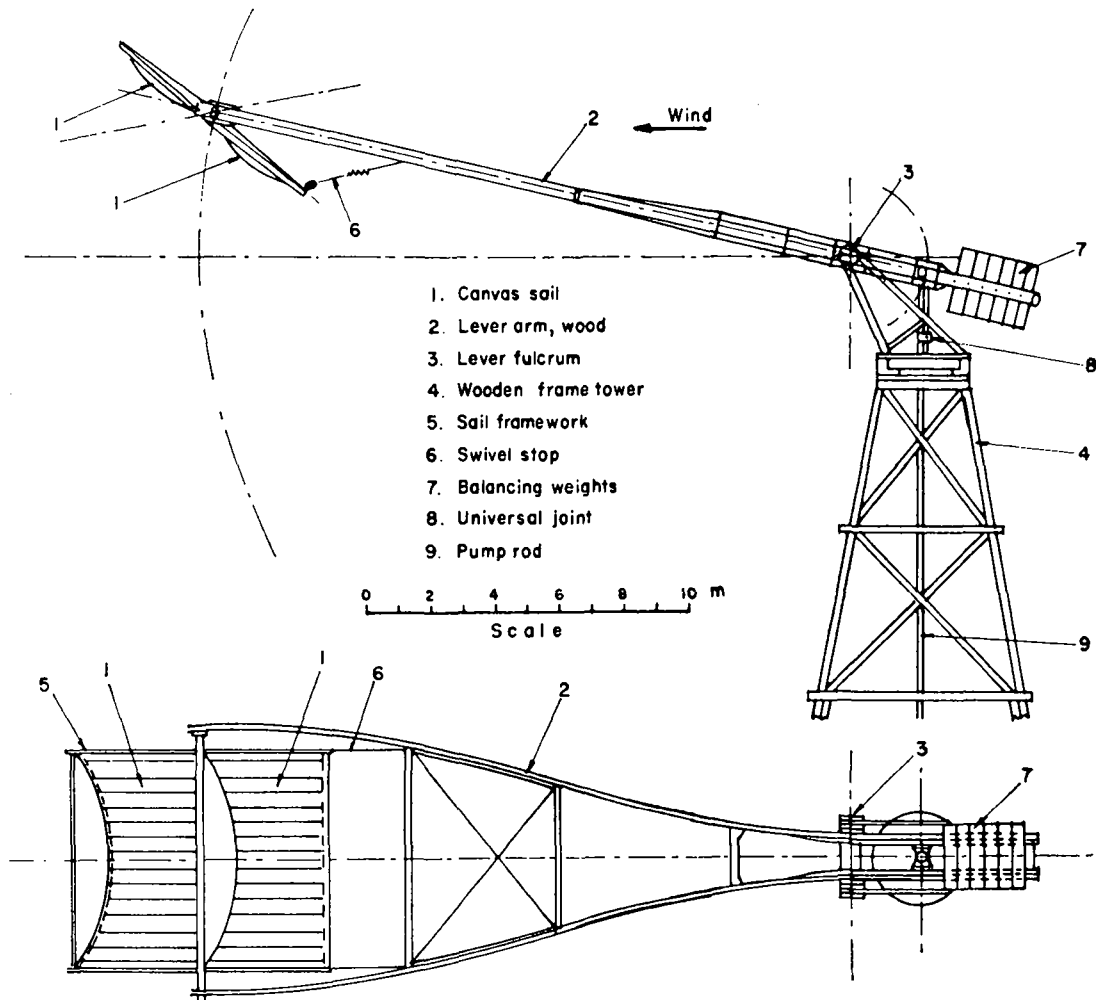

Figure 22. Flapping-vane rotor water pump

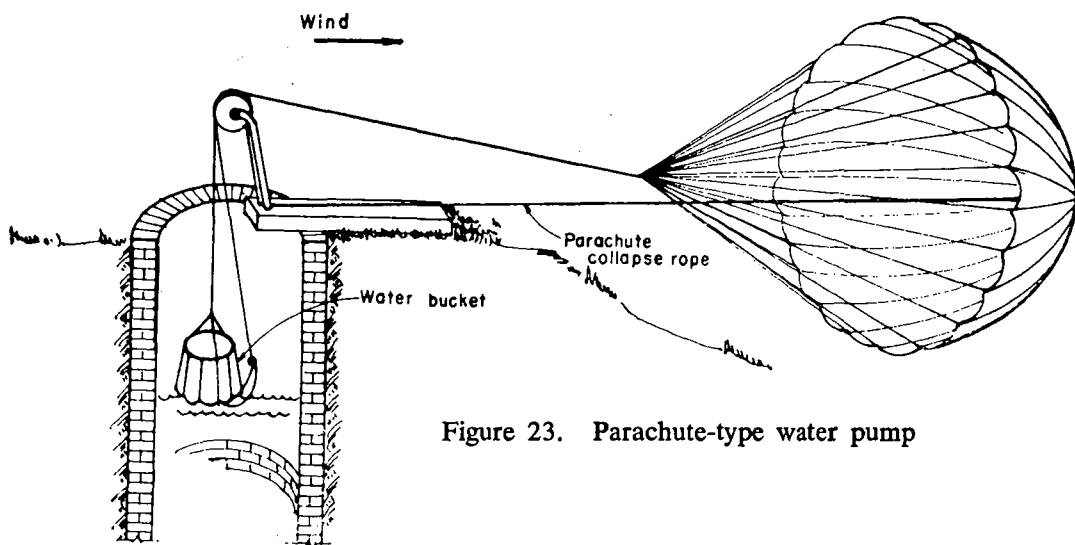

Figure 23. Parachute-type water pump

## 1. Reciprocating pumps

Most reciprocating pumps have the disadvantage that the torque load is not constant, thus requiring a higher wind velocity for starting, and variable stresses on the system when in operation.

(a) The single-acting cylindrical piston pump is most frequently used in wind-powered pumping systems. It consists of a cylinder with an inlet pipe and valve at the base, a leather-sealed piston with a one-way valve and a water outlet at the top, water passing through the pump only on the lifting stroke of the piston. This type of pump is used to pump water from any depth, with an operating speed of up to 40 strokes per minute.

(b) A square wooden single-acting piston pump is commonly used by fishermen in eastern Canada (figure 24) and has recently been adapted to wind power (reference W 46). A square wooden pump powered by the wind has been proposed for use in Thailand (reference W 47). The height of lift is limited by the amount of water pressure that can be sustained by the wooden joints, although the simple construction is well adapted to basic carpentering skills.

(c) The double-acting piston pump (figure 25) is similar to the single-acting pump, except that there is no valve or passage of water through the piston, the water by-passing the piston cylinder through pipes and valves under pressure during both the upstroke and the downstroke. The advantage of this pump over the single-acting pump is that the load on the power source is more constant, but it is not usually used in wind pumping systems because any compression load during the downstroke could buckle the long piston rod leading from the top of the tower: this problem could be avoided if a very short piston rod were connected to an immediately adjacent rotary power transfer mechanism powered by a long belt leading directly from the rotor shaft.

(d) The diaphragm pump (figure 26) consists of a cylinder closed at the lower end, with a circular diaphragm of rubber or some other flexible material fixed at the top end. A reciprocating connecting rod is fixed to the centre of the diaphragm and, upon vertical movement, causes volumetric displacement in the cylinder. An arrangement of valves allows water movement in only one direction through the cylinder. The difficulty with this type of pump is the high rate of wear on the diaphragm at its connexions with the cylinder and connecting rod. A diaphragm pump has been developed for use with a Savonius rotor (reference W 24).

(e) The inertia pump (figure 27 and reference W 48) is a very simple and efficient device that depends

upon the vertical inertia of a body of water in a reciprocating pipe to expel water at the end of the upstroke of the pipe. A one-way flap valve in the pipe is closed during the upstroke, and inertia is imparted to a fresh volume of water by the lifting force on the pipe. This pump must operate at a constant frequency which is dependent upon the mass of water in the pipe and the pipe itself. This recently popularized pump has probably not yet been used with wind power.

## 2. Rotary-motion pumps

Continuous rotary-motion pumps are well adapted to operation by wind power because they require a constant torque load and generally operate at a variable low speed.

(a) The square-wooden-pallet chain pump (figure 28 and reference W 49) is commonly used in China and southeast Asia for lifts up to 3 m and consists of rectangular wooden pallets or paddles mounted on a continuous wooden chain that runs up an inclined square-section open wooden trough. The paddles and chain pass around a large wooden driving gear wheel at the top and around a small passive gear wheel at the base of the trough which is submerged in water. This type of pump is commonly used with Chinese vertical-axis wind pumping systems and with Thai high-speed wooden rotors and Thai sail rotors.

(b) The round-steel-washer chain pump (figure 29 and references W 12, W 15) is used in conjunction with human and animal power, and consists of a continuous steel chain upon which are mounted steel discs with rubber or leather washers. The chain passes around an upper gear wheel, down the well, under the water source, around and then up into the bottom of a pipe with inner diameter the same as the washers. Water is lifted up within the pipe and expelled at the top. A square wooden adaptation of this pump is shown in figure 30.

(c) Large-diameter slow-speed centrifugal pumps (figure 31) have good potential for low-lift pumping. The meadow type wind pumps of the Netherlands are fitted with centrifugal pumps 1 m in diameter and 0.2 m high, with four wooden blades, and have an efficiency of 30 per cent and an output of up to 100 m<sup>3</sup> per hour in a strong wind. Further design development and quantification of design variables of these pumps could be undertaken.

Another type of centrifugal pump is the centrifugal reaction pump (figure 32) which consists of a vertical pipe with a T-joint at the top, from which extend two pipes whose length is dependent upon the rate of rotation of the assembly in operation. An orifice at the end of each pipe arm points 90° away from the arm. When the assembly is filled with water and

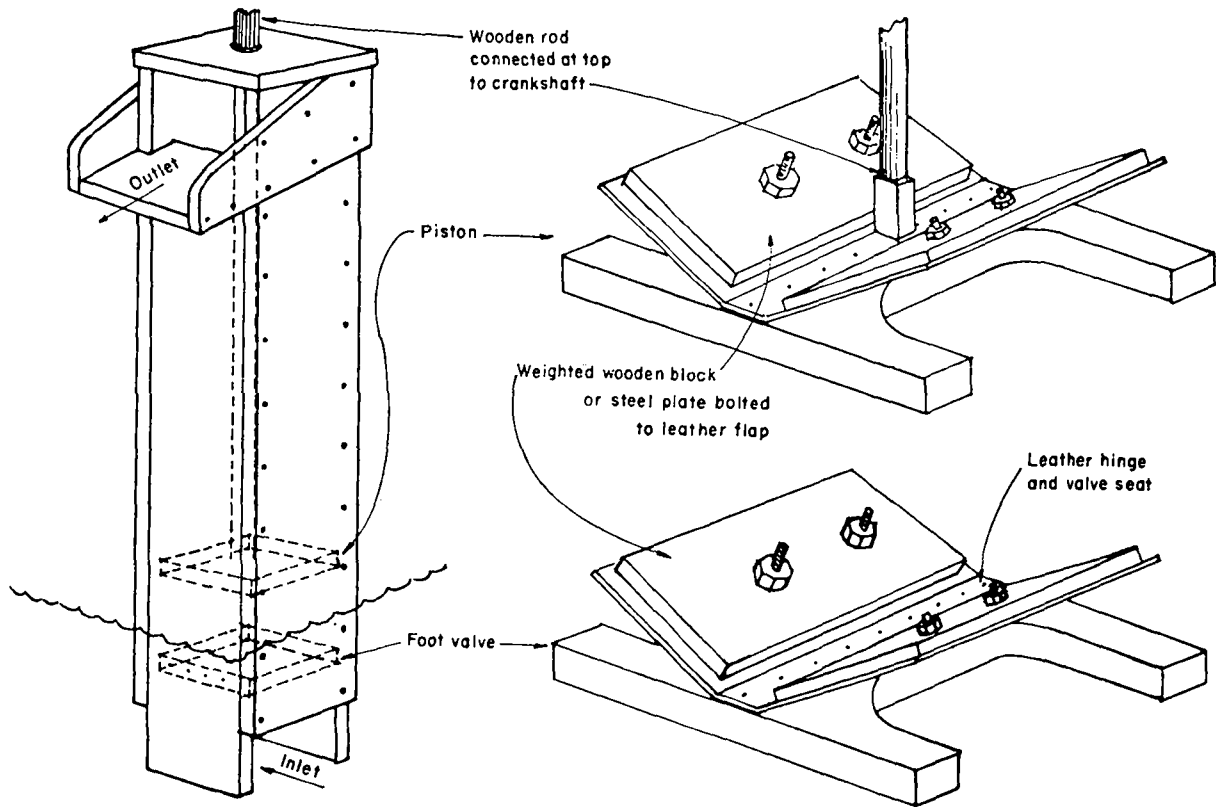

Figure 24. Square wooden piston-type water pump

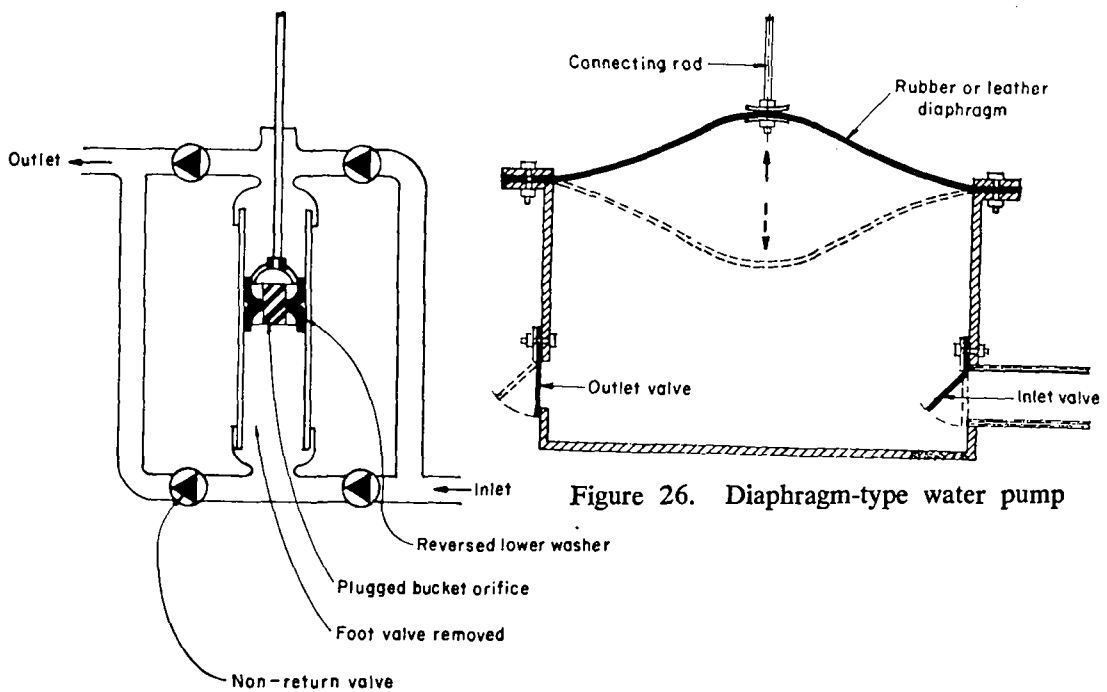

Figure 26. Diaphragm-type water pump

Figure 25. Double-acting piston-type water pump

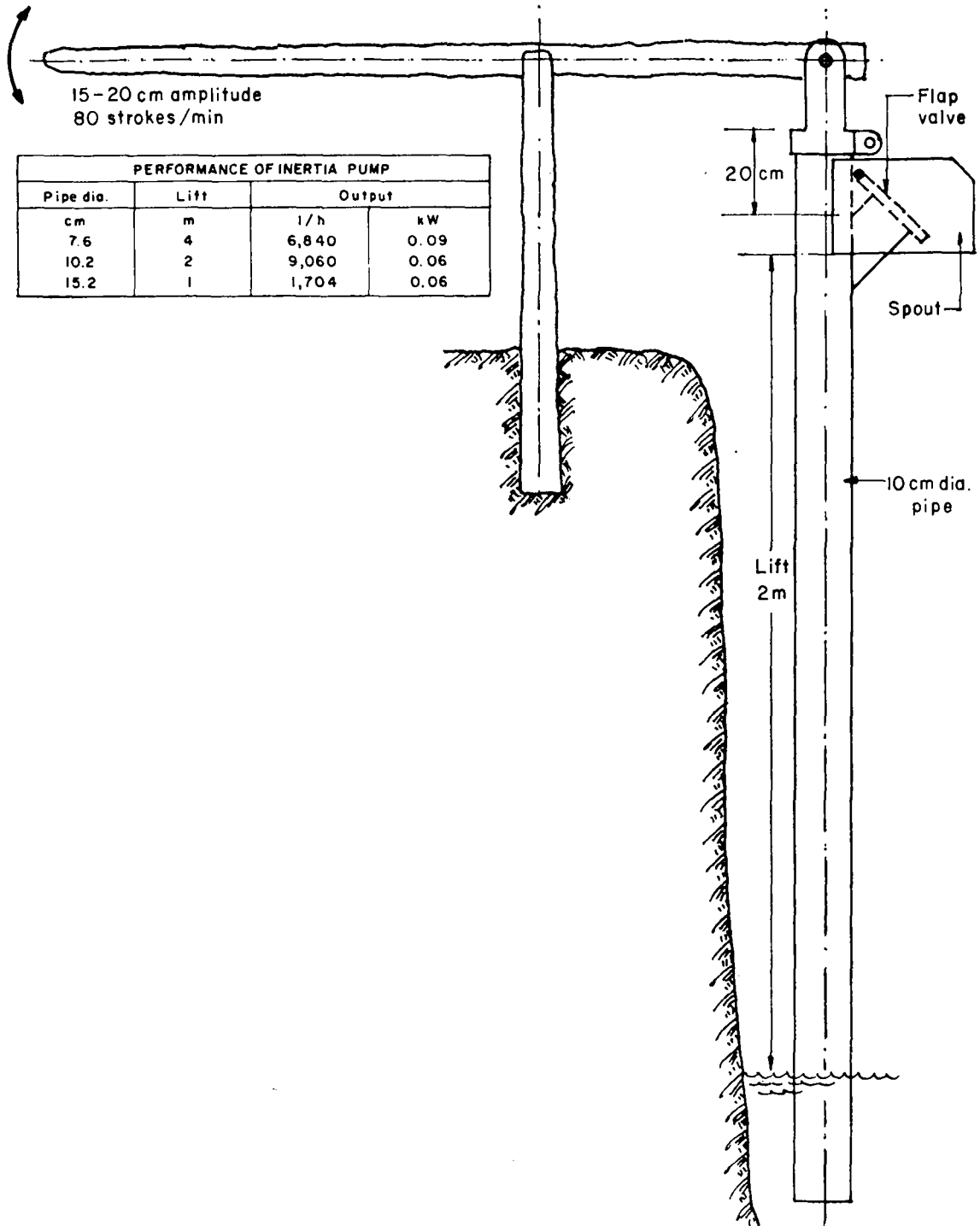

Figure 27. Inertia-type water pump

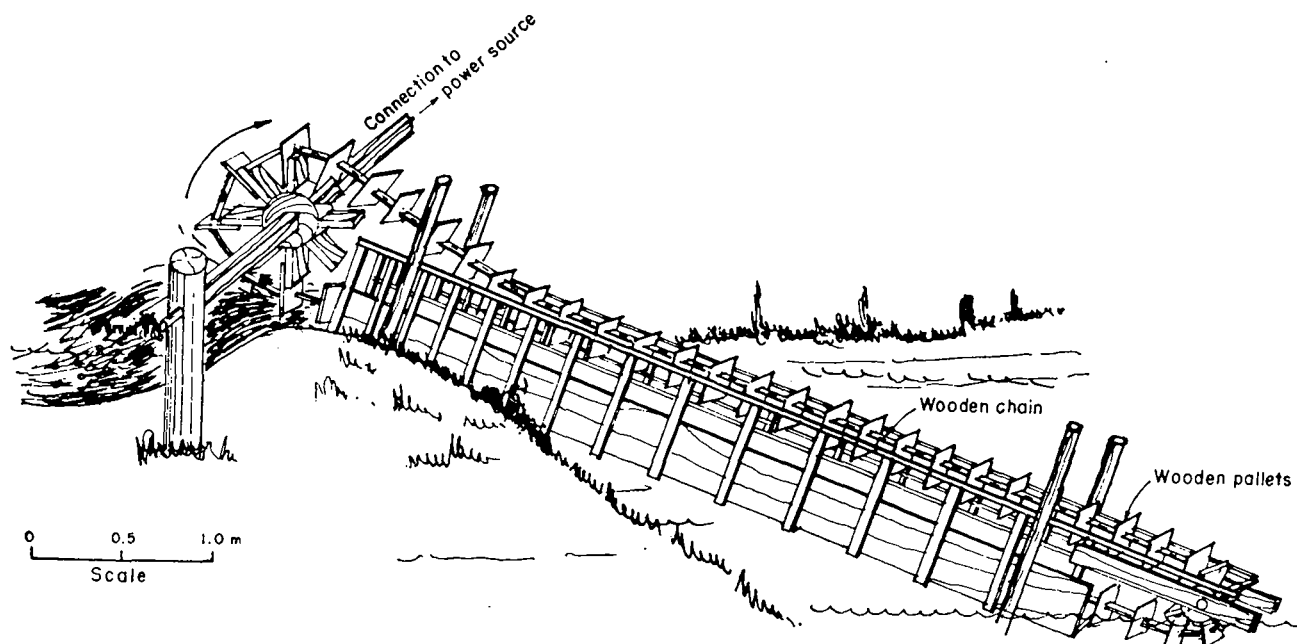

Figure 28. Wooden-pallet-type water pump

rotated in the direction opposite to the orifices, the water is forced out through the orifices by centrifugal force and replenished by water coming up through a valve in the bottom of the vertical pipe. This pump is well adapted to variable low speeds, and construction is simple. One of these pumps, connected to a 3-m diameter high-speed wind rotor, pumped 30 m<sup>3</sup> per hour at a head of 4.5 m in a 29-km/h wind (reference W 50).

(d) Axial-flow pumps have good potential for low-lift pumping because of their relatively simple construction and high efficiency. No use of these pumps with wind rotors is recorded, but it has been suggested that axial-flow pumps would be appropriate for high-volume pumping of sewage wastes in oxidation ponds (reference W 51). Theoretical studies of wind-powered axial-flow pumps are being carried out at the National Aeronautical Laboratory in India.

(e) Archimedean screws are very simple, and have efficiencies up to 80 per cent. They have been used in the Netherlands for large-scale drainage requiring a lift of up to 5 m. Three basic versions are known (reference W 48):

(i) The type with a rotating cylinder made of strips of wood and having a spiral partition inside (figure 33), as in the Tjasker type of wind pump in the Netherlands, requires a footstep bearing below the water level, and demands a fairly sophisticated level of construction skill. It can be made large in diameter and so suitable for slow-speed operation. Such a

screw, 2.7 m long, 0.56 m diameter and lifting through 1.3 m at a speed of about 30 rev/min, gives an output of 32.4 m<sup>3</sup> per hour.

(ii) The type in which the outer casing is stationary and the helical rotor is supported on bearings at either end, attached to the casing, are normally of smaller diameter and run at a high speed, e.g. 12-cm diameter up to 200 rev/min, 40-cm diameter up to 127 rev/min. An advantage of this type is that the casing and rotor form a self-contained assembly which does not require external bearings but only simple supports to maintain it at the correct angle and axial position. The screw is made by rolling a flat steel strip between rollers set at an inclination to each other to squeeze one edge of the strip and hence cause it to curl into a helix, which is then welded to an inner cylindrical pipe.

(iii) A third method of constructing an Archimedean screw is to coil a section of pipe into a cylindrical helix. A particular type has recently been evolved for field drainage in which the tubing is corrugated with a fine pitch to strengthen it and to allow coiling to a small radius. This could form the basis of a simple low-cost pump, since most of the construction could be done locally. For example, a stout bamboo could serve as the main axle, and the coils of pipe could be held in place by lashing with rope, wire or any suitable local fibre, using longitudinal strips of bamboo or other wood to form a supporting cage on the inside of the coils.



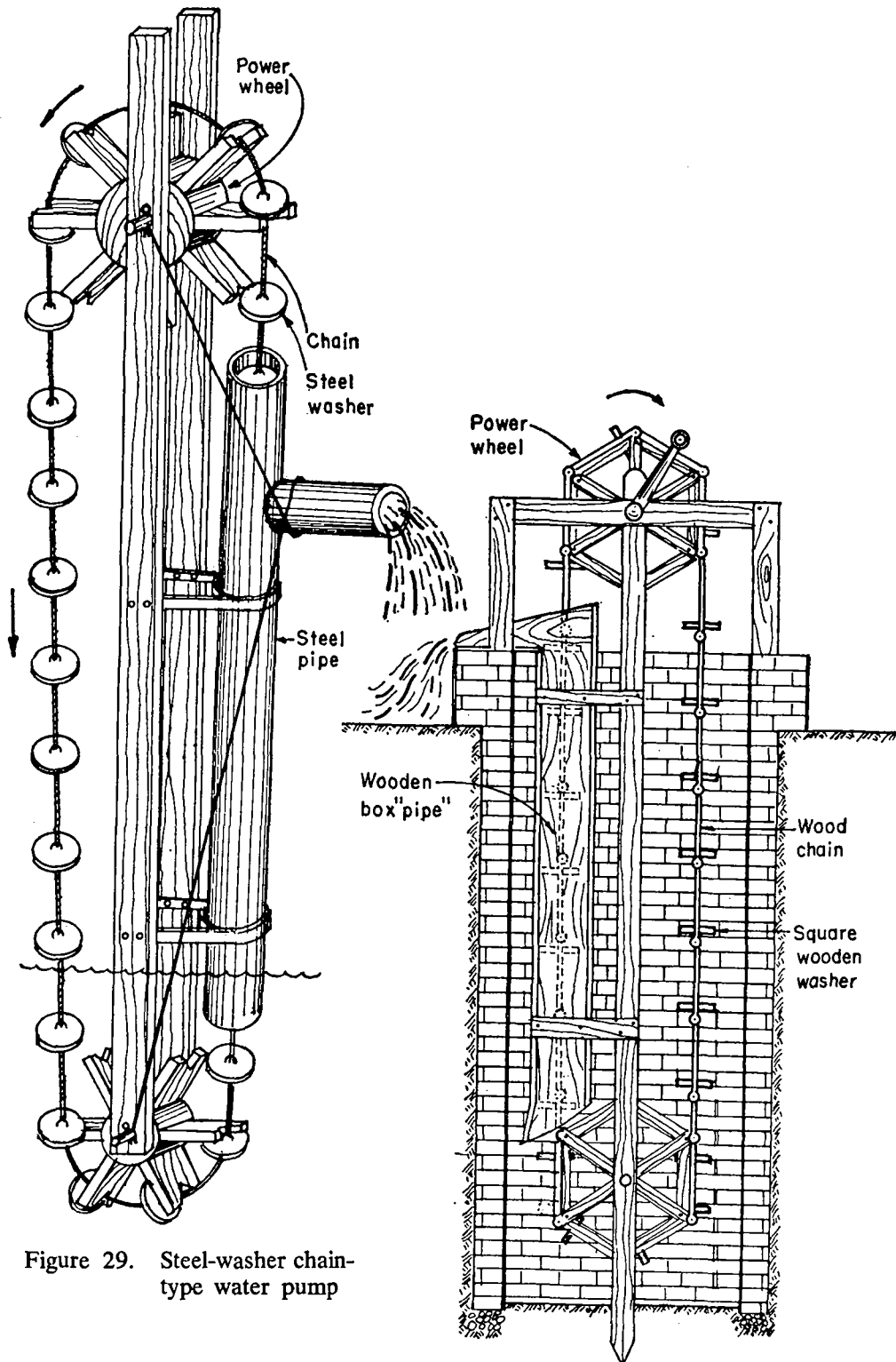

Figure 29. Steel-washer chain-type water pump

Figure 30. Square wooden enclosed chain-type water pump

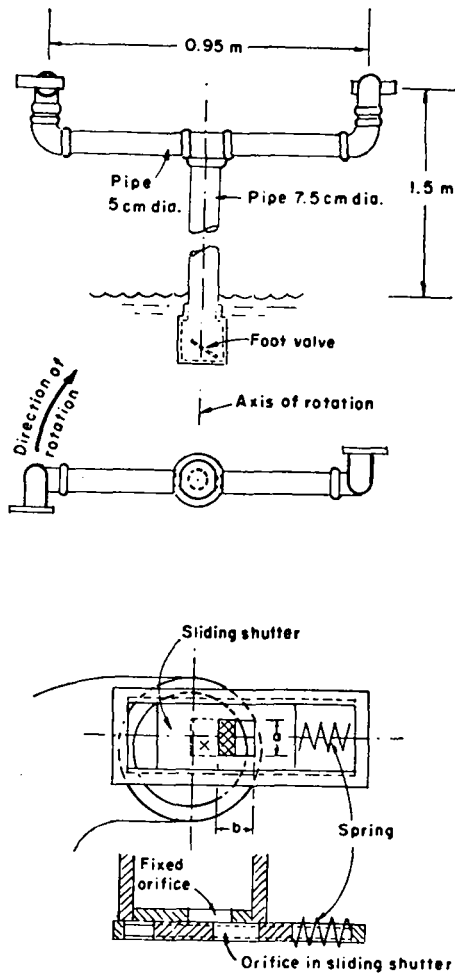

Figure 32.  
Centrifugal reaction-type water pump

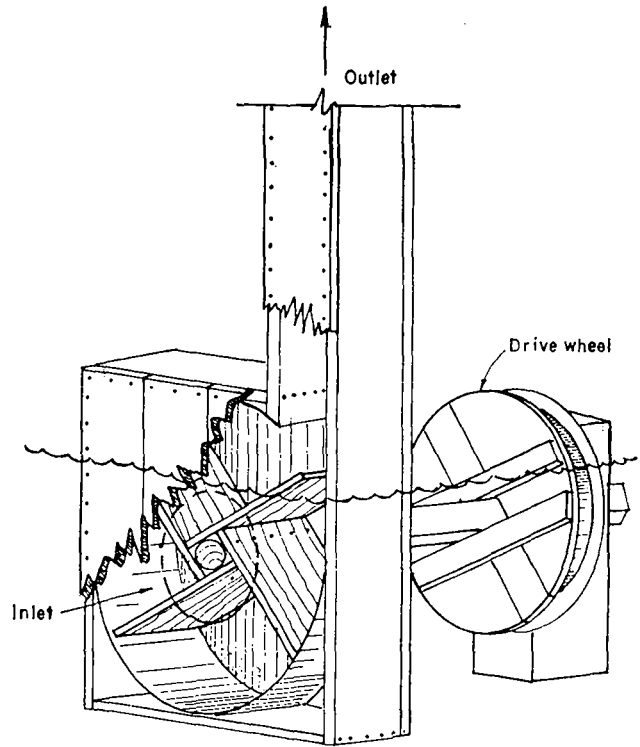

Figure 31.  
Large-diameter slow-speed centrifugal-type water pump

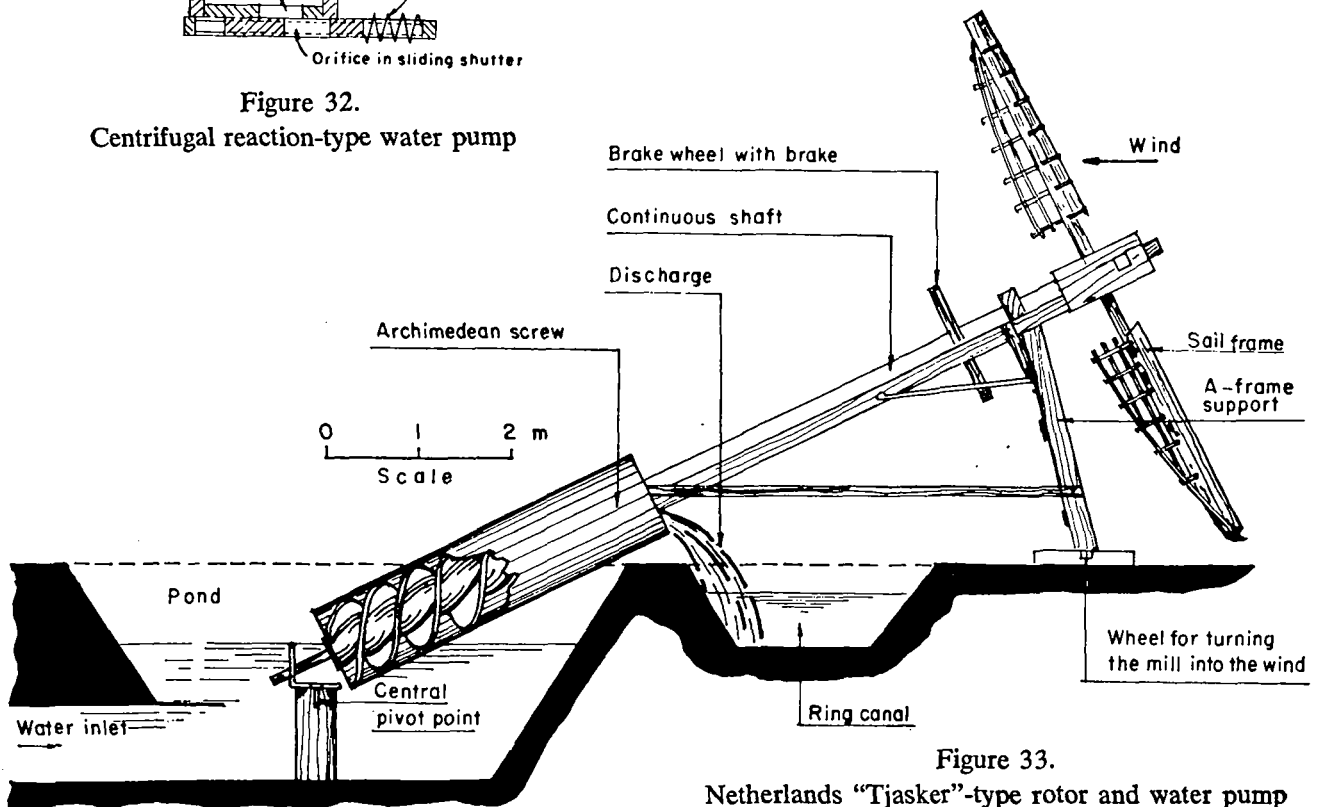

Figure 33.  
Netherlands "Tjasker"-type rotor and water pump

(f) The peristaltic pump (figure 34) consists of a flexible hose with a series of rollers rolled along the length of the hose in order to squeeze water through the hose. This type of pump has reportedly been adapted to a Greek sail wind rotor at the Malaysian Agricultural Research and Development Institute.

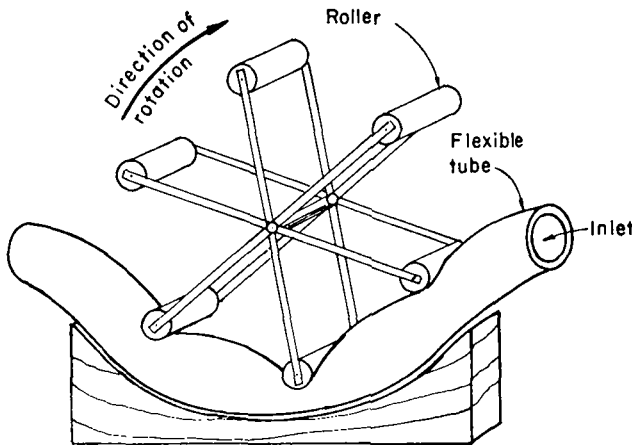

Figure 34. Peristaltic-type water pump

(g) A simple water pump operated by compressed air (figure 35 and reference W 46) is currently being tested. The advantages of this pump are that it can be located some distance from the compressor, two or more pumps could be operated by one compressor, or one large pump could be operated by two or more smaller compressors.

(h) A hydraulically operated water pump (figure 36) is currently under development by the Ministry of Lands, Settlement and Water Development in Tanzania. This pump was designed to solve the problems of using piston pumps in very deep and narrow borehole wells.

### III. DATA ANALYSIS AND CRITICAL DECISIONS

#### A. DETERMINATION OF RATED WIND VELOCITY AND WATER DEMAND

For the months of greatest water pumping demand, graphs such as those in figures 3 and 4 should be prepared on a monthly basis. If continuity of water supply is important, the rated wind velocity chosen would be somewhat lower than if maximum output were the only goal. Daily water demand should be summarized on a monthly basis.

#### B. SELECTION OF ROTOR

The selection of the type of rotor requires careful consideration of local skills and materials as well as operating and performance characteristics, bearing in

mind that the precise characteristics of the main types of low-cost locally-constructed rotors are not readily available. A reasonable compromise must be made between high reliability, durability and maintenance-free operation on the one hand, and low construction cost on the other hand, taking into account that increased labour input will generally result in lower capital input.

Selection of a rotor is also dependent upon the type of pump to be used. To maximize the efficiency of power transfer, the torque, speed and power characteristics of the rotor and pump should be as similar as possible.

#### C. SELECTION OF PUMP

Selection of the type of pump depends on the total pumping head, the type of rotor and the local materials and skills available for construction. The use of traditional local pumps, whenever possible, will reduce the problems of introducing a new technology.

#### D. DETERMINATION OF DESIRED PUMP OUTPUT

The starting, rated and maximum operating wind velocities of the rotor must be known to determine the load factor (figure 4). Division of the daily water demand by the load factor will yield the desired rated output of the pump. If this rate is greater than the maximum output of the type of pump selected, the need for a pump with greater output or the use of more than one pump is indicated if the total demand is to be met.

#### E. DETERMINATION OF THE RATED POWER REQUIREMENT OF THE PUMP

The rated power requirement of the pump may be obtained from the following relation:

$$\text{Power (kW)} = \frac{\text{Desired output in m}^3/\text{sec} \times \text{head in m} \times 9.8}{\text{Pump efficiency in per unit}}$$

#### F. DETERMINATION OF THE NEED FOR AN ORIENTATION MECHANISM

The need for an orientation mechanism may be determined by analysing the frequency of each wind direction as in figure 5. In many tropical, and especially coastal, areas, the wind blows mainly in either of two opposite directions. In such cases, the use of a fixed-axis rotor can save considerable construction expense. If an orientation mechanism is required, the choice of manual or automatic orientation will depend on the number of changes in wind direction.

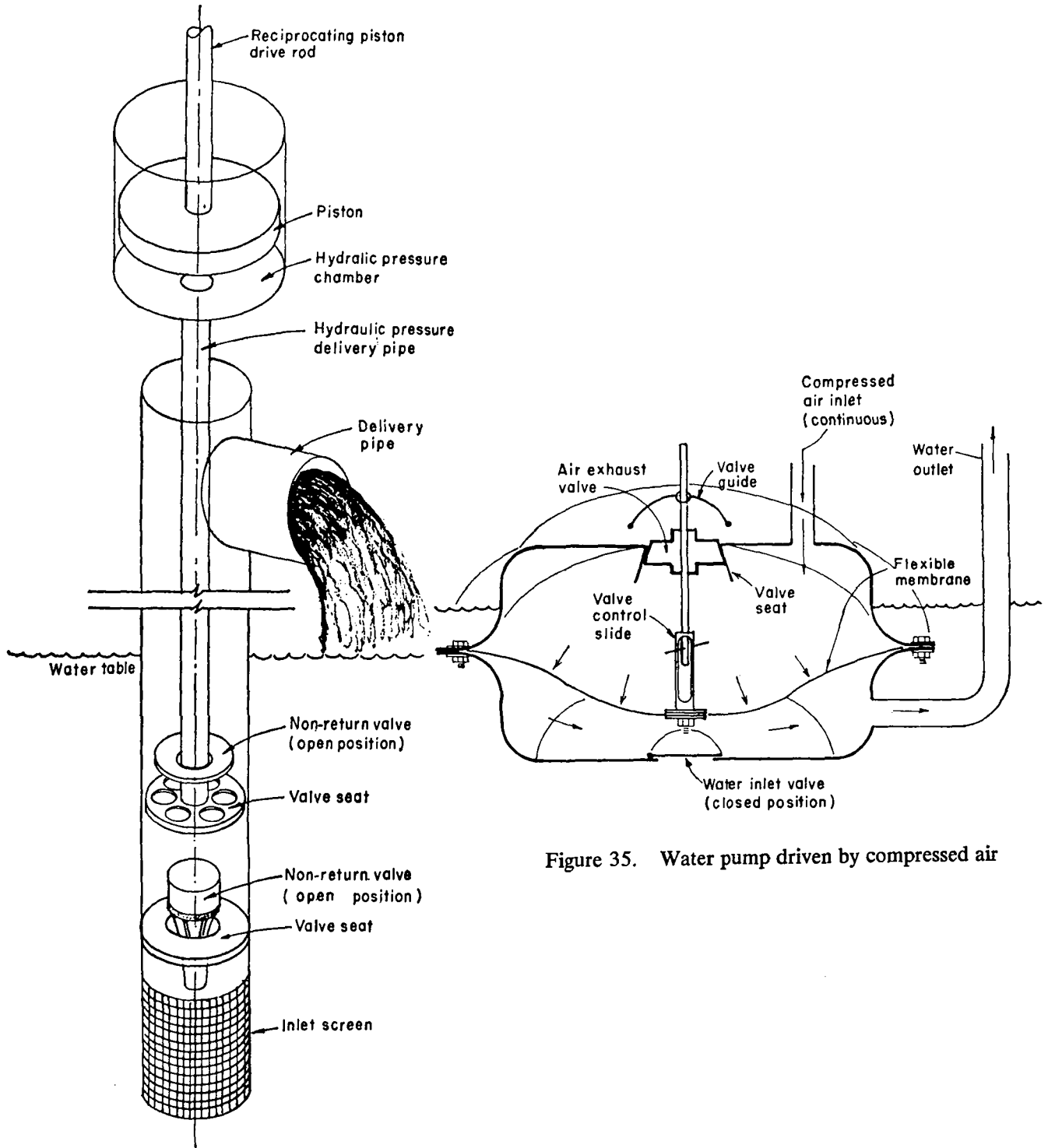

Figure 36. Hydraulic-drive water pump

Figure 35. Water pump driven by compressed air

#### IV. COMPONENT DESIGN AND MATCHING

##### A. CONTROL MECHANISMS

Mechanisms to stop the rotor and to control rotor-blade pitch angle, blade area and pump stroke should be incorporated in the design in order to allow operation under a maximum range of wind velocities, without damage. The pitch angle of rigid blades may be controlled by centrifugal governors or blade coning. The pitch angle of non-rigid sails may be controlled by manual or spring adjustment of the trailing edge tension. The area of sails may be controlled by furling. Pump stroke may be adjusted by changing the fulcrum point of a lever.

##### B. ROTOR RADIUS

The required radius of the rotor in metres depends on the power output required in kW, the rated wind velocity in km/h, and the rotor and power transfer efficiency according to the relation:

$$\text{Power} = 0.0000255 R^2 v^3 (\text{eff}_r \times \text{eff}_t)$$

where:  $\text{eff}_r$  = efficiency of rotor in per unit

$\text{eff}_t$  = efficiency of power transfer in per unit

The maximum size of the rotor may be limited by the maximum length of spar material available or by the type of tower materials.

##### C. PUMP SIZE

The size of the pump is a direct function of the desired rated output, speed of operation and efficiency. Materials or power available will usually determine the maximum pump size.

##### D. POWER TRANSFER MECHANISM

The function of the power transfer mechanism is to transfer the rotary motion of the rotor to the pump, and the design depends upon the type of pump used (reciprocating or rotary motion) and the type of rotor (horizontal- or vertical-axis).

For rotary pumps, differences in speed between rotor and pump up to a ratio of 4:1 can be compensated for by a single-step pulley or a gear transfer. Rotary motion of a horizontal shaft can be converted to vertical rotary motion by gears and transferred to ground level by a rotating power shaft, or horizontal rotary motion at ground level can be obtained by the use of large diameter upper and lower pulleys and a steel chain or cowhide belt.

Vertical reciprocating motion is usually obtained from a crankshaft, and passed down through the centre of the turntable to the pump by a steel or wooden connecting rod which incorporates a swivel to prevent the

rod from being twisted when the carriage assembly and rotor shaft turn in response to change in wind direction. It is desirable to keep the stroke of a crankshaft as small as possible in order to minimize turntable diameter but, with commonly available piston pumps, it is desirable to make the stroke as long as possible. This apparent conflict can be resolved by using a lever arm as shown in figure 8.

##### E. ORIENTATION MECHANISM

The orientation mechanism can take the form of a classic tail vane for automatic orientation or, where changes in wind direction are not frequent, a manually-operated tail rope as in Thai wooden-blade windmills, (figure 15) or manually-shifted A-frame axis supports as in the Netherlands Tjasker type (figure 33) and Chinese diagonal-axis type (figure 37).

The function of the turntable is to allow the rotor, main shaft and carriage assembly to rotate only about a fixed point in a horizontal plane on top of the fixed tower and to prevent any vertical or horizontal movement. Vertical power transfer usually passes through the centre of the turntable, but a considerable saving in turntable construction cost may be achieved by having the power transfer outside the turntable.

Multi-blade wind pumps incorporate a ball-bearing turntable, but a simple greased circular steel ring has proved adequate for Greek type wind pumps. The Thai wooden-rotor wind pump (figure 15) uses a tapered wooden post inserted into a wooden hole in the carriage assembly, with the power going down outside the post.

##### F. HUB, MAIN SHAFT, BEARINGS

The selection of hub, main shaft and bearings is most important because rotor load stresses are concentrated on these components.

The function of the hub is to connect the root end of the rotor spars firmly to the main shaft. The hub must withstand the centrifugal force of the rotor, and bending loads of the rotor spar caused by wind pressure and rotor torque. These forces (indicated in figure 38) are quantified in the following formulae:

$$\text{Centrifugal force (kg)} = 0.00219 \frac{W t_1^2 v^2}{R_1}$$

$$\text{Torque (m - kg)} = 367 \frac{RP}{tv}$$

$$\text{Wind pressure (kg)} = 0.00142 v^2 R^2$$

for a spinning rotor, and is increased by twice the solidity factor for a stationary rotor

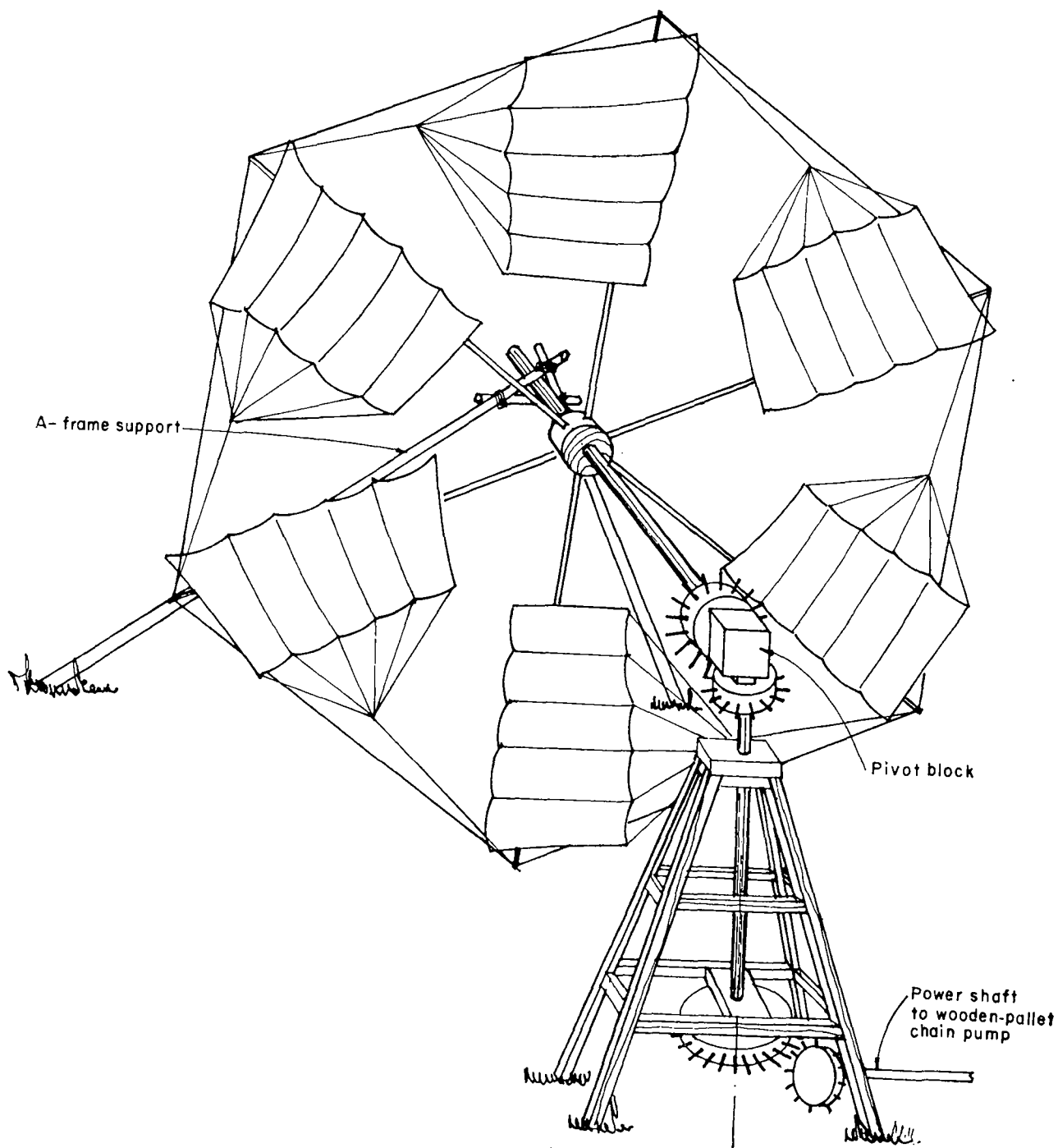

Figure 37. Chinese diagonal-axis rotor water pump

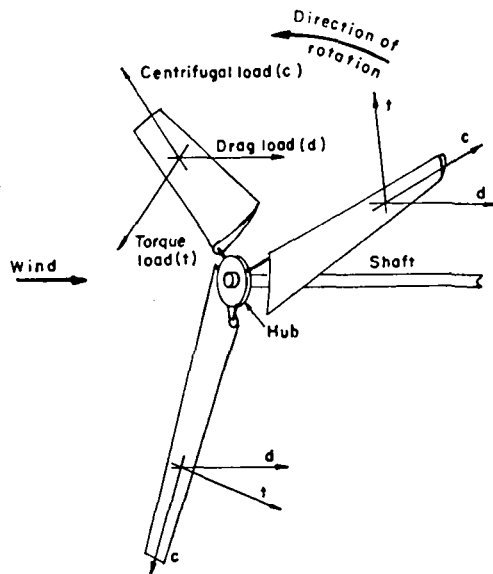

Figure 38. Loads on rotor

- where:  $P$  = power in kW  
 $R$  = radius of rotor blade in m  
 $R_1$  = radius to centre of gravity of rotor blade in m  
 $t$  = tip speed ratio at tip  
 $t_1$  = tip speed ratio at centre of gravity of rotor blade  
 $v$  = wind velocity in km/h  
 $W$  = weight of the blade in kg

The main shaft must bear the weight of the rotor and withstand the torque and bending forces applied by the power transfer mechanism. The shaft may be made from wood, steel rod or steel pipe.

Simple wooden bearings or steel ball or thrust bearings may be used. If steel bearings are used, adequate protection must be provided against dust and rain. Wooden bearings should be capable of easy replacement. Provision must be made for lubrication.

### G. TOWER

Determination of the type of tower is primarily a function of the materials and skills available. The Windworks octahedron module design (figure 10) has the highest strength-to-weight ratio of any non-guyed tower, but construction is complex and must be precise. Lattice steel towers (figure 6) are strong and well proven but quite expensive. Single wooden pole towers (figures 7 and 15) are the cheapest, but can only be used when it is not necessary to have the power transfer down the centre of the tower. Multiple wood pole towers (figure 8) are cheap, strong and easy to construct, and use is limited primarily by resistance to wood ants and termites. The use of guy

wires, when possible, will significantly increase over-all tower strength at little cost.

The minimum tower height should be at least equal to the rotor radius plus 1.8 m (for safety of personnel). Efforts to make the tower much higher than this should be avoided because the additional cost is likely to be greater than the increase in benefit, except in locations with nearby wind obstructions.

### H. CARRIAGE ASSEMBLY

The carriage assembly provides a firm but movable foundation for the main shaft bearings upon the tower, and may be of wood or steel. It must be fastened to the turntable in such a way that it may turn in response to changing wind direction. The tail is fastened to the carriage assembly.

### I. STORAGE TANK

The maximum capacity of the storage tank is determined by multiplying the longest period of wind less than starting velocity by the daily water demand. Overhead storage is not economical unless pressurized supply is required. A ground-level tank may be constructed of stone masonry about 1 m high. Possible additional uses of the storage tank for bathing and fish culture should be taken into consideration.

### J. WORKING DRAWINGS, MODEL

After preliminary sketches of each component have been prepared, the final working drawings should be made, showing the details of and connexions between each component.

A 1/5 scale model should be made and tested in order to gain familiarity with the construction process and to carry out design optimization trials. Only after a model has been tested to full satisfaction should construction of a full-scale prototype proceed.

## V. A HYBRID ASIAN WIND-POWERED WATER PUMP

In this section, an example is given of the design of a low-cost wind-powered water pump according to the sequential flow design process suggested in figure 1. An effort has been made to base the design on conditions common to many parts of Asia.

### A. PRELIMINARY INVESTIGATION

#### 1. Survey of local wind characteristics

The average wind velocity at Don Muang Airport, Bangkok, for 5 minutes of each half hour is recorded by the Meteorological Department of Thailand. As noted, the data for the months of March, April, May 1975 had been summarized and analysed as shown in figures 2, 3 and 4. Data from the airport were selected because of its exposed location in a rice-growing area

and its proximity to the Asian Institute of Technology and the proposed National Energy Administration windmill test location.

## 2. Survey of local water pumping needs

March, April and May were chosen as the period when irrigation pumping would be most beneficial because the first crop of rice is already harvested by February and, in the virtual absence of rain, the fields are normally not used until the onset of the monsoon in June.

## 3. Classification of wind rotors and pumps

As a complete classification of wind rotors and pumps is not available, reference will be made to previous sections of this report.

## B. DATA ANALYSIS AND CRITICAL DECISIONS

### 1. Wind data analysis

(a) Consideration of the velocity and power frequency curves (figure 3) indicates an optimum

starting velocity of 6 km/h and an optimum rated velocity of 20 km/h in order to obtain maximum output.

(b) The raw wind data indicate that the longest period of wind below optimum starting velocity of 6 km/h is 6 hours.

(c) Study of the wind power rose (figure 5) indicates that an orientation mechanism would be useful but not necessary; but, for the benefit of other areas with more variable wind direction, it is assumed that there is a need for an orientation mechanism.

(d) Analysis of the power duration curve (figure 4) yields a load factor of 0.30.

### 2. Selection of rotor

Based on the widespread success, low cost and light weight of the Greek sail rotor, this configuration was selected (figure 39). An alternative configuration that may be used in areas of higher wind speeds is based on the Princeton sail wing (figure 40).

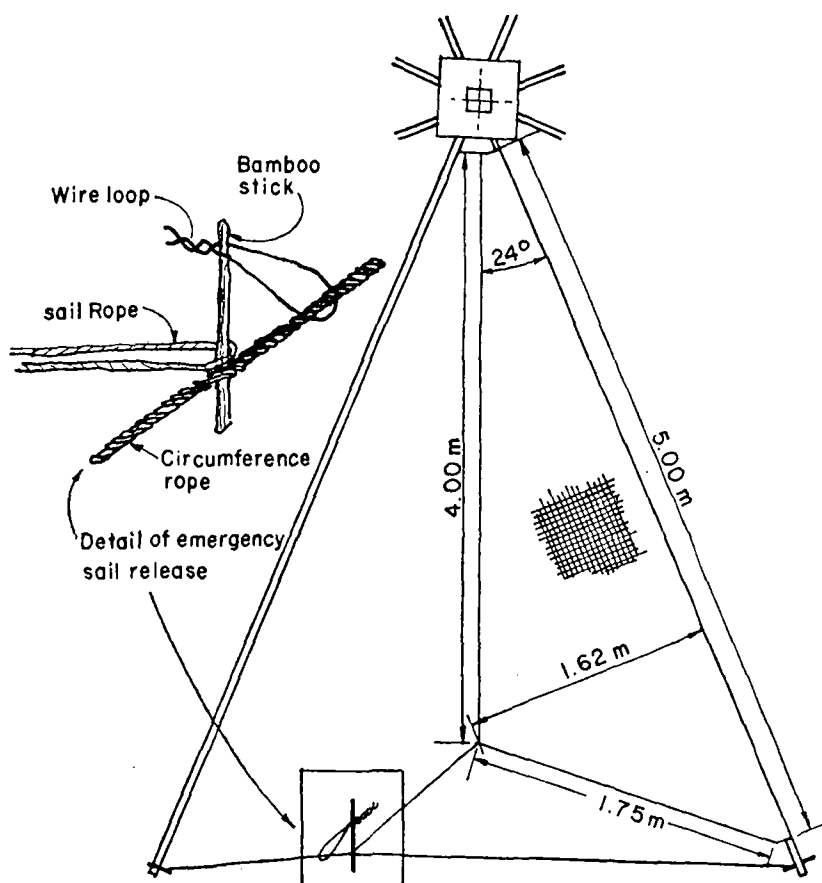

Figure 39. Greek cloth sail rotor configuration



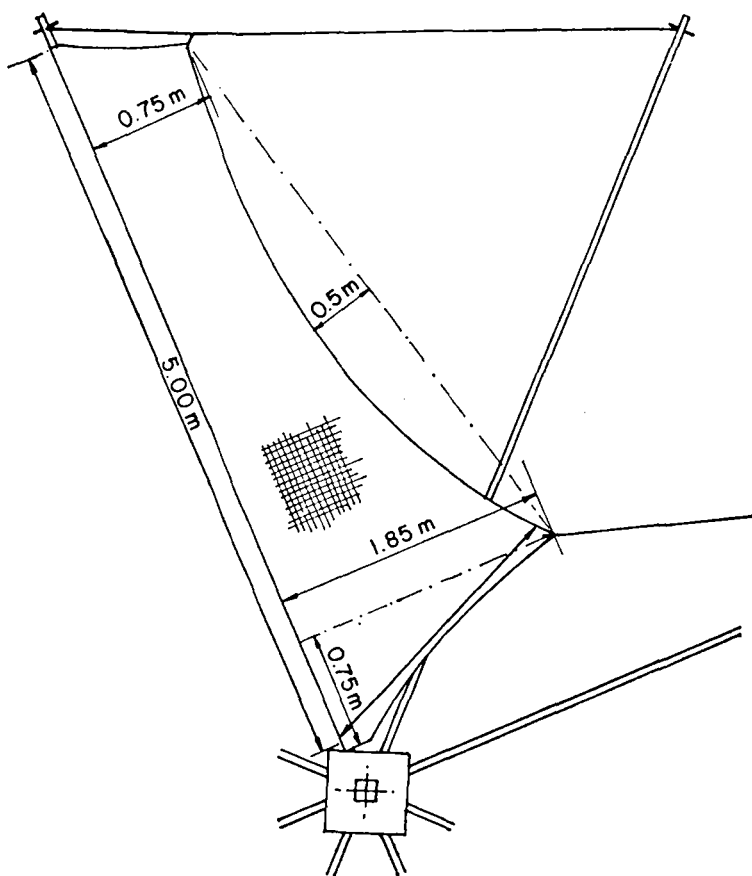

Figure 40.

Hybrid Princeton — Greek sail rotor configuration

### 3. Selection of pump

For generalized design purposes, a total head of 10 m is assumed. Owing to its simplicity of construction and adaptability to variable low-speed rotary motion, the steel-washer chain pump was selected (figure 29). However, the square-pallet chain pump (figure 28) may be best for areas where this pump is traditionally used and only a low lift is required.

### 4. Determination of desired pumping rate

Assuming a daily requirement of 6.5-mm depth per day for rice cultivation and a desired irrigated area of 2 hectares, the daily water demand is 130 m<sup>3</sup> per day. Multiplication by the reciprocal of the load factor indicates that the rated capacity of the pump should be 18 m<sup>3</sup> per hour.

### 5. Determination of rated power requirement of the pump

Assuming 0.70 pump efficiency, the rated power requirement of the pump would be 0.703 kW (section III. E).

## C. COMPONENT DESIGN AND MATCHING

### 1. Control mechanism

Assuming frequent presence of the operator, furling of the sails would be the primary control mechanism. An emergency sail-release mechanism similar to that used on Thai sail rotors would be incorporated (figure 39).

### 2. Size of rotor

Assuming 0.25 and 0.50 for the efficiencies of the rotor and power transfer respectively, the required rotor diameter from section IV. B would be 10.5 m.

This size is within the range of bamboo spars available in Thailand and most Asian places. Sail rotors have been operated successfully up to 10-m diameter so this size is acceptable.

### 3. Size of pump

Given the rated output of 18 m<sup>3</sup> per hour and pump efficiency 0.70, the basis of calculation is 25.7 m<sup>3</sup> per hour. Assuming a rated rotor speed of 12 rev/min

with a 2:1 speed increase and a 0.5-m diameter pump drive wheel, the size of the pipe within which water is lifted by the washers on the chain should be 12.0 cm. The size of the pipe may be decreased by increasing the speed of the chain, which may be effected by providing a higher drive speed ratio or by increasing the diameter of the pump drive wheel. The optimum speed of chain pumps is not known.

#### 4. Orientation mechanism

Orientation of the main shaft by manual relocation of an A-frame support structure (figure 41) supporting one end of an extended shaft is suggested because of its simplicity and proven feasibility on the Netherlands Tjasker type (figure 33) and Chinese diagonal-axis type (figure 37). The opposite end of the shaft rotates about a fixed, guyed turntable post (figure 42).

#### 5. Power transfer mechanism

Because horizontal rotary motion is required to operate the chain pump, only a simple direct pulley drive to ground level is required. Pulley wheels made of several laminations of wood boards are suggested (figure 42). Chains are widely used in Thailand as the transfer connexion and would be suitable.

#### 6. Hub, main shaft and bearings

(a) A laminated wooden hub was selected (figure 43) because of its simplicity of construction and successful use on Thai sail rotors.

(b) An extended square wooden main shaft is successfully used on Thai sail rotors and has been selected for this hybrid design (figure 43). The shaft is rounded only at the point where it rests in the bearing (figures 41, 42).

(c) Simple wooden bearings have been well proven on Greek and Thai sail rotors and Australian Comet wind-powered pumps. An improved version of Greek wood bearings with increased bearing surface and provision for lubrication has been designed for both main bearings (figures 41, 42).

#### 7. Tower

The tower in this case consists only of the two legs of the movable A-frame at one end of the shaft and the turntable post at the other end. The turntable post is guyed to the ground and the A-frame is guyed to the base of the turntable post so that it is stabilized but still free to move.

#### 8. Carriage assembly

The large wooden bearing blocks also function as the carriage assembly.

#### 9. Storage tank

Because the longest period of wind below starting velocity is only six hours, a storage tank is not considered necessary, although it would be useful for irrigation control.

#### 10. Final drawings

An over-all sketch of this hybrid design (figure 44) is proposed as the basis for construction of models for testing only. For further development of this design, model test results should be evaluated and design modifications incorporated into final working drawings for prototype construction and testing.

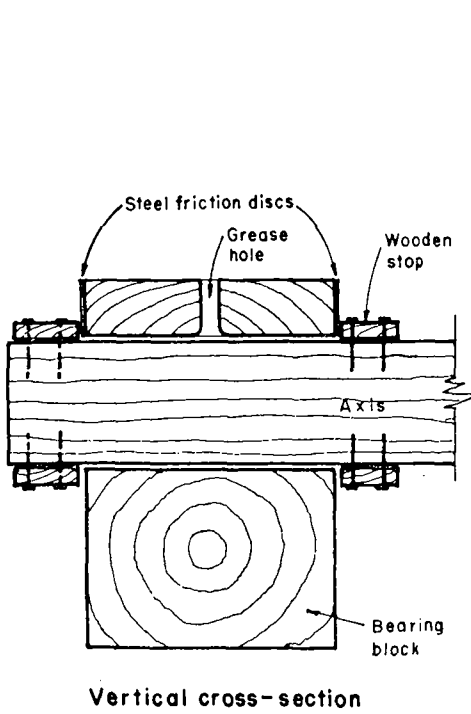
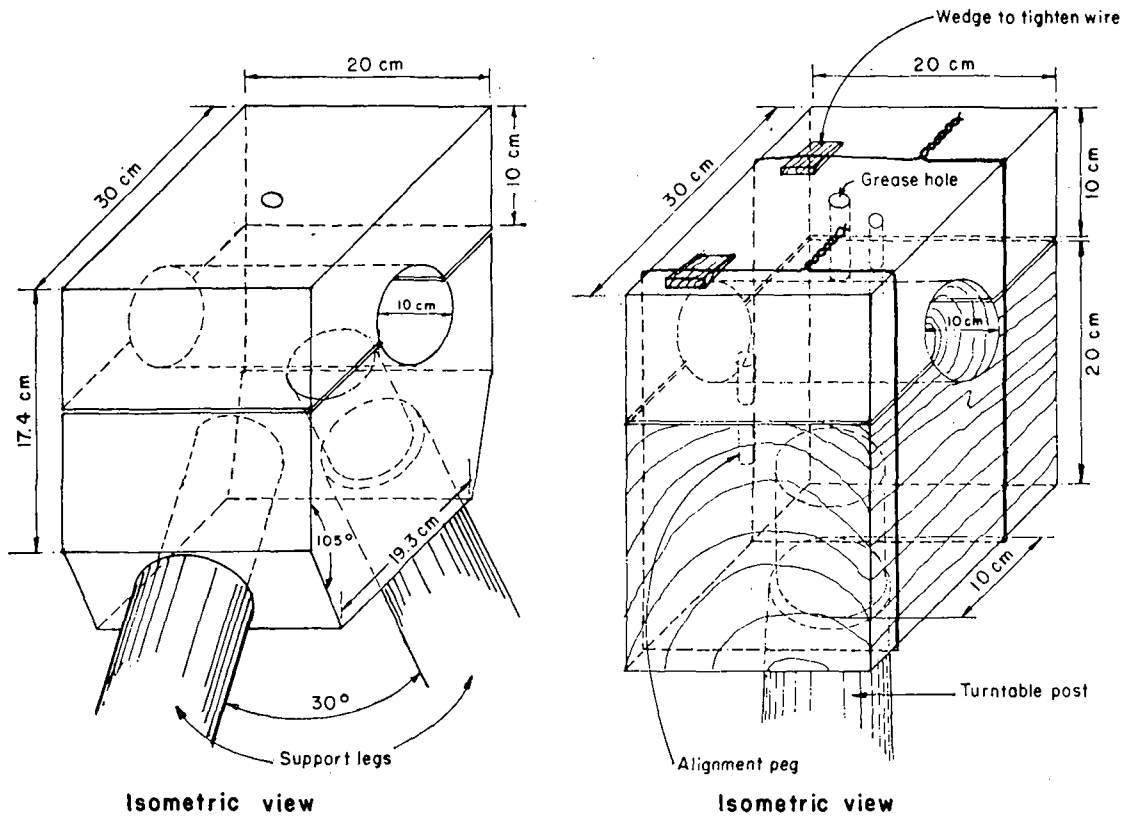

Figure 41. Double leg support bearing block

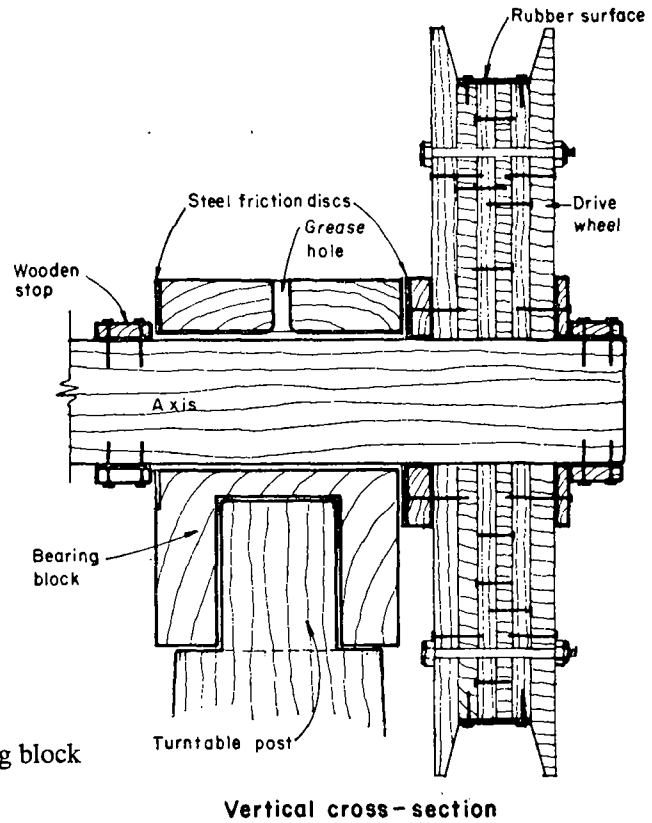

Figure 42. Turntable post bearing block

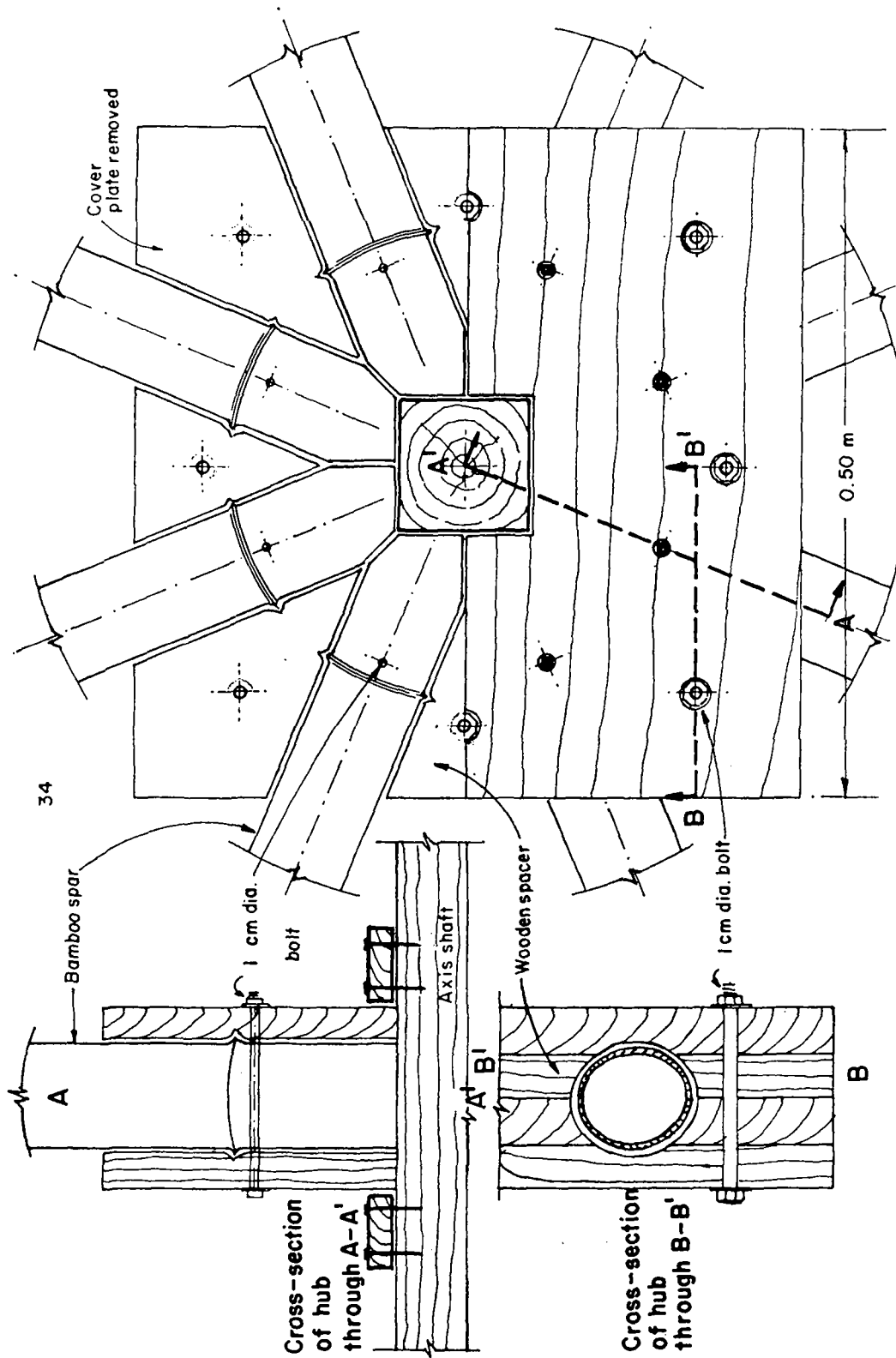

Figure 43. Details of hub

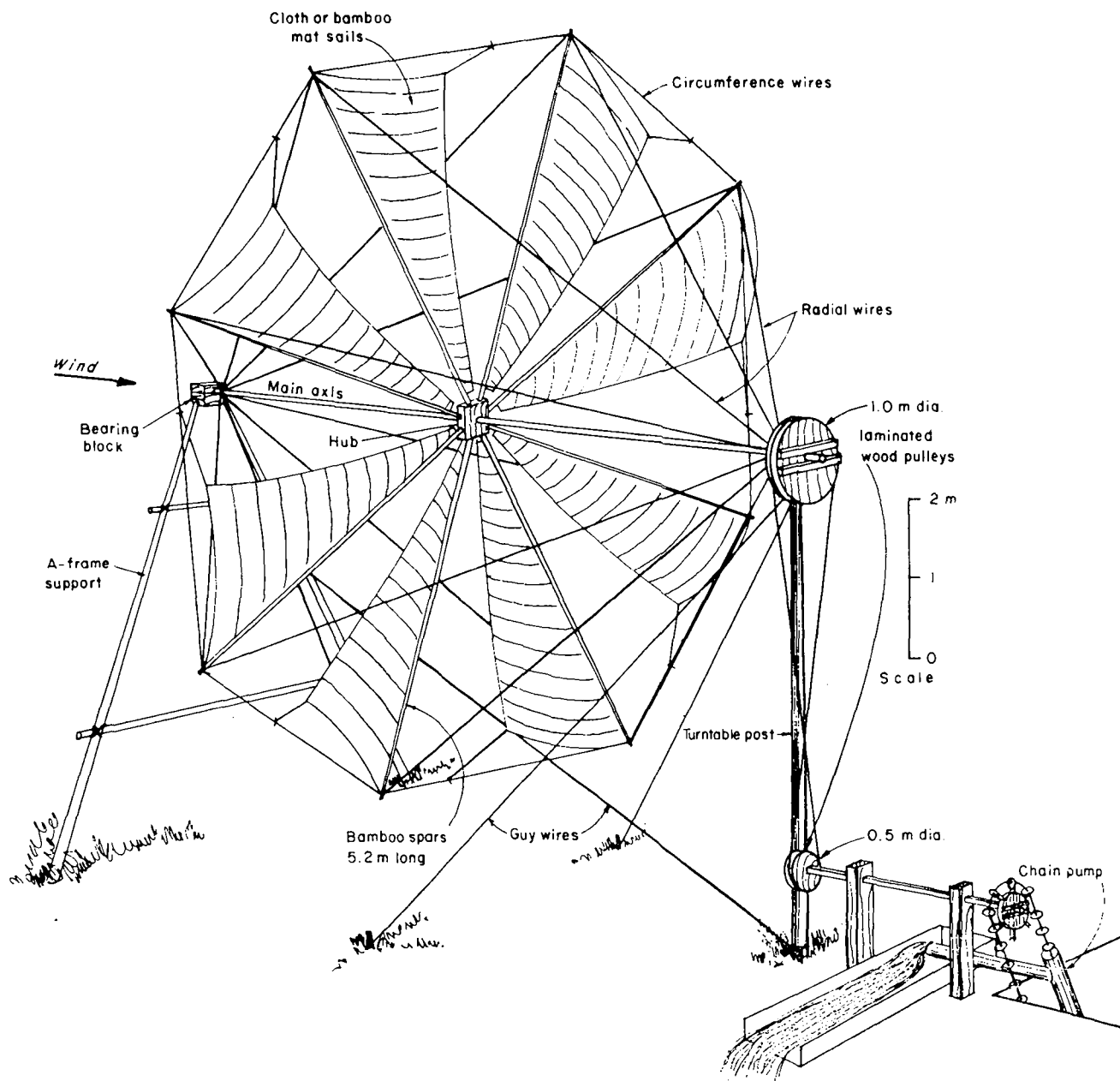

Figure 44. Hybrid Asian wind-powered water pumping system

## II. INFORMATION PAPERS PREPARED BY PARTICIPANTS

### A REVIEW OF EFFORTS MADE IN INDIA FOR WIND POWER UTILIZATION (NR/ERD/EWGSW/CR.3)\*

by

Mr. S. K. Tewari (India)

#### Introduction

A systematic approach to wind power utilization in India began with the formation of the Wind Power Sub-Committee in 1952 under the Council of Scientific and Industrial Research (see reference W 52). In 1955, a conference on large-scale utilization of wind power was held at New Delhi. Subsequently, the Ministry of Health procured 160 imported windmill pumping sets under an Indian-United States agreement. The windmills were Southern Cross type No. IZ-D, with rotor diameter 3.7 m.

By 1959, designs of a local water pumping windmill type No. WP-2 were standardized, and the manufacture of an initial batch of 200 was initiated by the Wind Power Division of the newly formed National Aeronautical Laboratory (NAL), at Bangalore. This type of windmill was considered suitable for lifting water for small-scale irrigation purposes and domestic water supply in rural areas. It was designed to start at low wind speeds of about 8 km/h and had facilities for automatic furling of sails in heavy winds. (For details refer table 1).

Table 1. DETAILS OF TYPE WP-2 WIND PUMP

Rotor:	4.9 m diameter, 12 blades		
Wind speeds:	8 km/h cut-in, 16 km/h rated, 48 km/h furling		
Tower:	Lattice steel, 4 legs, free-standing		
Pump:	Reciprocating, 12.5 cm stroke, single-acting		
Performance:	Pump diameter (cm)	Lift (m)	Output (m <sup>3</sup> /hour)
	25	3.0	13.5
	20	7.6	6.7
	15	15.2	3.4
	7.5	30.4	1.8

#### A. FEASIBILITY STUDIES

Studies were made to determine the adaptability of some European designs of windmills for use in India. About 1960, the Government of the Federal Republic of Germany presented an "Allgaier" wind-electric generator for trial and testing at NAL. This wind-electric generator was capable of producing 6 kW,

\* Abridged.

220 V DC at a wind speed of 32 km/h. It was installed and studied at Porbandar, Saurashtra (latitude 21°38' N, longitude 69°37' E). Table 2 provides some information related to this study (see also reference W 53). It was clear that the rated design speed of 32 km/h was too high even for a relatively windy location in India.

Table 2.

#### DETAILS OF ALLGAIER WIND-ELECTRIC GENERATOR

Rotor:	10 m diameter, 3 blades	
Wind speeds:	11 km/h cut-in, 32 km/h rated, 54 km/h furling	
Tower:	Tubular steel, one leg, guyed	
Generator:	6 kW, 220 V DC at 1,500 rev/min	
Performance:	Wind speed (km/h)	Output (kW)
	11	0.3
	18	2.0
	25	4.8
	32	6.0

A study was made to assess a Dowsett Holding type 25 kW wind-electric generator (see reference W 54). This machine was found to have very limited potential for utilization in India owing to its high rated speed.

By 1965, a 250 W, 12 V wind-electric generator was designed, to have a rotational speed of 400 rev/min with a rated wind speed of 25 km/h, and intended to supply the power requirements of solid state microwave radio links, using rechargeable batteries. This design was not developed further (see reference W 55).

#### B. WIND DATA ANALYSIS AND SELECTION OF DESIGN WIND SPEEDS

During 1960-1963, a programme for the analysis of available records of wind speed was carried out by the staff of NAL. Several reports were prepared, tabulating the data in relation to wind power utilization. A study of the data was recently carried out to enable some conclusions to be drawn for the country as a whole (see reference W 56).

A report (reference W 57) was published in 1963, in which an attempt was made to derive the optimum rated speed for maximum energy output and minimum cost. Minimum cost criteria were based on an earlier empirical study (reference W 58), according to which the capital cost of wind power installations increases in proportion to the design wind speed. There is some doubt about the general applicability of such an observation.

### C. UTILIZATION-ORIENTED STUDIES

An urgent need for the supply of water for drinking and minor irrigation purposes in widely distributed villages was identified. It was considered that cheap water pumping windmills, starting at wind speeds as low as 8 km/h, and capable of being constructed indigenously, could readily meet this need (see reference W 59).

A report published in 1963 (reference W 60) showed that distribution of rainfall and wind speeds during the year was such that peak wind speeds occur one to two months prior to the peak rainfall, and another report (reference W 61) showed that, for arid and semi-arid areas, the peak of wind power precedes the peak of rainfall by nearly two months. Another analysis (reference W 62) indicated that some villages in acute need of drinking water during summer could utilize wind power.

The possibility of extensive utilization of windmill-driven water pumping for irrigation has also been studied. The wind energy distribution during the year is such that about 58 per cent is available during the *kharij* crop when the need for water pumping is low, and about 22 per cent is available in the *rabi* season when the need for water pumping is at its maximum (see reference W 62).

Incorporation of wind power into the electricity grid on a substantial basis could add reliability and consistency to the electricity generated from hydro-electric stations (see reference W 63).

By 1973, about 26 per cent of the nearly half a million villages in India had been electrified. Most villages, not yet electrified, are scattered, and distant from the existing main load centres. An analysis is in progress at NAL to determine the feasibility of wind-electric generators located to meet the local energy requirements in these villages. The economics of wind-electric systems, compared with existing methods, are also being assessed. The preliminary estimates are in favour of utilizing wind power for this application.

### D. ECONOMICS

The question of economics is fairly involved. It is necessary to consider capital cost, interest rates, depreciation, maintenance and operating costs, and also to consider the reliability of energy supply in relation to the demand for energy for a given application. The latter relation is difficult to calculate.

An analysis was recently published in which energy cost was plotted against the maximum permissible investment for a variety of hypothetical windmills (see reference W 62). The conclusion of the analysis was that wind energy utilization at selected windy sites for centralized generation of electricity appeared to be the best proposition. The analysis was not very exhaustive and did not include any forecasts about rises in prices of materials, labour, fuels and rate of inflation. A more exhaustive study along similar lines is being attempted at NAL.

### E. RECENT DESIGN AND DEVELOPMENT EFFORTS

#### 1. Darrieus rotor

A design and development project was commenced in 1975 at NAL for a Darrieus rotor type windmill (see reference W 64). The investigation aimed at constructing a prototype to develop about 1 kW at a wind speed of 25 km/h. The purposes of the exercise were to understand and try to overcome the design and fabrication problems, and to test directly in the winds normally prevailing in India. Abridged specifications are given in figure 1. A self-priming, commercially available, centrifugal pump rated 1 hp at 1,440 rev/min was coupled to this windmill through a speed-raising mechanism of ratio 1:9.3.

The design and operation of this experimental prototype has provided some very useful information (see reference W 64). Attempts are being made to reduce the friction in the bearing system, to design an automatic clutch for coupling with electric generators and pumps, and to improve compatibility between the starting device and the main rotor.

A simplified method for calculating mean power coefficients was developed at NAL. A theory of uniform induced velocity was restated as a linear function for high tip speed ratios, and a simple formula was obtained. It was also found that predictions based on the uniform induced velocity theory appeared to be optimistic when compared with experimental results. The discrepancy was greater at tip speed ratios close to peak power output, and was considerably reduced by applying a simple non-uniform induced velocity theory (see reference W 65).

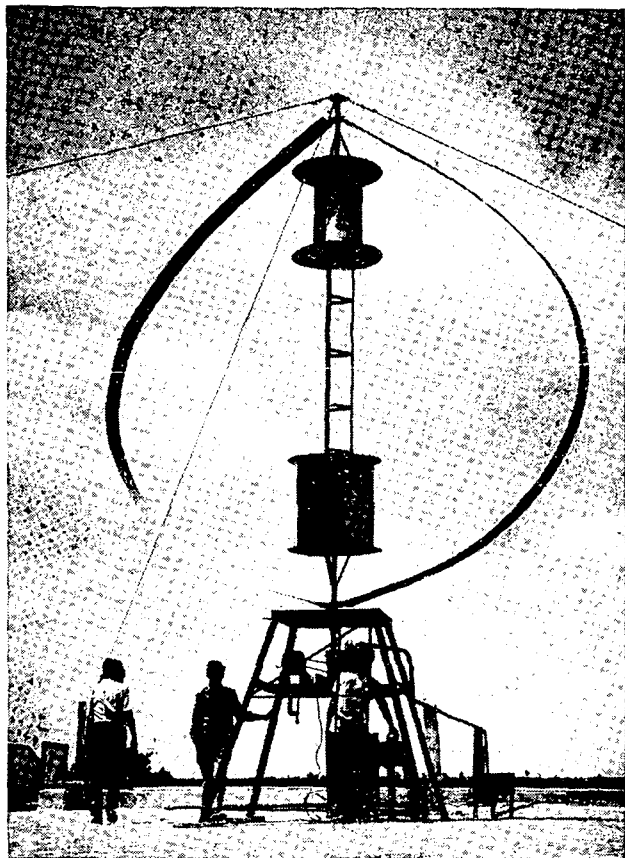

Figure 1.

Prototype vertical-axis wind-electric generator

Frontal area	17.2 m <sup>2</sup>
Blades	— 5-m diameter catenary NACA 0012 25-cm chord aerofoil
Starters	— 2 Savonius rotors, 1 m x 1 m
Output	— 1 kW at rated wind speed 25 km/h

## 2. Modified Savonius rotor

At the Indian Institute of Science, Bangalore, a low-cost modified Savonius rotor type windmill has been developed for rural application. The rotor uses

sails, supported by wires in tension. A prototype windmill 4 m high and 3 m diameter has been constructed, costing Rs. 1,500, excluding pumps. It is estimated that its efficiency is about 16 to 20 per cent, and that it produces 0.1 hp with a 15 km/h wind.

## 3. Permanent magnet generator

Bharat Heavy Electricals Ltd. have designed a 5 kW, 400 V, 3-phase, 50 Hz, 1,500 rev/min generator for windmills. The salient feature of this generator is the absence of a field winding on the rotor, thus avoiding slip rings, exciter and voltage regulator. The performance tests indicated that the permanent magnet generator was more efficient and inherently better regulated than a conventional AC generator (see reference W 66).

## 4. Further development of the WP-2 windmill

The Central Power Research Institute, Bangalore, has recently made some studies on the early WP-2 windmill. Some operational problems were identified, such as the frequent loosening of the pump rod, leakage of lubricating oil in the head mechanism and rather high sensitivity of the tail vane, and remedial measures are being incorporated. It was also found that this windmill had an over-all efficiency of 48.9 per cent for a 6 km/h wind, which was reduced to 6.4 per cent for a 16 km/h wind. For a lifting head of 5.8 m, the quantity of water pumped was 1,000 and 2,400 litres per hour with wind speeds of 6 and 16 km/h respectively.

## 5. Low-cost windmill

A 10-m diameter sail-wing type windmill was erected at Madurai as a demonstration of low-cost windmills (see reference W 31). This windmill had eight blades and used bamboo for the arms and canvas for the sails. The quantity of water pumped was estimated to be 1,635 litres per hour from a depth of 9.2 m, in low wind speeds of the order of 6 to 8 km/h. It was felt that this windmill could pump more water if a better-matching reciprocating pump were available.



**RESEARCH, DEVELOPMENT AND USE OF WIND ENERGY IN THAILAND**  
(NR/ERD/EWGSW/CR.5)\*

by

The National Energy Administration (Thailand)

### Introduction

Several types of windmills are commonly used for water lifting in some parts of Thailand. Most are locally constructed, using simple wood, bamboo and cloth materials and ordinary carpentering skills and tools, but some multi-bladed windmills are fabricated of metal in Bangkok. Considerable developmental work on improved windmills has recently been initiated, and international collaboration is sought for development of a medium-scale wind-electric generator appropriate for manufacture in the country.

#### A. WINDMILLS USED IN THAILAND

The locations of windmills in Thailand are indicated in figure 1. Locally-constructed windmills have been used for brine pumping along the Gulf of Thailand and for rice irrigation in the Chao Phraya delta for at least 40 years. Some details on these have recently been reported in reference W 20. Several types of windmills no longer in use have been reported by the Royal Irrigation Department (reference W 47). Since the introduction and large-scale adoption of small diesel and gasoline engine pumps by farmers, the construction and use of traditional windmills continues at a reduced rate. With some technical modifications and improvements, it is hoped that these windmills will be used more widely by farmers.

There is no evidence, at present, that any windmills are used in Thailand for electricity generation, although some people have tried to connect two-bladed wood rotor windmills to DC generators.

At present there are three basic types of windmills in active use for water pumping; the slow-speed sail rotor type, the high-speed wooden rotor type, and the multi-blade steel rotor type.

#### 1. Slow-speed sail rotor type

Several hundred 7 to 8-m diameter bamboo-mat sail rotors (figure 2) are used for brine pumping at the salt farms along both sides of a 10-km section of the highway near Samut Songkram. Each of the six sails of these windmills consists of a triangular mat woven from split bamboo and reinforced with nylon cord. Each sail is fastened by wooden slats and nails along its long edge to a bamboo spar radiating

from a 30-cm diameter wooden hub mounted in the centre of a 5-m long 10-cm square main shaft. The apex of each sail is held tight by a nylon cord loop connected to a 1-cm diameter nylon rope which is stretched around the rotor circumference between the tips of each spar. A manually-activated, quick-release sail-feathering device is incorporated at each loop connexion (see figure 3). The tips of each spar are braced by steel wires to points near the opposite ends of the main shaft. Each end of the main shaft is rounded to fit in a notch (journal bearing) cut in the top of each of the two vertical wooden supporting poles.

The stationary support structure of two wooden poles is set in the ground in a fixed direction to receive the winds of the southwest monsoon from one side and the winds of the northeast monsoon from the other side. Power is transmitted 12 m diagonally by a steel chain of 2.5-cm long open links from a 0.7-m diameter wooden pulley mounted at one end of the main shaft to a 0.5-m diameter wooden pulley near the ground which drives the power shaft of an open-trough wooden-pallet chain pump (reference W 49).

The results of two series of performance trials on one of these traditional Thai wind-powered water pumping systems is summarized in table 1 below.

Table 1. RESULTS OF PERFORMANCE TRIALS

	Number of trials	Average trial period (sec)	Average wind speed (km/h)	Pumping head (m)	Average discharge (litres/sec)
Series 1 . . .	10	39.1	17	0.55	17.3
Series 2 . . .	6	35.0	13	0.60	12.8

Detailed technical drawings of this type of windmill have been prepared by the Agricultural Engineering Division, Ministry of Agriculture and Co-operative.

These bamboo-mat sail windmills are constructed on site by their owner/operators, using a minimum of carpentry skills and tools. The lifetime and cost of the components are enumerated in table 2.

Assuming that a Thai bamboo-mat sail wind-powered pump operates 8 hours per day, 20 days per month, 8 months of the year at an average pumping rate of 15 litres per second, the cost of water pumping is 0.0167 baht per cubic metre, which is equivalent to \$US 0.83 per 1,000 m<sup>3</sup> (at the exchange rate of 20.15 baht per \$US 1.00).

\* Abridged.

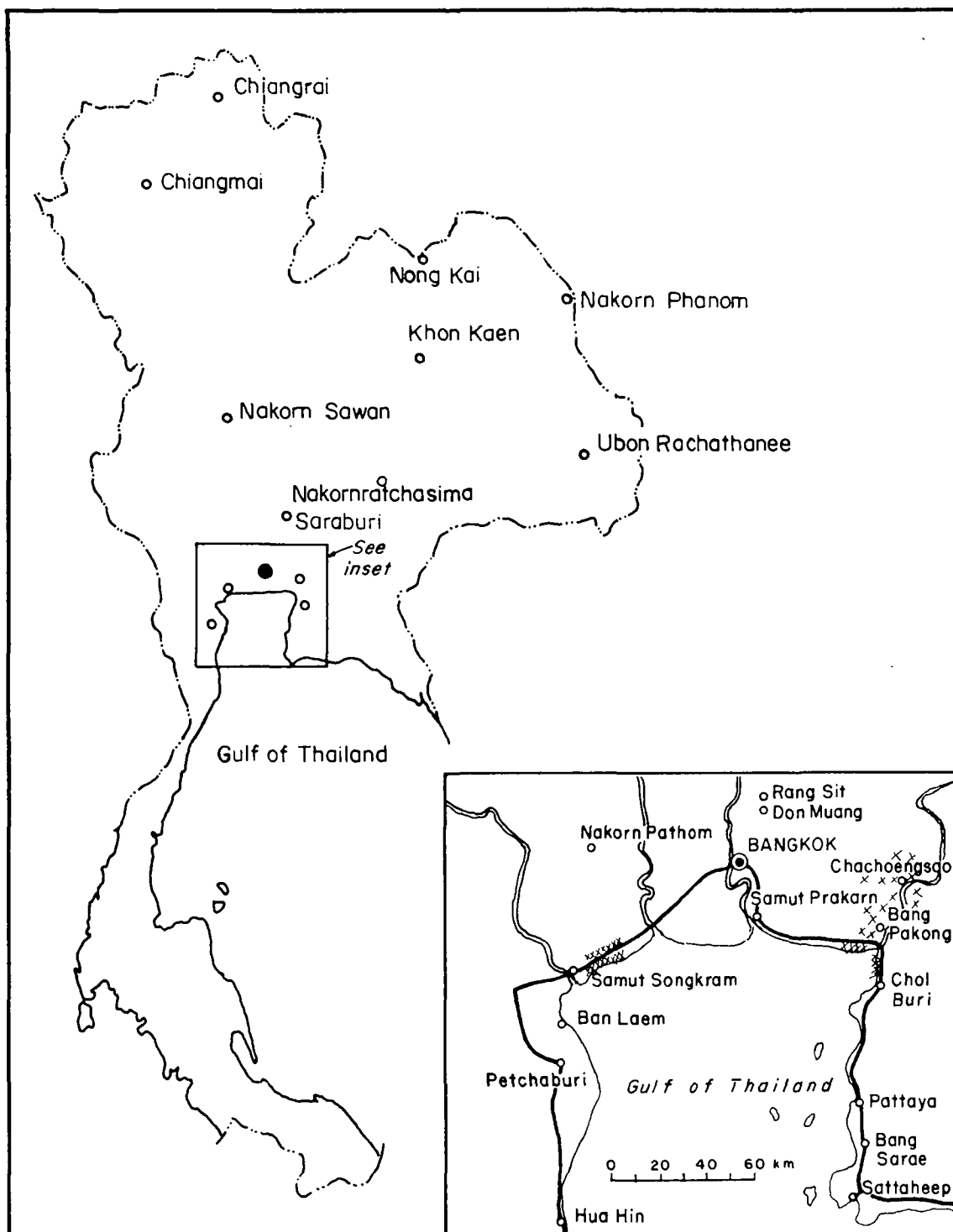

Figure 1. Map of Thailand indicating windmill locations

Table 2. TYPICAL COST AND LIFETIME OF COMPONENTS OF BAMBOO-MAT SAIL WINDMILL

Component	Quantity/cost (baht)	Initial cost (baht)	Ten year cost (baht)	Lifetime (years)
Rotor-sail, bamboo mat . . .	6 @ 23	138	1,380	1
Wood slats . . . . .	6 and nails	85	170	5
Nylon cord . . . . .	2.5 kg @ 35	88	880	1
Nylon rope . . . . .	4.0 kg @ 35	140	1,400	1
Steel wire . . . . .	5.0 kg @ 30	150	300	5
Bamboo spars . . . . .	6.0 kg @ 5	30	100	3
Wood main shaft . . . . .	10 cm × 10 cm × 5 m	200	200	10
Wood hub . . . . .	1	100	200	5
Supporting poles . . . . .	2 @ 250	500	500	10
Power transmission . . . . .	chain 24 m	800	800	10
Upper pulley . . . . .	1	200	666	3
Lower pulley . . . . .	1	200	666	3
Wooden-pallet chain pump	1	3,000	4,286	7
Total . . . . .		5,631	11,548	

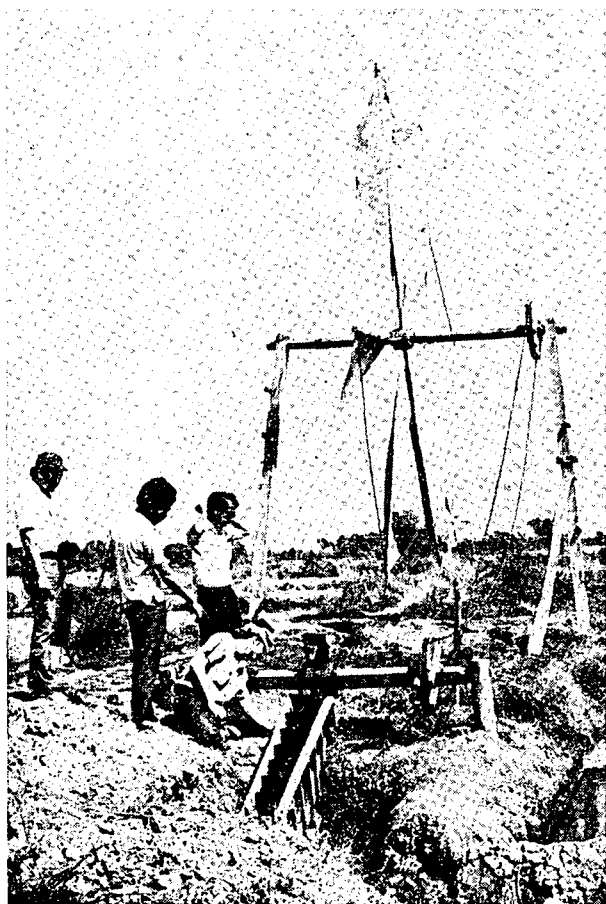

Figure 2. Bamboo-mat sail windmill

About 30 cloth sail windmills are used for brine pumping at three salt farm areas near Chol Buri, along the Bangkok-Chol Buri highway. This type of windmill is also known to have been used at Ban Laem, Petchaburi, the largest salt-producing area in Thailand, but they have been replaced with diesel and gasoline engine pumps because of the advantages of portability and greater control over water pumping. The Chol Buri sail windmills vary from those near Samut Songkram in that the 7-m diameter rotor consists of eight trapezoidal cloth sails (see figure 4). The cost of the cloth sail variation of the bamboo-mat windmills is about 5,000 baht including the wooden-pallet chain pump.

## 2. High-speed wooden-rotor type

High-speed wooden-rotor type windmills are commonly used for water pumping in the coastal provinces of Chachoengsao and Samut Prakarn, southeast of Bangkok. These windmills are used for lifting brine at the salt farms near Bang Pakong, and for water lifting for rice irrigation in the Chao Phraya delta, especially in the paddy areas surrounding Chachoengsao (see figure 5).

The rotors of these windmills consist of two or four wooden blades. Two blades are generally used nearest the coast in higher winds, while four blades are used inland where lower wind speeds would cause self-starting problems for the two-blade rotors. Four blade rotors are sometimes used near the coast for

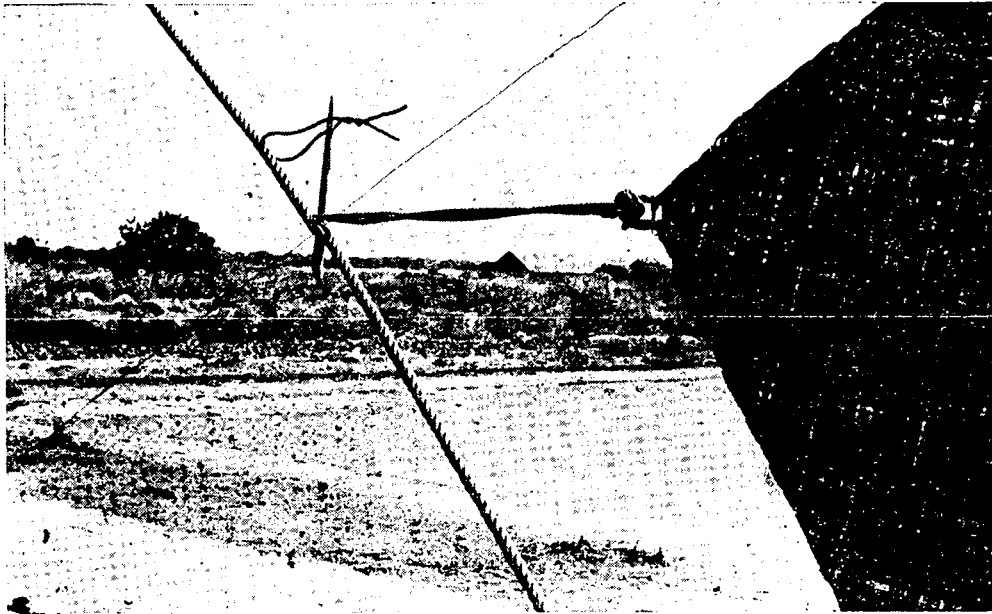

Figure 3. Quick-release sail-feeding device

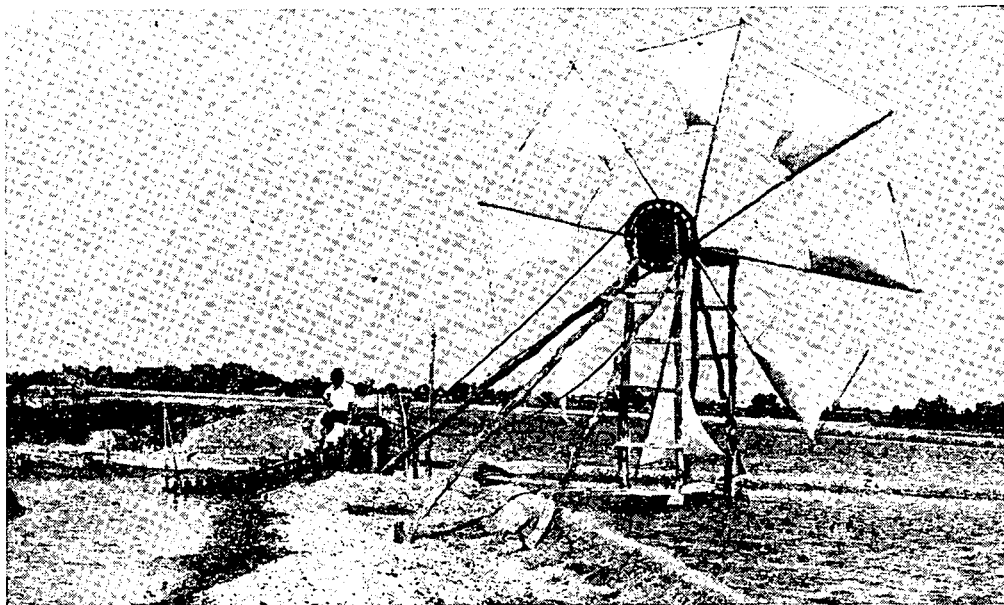

Figure 4. Cloth sail windmill

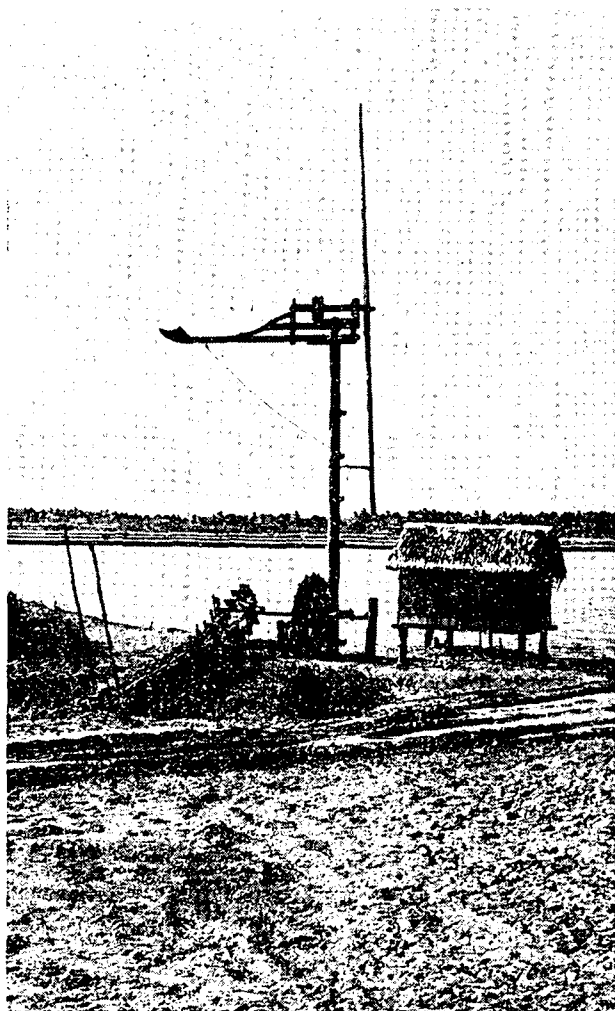

Figure 5. High-speed wooden-rotor windmill

higher lift, higher torque loads. Each pair of blades is carved from a single hardwood plank 8 m long, 20 cm wide and 5 cm thick so that it forms a crude but effective aerofoil, including some twist.

In some places, four triangular cloth sails fitted to wooden spars are used to replace the high-speed wooden rotor on this device so that the mechanism will operate in lower wind speeds.

Each rotor is fastened in the centre by four bolts to a small steel plate hub welded to the end of a 3-cm diameter, 60-cm long steel main shaft. The steel main shaft rests in two steel ball bearings mounted in the front and rear vertical members of the wooden supporting frame. Older high-speed windmills simply utilize a 9-cm square wooden main shaft rounded at each end to turn directly on a wooden bearing surface. Power is transferred by a twisted cowhide rope or steel chain from a 0.35-m diameter wooden pulley attached to the shaft directly to a 1-m diameter wooden pulley

on the lower shaft of the wooden-pallet chain pump. The cowhide rope or chain transmission can be twisted through 180° in response to changing wind direction. The horizontal top and bottom planks of the frame each have a round hole about 10 cm in diameter to match a short 10-cm diameter section cut at the top of the 25-cm diameter and 5-m tall single wooden pole tower.

The approximate cost and lifetime of the components of this wooden-rotor pumping system are summarized in table 3. A performance test of 10 pumping trials on one of these pumping systems with 0.9-m lift indicated that an average of 25 litres per second is pumped in an average wind speed of 21 km/h. Detailed drawings of this type of windmill have been prepared by the Agricultural Engineering Division.

Table 3. APPROXIMATE COST AND LIFETIME OF COMPONENTS OF A 2-BLADE WINDMILL

Component	Initial cost (baht)	Ten year cost (baht)	Lifetime (years)
Rotor — two 3-m long blades and one 5-cm diameter steel shaft with roller and taper bearings	2,800	1,400	20
Supporting structure — 3 wood poles 25-cm diameter × 10-m long	600	600	10
Cowhide belt	—	—	5
Ladder pump	2,000	2,850	7

These windmills are manufactured upon order at a carpentry shop in Chacheongsao. Before the introduction of small gasoline pumping units, this shop produced and sold more than 200 windmills per year.

### 3. Multi-blade steel rotor type

Multi-blade windmills were introduced to Thailand more than 10 years ago, and more than 20 have been sold in several areas of Thailand. There have been few recent sales because of the high initial cost. Eight 4.9-m diameter "Demster" multi-blade (water pumping) windmills were imported by the Division of Agricultural Economics, Ministry of Agriculture and Co-operative (see table 4), and two replicas were manufactured by the Division.

Simpler 2.4-m diameter multi-vane windmills have been designed and made by a small-scale manufacturer in Bangkok (see figure 6). These are similar to the American fan mill, except that the Thai variation (known as Sanit) uses a crankshaft instead of a gear mechanism to transmit power from horizontal rotary motion to vertical reciprocating motion. This windmill is used with a 7.6-cm diameter piston pump with 10.2 cm stroke. The output of this windmill at the starting wind speed of 6 km/h is 500 litres per hour, and output at 10 km/h is 800 litres per hour. Eight

of these windmills have been distributed to several locations (see table 4) within the past five years (including some provided to the villagers in the northeast provinces by the Military Mobile Development Unit), and the manufacturer hopes for further sales. It is probable that expert design optimization could result in significant cost reduction of this device.

It was reported by the manufacturer's representative that 300 Southern Cross multi-blade windmills have been sold in Thailand in the past 15 years but the location of these mills has not been determined.

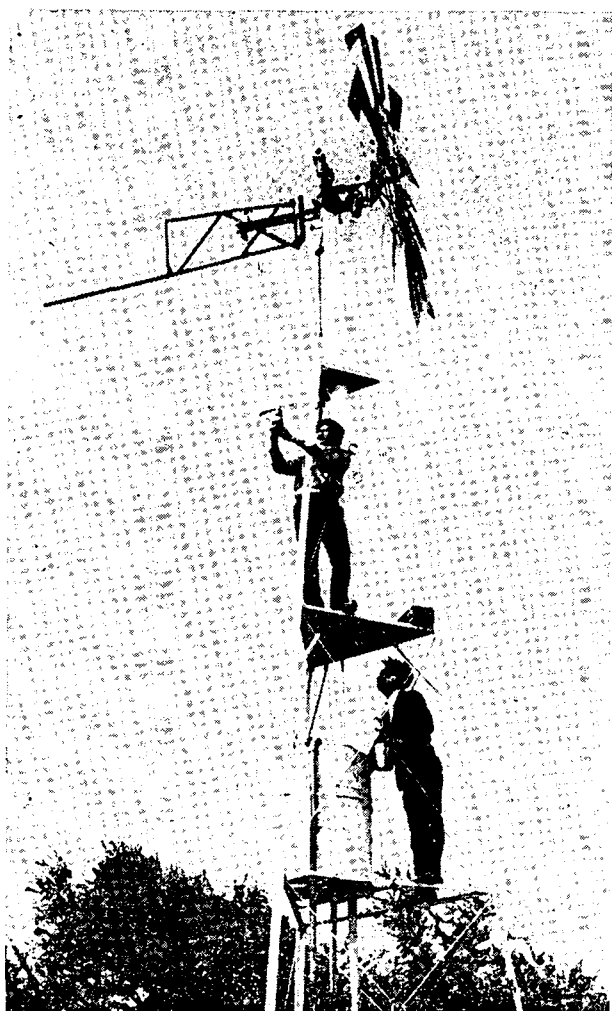

Figure 6. Locally-made multi-vane windmill

B. CURRENT ACTIVITIES

After the energy crisis, much attention has been given to harnessing wind energy in Thailand. The simple traditional windmills have been re-examined, and other types are being developed for both pumping water and DC electricity generation. Several organizations are concerned in these developments.

Development of improved water pumping windmills within the Ministry of Agriculture and Co-operative is actively patronized by his Majesty King Bhumipol.

1. The Agricultural Engineering Division, Ministry of Agriculture and Co-operative, has a programme under way for experimental wind-powered water pumping units. One of the experimental windmills is a variation of the Chinese vertical-axis type constructed from a combination of metal, wood and bamboo mats. It is the intention to develop this type of windmill for low-cost operation on farms.

2. The Division of Agricultural Economics, Ministry of Agriculture and Co-operative, has conducted economic trials of windmill pumps for farms in four provinces, using ten Demster windmill pumps (eight imported and two copies made by the Division). The results, analysed from data collected over four years, indicated very successful operation. The cost of each locally-made windmill can be recouped out of the incremental agricultural production in about four years. The Division strongly suggests that more farmers use these windmills.

3. The Royal Irrigation Department, Ministry of Agriculture and Co-operative, has recently installed an improved four-bladed water pumping windmill at Wat Bang Chak, Ang Tong province, for lifting water from the Noi River to irrigate a bean crop of 16 acres to replace a crop lost in the floods.

4. The Meteorological Department, Ministry of Communications, has more than 50 weather stations throughout Thailand, from which wind velocity data based on hourly readings are available, for preliminary evaluation of wind energy potential. These existing weather stations can be modified to record wind data continuously, as required for comprehensive wind energy evaluation prior to extensive windpower development in the country.

Table 4.  
LOCATION AND NUMBER OF MULTI-VANE WINDMILLS

<i>Demster</i>	<i>Sanit</i>	<i>Others</i>
	Udorn Thanee (2)	
Nong Kai (4)	Burirum (1)	Ban Dan, Samut Prakarn (2)
Petchaburi (1)	Surin (1)	Pattaya (1)
Saraburi (3)	Bang Sarac, Chol Buri (1)	Hua Hin (1)
Nakorn Phanom (2)	Bang Khen, Bangkok (3)	

5. The National Energy Administration (NEA), Office of the Prime Minister, is interested in the development of small-scale renewable energy sources, and, in September 1975, established an Energy Research and Development Unit. NEA has gathered much relevant literature concerning wind energy and other renewable forms of energy, and has assessed wind data obtained from the Meteorological Department. A group of NEA engineers has been investigating traditional uses of windmills in several areas and is also preparing detailed questionnaires. A research centre (which will carry out testing of different types of windmills) is under construction at Rang Sit, near the Asian Institute of Technology.

NEA has also proposed a five-year plan, starting from the year 1977, on research and development of alternative energy sources, which includes wind energy. This proposal is under consideration by the National Economic Development Board. The goals of the wind energy section are to:

(a) Carry out research and improve efficiency of wind energy use for water pumping in salt farming, fish culture, irrigation, and domestic use in villages;

(b) Develop wind energy units for mechanical and electrical power sources in the villages as a substitute for sources of energy based on petroleum products.

The programme of research and development for the five-year plan includes:

(a) Gather all available literature concerning wind energy;

(b) Purchase wind-measuring instruments, and install at locations of interest;

(c) Collect, compile, analyse and assess wind data from the Meteorological Department and NEA stations;

(d) Survey the present use of wind energy in Thailand;

(e) Make improvements on traditional Thai windmills;

(f) Design, construct and test a slow-speed windmill for multiple uses;

(g) Purchase and test a small-scale wind-electric DC generator;

(h) Install several improved windmills as demonstration units (water pumping and provision of mechanical power);

(i) Survey the electricity demand in the remote areas where wind data have been collected;

(j) Design, construct and evaluate a large-scale windmill pump at the NEA electrical pumping station on the Mekong River; followed by adaptation of the design, and construction of a 5-10 kW wind-electric generator;

(k) Apply similar units where appropriate;

(l) Evaluate over-all progress in wind research and plan developments in the next five-year plan.

6. Private industry. The small-scale manufacturer in Bangkok which has successfully designed and constructed multi-blade type windmills plans to develop less expensive wooden-blade type windmills for farmers, and has also developed a sail-type windmill (with aluminium sheet sails) which can be used with either a ladder pump or a piston pump.

Australian multi-blade windmills are distributed in Thailand.

A manufacturer in Chachoengsao has designed and constructed two-blade and four-blade windmills for many years, and also produces all sizes of ladder pumps.

### C. REQUIREMENT FOR COLLABORATION ASSISTANCE

Wind energy utilization is a new field of technology development in Thailand. Technical assistance in the development of windmills for generation of electricity in rural areas, and pumping from the Mekong River for large-scale irrigation, would be welcomed. Assistance will be needed in the supply of medium-scale wind-electric generators and related testing equipment for further development and tests.

## THE UTILIZATION OF WIND ENERGY IN AUSTRALIA (NR/ERD/EWGSW/CR.13)\*

by

The Department of Science, Australia

### Introduction

The wind has been harnessed as a source of power in Australia since early colonial times, when windmills of traditional European design were used to grind wheat. The manufacture of windmill pumps on a large scale was stimulated by the discovery of extensive artesian and sub-artesian basins, and designs were evolved to meet the high standard of reliability required for long periods of unattended operation, far from maintenance facilities. Today, it is estimated that more than 250,000 windmill pumps are in use, supplying bore, well and surface water for irrigation, stock watering and domestic use on farms and stations throughout Australia.

Until recently, wind-driven generators were also widely used, but they have now been largely supplanted by diesel generators and extended rural mains electricity supplies, and only one Australian firm continues to manufacture them. A large proportion of the generators is exported, chiefly to the United States and southeast Asia. The major user of wind-driven generators in Australia today is the Australian Telecommunications Commission (ATC), which employs them to supply electricity to isolated telephone exchanges and radio repeaters.

### A. WINDMILL PUMPS

The products of the various Australian manufacturers of windmill pumps vary in the details of their design, but in general follow a basic pattern. The rotary motion of a multi-blade rotor is converted by means of a crank mechanism to reciprocating motion of a vertical pump rod connected to a piston pump at the bottom of the supporting tower. Reduction gearing is frequently employed in some models, while in other windmills the rotor is directly coupled to the crankshaft. The windmill head can rotate freely about a vertical axis defined by the pump rod and is aligned by a tail vane according to wind direction.

Wind pressure on the rotor exerts a torque about the vertical axis of rotation due to the offset disposition of the rotor axle, and, at potentially destructive wind speeds, the windmill head turns so as to spill wind and limit the speed of rotation.

No major research or development programme is being carried out in Australia in connexion with windmill pumps. Manufactured pumps have operational lifetimes of more than 30 years, and pumping capacities are matched to the requirements of the Australian market. There is little incentive for manufacturers, who also produce competing diesel and electric pumps, to commit large sums to development work in this area. There are, of course, occasional minor changes in design, resulting in increased efficiency or reliability, or reduced costs.

### B. WIND-DRIVEN GENERATORS

The "Dunlite" generator employs a three-phase rotating field alternator with a rated maximum output of 2 kW. Current for the rotating field is supplied by a small exciter armature. The alternator is driven by a three-blade variable-pitch propeller through 5:1 ratio gearing, and a vane maintains the correct position of the propeller in relation to wind direction, the whole machine being able to rotate in a horizontal plane above a fixed base. The alternator output is rectified before being transmitted to the base by a set of slip rings. Solid-state automatic voltage regulation and control equipment holds the generator output voltage steady, between 12 and 110 volts depending on the model, under all conditions of load and windmill speed, and channels power to the load or to storage batteries as required. The operation of a back-up diesel generator can also be controlled automatically. The generator starts to deliver power at a wind speed of about 16 km/h and full output is obtained at a wind speed of 40 km/h. The power output of a generator, as modified by ATC, is plotted against wind speed in figure 1.

At high wind speeds, the speed of rotation of the propeller is governed by the centrifugal force on a set of weights attached to the propeller assembly, acting to feather the blades. A system of magnetic latching device, and the consequent loss of efficiency, in the normal operating range of the generator. It is claimed that, when fitted with the standard 3.69-m diameter propeller, the unit will withstand wind speeds of up to 130 km/h. Shorter blades are available if higher wind speeds are likely to be encountered.

ATC has also monitored the performance of the generators under operational conditions. About 30

\* Abridged.



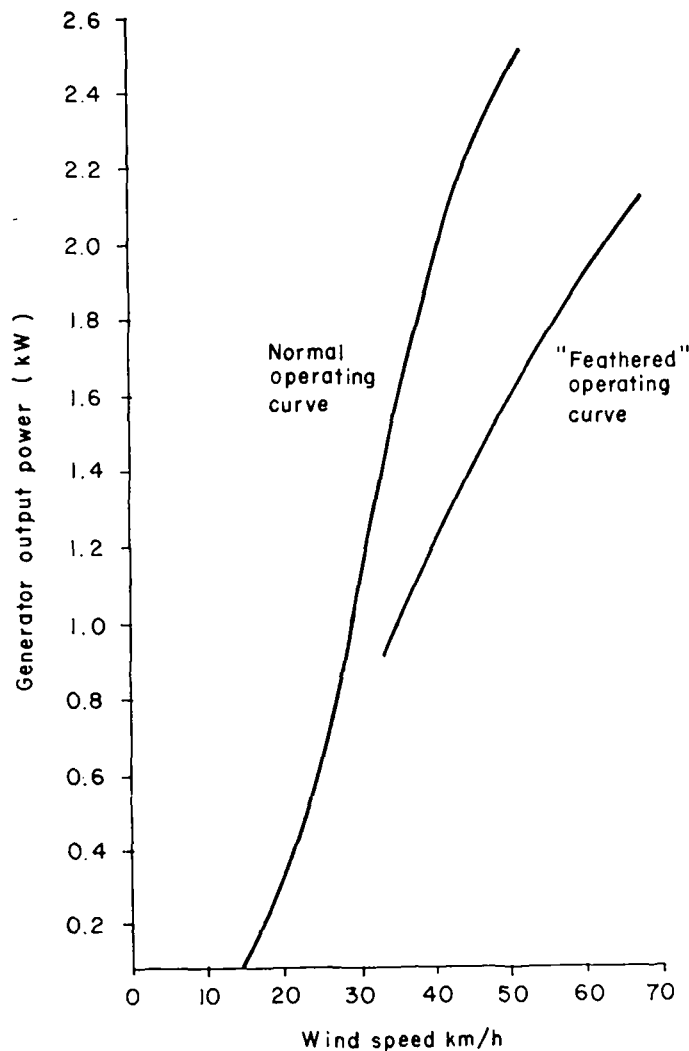

Figure 1. Characteristics of modified Dunlite generator

generators are used to meet part of the power requirements of repeater stations on a microwave route linking Western Australia and South Australia. The wind-driven generators each operate in conjunction with a 4 kW diesel generator, and storage batteries of 1,000 Ah capacity, the normal load being a continuous 0.5 kW at 24 V. With average wind speeds in the region of 18 km/h, the wind generators were found to be meeting about 66 per cent of the load, and, at many stations, the total running time of the diesel generator over five years was limited to 3,000 hours.

Simultaneous measurements of the output of a standard Dunlite generator and wind speed are currently being conducted at the Flinders University in South Australia. The results, when available, will serve as a data base for the manufacturer's development programme. A 5 kW generator is currently under development, and a prototype is expected to be ready for testing within a year. Future work will be con-

cerned with improving the efficiency of the propeller so that better performance is obtained at low wind speeds.

### C. OTHER RESEARCH

Research and development associated with the exploitation of wind energy is almost exclusively conducted by manufacturers of wind-driven machinery. There is no official wind energy research programme in Australia, and no university or other research organization is formally engaged in research in this field. However, a few university scientists have a personal interest in the subject, and at least one has published some general ideas on the large-scale utilization of wind energy (reference W 67). The topic is an attractive one for private inventors, one of whom recently received a government grant for the construction of a prototype of a modified version of the vertical-axis Savonius rotor.

## A REVIEW OF RENEWABLE ENERGY IN NEW ZEALAND WITH EMPHASIS ON WIND POWER UTILIZATION (NR/ERD/EWGSW/CR.15)\*

by

Mr. R. E. Chilcott (New Zealand)

### I. RENEWABLE ENERGY IN NEW ZEALAND

In New Zealand, oil, coal, natural gas and electricity are consumed at a rate equivalent to about 3.5 kW of continuous power per person (reference W 68). Oil supplies about 60 per cent of the primary energy requirements. In 1975, the generation of electricity per head of population was about 6,000 kWh, which is equivalent to a continuous electrical power of nearly 700 W per person. Renewable hydroelectric and geothermal sources supplied 78 per cent and 7 per cent respectively, the remaining 15 per cent being supplied from fossil-fired thermal-electric power stations. About half of the electricity generated flows into the home: the annual amount of electrical energy consumed by an average family is about 8,000 kWh, half of which flows down the drain in the form of hot water.

#### A. SOLAR ENERGY

The intensity of solar radiation is about 1,400 W/m<sup>2</sup>; this figure is known as the "solar constant."

As the surface area of a sphere is four times its cross-sectional area, the global average intensity of solar radiation perpendicular to the top of the atmosphere is one quarter of the solar constant, or about 350 W/m<sup>2</sup>. Owing to reflection from cloud tops, diffusion and absorption in the atmosphere, the global average intensity of solar radiation incident on a horizontal plane at the surface of the earth is about half this value. The annual average value of solar radiation in the region of the Tasman Sea and Pacific Ocean near New Zealand is about 150 W/m<sup>2</sup>. More precise figures for North Island and South Island stations are shown in table 1 (see reference W 69). The typical annual cycle of solar radiation and temperature, in which temperature lags behind radiation, is shown for Wellington in figure 1.

#### B. HYDRO AND THERMAL ELECTRICITY

Hydroelectric energy is a familiar form, derived from solar energy through the hydrologic cycle. Hydroelectric works currently planned will increase the total national installed hydroelectric capacity to about 4,500 MW by 1983. Ultimately, the capacity may be stretched to about 6,000 MW, but the later projects would become increasingly expensive and limited by environmental considerations (see reference W 70). By the end of the century, hydropower may only meet about 5 per cent of the projected total energy demand (see reference W 71).

\* Abridged.

### C. GROWING ENERGY

Solar energy is captured by photosynthesis and stored as wood fuel which is virtually sulphur-free. The ash can be returned to the land and the global heat balance will not be disturbed. Typically, an annual average solar radiation intensity of 170 W/m<sup>2</sup> is assumed to give an over-all photosynthetic conversion efficiency of about 0.4 per cent. It has been suggested that 0.7 per cent could easily be achieved by appropriate planting and double cropping and that ultimately an efficiency of 1 per cent may be possible (see reference W 72). The success of the solar forest or fuel plantation concept depends on many factors, including the selection of trees that grow fast on poor soils.

Research on the production of fuel from New Zealand crops is currently under way (see reference W 71). Indications in the United States are that alcohol from grain may soon become cost-competitive with ethyl-alcohol derived from oil. However, grain crops may be heavily subsidized by fertilizers dependent on fossil fuels, in which case the net fuel energy cost needs careful analysis (see references W 73, W 74, W 75). Similarly, growing and harvesting algae or giant kelp for alcohol production is likely to have significant energy costs for harvesting and processing. Research into the energy costs of crop production is being undertaken at Lincoln College. It appears that, without careful planning, processing and management, the net energy production may well be zero.

In Canterbury, energy-conversion efficiency of wheat at the farm gate is about 0.1 per cent. At this efficiency, to produce the food energy consumed by the average resident requires a land area of about 0.1 ha. The population density should therefore not exceed 10 persons per hectare of agricultural land (see reference W 76). Among other things, this highlights potential conflicts between energy, food and population requirements.

#### D. SOLAR HEAT

One of the most effective uses of solar energy is the direct heating of water for non-domestic and domestic purposes (see references W 77, W 78, W 79).

An installation currently under test at the National Dairy Laboratory, Ruakura, consists of a 16 m<sup>2</sup> bank of collectors inclined at 35° to the horizontal and mounted on a milking shed roof to face north-northwest (see figure 2). A circulating pump and an 800-litre

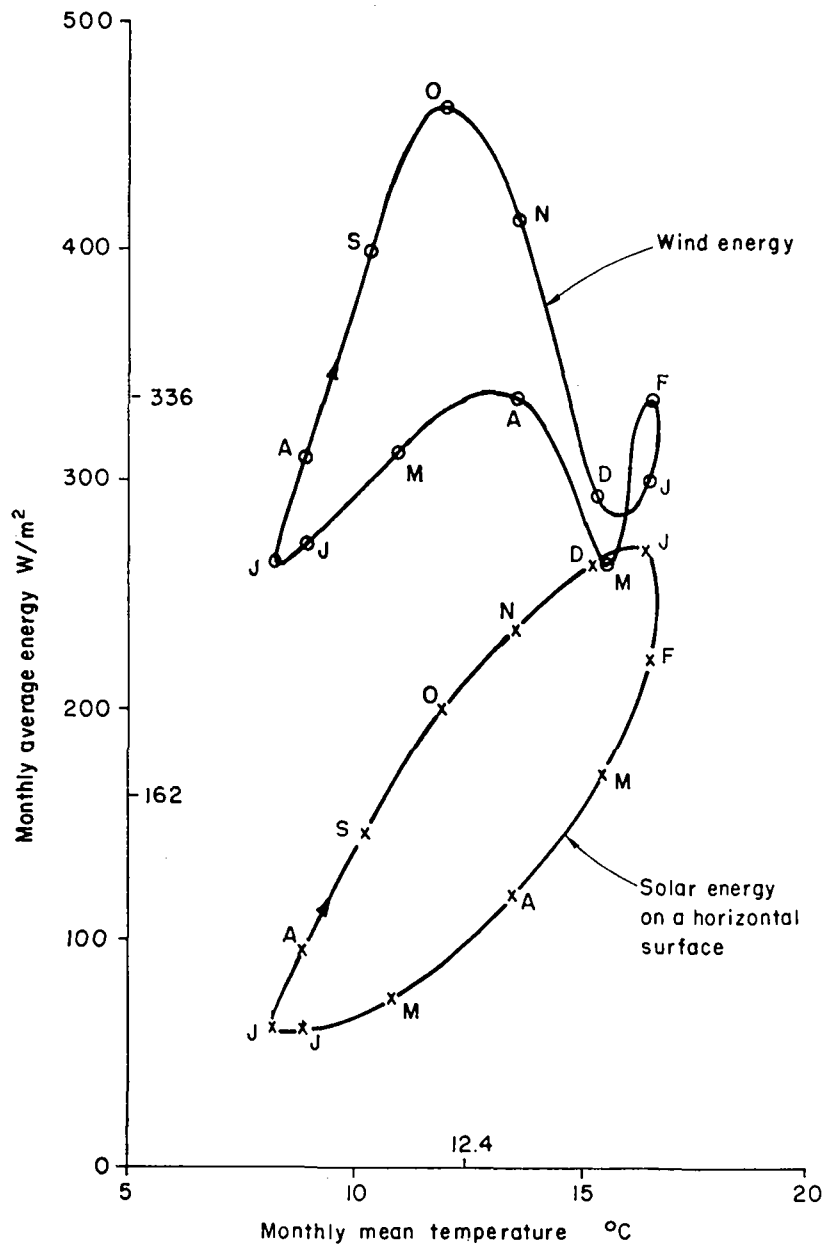

Figure 1. Wellington monthly average solar and wind energy

storage tank are located under the roof. The heated water is used to fill two conventional 200-litre hot-water heaters twice a day, and the electrical supply is used only to boost the water temperature to 90°C or more. From March to August 1975, the installation averaged a solar input of about 200 W/m<sup>2</sup> of collector area.

If required, collectors can be designed to produce low-pressure steam for food processing, industrial processing and power production. A solar-to-electrical energy conversion efficiency sometimes quoted is 10 per cent, which on 1 per cent of land area implies an over-all energy conversion efficiency,

on a total land area base, of 0.1 per cent. More conventional uses of solar heat include glasshouses, air heating for drying fruit, grain and timber, and the production of solar salt, for example from Lake Grassmere. With collectors in the form of large non-convecting ponds, it is possible to derive power, particularly where sea water and land are available (see reference W 71). Marine solar-derived thermal energy can be tapped only where sufficient temperature difference exists, usually more than 20°C, and is unlikely to find wide application in New Zealand waters (see reference W 80).

Many small-scale solar water-heater installations, which take advantage of the distributed nature of solar energy and do not take up valuable land area, are operating successfully in a variety of applications ranging from ice-prevention for stock-water troughs to solar water-heating at the Kaikoura youth hostel. Solar water-heaters will probably become widely accepted as architectural features of new towns, factories, schools, swimming pools and homes. Department of Scientific

and Industrial Research estimates indicate that about half the total domestic hot water used in New Zealand could be heated by solar energy; the fraction varies with locality and is typically about 50 per cent for Dunedin and 60 per cent for Blenheim. Ideally, a solar system, in addition to being economically viable, should generate more energy than is needed for its manufacture, installation and maintenance (see reference W 71).

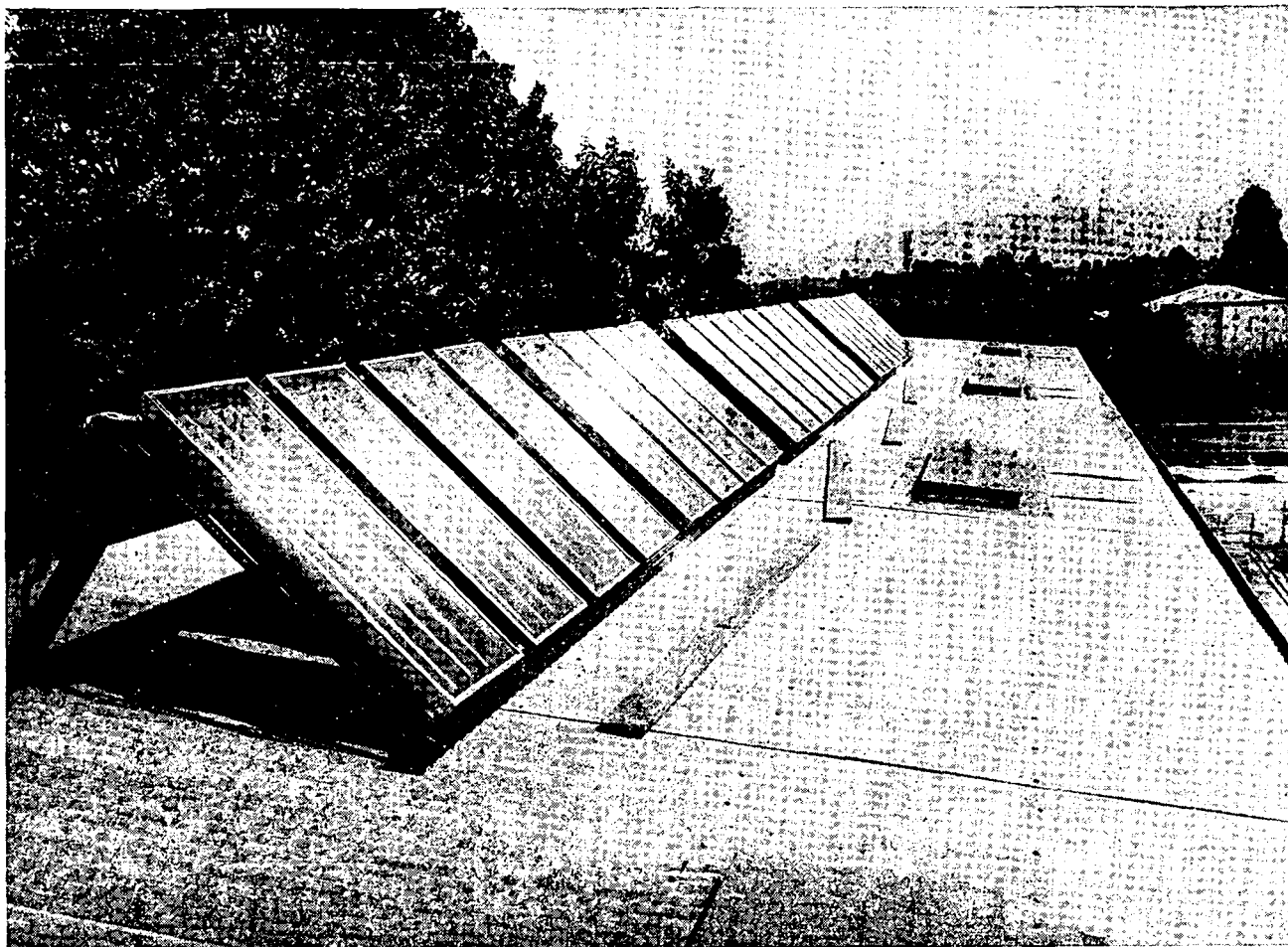

Figure 2. Solar collectors at National Dairy Laboratory

### E. WIND POWER

The long-term average value of the kinetic energy of the atmosphere is fairly constant and is estimated at about  $3 \times 10^{17}$  kJ (see reference W 81).

The flight path of a balloon released from Christchurch gives a graphic indication of the circulation of the atmosphere around the southern hemisphere at that latitude (see figure 3). A rough estimate of the balloon's average speed during three circuits of the earth in 33 days, at a height of 12 km, is 130 km/h.

From observations of the isobar spacing on weather maps, it is seen that gradient wind speeds of up to 100 m/s may occur occasionally. Near the surface of the earth, in the lowest 500 m, the surface exerts a frictional drag on the air and reduces the wind speed: this effect is greater over forests and lesser over the sea.

Surface wind speed is usually measured by anemometers at a height of 10 m. Zones of medium wind speed, such as the Canterbury Plains, have an annual average wind speed of 14 to 22 km/h, while more exposed locations, such as the Wellington area,

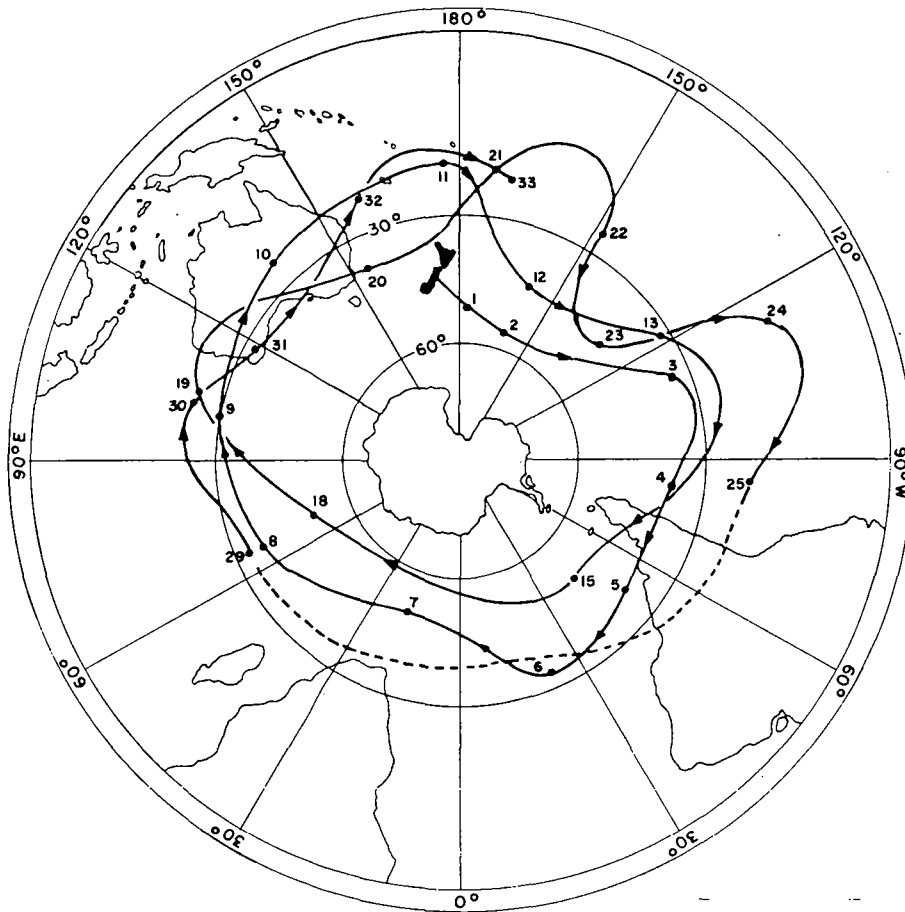

Figure 3. Flight path of a balloon launched from Christchurch (33 days)

Stewart Island and the Chatham Islands, have higher annual average wind speeds, in the range 22 to 33 km/h (see reference W 82). An over-all annual average wind speed at 10 m height for New Zealand might be taken as 18 km/h. The annual average wind power intensity at 10 m is about 150 W/m<sup>2</sup>; above 10 m it would be greater. There are of course significant variations in wind speed, wind frequency and wind energy between stations, for example Wellington has about three times as much wind energy available as at Christchurch (see table 1). A conservative estimate of the allowable installed wind-electrical capacity of a zone of medium wind speed is about 5 kW/ha, with a load factor of about one third. This means that, in such a zone in New Zealand, the available annual average wind-electric energy is about 0.1 per cent of the annual average solar energy incident on a horizontal plane.

Small windmills have been in use in New Zealand for at least a century. Typically, they were used to lift water for steam locomotives and are still used extensively for watering stock. In remote areas, small wind generators are used with storage batteries for

Table 1.  
ANNUAL AVERAGE TEMPERATURE, SOLAR ENERGY,  
WIND ENERGY AND WIND SPEED IN NEW ZEALAND

Station	Temperature (°C)	Solar energy (W/m <sup>2</sup> )	Wind energy <sup>a</sup> (W/m <sup>2</sup> )	Wind speed <sup>a</sup> (km/h)
Auckland . . . . .	14.0	171	108	13
Ohakea . . . . .	13.1	173	178	17
Wellington . . . . .	12.4	162	336	22
Christchurch . . . . .	10.9	165	114	14
Invercargill . . . . .	9.5	147	214	17

Sources: New Zealand Meteorological Service Miscellaneous Publication No. 143 and references W69 and W82.  
<sup>a</sup> Nominally at 10 m height.

electric fence energizing, communications and marine navigation lights. It has been suggested that wind generators could be integrated into existing electrical networks in order to supplement hydroelectric sources and conserve fossil fuel. In order to determine if sufficient wind energy potential exists, a national wind energy resource survey is currently under way (see reference W 82). Detailed wind surveys of Canterbury and Otago are being carried out.

## II. NEW ZEALAND WIND ENERGY TASK FORCE ACTIVITIES, 1974-1976

### A. PROJECTS SPONSORED BY THE NEW ZEALAND RESEARCH AND DEVELOPMENT COMMITTEE

#### 1. Wind energy resource survey of New Zealand (references W82, W83)

A two-year project has been authorized, with funds of \$NZ 41,000, to be carried out by Lincoln College, the University of Canterbury, Otago University and the New Zealand Meteorological Service, and is intended to:

(a) Identify advanced farm, rural and remote systems in which significant energy demands can be met by the use of wind power;

(b) Detail the specific output and operating requirements of such systems;

(c) Prepare specifications for wind-powered systems to meet such requirements.

#### 2. The utilization of wind energy (references W84, W85)

At Auckland University, with committed funds of \$NZ 25,000, an analysis is being undertaken of the technical and economic feasibility of the integration of wind power into the New Zealand electricity supply system.

### B. PROJECTS SPONSORED BY THE UNIVERSITY GRANTS COMMITTEE

#### 1. Performance characteristics of wind turbine systems for advanced farm, rural and remote use

This project is related to project A. 1. above, with additional funds of \$NZ 5,150, and has resulted in the establishment of a generalized method to predict energy output performance of typical wind turbines in

arbitrary wind regimes. Confirmation is to be obtained with an 8 kW machine, currently at an early stage of construction.

#### 2. Investigation of the rural boundary layer

This project is also related to project A. 1. above, with additional funds of \$NZ 3,400, and has resulted in the design and production of a 20-m guyed, welded steel instrumentation mast.

### C. PROJECTS SPONSORED BY THE MINISTRY OF WORKS AND DEVELOPMENT

#### 1. Wind power for Chatham Island

Funds of \$NZ 1,500 have enabled preliminary investigation to be completed.

#### 2. Wind power for Stewart Island

Funds of \$NZ 2,000 have been allocated to Lincoln College for an investigation similar to project C. 1. above.

#### 3. Water pumping on Mana Island

Funds of \$NZ 500 have been allocated to Lincoln College for a preliminary assessment of the use of wind for pumping water on the island.

### D. MISCELLANEOUS PROJECTS

#### 1. Vertical-axis windmill

A Canadian-made vertical-axis wind-electric machine is currently under test at Auckland University.

#### 2. Windmill and pump

A commercially available windmill and pump are to be installed at Lincoln College for test and demonstration purposes.

## WINDPOWER STUDIES IN KOREA (NR/ERD/EWGSW/CR.16)\*

by

Mr. Chung-Oh Lee (Republic of Korea)

In recent years, the possible utilization of wind-power has been receiving close attention in the Republic of Korea, especially for the electrification of off-shore islands. There are more than seven hundred islands around the Korean peninsula, but only a small number have electricity supply, generated by diesel-electric sets

or similar conventional methods. The meteorological data supplied by the Korean Weather Bureau indicate that these areas have dependable wind sources, and, in 1974, the Ministry of Science and Technology awarded a research grant to the Korea Advanced Institute of Science for the preliminary study, design and testing of a small experimental windpower system capable of producing 2 kW maximum continuous output.

\* Abridged.

**A. ANALYSIS OF WIND DATA**

The quantitative analysis of wind data for the previous five years provided information on the average yearly frequency of wind velocities and the monthly frequency of usable winds (see reference W 86). Based on this analysis, several islands were selected for further study. As typical examples, the average yearly frequency of wind velocities are shown in figure 1 for the stations at Cheju Island, Ulnung Island, and Chupungryung. The distribution of the hours of usable wind (velocity greater than 16 km/h) for these locations is shown in figure 2. Since the power available depends on the cube of wind velocity, the annual relative energy of wind at these locations may be shown as in figure 3, where the values assigned to the ordinate are relative.

The conclusions drawn from the analysis of records from 27 stations along the coastline were:

(a) The southern coastal area is extremely favourable for windpower systems;

(b) Winter is considered to be the most favourable season;

(c) The number of consecutive calm days never exceeds three in the southern islands.

**B. MAIN DESIGN FEATURES**

The 4-m diameter rotor consists of a three-bladed propeller in which each blade is twisted appropriately, with a fully feathering hub controlled by centrifugal weights. The special brushless generator produces 2 kW, three-phase, 400 V AC (reference W 87), which in the experimental unit was fed through a rectifier to 16 lead-acid 12 V batteries, arranged to give a storage of 1.92 kWh at 96 V. Other design and aerodynamic features are:

Maximum propeller rev/min — 200

Maximum generator rev/min — 1,000

Voltage regulation — automatic constant voltage regulation

Tower height — 12 m

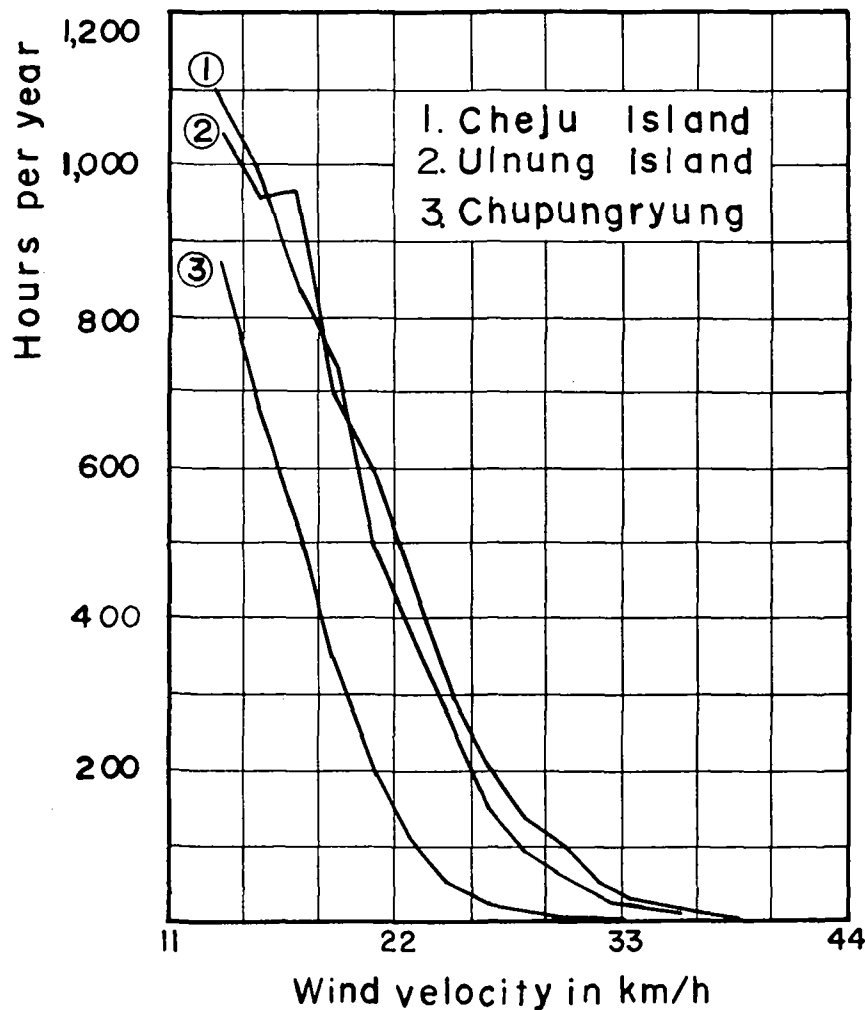

Figure 1. Wind velocity hourly duration curve

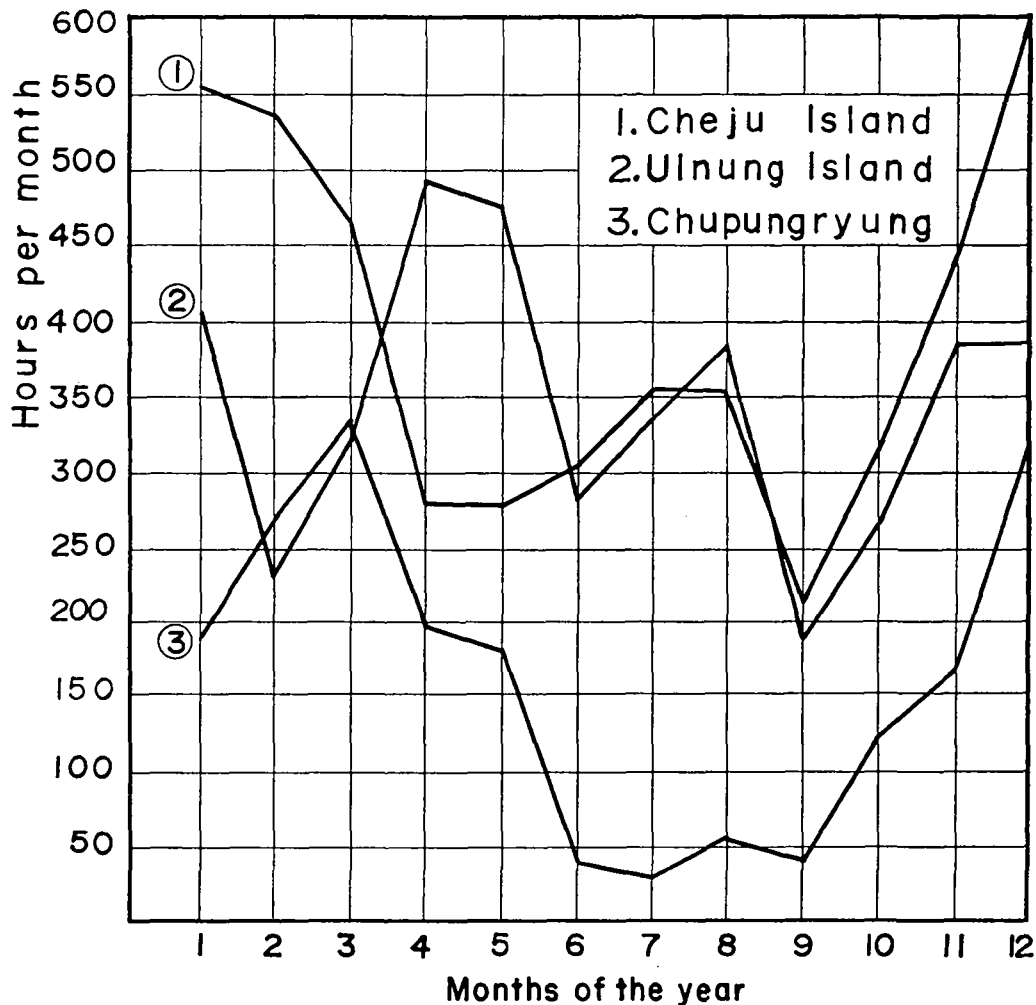

Figure 2. Monthly distribution of hours of usable wind (above 16 km/h)

Starting wind speed — 16 km/h

Maximum output wind velocity — 43 km/h

**C. INSTALLATION**

A series of laboratory tests was conducted to check the performance of the generator and the feathering hub. A test for the durability of the whole system was then undertaken in non-uniform air currents produced by a 2.5-m diameter propeller attached to a 200 hp engine (see reference W 88).

After the completion of the laboratory tests, a wind-power system was installed in February 1975 on an island in the Yellow Sea for actual testing and evaluation. Figure 4 shows the output against wind velocity as measured in the field test.

**D. REINFORCEMENT OF THE PROPELLER**

After operation of the system for three months, two blades broke and the hub was destroyed by the

resultant unbalanced torque. A thorough study of possible causes of the accident, including investigation of stress distribution in the blades, led to the design of appropriate reinforcement (see reference W 89). Blades constructed to the modified design have been operating satisfactorily since installation.

On the assumption that one of the contributory causes of the initial fracture might have been the very fast action of the feathering system, with a rapid change of stress, further work is being carried out on a possible modification in the design of the feathering system.

**E. FUTURE WORK**

Details of a follow-up project are now being prepared, the objective being to develop a reliable and cost-competitive wind energy conversion system of relatively small scale (2-5 kW) for lighting and communication purposes in off-shore islands.



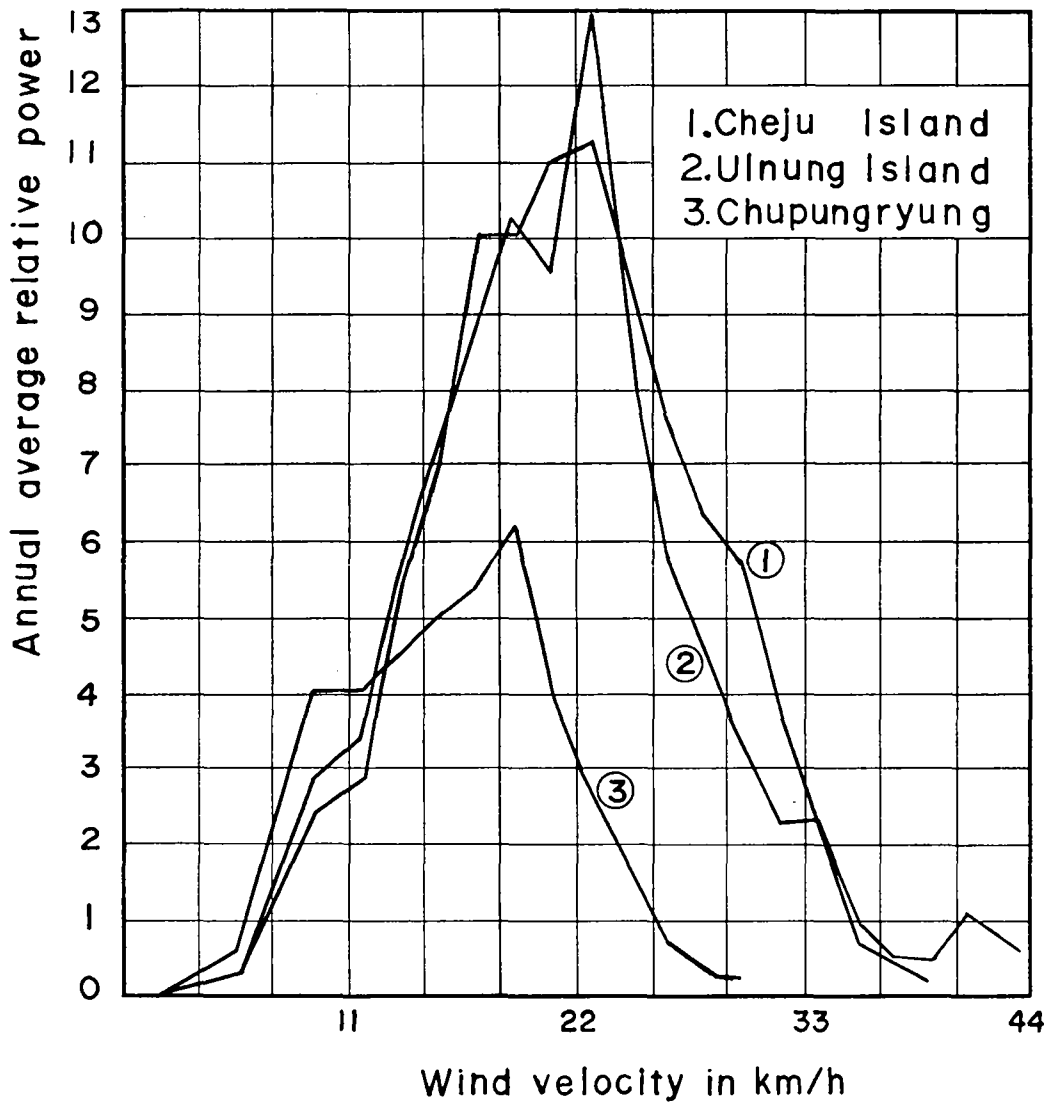

Figure 3. Relative annual energy in winds

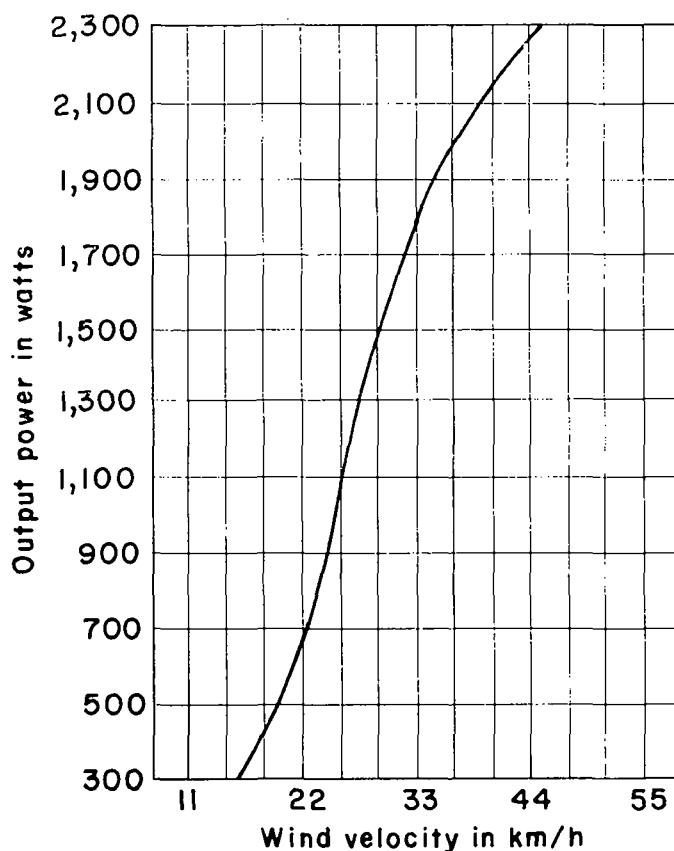

Figure 4. Output against wind velocity

**RESEARCH AND PROSPECTS OF UTILIZATION OF WIND ENERGY IN INDONESIA  
(NR/ERD/EWGSW/CR.17)\***

by

Mr. H. Djodihardjo (Indonesia)

The possible increase in wind energy utilization in Indonesia is a challenging problem (reference W 90) because:

(a) There is a scarcity of wind data, although it has been believed that Indonesia is a low-velocity wind area;

(b) There is no precedent or available expertise in Indonesia;

(c) Wind energy could be economical in the sense that foreign exchange could be saved;

(d) There has been a growing public concern to preserve the ecological balance of the environment.

**A. REVIEW OF WIND ENERGY CONVERSION SYSTEM CHARACTERISTICS**

Table 1 indicates the theoretical dependence of available energy on wind speed and rotor diameter (references W 42 and W 51). The actual power output that can be delivered to the output system that utilizes

Table 1. THEORETICAL WIND ENERGY AVAILABLE (in kW)

Wind speed in km/h	Diameter of rotor in m				
	4	6	8	10	20
9	0.070	0.157	0.280	0.437	1.748
18	0.559	1.258	2.236	3.493	13.970
27	1.887	4.246	7.548	11.790	47.180
36	4.474	10.070	17.880	27.960	111.900
45	8.738	19.660	34.950	54.610	218.500
54	15.100	33.970	60.390	94.360	377.500

\* Abridged.

the wind energy is further reduced by a power coefficient which can vary up to the order of 0.7 for the most aerodynamically efficient windmills.

Furthermore, the output system usually has an efficiency substantially less than unity (see reference W 91). The maximum over-all efficiency of the wind conversion system would be of the order of 20 to 25 per cent. Table 2 indicates the actual power output of a wind energy conversion system with over-all efficiency of 20 per cent, for different wind velocities and rotor diameters.

Table 2. TYPICAL ACTUAL MAXIMUM OUTPUT POWER AVAILABLE (in kW)

Wind speed in km/h	Diameter of rotor in m					
	2	4	6	8	10	20
7.2	0.003	0.013	0.029	0.051	0.080	0.320
9.0	0.006	0.025	0.056	0.101	0.157	0.628
10.8	0.011	0.044	0.098	0.172	0.272	1.086
12.6	0.017	0.069	0.155	0.276	0.431	1.720
14.4	0.026	0.103	0.231	0.412	0.643	2.570
18.0	0.050	0.201	0.452	0.804	1.260	5.020
21.6	0.087	0.347	0.781	1.390	2.170	8.680
28.8	0.206	0.823	1.850	3.290	5.150	20.600
36.0	0.402	1.610	3.620	6.430	10.000	40.200

It is noted that, for a typical windmill application to provide 1 kW of power, at a site with a design wind speed 18 km/h, a rotor diameter of the order of 10 m

is required. Figure 1 shows a typical spectrum of horizontal wind speed near the ground for an extensive frequency range, taken from reference W 92.

B. WIND DATA IN INDONESIA

In Indonesia, wind data, rainfall, solar radiation and other climatic factors are compiled by the Center for Meteorology and Geophysics (PMG) from measurements made by meteorological stations at most aerodromes, agricultural and maritime meteorological stations and meteorological stations of other agencies in co-operation with PMG. The Indonesian National Institute of Aeronautics and Space (LAPAN) also conducts meteorological studies, mostly for the upper atmosphere, at its premises in Bandung and Cilaut-Eureun. A sample of wind records for various selected places in Indonesia taken at an elevation about 10 m above the ground is shown in table 3.

Table 4 shows average values of wind velocities and predominant wind direction for Jakarta during the period 1961 — 1970. These data illustrate relative wind intensity prevailing at most places in Indonesia, i.e. of the order of 2 to 5 m/sec (7 to 18 km/h), although it is well understood that both the locations of observation stations and the method used are not very useful for the assessment of windpower possibilities, and higher values of wind speed may occur at other locations. From table 3, some locations like Banda Aceh, Semarang and Madiun seem to have a mean wind speed of 5 m/sec (18 km/h). It is also

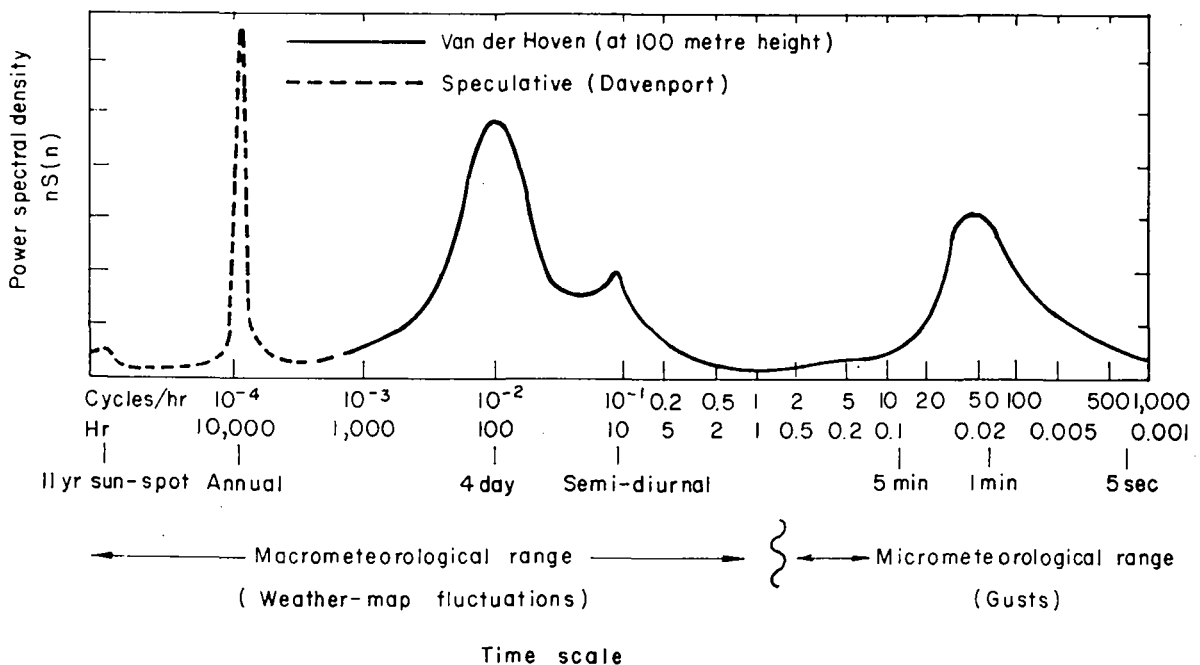

Figure 1. Spectrum of horizontal wind speed near the ground for an extensive frequency range

Table 3. SAMPLE OF WIND VELOCITY DATA IN INDONESIA, 1974  
(in km/h)

Station	Mean wind velocity												Maximum velocity
	J	F	M	A	M	J	J	A	S	O	N	D	
<b>Java:</b>													
Bandung . . . . .	17	15	13	7	6	7	7	7	9	9	9	9	40
Jakarta (H) . . . . .	11	13	11	7	7	7	6	7	7	7	7	7	58
Madiun . . . . .	28	15	17	15	19	24	28	24	28	24	24	15	53
Jakarta (K) . . . . .	9	11	7	6	7	7	7	7	7	7	7	9	41
Semarang . . . . .	22	19	19	15	15	15	13	15	15	13	11	11	41
<b>Sumatra:</b>													
Banda Acch . . . . .	15	15	13	11	11	13	15	19	15	NA	11	13	50
Bengkulu . . . . .	6	6	6	6	4	6	4	4	4	7	7	9	41
Medan . . . . .	13	13	17	13	9	11	11	9	11	11	11	NA	33
Padang . . . . .	6	9	9	7	7	7	9	7	9	9	9	6	60
Palembang . . . . .	15	13	13	9	9	9	11	11	9	9	9	9	58
Pangkalpinang . . . . .	17	13	15	11	11	15	15	17	11	13	9	9	41
<b>Nusa Tenggara:</b>													
Denpasar . . . . .	24	19	15	7	17	19	15	17	19	17	9	9	58
Pasirpanjang . . . . .	33	11	17	9	24	31	26	22	22	19	15	11	83

Table 4.

WIND VELOCITY DATA IN JAKARTA, 1961 — 1970

Month	Prevailing direction	Mean velocity (km/h)	Maximum velocity	
			(km/h)	(year)
January . . . . .	NW	5.8	47	1965
February . . . . .	NW	6.1	43	1966
March . . . . .	NW	5.4	36	1970
April . . . . .	E	5.4	41	1965
May . . . . .	E	5.8	41	1965
June . . . . .	E	5.8	41	1965
July . . . . .	E	6.5	36	1966
August . . . . .	E	6.1	36	1966
September . . . . .	N	6.5	43	1967
October . . . . .	N	6.5	50	1969
November . . . . .	N	5.4	49	1967
December . . . . .	NW	5.4	50	1970
Yearly average . . . . .	E	5.8	50	1970

known that the surface wind is intensified in flowing over mountain ridges, which can be regarded as favourable places for windmill utilization in view of the unavailability of transmitted electricity in many rural mountain regions. In order to be able to predict the possible amount of windpower, there is a need for wind distribution curves at various locations in Indonesia.

C. RESEARCH AND DEVELOPMENT

In 1968, the Department of Mechanical Engineering of the Institute of Technology, Bandung, was involved in the design and construction of a multi-vane fan type windmill (see reference W 33). The wind energy conversion system was constructed for water pumping, with rotor diameter 4.2 m, tower height 42 m, head 15 m and pump capacity 20 m<sup>3</sup>/day; and was installed at Pangarasan in central Java. The wind velocity was measured as 12 km/h while wind gust velocities could reach 40 km/h. The unit was constructed without research and developmental work, and no provision was made for feedback of technical problems which occurred.

Motivated partly by the need for conducting a more systematic effort for wind energy conversion system design, construction and utilization, a small-scale research effort was started at the Aero and Hydrodynamics Laboratory of the Institute in 1973. The work has been performed in conjunction with student projects and has been restricted by scarcity of funds and lack of supporting literature. The work was geared to small-scale wind energy conversion systems for rural areas, and the objectives were, briefly, to initiate research and development effort in this field, and to explore the development of local technology in wind energy conversion systems. Good progress has been made on an experimental study of vertical-axis (Darrieus) type rotors (figure 2), followed by design and construction of a prototype 2-blade rotor wind-

mill (reference W 93), an experimental study of a propeller type windmill model and analysis and design of a sail-type windmill (reference W 94).

The Darrieus-type windmill rotor blades were made from locally available steel, and were machined to shape at the army industrial workshop. The blades have a symmetrical aerofoil cross section to United States standard (NACA 0012), with maximum aerofoil

thickness of 3 mm and a chord length of 2.5 cm. Torque measurements were made with a simple pony-type brake with a piece of string to provide the friction for lifting a weight.

Test results on the prototype gave an output coefficient curve similar in shape to that from tests made on a large unit at the National Research Council, Canada, but the peak value was lower by about 30 per cent.

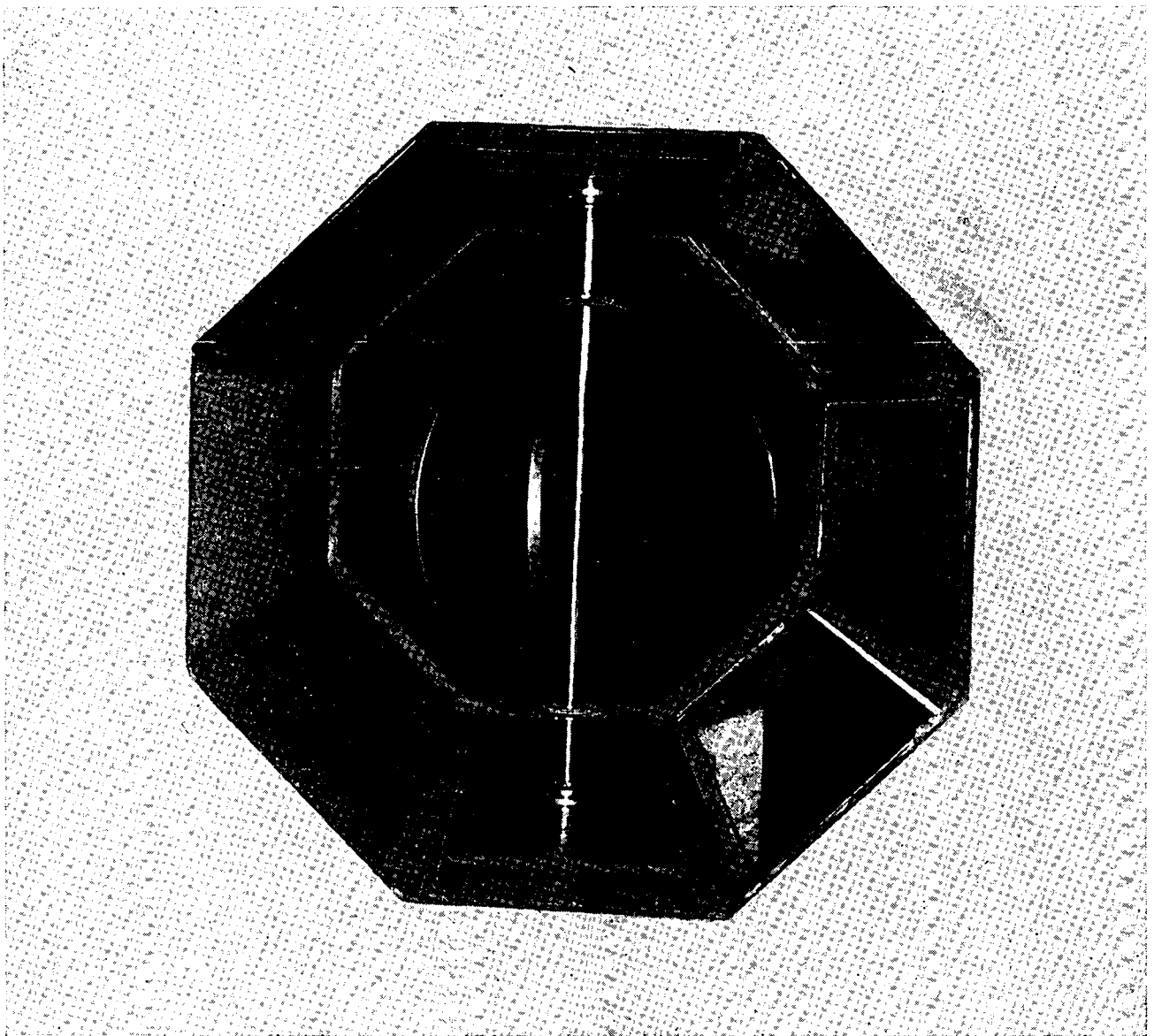

Figure 2. 3-blade Darrieus rotor model in wind tunnel

The blades for the propeller-type windmill were made of laminated wood, with a diameter of 0.7 m, a constant chord length of 0.07 m and hub diameter of 0.07 m. The pitch angle setting of the propeller blade is shown in table 5.

Table 5. BLADE THICKNESS AND ANGLE SETTING OF THE TEST PROPELLER

Radius at measuring point (cm)	Maximum thickness (cm)	Pitch angle setting (degrees)
3.5	1.12	28.4
7	1.12	18.6
10.5	0.98	15.0
14	0.98	9.2
17.5	0.70	7.0
21	0.56	7.0
24.5	0.42	5.0
28	0.42	5.0
31.5	0.42	4.9
35	0.42	4.5

The following conclusions have been drawn from the work to date:

(a) Multi-vane, propeller, sail, and Darrius types of windmills, and Savonius rotors, could be manufactured locally due to their simplicity of construction, and yet could provide suitable power output at rated wind speeds of 14 to 18 km/h.

(b) Propeller and Darrius type windmills have excellent aerodynamic efficiency at relatively high tip

velocities and would be attractive for wider application in Indonesia. Further development would be necessary in order to reduce the cost.

(c) Sail-type windmills and Savonius rotors are also attractive for wider application in rural areas.

D. POTENTIAL APPLICATIONS IN INDONESIA

The current cost of transmitted electric power in Indonesia is about 3-4 US cents/kWh, while a locally-manufactured propeller-type windmill may produce electricity at about 15 US cents/kWh, but this cost could probably be reduced by large-scale production. At present, windmills would not be economic if transmitted electric supply were available.

E. CONCLUSIONS AND RECOMMENDATIONS

Wind energy conversion systems are attractive because of their non-polluting nature, utilization of renewable energy resources, low maintenance and simplicity of operation, and could have potential applications in Indonesia, particularly for rural areas and islands.

Hardware development work should be initiated and encouraged in order that technological capabilities can be developed for local manufacture of economical, simple and efficient windmills.

### III. CONSOLIDATED LIST OF REFERENCES ON WIND ENERGY

- W 1. E. W. Golding, *The Generation of Electricity by Wind Power*, (London, E and F.N. Spon Ltd., 1955), pp. 22.
- W 2. Arthasastra of Kautilya, quoted from *Studies in Ancient Hindu Polity* by Narendra Nath.
- W 3. A. Makhijani and A. Poole, *Energy and Agriculture in the Third World*, (Cambridge, Massachusetts, USA, Ballinger, 1975).
- W 4. E. W. Golding, "Windmills for water lifting and the generation of electricity on the farm", *FAO Internal Working Bulletin* No. 17.
- W 5. "Energy from the wind — assessment of suitable winds and sites", *WMO Technical Note* No. 4, Geneva, 1954.
- W 6. Communication from J. Park, (Helion), USA.
- W 7. Calvert, 'Wind power in eastern Crete', *Transactions of the Newcomen Society*, UK, 1972, vol. XLIV, pp. 137-144.
- W 8. M. M. Sherman, "6,000 handcrafted sail wing windmills of the Lassithiou, Greece, and their relevance to windmill development in rural India", *Proceedings, Wind and Solar Energy for Water Supply*, German Foundation for International Development, Berlin, 1975.
- W 9. "Plans for 25 foot diameter sail windmill", *Windworks*, USA.
- W 10. "Performance data for 25 foot diameter sail windmill", *Brace Research Institute*, Canada.
- W 11. "Construction plans for 10 m diameter sail windmill", *TOOL Foundation*, Netherlands.
- W 12. "Note on 6 m diameter sail windmill", *Sarvodaya Educational Development Institute*, Sri Lanka.
- W 13. P. Fraenkel, "Food from windmills", *Intermediate Technology Development Group*, UK.
- W 14. F. H. King, *Farmers of Forty Centuries*, (Wisconsin, USA, Madison, 1911).
- W 15. J. Needam, *Science and Civilization in China*, (Cambridge University Press, UK, 1955), vol. 4:2, pp. 555-567.
- W 16. *Nogyne Jixie (Agricultural Machines)*, Northeastern Machinery Institute of China, Nos. 11 and 12, 1958.
- W 17. Chen Li, "Why has the windmill not been more widely used in North China? A report on the construction of the windmill (of the Salterns) used on the coast of the Gulf of Chilli (near Tientsin)", *Kho Hsueh Thung Paro (Science Correspondent)*, 1951, vol. 2, No. 3, p. 266.
- W 18. *Water Conservancy in New China*, Ministry of Water Conservancy, (Shanghai, People's Art Publishing House, 1956).
- W 19. *Nogyne Jishu (Agricultural Techniques)* China, No. 9, 1958, pp. 15-16).
- W 20. W. E. Heronemus, "A survey of the possible use of wind power in Thailand and the Philippines", *USAID*, Contract No. TA-C 1143, 1974.
- W 21. F. Stokhuyzen, *The Dutch Windmill*, (New York, Universe Books, Inc., 1963), pp. 21-46.
- W 22. R. Garcia, "Low-cost windmill", *Volunteer Technical Assistance*, USA.
- W 23. Report by the commission on the Church's participation in development, *World Council of Churches*, Switzerland.
- W 24. A. Bodek, "How to construct a cheap wind machine for pumping water", *Brace Research Institute*, Publication No. 5, Canada.
- W 25. Koslowski, "Investigation of whether a Savonius rotor is a suitable prime mover", *Intermediate Technology Development Group*, UK.
- W 26. U. Hutter, "Planning and balancing of energy of small output wind plant", *Proceedings of the Symposium on Wind and Solar Energy*, (UNESCO, October 1954), p. 85.
- W 27. *Energy Primer*, (USA, Portola Institute, 1974), pp. 74-105.
- W 28. P. Johnston, "Notes on rural electrification by windpower", report to the Ministry of Finance, *Fiji Government*, 1975.
- W 29. *Proceeding of the Second Workshop on Wind Energy Conversion Systems*, *Energy Research and Development Administration*, USA.

- W 30. *Nogyne Jishu (Agricultural techniques)*, China, No. 19, p. 11.
- W 31. M. M. Sherman, "The design and construction of an appropriate water pumping windmill for agriculture in India", *Transactions, Wind and Solar Energy for Water Supply*, German Foundation for International Development, Berlin, 1975.
- W 32. D. K. Biswas, report to the Indian Agricultural Research Institute, India.
- W 33. F. Harahap, "Design and construction of a windmill: an experience of the Mechanical Engineering Department of ITB", workshop paper, Bandung Institute of Technology, Indonesia, 1972.
- W 34. "Wind pump for lifting water", Information Kit Section II-Part B, vol. II, No. 5, USAID Technical Digest Service, Washington, USA, 1962.
- W 35. Detailed plans of Princeton sail wing rotor windmill design, (New York, Flanagan Plans).
- W 36. M. M. Sherman, "A water pumping windmill that works", *Journal II of the New Alchemists*, USA, 1973.
- W 37. H. Stam, "Adaptation of windmill designs, with special regard to the needs of the less industrialized areas", *Proceedings of United Nations Conference on New Sources of Energy*, Rome, 1961, vol. 7, paper No. W/40, pp. 347-357.
- W 38. J. Park, "Simplified wind power systems for experimenters" and "12/16 complete plans and instructions", Helion, USA.
- W 39. H. Meyer, "12 footer plans", Windworks, USA.
- W 40. R. E. Chilcott, "The design, development and testing of a low cost 10 hp windmill prime mover", Brace Research Institute, Publication No. 7, Canada, 1970.
- W 41. R. Wailes, "Horizontal windmills", *Transactions of the Newcomen Society*, London, 1967/8, vol. XL, pp. 125-145.
- W 42. P. South and R. S. Rang, "An experimental investigation of a 12 ft. diameter high speed vertical axis wind turbine", National Research Council Report LTR-LA-166, Canada, 1975.
- W 43. J. R. Godfrey, DAF Company report, Canada.
- W 44. R. V. Brulle, H. C. Lavsén, "Gyromill (cydogyro windmill) investigation for generation of electrical power", *Proceedings of the Second Workshop on Wind Energy Conversion Systems*, Mitre Corporation, Washington, USA, 1975, pp. 452-457.
- W 45. P. Bade, "Flapping vane wind machine and rod-piston pump" and "Flapping vane wind machine", *Transactions, Wind and Solar Energy for Water Supply*, German Foundation for International Development, Berlin, 1975.
- W 46. Communication from E. Barnhart, New Alchemy Institute-East, USA.
- W 47. "Water lifting for agriculture using non-conventional power equipment", Ministry of Agriculture and Co-operative, Government of Thailand, 1974.
- W 48. S. Wilson, "Note on low lift irrigation pumping", Department of Engineering Science, Oxford University, UK.
- W 49. R. L. Pendleton, *Thailand, Aspects of Landscape and Life—An American Geographic Society Handbook*, (New York, Duell, Sloan and Pearce, 1963).
- W 50. I. A. Rubinski and A. I. Rubinsky, "A low specific speed pump for small discharges", *Civil Engineering and Public Works Review*, vol. 50, No. 591, September 1955, pp. 987-990.
- W 51. M. F. Merriam, *Wind Energy for Human Needs*, (UC 1 D—3724), (Berkeley, California, USA, Lawrence Berkeley Laboratory, 1974).
- W 52. "Review of progress on utilization of wind power", National Aeronautical Laboratory, India, Report No. SR-WP-1-60, 1960.
- W 53. S. P. Venkiteswaran, "Operation of Allgaier type wind electric generator at Porbandar", National Aeronautical Laboratory, India, Report No. TN-WP-2-61, 1961.
- W 54. R. Ramanathan and S. Viswanath, "Estimated annual energy output of two types of wind electric generators at selected stations in India", National Aeronautical Laboratory, India, Report No. TN-WP-4-62, 1962.
- W 55. S. P. Venkiteswaran, K. R. Silvaraman and C. G. Gupte, "A note on the feasibility of wind generation of electric power for communication links in India", National Aeronautical Laboratory, India, Report No. TN-WP-36-65, 1965.



- W 56. S. K. Tewari and L. S. Srinath, "A systems approach towards utilization of wind energy (a preliminary study)", National Aeronautical Laboratory, India, 1975.
- W 57. S. Janardhan, "Some preliminary considerations in the choice of rated speeds for wind machines", National Aeronautical Laboratory, India, Report No. TN-WP-20-63, 1963.
- W 58. E. W. Golding, Electrical Research Association, UK, Report No. C/T 118, 1956.
- W 59. P. Nilakantan, K. P. Ramakrishnan and S. P. Venkiteswaran, "Windmill types considered for large scale use in India", National Aeronautical Laboratory, India, Report No. TN-WP-3-61, 1961.
- W 60. K. R. Silvaraman and S. P. Venkiteswaran, "Utilization of wind power for irrigation of crops in India with special reference to the distribution of wind and rainfall", National Aeronautical Laboratory, India, Report No. TN-WP-30-63, 1963.
- W 61. S. P. Venkiteswaran and K. R. Silvaraman, "Utilization of wind power in arid and semi-arid areas in India", National Aeronautical Laboratory, India, Report No. TN-WP-35-64, 1964.
- W 62. S. K. Tewari, "How feasible is the substantial utilization of wind power in India?", National Aeronautical Laboratory, India, 1975.
- W 63. S. K. Tewari, "It's time to talk about wind power", *Science Today*, November 1975.
- W 64. P. N. Shankar, "The design, fabrication and preliminary testing of NAL'S 1 kW vertical axis wind turbine", National Aeronautical Laboratory, India, Report No. AE-TM-22-75, 1975.
- W 65. P. N. Shankar, "On the aerodynamic performance of a class of vertical axis windmills", National Aeronautical Laboratory, India, Report No. AE-TM-13-75, 1975.
- W 66. *BHEL Research and Development News*, Second Annual Day Issue, January, 1976.
- W 67. J. O'M. Bockris, "The case for sea-borne wind-based power", *Search*, July 1975.
- W 68. "The role of research and development in New Zealand's energy economy", Department of Scientific and Industrial Research, New Zealand, March 1974.
- W 69. R. F. Benseman and F. W. Cook, "Solar radiation in New Zealand — the standard year and radiation on inclined slopes", *New Zealand Journal of Science*, No. 12, December 1969, pp. 696-708.
- W 70. H. I. Odum, *Environment, Power and Society*, (New York, Wiley Interscience, 1971).
- W 71. *Proceedings of the Second New Zealand Energy Conference*, University of Canterbury, New Zealand, May 1975.
- W 72. G. C. Szego and C. C. Kemp, "Energy Forests and Fuel Plantations", *Chemical Technology*, May 1973, pp. 275-284.
- W 73. E. Flatteau and J. Stansbury, "It takes energy to produce energy: the net's the thing", *Washington Monthly*, March 1974, pp. 20-26, and "Net Energy", April 1974, p. 6.
- W 74. N. Geogescu--Roegen, "Energy and economic myths", *Southern Economic Journal*, vol. 41, January 1975, pp. 347-381.
- W 75. J. G. R. Stevens, "Energy and agriculture", *Span* (Shell Oil Company), vol. 18, No. 1, 1975.
- W 76. M. Slessor, "How many can we feed?", *Ecologist*, 3, 1973, pp. 216-220.
- W 77. "Solar water heaters", *Consumer*, New Zealand, No. 114, January-February 1975, pp. 16-19.
- W 78. D. A. Hills and G. L. Allen, "Solar water heating", Department of Scientific and Industrial Research, New Zealand (Christchurch), Technical Bulletin No. 1 (revised edition), June 1975.
- W 79. "The status of solar energy utilization in Australia for industrial, commercial and domestic purposes", Commonwealth Scientific and Industrial Research Organization, Australia, Solar Studies Report No. 74/1, 1974.
- W 80. *Proceedings of the New Zealand Energy Conference*, University of Auckland, New Zealand, May 1974.
- W 81. J. van Meighem, *Atmospheric Energetics*, Oxford, 1973.
- W 82. N. J. Cherry, "Preliminary analysis of meteorological data", Lincoln College, Canterbury, New Zealand, Report No. WER-1, 1975.

- W 83. N. J. Cherry, D. J. Edwards and A. J. Roxburgh, "Low-cost instrumentation for a wind energy survey", paper to be presented at the 22nd International Instrumentation Symposium, San Diego, California, USA, May 1976.
- W 84. J. R. Wood, "Wind energy utilization in New Zealand", University of Auckland, New Zealand, 1975.
- W 85. D. Lindley, "New Zealand's place in the energy economics of the Pacific basin countries", Conference on Energy in the Pacific Basin, Pepperdine University, California, USA, December 1975.
- W 86. C. O. Lee, "Study on windpower utilization as a source of energy", Ministry of Science and Technology, Republic of Korea, Report No. STF-74-2, 1974.
- W 87. K. Z. Cho, "Performance analysis of a self-excited brushless generator", Korea Advanced Institute of Science, M. S. thesis, 1976.
- W 88. H. V. O, "Frame analysis of structural design system", Korea Advanced Institute of Science, M. S. thesis, 1976.
- W 89. T. S. Ahn, "Stress analysis of a windmill propeller", Korea Advanced Institute of Science, M. S. thesis, 1976.
- W 90. A. Arismunandar, "The Indonesian energy demand in the year 2000: views and comments", *Symposium on Energy and the Environment*, Jakarta, Indonesia, February 1975.
- W 91. D. J. Grace and others, Report of the Task Force on wind energy, *Alternate Energy Sources for Hawaii, 1975*, Hawaii Natural Energy Institute, February 1975.
- W 92. D. E. Walshe, *Wind Excited Oscillations of Structures*, London, H. M. S. O., 1972.
- W 93. Asyaman, Final project, Department of Engineering Physics, Bandung Institute of Technology, Indonesia, 1976.
- W 94. R. Rosad, Final project, Department of Mechanical Engineering, Bandung Institute of Technology, Indonesia, 1976.
- Other useful references*
- R. van Steyn, *Wind Energy, A Bibliography with Abstracts and Keywords, Parts I and II*, Department of Physics, Eindhoven University, Netherlands.
- Wind Energy Utilization, a Bibliography with Abstracts*, National Aeronautical and Space Administration, USA, 1974.
- Wind Energy Bibliography* (USA, Windworks).
- Wind Power*, (J. G. Symons, Mankato, Minnesota, USA).
- Wind Powered Machines*, (USA, National Technical Information Service).
- T. Savino, *Wind Energy Conversion Systems, Workshop Proceedings*, Washington, D.C., June 1973, (USA, National Technical Information Service).
- T. Savino, *Status of Wind Energy Conversion*, (USA, National Technical Information Service).
- Soedergard, *Analysis of Possible Use of Wind Power in Sweden*, part I, Resources, Theory, Model 1 and 10 MW, (USA, National Technical Information Service).
- Christaller, "Exploitation of wind energy", parts I and II, National Technical Information Service, USA.
- U. Hutter, "The development of wind power installations for electrical power generation in Germany", National Technical Information Service, USA.
- Bettlgnies, "Wind energy — its utilization in isolated areas of the Americas, ½ - 100 kW", Northern Engineering Centre, Ecole Polytechnique, Montreal, Canada.
- M. F. Merriam, "Is there a place for the windmill in less developed countries", Working Paper Series No. 20, East West Centre, Honolulu, Hawaii, USA.
- G. Smith, "List of manufacturers of water pumping and electric generating windmills", School of Architecture, Technical Research Division, Cambridge, UK.

## IV. ORGANIZATIONS CONCERNED WITH WIND ENERGY

(Preliminary List)

<i>Organization</i>	<i>Officer concerned</i>	<i>Fields of work</i>
<i>A. Research Centres in the ESCAP Region</i>		
<i>1. Australia</i>		
Flinders University, Bedford Park, South Australia 5042	—	Wind generators
<i>2. Fiji</i>		
Central Planning Office, Energy Unit, Government Buildings, P.O. Box 2351, Suva	P. Johnston	Wind generators, integrated systems
<i>3. India</i>		
Ministry of Industry and Civil Supplies Appropriate Technology Cell, 268 Udyog Bharan, New Delhi-1	B. Behari	Promotion
National Council of Science and Technology, Technology Bharan, New Mehrauli Road, New Delhi	C. S. Chatterjee	Research co-ordination
National Aeronautical Laboratory, Post Bag 1779, Bangalore, Karnataka, 560017	S. K. Tewari	Wind generators, wind pumps, Darrieus rotor
Indian Institute of Science, Cell for the Application of Science and Technology to Rural Areas, Bangalore, Karnataka, 560012	A. K. N. Reddy	Vertical-axis rotors, integrated systems
Indian Agricultural Research Institute, Agricultural Engineering Division, Dairy Road, New Delhi 110012	D. K. Biswas	Greek sail rotor, Savonius rotor
Central Arid Zone Research Institute, Wind and Solar Division, Jodhpur	A. Krishnan	Data analysis
Auroville Centre for Environmental Studies, Pondicherry-2, 605001	C. L. Gupta	Low-cost windmills, integrated systems
Organization of the Rural Poor, Kosumihkalan, P.O. Madnahi Urf Pahonehi, Ghazipur District, Uttar Pradesh	H. Prasad	Renewable energy systems
Social Work and Research Centre, Tilonia, Admer District, Rajasthan	S. Roy	Multi-use sail rotor
<i>4. Indonesia</i>		
Bandung Institute of Technology, Aero and Hydrodynamic Laboratory, Bandung	H. Djojodihardjo	Darrieus rotor, sail rotor water pump
<i>5. Malaysia</i>		
Malaysian Agricultural Research and Development Institute, P.O. Box 208, Sungai Besi, Serdang, Selangor	—	Sail rotor, peristaltic pump
<i>6. New Zealand</i>		
Lincoln College, Department of Mechanical Engineering, Canterbury	R. E. Chilcott	Wind generators, low-cost anemograph
Auckland University, Department of Mechanical Engineering, Auckland	J. R. Wood	Large-scale wind generators
<i>7. Philippines</i>		
International Rice Research Institute, Agricultural Engineering Department, P.O. Box 933, Los Banos, Manila	A. Khan	Savonius rotor
<i>8. Republic of Korea</i>		
Korea Advanced Institute of Science, Department of Mechanical Engineering, P.O. Box 150, Cheong-Ryang-Ri, Seoul	Chung-Oh Lee	Wind generator

	<i>Organization</i>	<i>Officer concerned</i>	<i>Fields of work</i>
9.	<i>Sri Lanka</i>		
	Ministry of Irrigation, Power and Highways, Secretariat Building, Colombo 1	A. D. N. Fernando	Development programme
	Sarvodaya Educational Development Institute, Appropriate Technology Project, 77 De Soysa Road, Moratuwa	A. J. Ariyaratne	Low-cost wind pumps and demonstration
10.	<i>Thailand</i>		
	National Energy Administration, Design and Energy Research Section, Pibultham Villa, Kasatsuke Bridge, Bangkok	S. Chantavorapop	Development programme, wind generator
	Ministry of Agriculture and Co-operative, Agricultural Engineering Division, Kasetsart University Grounds, Bangkok 9	C. Sukri	Low-cost wind pumps development and demonstration
<b>B. Other Organizations</b>			
1.	<i>Canada</i>		
	Brace Research Institute, MacDonald College of McGill University, P.O.B. 900, St. Anne de Bellevue 800, Quebec H9x 3M1	T. Lawand	Consultancy services, research for developing countries
	National Research Council, Low Speed Aerodynamics Laboratory, Montreal Road, Ottawa K1H 6R6	R. J. Templin	Darrieus rotor
2.	<i>Denmark</i>		
	Folketeknik, Christiansmindeus 11, Copenhagen 2100	E. Haunerik	Low-cost windmills
3.	<i>Ethiopia</i>		
	Christian Relief and Development Association, P.O. Box 5674, Addis Ababa	E. Ressler	Low-cost windmills
4.	<i>Federal Republic of Germany</i>		
	Scientific Research Institute for Wind Energy Technique, Institute of Applied Science, University of Stuttgart, E.U., Pfaffenwaldring 31, D-7000 Stuttgart 80	U. Hutter	Research on windmills
	Technical University of Berlin, Institut für Wasserbau und Wasserwirtschaft, Straße des 17. Juni 135, D-1000, Berlin 12	P. Bade	Flapping-vane wind pump
5.	<i>Netherlands</i>		
	Eindhoven Technical University, Steering Group, Wind Energy for Developing Countries (Physics Department), Postbox 513, Eindhoven 1076326	P. T. Smulders	Comprehensive development programme
	TOOL Foundation, Postbox 525, Eindhoven	T. de Wilde	Wind pumps, advisory service
	T.N.O. Project Group Turbine Machines, P.O. Box 496, Delft	P. van Staveren	Co-ordination, optimization
6.	<i>Niger</i>		
	International Institute of Tropical Agriculture, P.M.B. 5320, Ibadan	R. Wijewardene	Integrated systems
7.	<i>Switzerland</i>		
	World Council of Churches, Commission of the Church's Participation in Development, 150 Route de ferney, P.O. Box 66, 1211 Geneva 20	P. de Pury	Low-cost windmills
8.	<i>Syria</i>		
	General Administration for the Development of the Euphrates Basin, Daria, Ragga	W. Khalayhi	Wind pumps
9.	<i>Tanzania</i>		
	Ministry of Lands, Settlement and Water Development, Water Development and Irrigation Division, P.O. Box 3030, Arusha	R. Stamley	Cambered flat plate rotor, UNICEF demonstration

Organization	Officer concerned	Fields of work
<b>10. United Kingdom</b>		
Electrical Research Association, Power Engineering Division, Cleeve Road, Leatherhead, Surrey KT 227 SA	M. E. Hadlow	Co-ordination for United Kingdom, technical publications
Intermediate Technology Development Group Ltd., Parnell House, 25 Wilton Road, London SW1 1JS	P. Fraenkel	Wind pumps, advisory service
Oxford University, Department of Engineering Science, Parks Road, Oxford, OXI 3PJ	S. S. Wilson	Sail windmill, low-cost wind pumps
University of Liverpool, Department of Mechanical Engineering, Liverpool 3	N. G. Calvert	Aerodynamic studies
Royal College of Art, School of Industrial Design, Kensington, London SW7 2EV	D. Taylor	Low-cost windmill design and demonstration
Oxford Committee for Famine Relief, 274 Banbury Road, Oxford OX2 7OZ	A. Pacey	Advisory services
<b>11. United States of America</b>		
Energy Research and Development Administration, Wind Energy Conversion Branch, 1800 6th Street, Washington, D.C. 20545	L. V. Divone	Co-ordination for USA
Technical Assistance Information Clearing House, 200 Park Avenue South, New York, N.Y. 10003	J. M. Meskill	Technical information
Department of State, Agency for International Development, Office of Science and Technology, Washington, D.C. 20523	H. A. Arnold	Technical assistance
Wind Energy Society of America, 1700 East Walnut, Pasadena, California 91106	—	High-speed rotor aerodynamics, system optimization
Alternative Sources of Energy, Route 2, Box 90-A, Milaca, Minnesota 56353	D. Marier	Intermediate technology, advisory service
New Alchemy Institute—East, Box 432, Woods Hole, Massachusetts 02543	J. Todd	Low-cost windmills, integrated systems
Princeton University, Flight Concepts Laboratory, Princeton, New Jersey 08540	T. E. Swcency	Rotor research
University of Massachusetts, Department of Civil Engineering, Amherst, Massachusetts 01002	W. E. Heronemus	Large-scale wind generators
Oklahoma State University, School of Electrical Engineering, South Stillwater, Oklahoma 74074	W. L. Hughes	Wind-electric systems
Volunteers in Technical Assistance, 3706 Rhode Island Avenue, Mt. Rainier, Maryland 20822	R. Garcia	Technical consultation service
Volunteers in Asia Inc., Appropriate Technology Project, Box 4543, Stanford, California 94305	K. Darrow	Technical assistance
<b>12. Upper Volta</b>		
L'École Inter-États d'Ingénieurs de l'Équipement Rural, B.P. 7023, Ouagadougou	—	Low-cost windmill demonstration
<b>13. United Nations</b>		
Centre for Natural Resources, Energy and Transport, Department of Economic and Social Affairs, New York, N.Y., USA	—	Advisory service
Economic and Social Commission for Asia and the Pacific, Natural Resources Division, United Nations Building, Bangkok, Thailand	A. I. McCutchan	Regional co-ordination (expert working group, 1976; roving seminar, 1977)
Economic Commission for Africa, Nairobi, Kenya		Second African meeting on energy, 1976
Food and Agriculture Organization of the United Nations, Agricultural Services Division, Via delle terme di Cavacalla, 00100, Rome, Italy	W. J. Van Gilst	Publications
United Nations Environment Programme, P.O. Box 20, Grand Central Station, New York, N.Y. 10017, USA	J. H. Usmani	Demonstration centres

---

<i>Organization</i>	<i>Officer concerned</i>	<i>Fields of work</i>
United Nations Industrial Development Organization, Salingerasse 40, A-1190, Vienna, Austria	M. Dellos	Programmes related to energy
United Nations International Childrens Emergency Fund, Food Engineering and Technology Section, 866 United Nations Plaza, New York, N.Y. 10017, USA	A. Robinson	Demonstration unit (Nairobi, June 1976)
United Nations Educational, Scientific and Cultural Organization, New York, N.Y., USA	—	Supports non-conventional energy activities
United Nations Office for Science and Technology, United Nations Plaza, New York, N.Y. 10017, USA	B. Chatel	Co-ordination
United Nations Development Programme, United Nations Plaza, New York, N.Y. 10017, USA	J. Sellew	Planning and funding
United Nations Development Programme, 200 Park Avenue, Suite 303, East New York, N.Y. 10017, USA	B. P. Kelly	Wind-electric, Paraguay

**Part Four**

**DOCUMENTATION ON INTEGRATED SYSTEMS**

## I. WORKING PAPER PRESENTED BY THE SECRETARIAT

### AN INTRODUCTION TO INTEGRATED SOLAR-WIND SYSTEMS (NR/ERD/EWGSW/4)\*

#### INTRODUCTION

Many rural villages in Asia cannot be integrated effectively within the larger regional or national systems because of the economic limitations on energy distribution. In order to increase the net productivity of these villages, it is desirable to increase the net energy available by increased and more effective use of all local energy resources, including solar energy and wind energy.

Diversity of energy sources is desirable because each source is available in a form that is compatible with certain tasks only, and some energy sources are available only for limited periods and/or on an intermittent basis. An integrated energy system may use a combination of different local sources at different times for different uses, in order to satisfy the total energy requirements of the village.

The careful addition of appropriate solar energy and wind energy conversion devices to an integrated energy system can increase the net productivity of a village in three ways: (a) the total amount of productive energy available may be increased without necessarily causing an increase in the flow of capital and operating funds out of the system; (b) traditional sources may be freed from some unsuitable tasks; and (c) new uses of energy may become practicable. Table 1, taken from reference T 1, indicates the applicability of renewable resources of energy in rural communities.

#### A. SOLAR AND WIND ENERGY— COMBINED USES

Several production processes may use a combination of solar energy and wind energy.

##### 1. Salt production

Salt production by solar evaporation of sea water is an ancient process. Thirty-six m<sup>3</sup> of sea water are required for every metric ton of common salt produced, and a considerable amount of low-lift pumping is required at each of the three stages of the process. Wind-powered pumping performs this job admirably in many countries, as in exposed coastal areas, where salt farms are located, wind velocity is invariably high.

\* Prepared by Mr. R. L. Datta and Mr. M. M. Sherman, consultants on solar energy and wind energy respectively, at the request of the ESCAP secretariat. The views expressed in this paper are the authors' own and do not necessarily reflect those of the secretariat or the United Nations.

In many instances, salt crystals/lumps must be crushed, reduced in size and washed, and a wind-powered mill may be used for this purpose. In some salt farm areas in different countries, solar distillation is used to produce fresh drinking water from sea water, and wind pumping may be used for distribution.

##### 2. Solar drying chambers

In solar drying chambers, utilization of windmills has been considered for creating the necessary draught as an alternative to solar chimneys or electric blowers. Processes for seasoning of wood and solar drying of food are being developed in the United States of America, Australia and India, and mechanical power from windmills is being used for air circulation.

Although windmills are effective in areas with a wind velocity of 10 km/h or more, wind funnels operate with a wind velocity of 6.5 km/h, and there may be applications in which the wind funnel's potentiality to increase the velocity of air flow with reduction in duct size could be useful.

##### 3. Rural electricity supply

A combination of wind and solar energy has some potential for rural electric supply. A 500 kW power system for electricity supply to small communities in the Philippines is suggested in reference T 2, consisting of three elements: (a) two three-blade high-speed rotors to drive a 500 kW three-phase constant frequency AC generator; (b) a boiler, designed to burn municipal garbage, supplying steam to an auxiliary 375 kW turbine generator during the night or when the wind generator is operating below rated capacity; (c) solar concentrators to focus the sun's rays on a 200 kW solar boiler, co-ordinated with the garbage-fueled boiler for economic parallel supply of steam to the auxiliary turbine generator. It was estimated that this tri-energy system might produce electric energy at about half the cost of an equivalent isolated diesel-fuelled generator.

##### 4. Solar housing design

In several industrialized countries, complex solar housing systems are being developed, which use solar energy for water heating, cooking, space heating and cooling. Integration of wind energy devices could make the over-all system more versatile by providing power for water pumping, refrigeration, lighting, and small appliances.



**Table 1. ENERGY DEMANDS OF RURAL COMMUNITIES AND THEIR POTENTIAL SUPPLY FROM RENEWABLE ENERGY SOURCES**

Energy use	Time requirements	Energy supply		Solar-wind-methane energy storage
		Traditional	Solar-wind-methane potential	
<i>Domestic</i>				
Water heating . . . . .	Daily	Wood, cowdung	Solar	Insulated tank
Cooking . . . . .	Precise daily	Wood, cowdung	Solar, methane	Gas holder
Lighting . . . . .	Precise nightly	—	Wind-electric, methane	Battery, gas holder
Water supply . . . . .	Constant	Human	Wind, solar	Tank
<i>Agriculture</i>				
Ploughing . . . . .	Precise seasonal	Human, animal	Wind	—
Sowing . . . . .	Precise seasonal	Human	—	—
Cultivation . . . . .	Precise seasonal	Human, animal	—	—
Harvesting . . . . .	Precise seasonal	Human	—	—
Threshing . . . . .	Precise seasonal	Human, animal	Wind	—
Winnowing . . . . .	Precise seasonal	Human	Wind	—
Drying . . . . .	Precise seasonal	Solar	Solar, wind	—
Grinding . . . . .	Random daily	Human, animal, wind, water	Wind	—
Crushing . . . . .	Precise seasonal	Human, animal, wind	Wind	—
Water pumping . . . . .	Precise seasonal	Human, animal, wind, water	Wind, solar	Reservoir
Aquaculture . . . . .	Constant	Human	Wind, solar	Reservoir
<i>Community development</i>				
Communication and education	Precise daily	—	Wind, solar (electric)	Battery
Transport . . . . .	Precise daily	Human, animal	—	—
Housing . . . . .	Seasonal	Human	Solar design	Solar wall
Refrigeration . . . . .	Constant	—	Solar, wind-electric	Battery
Salt production . . . . .	Random	Solar, wind	Solar, wind	Reservoir
Entertainment (radio, television, cinema) . . . . .	Precise daily	Human	Wind, solar (electric)	Battery

**B. INTEGRATED BIO-ENERGETIC ECOSYSTEMS**

Several experimental projects aimed at the development of integrated food-producing ecosystems incorporating intensive agriculture and aquaculture techniques with solar energy and wind energy supplies have recently been undertaken. The continuing increase of activity in this field indicates a significant future for bio-energetic ecosystems in economical food production.

**1. Asian polyculture**

Unlike modern Western agriculture, Asian agricultural production is typified by polyculture, diverse kinds of useful plants and animals living together with men in ecologically balanced and stable communities (see references T 3, T 4 and figure 1).

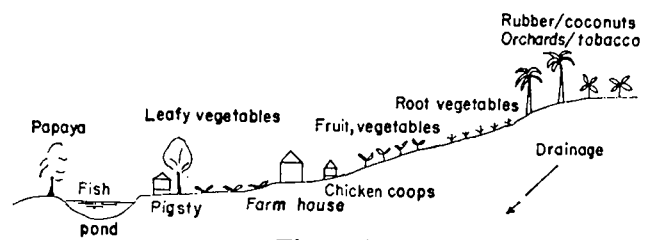

**Figure 1.**  
Integrated agriculture-aquaculture system in Singapore

The stability and productivity of these classic agricultural-aquacultural systems can be increased by providing more energy input from solar energy and wind energy. This bio-energetic farming concept has been practically demonstrated at the University of the Philippines (reference T 5) where an experiment incorporated several biological and energy subsystems integrated on a total area of 164 m<sup>2</sup> (see figure 2).

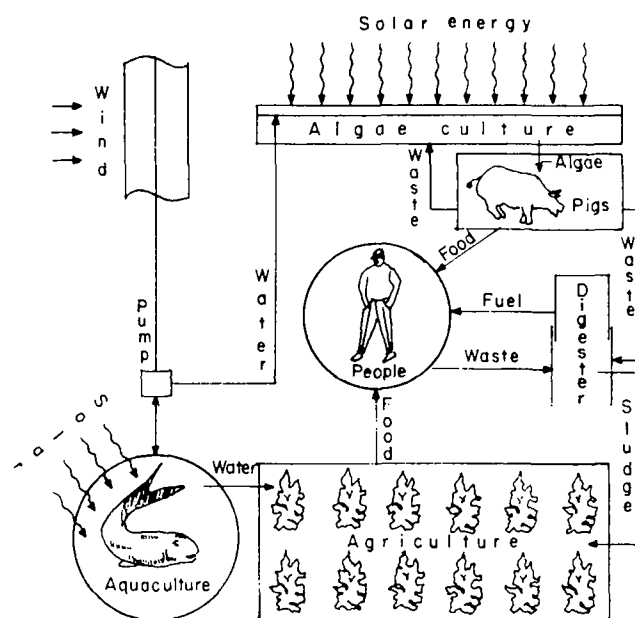

Figure 2.

University of the Philippines integrated farming system

(a) Ten pigs to produce meat for human consumption were each confined in a 4.5-m<sup>2</sup> pen. Dried and ground hog manure was obtained as the basic nutrient supply for *Chlorella* algae culture, and hog manure was supplied to digesters;

(b) A *Chlorella* algae culture pond of 20 m<sup>2</sup> was constructed on top of the pig pens to supply a food supplement to the pigs, food for tilapia fish and garden fertilizer;

(c) A methane gas generator, incorporating two digesters and a 2.5-m<sup>3</sup> gas holder, was located near the pig pens. The effluent of the digesters was available as garden fertilizer;

(d) A tilapia fish culture pond of 12 m<sup>2</sup> was added to provide storage of water required for the algae culture. Water from the fish pond was found to have high value as garden fertilizer;

(e) A vegetable garden of 54 m<sup>2</sup> was planted with lettuce, tomatoes and *pechay* and used for a controlled study of different fertilizers;

(f) A Savonius rotor wind pump was used to provide intermittent stirring of the algae culture and to pump water from the fish culture pond to the algae culture pond.

It was concluded that, by using such a scheme of integrated farming, food and fuel can be produced efficiently at a low operating cost.

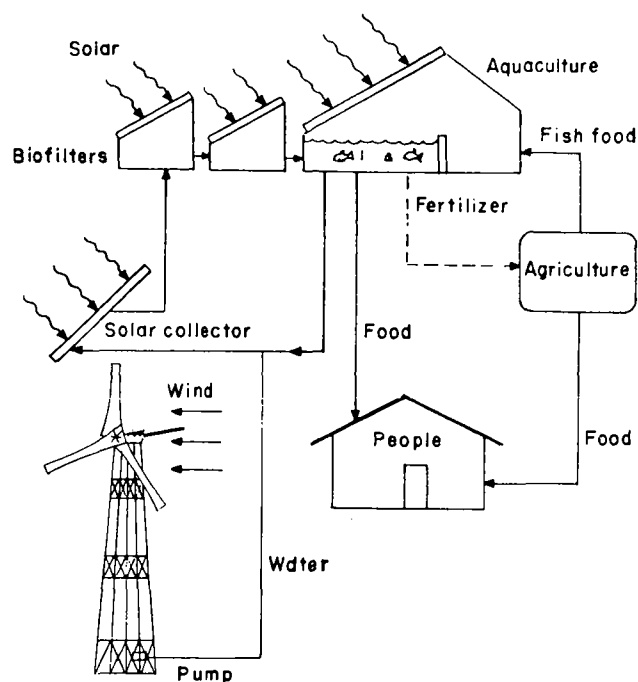

Figure 3.

New Alchemy Institute integrated backyard fish farm

## 2. New Alchemy Institute

The New Alchemy Institute, in the United States of America, has a programme of experiments to different integrated food-producing systems geared to the needs of families and small communities. The systems are modelled after Asian polyculture farms, but are adapted to northern temperature climates. One system, a backyard fish farm (see figure 3), is primarily an intensive fish-culture system incorporating: (a) 22,000-litre tilapia fish culture pool (first stage) supplied with *Daphnia* grown in a second stage and with vegetable wastes from the adjacent garden, while a biological filter (third stage) removes harmful fish wastes; (b) insulated translucent covers over all three stages retain solar heat, and the pond water is circulated through a large flat-plate solar collector to provide additional heating; (c) a windmill constructed of locally available materials circulates water through the solar heater and three pools; and (d) enclosed within the translucent greenhouse, adjacent to the primary culture pool, is an area for year-round cultivation of salad vegetables.

The research group has also recently developed a solar pond concept that integrates solar energy collection and storage, algae culture and fish culture in individual cylindrical translucent fibre-glass pools, 1.5 m high and 1.5 m diameter. Planktonic algae collect solar energy for their own growth, and at the same time heat the water. The algae are eaten by

tilapia fish. An air compressor powered by a Savonius rotor provides intermittent circulation of the water through biologically active sub-sand filters to metabolize fish wastes into nutrients for algae growth. Algae production in these solar ponds is ten times greater than in the backyard fish farm system. Forty of these ponds will be used in the Canadian Ark, which is under construction at Prince Edward Island, Canada, as a project of the United Nations Human Settlements Year.

The Ark has been designed as a completely autonomous and self-controlled system for living, research and food production. This system will incorporate: (a) an aquaculture component (the 40 solar ponds) for protein production; (b) a greenhouse section for year-round vegetable production; (c) large solar collectors for heating all components of the system; and (d) a 25 kW wind-electric generating system for supply to lights, small appliances, system control devices and scientific recording instruments, and to provide supplemental heat during the windy winter season.

### 3. Solar aquafarms

A private company (Solar Aquafarms) in the United States of America has developed a greenhouse aquaculture system intended to supply the animal protein needs of a large number of people (see reference T 6). The semi-cylindrical 30-m x 9-m insulated plastic

greenhouse incorporates solar water heaters in its walls. A wind-electric generator supplies power for water pumping. Aquaculture tanks inside the structure house giant Malaysian freshwater prawns (*Macrobrachium Rosenbergi*), common carp, freshwater clams and *Daphnia* in proper proportions so that there is a balanced food chain established with a minimum of wastes in the system. Vegetables growing in hydroponic tanks utilize the animals' metabolic wastes as their growth nutrients (see figure 4).

### 4. Centre for Maximum Potential Building Systems

The Centre for Maximum Potential Building Systems at Texas University, United States of America, has constructed several integrated living systems incorporating wind pumping, wind-electric generation, solar water-heaters, solar heating walls, methane gas generation, algae culture and intensive agriculture. The Centre conducts research into the design potentials of economical integrated housing systems (see figure 5).

### 5. Integrated Living Systems

Integrated Living Systems, in Tijeras, New Mexico, United States of America, is a research laboratory that has successfully integrated solar collectors and wind-electric generators into autonomous living units. The systems are designed for autonomous communities independent of outside energy supplies (see figure 6).

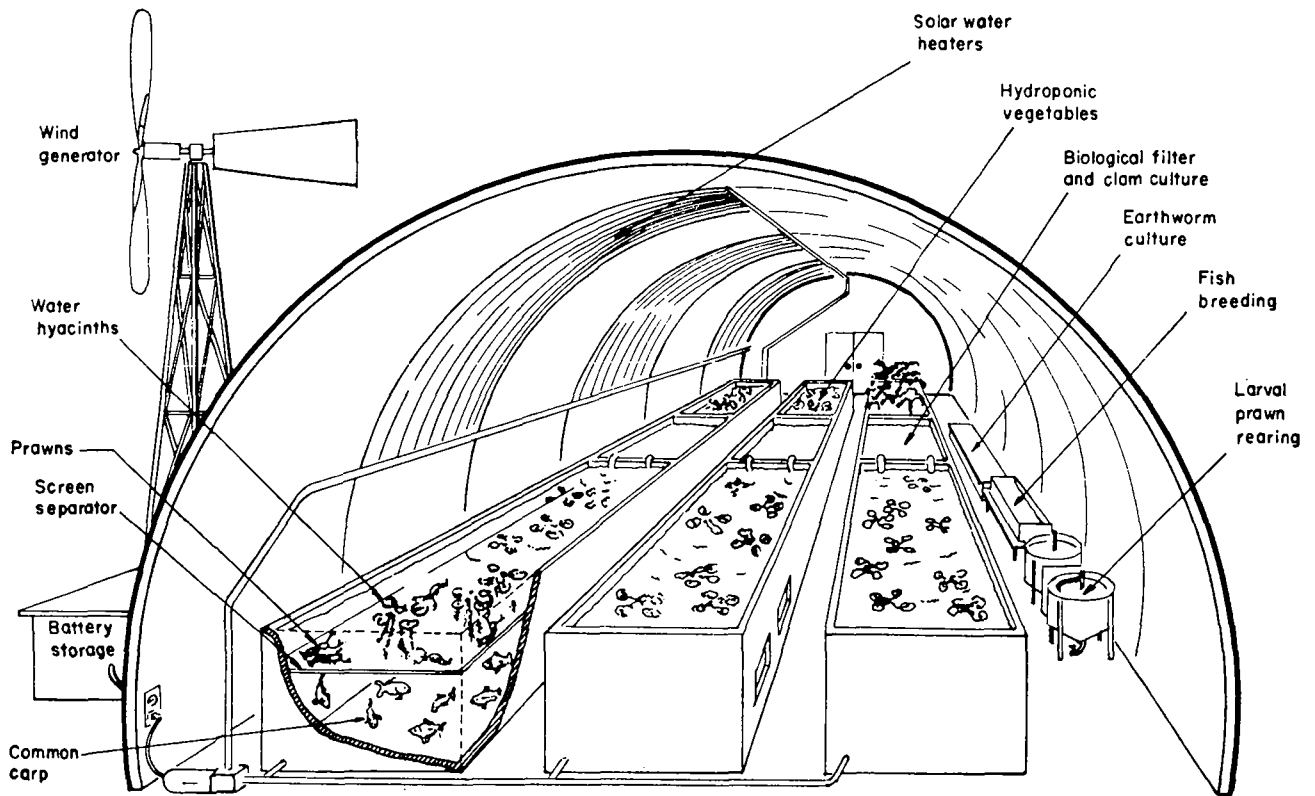

Figure 4. A 30-m x 9-m "Aquasolarium" solar/wind-powered aquatic food production unit

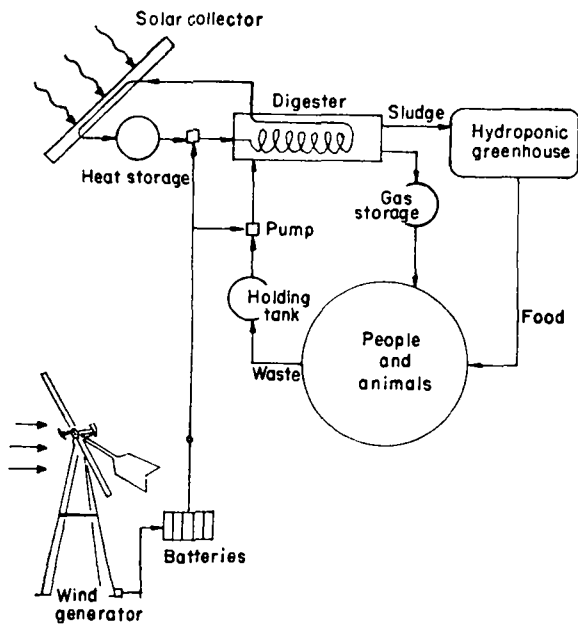

Figure 5. Maximum potential building systems

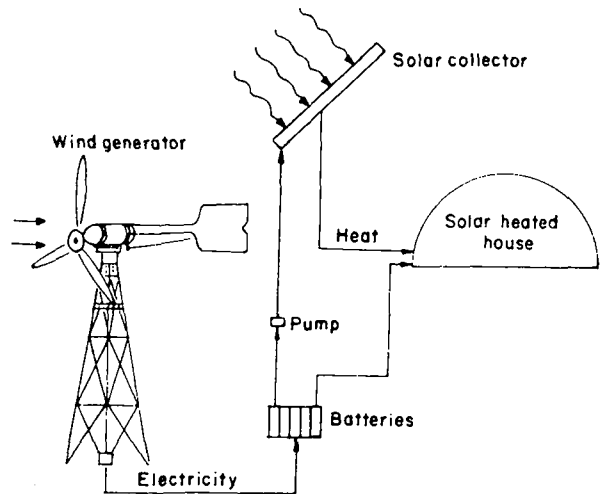

Figure 6. Integrated living systems

**II. INFORMATION PAPER PREPARED BY PARTICIPANT**  
**PLANNING FOR SMALL-SCALE USE OF RENEWABLE ENERGY SOURCES IN FIJI**  
**(NR/ERD/EWGSW/CR.20)\***

*by*

Mr. P. Johnston (Fiji)

**Introduction**

The South Pacific islands generally have limited conventional energy resources. Practically all electricity production is by diesel sets, and all the oil is imported. Petroleum prospecting is under way in several island groups but there have been no commercial finds. Oil will be the predominant energy source for electricity production for some time, although there are medium- to long-term alternatives. Wind energy and solar energy should have considerable potential for the small isolated communities.

Water pumping, lighting, and communications energy needs are met in a few island locations by wind systems. Two Australian Dunlite 2 kW aero-generators were recently installed on Pitcairn Island, several are planned for village lighting in Fiji, and other territories (Tahiti, Cook Islands) have used similar equipment.

In Fiji, solar energy is used for copra drying, salt production, timber drying, and solar water-heating. Water heating has become a thriving industry; 400 locally-assembled units have been installed since 1974 and an additional 50 exported to other islands. There are probably 4,000 solar water-heaters, predominantly of Australian manufacture, in the South Pacific islands.

**I. ENERGY AND DEVELOPMENT PLANNING IN FIJI**

There was little serious concern with energy policy in Fiji until the energy crisis of 1973/74. A committee established in May 1974 reported to the Cabinet in mid-1975 on energy policies and technologies likely to reduce petroleum imports and conserve foreign exchange, and this led to the formation of an Energy Unit within the Central Planning Office.

Even allowing for a greatly expanded programme for rural electrification, approximately 40 per cent of rural areas could not be supplied with transmitted electricity, and it is considered that renewable unconventional energy sources may be viable. The Energy Unit has been allocated \$F 350,000 (\$US 400,000) over the 1976-1980 development plan period to investigate, evaluate and develop possible alternative energy sources. Two specific objectives are:

(a) To assist communities and individuals, particularly in the rural areas, to exploit the sun, wind, water, and wastes as energy sources;

(b) To encourage research into small-scale energy conversion equipment, such as windmills and solar water-heaters, in order to develop cheaper and simpler designs which can be made and maintained locally.

**II. HYPOTHETICAL SOLAR/WIND/BIO-GAS/HYDRO ENERGY CENTRE**

A hypothetical solar/wind/bio-gas/hydro rural energy centre has been postulated, in a community too small for a diesel generator to be viable, too isolated for connexion to an electricity grid, in an area with reasonably good winds and solar radiation, and accessible enough for monitoring.

The assumptions include: a community of 90 people in 15 family dwellings, a mean wind speed of 19 km/h, and mean insolation of 450 cal/cm<sup>2</sup>/day (typically, about 30 per cent more useful wind energy occurs in June/July than in December/January, while insolation values in December/January will be about 60 per cent higher than in June/July), a stream with a useful flow of 2.27 m<sup>3</sup>/min and head of 3 m and the wastes of 60 pigs and 5 kg/day of dry vegetable waste (equivalent to 16 kg of fresh vegetation) available for fuel gas production.

The expected availability of energy would be:

Wind — 2,660 kWh/year electrical, or  
4,380 kWh/year mechanical;

Solar — 970 kWh/year/m<sup>2</sup> low-grade heat;

Hydro — 4,380 kWh/year electrical;

Bio-gas — 12,000 kWh/year high-grade heat.

The extent to which any of the sources would be harnessed, and in what combinations, would depend upon numerous factors, including initial cost, import content, reliability, maintenance costs, and likely disruption of village social patterns, and only a crude comparison can be made of the energy potentially available and the energy needs of the community.

\* Abridged.

**A. LIGHTING FOR FOUR HOURS DAILY**

Because fluorescent tubes are not generally available in Fiji, assume the use of incandescent bulbs. Two lights/house x 15 houses x 60 watts/light would require 2,628 kWh/year, i.e. nearly all the useful output of the wind generator, or 60 per cent of the output of the water turbine. If a wind unit is installed, recall that output in winter (June/July) is 15 per cent above average, while that in summer (Dec/Jan) is about 15 per cent less than average. This means typically 4½ hours/day of light in winter and 3½ hours/day in summer; availability of energy is consistent with demand.

Alternatively, two bio-gas mantles would require about 13,500 kWh/year, rather more than the expected output.

**B. COOKING FOR TWO HOURS DAILY**

For efficiency, cleanliness and ease of use, bio-gas would be ideal, but requirements would be well beyond expected output.

Solar cookers are a possible alternative at midday, but the sun is intermittent and social acceptability is likely to be low. Electric cooking would require 2 kWh/day/family, which is approximately 2.5 times the water turbine output.

If wood were burned directly for cooking, the village would require about 140 kg of wood daily. If wood gas generators could be used, about 70 kg of wood would be needed.

Assuming a village wood gas generator and a bio-gas digester feeding the same reticulation system, fuel gas needs could be met by a combination of wood, faeces, and vegetation waste. In Fiji, there are a great many coconut trees beyond economic bearing age, and these could be a good fuel source. Younger trees are also of use, as one ton of mature coconuts (750-1,000 nuts) yields 450 kg of husk and 160 kg of shell.

**C. WATER PUMPING**

Generally, water pumping is not necessary in Fiji. However, assume the village must be supplied from a source 9 m deep. A requirement of 45 litres/person/day plus extra water for the digester would need approximately 78 kWh/year, which would be no problem electrically or mechanically.

**D. FOOD REFRIGERATION**

A communal unit of 10 cubic feet capacity, run on bio-gas, would take less than half of the bio-gas output, or an electric unit would need about 800

kWh/year. An alternative would be ice block production by using mechanical power to drive a freezer compressor, or solar radiation to run an absorption unit.

**E. SUMMARY OF REQUIREMENTS**

Assuming lighting and water pumping were supplied by electricity, either solar energy or bio-gas could be used for food cooling, and some bio-gas could be used for cooking, supplemented by wood as required. On the basis that needs do not greatly outstrip potential supply, a more rigorous technical-social-economic analysis is seen to be worth-while.

**III. APPROACH TO PRACTICAL RURAL ENERGY CENTRE**

In line with exploratory investigations by the Ministry of Finance and the Central Planning Office of the Government of Fiji, a detailed memorandum was prepared to assist in the selection of a suitable village as a test site.

The memorandum sets out requirements in line with those suggested for the hypothetical energy centre, and gives information on the possible use of renewable energy resources, including some availability data and standard methods of calculating probable energy outputs, and some typical costs.

**IV. AVAILABLE DATA ON WIND AND SOLAR INSOLATION IN FIJI****A. WIND**

Annual meteorological summaries from 1947 to 1970 are available for two stations on the main island of Viti Levu, at Nadi airport and Laucala Bay respectively. The results have been analysed in terms of annual and monthly average wind speed, and variation of wind during the day (at Nadi airport the ratio between wind speed in the afternoon and during the night may be 3:1).

Anemometer records for about 10 years are available for two locations on smaller islands, indicating fairly constant mean wind speeds of the order of 18 km/h, and this result may be typical for many areas in the Pacific.

Some other records have been taken at various locations from time to time, but the reliability of the figures is considered to be somewhat doubtful.

## B. SOLAR INSOLATION

There is very little information on solar insolation in Fiji, with the exception of Nadi airport on the dry side of Viti Levu, where Eppley pyronometers and Brown recorders have been in operation since 1957. There are about ten years of solarimeter data for the sugarmill at Lautoka and limited amounts for two stations in the wet zone: Koronivia Research Station near

Suva and the University of the South Pacific, Laucala Bay, Suva. Mean daily sunshine hours during the period up to 1970 were: Suva, 5.2 hours; Sigatoka, 5.2 hours; Labasa, 5.9 hours, Nadi, 6.9 hours; and Lautoka, 6.9 hours. For Lautoka, the mean insolation from 1959 to 1969 exceeded 570 cal/cm<sup>2</sup>/day. For Nadi, from 1957 to 1973, the mean was about 440 cal/cm<sup>2</sup>/day. However, insolation, as calculated from bright sunshine hours, is about 12 per cent higher at 490 cal/cm<sup>2</sup>/day.

### III. CONSOLIDATED LIST OF REFERENCES ON INTEGRATED SYSTEMS

- T 1. E. W. Golding, "The combination of local sources of energy for isolated communities", *Solar Energy Journal*, II (1), 1958.
- T 2. M. I. Felizardo, "A new tri-energy electric power system for small Philippine communities", *Mechanical Electrical Engineering (Philippines)*, second quarter, 1974.
- T 3. J. E. Bardach, J. H. Ryther and W. O. Mclarney, "Aquaculture: the farming and husbandry of fresh water and marine organisms", Wiley Interscience, 1972.
- T 4. R. Ho, "Mixed farming and multiple cropping in Malaya", *Proceedings of the Symposium on Land Use and Mineral Deposits in Hong Kong, Southern China and Southeast Asia*, S. G. Davis (ed.), Hong Kong University Press, 1961.
- T 5. J. A. Eusebio, "Chlorella — Manure and gas-fish pond recycling system in integrated farming", University of the Philippines, Los Banos College, Philippines, 1975.
- T 6. *Energy Primer*, (USA, Portola Institute, 1975), p. 181.



## ENERGY RESOURCES DEVELOPMENT SERIES

1. RURAL ELECTRIFICATION. United Nations publication, Sales No. 54.II.F.I. Price \$US 0.80 or equivalent in other currencies. Available in English.
2. PROCEEDINGS OF THE REGIONAL SEMINAR ON ENERGY RESOURCES AND ELECTRIC POWER DEVELOPMENT. United Nations publication, Sales No. 62.II.F.8. Price \$US 5.00 or equivalent in other currencies. Available in English.
3. RURAL ELECTRIFICATION IN ASIA AND THE FAR EAST. United Nations publication No. ST/TAO/SER.C/63. Available in English.
4. PUBLIC ELECTRICITY SUPPLY—A MANUAL ON MANAGEMENT. United Nations publication, Sales No. 66.II.F.3. Price \$US 2.00 or equivalent in other currencies. Available in English.
5. THE ROLE AND APPLICATION OF ELECTRIC POWER IN THE INDUSTRIALIZATION OF ASIA AND THE FAR EAST. United Nations publication, Sales No. 66.II.F.4. Price \$US 1.50 or equivalent in other currencies. Available in English.
6. COMPREHENSIVE ENERGY SURVEYS—AN OUTLINE OF PROCEDURE. United Nations publication, Sales No. 67.II.F.14. Price \$US 1.00 or equivalent in other currencies. Available in English.
7. PUBLIC ELECTRICITY SUPPLY—A MANUAL ON UNIFORM SYSTEM OF ACCOUNTING. United Nations publication, Sales No. 67.II.F.16. Price \$US 2.00 or equivalent in other currencies. Available in English.
8. THERMAL POWER STATIONS—A TECHNO-ECONOMIC STUDY. United Nations publication, Sales No. E.70.II.F.2. Price \$US 1.50 or equivalent in other currencies. Available in English.
9. REPORT OF THE SEMINAR-CUM-STUDY TOUR ON LOAD DESPATCH TECHNIQUES AND APPLICATION OF COMPUTER TECHNOLOGY TO POWER SYSTEM ENGINEERING PROBLEMS. United Nations publication, Sales No. E.71.II.F.14. Price \$US 4.00 or equivalent in other currencies. Available in English.
10. BOILER CODES IN THE ECAFE REGION: SUGGESTED GUIDELINES FOR THE OPERATION, CARE AND INSPECTION OF BOILERS. United Nations publication, Sales No. E.72.II.F.21. Price \$US 1.50 or equivalent in other currencies. Available in English.
11. PROCEEDINGS OF THE TWELFTH SESSION OF THE SUB-COMMITTEE ON ENERGY RESOURCES AND ELECTRIC POWER. United Nations publication, Sales No. E.74.II.F.14. Price \$US 12.00 or equivalent in other currencies. Available in English.
12. URBAN ELECTRIFICATION—PLANNING. United Nations publication, Sales No. E.75.II.F.6. Price \$US 6.00 or equivalent in other currencies. Available in English.
13. PROCEEDINGS OF THE INTERGOVERNMENTAL MEETING ON THE IMPACT OF THE CURRENT ENERGY CRISIS ON THE ECONOMY OF THE ESCAP REGION. United Nations publication, Sales No. E.75.II.F.7. Price \$US 10.00 or equivalent in other currencies. Available in English.
14. NATIONAL POWER GRIDS AND EXTRA-HIGH-VOLTAGE SYSTEMS IN THE ESCAP REGION. United Nations publication, Sales No. E.75.II.F.13. Price \$US 4.00 or equivalent in other currencies. Available in English.
15. PROCEEDINGS OF THE SECOND SESSION OF THE COMMITTEE ON NATURAL RESOURCES. United Nations publication, Sales No. E.76.II.F.11. Price \$US 8.00 or equivalent in other currencies. Available in English.

Note: Publications Nos. 1-10 were issued without an Energy Resources Development Series number.

---

### كيفية الحصول على منشورات الأمم المتحدة

يمكن الحصول على منشورات الأمم المتحدة من المكتبات ودور التوزيع في جميع أنحاء العالم. استعلم منها من المكتبة التي تتعامل معها أو اكتب إلى: الأمم المتحدة، قسم البيع في نيويورك أو في جنيف.

#### 如何购取联合国出版物

联合国出版物在全世界各地的书店和经售处均有发售。请向书店询问或写信到纽约或日内瓦的联合国销售组。

#### HOW TO OBTAIN UNITED NATIONS PUBLICATIONS

United Nations publications may be obtained from bookstores and distributors throughout the world. Consult your bookstore or write to: United Nations, Sales Section, New York or Geneva.

#### COMMENT SE PROCURER LES PUBLICATIONS DES NATIONS UNIES

Les publications des Nations Unies sont en vente dans les librairies et les agences dépositaires du monde entier. Informez-vous auprès de votre libraire ou adressez-vous à : Nations Unies, Section des ventes, New York ou Genève.

#### КАК ПОЛУЧИТЬ ИЗДАНИЯ ОРГАНИЗАЦИИ ОБЪЕДИНЕННЫХ НАЦИЙ

Издания Организации Объединенных Наций можно купить в книжных магазинах и агентствах во всех районах мира. Наводите справки об изданиях в вашем книжном магазине или пишите по адресу: Организация Объединенных Наций, Секция по продаже изданий, Нью-Йорк или Женева.

#### COMO CONSEGUIR PUBLICACIONES DE LAS NACIONES UNIDAS

Las publicaciones de las Naciones Unidas están en venta en librerías y casas distribuidoras en todas partes del mundo. Consulte a su librero o diríjase a: Naciones Unidas, Sección de Ventas, Nueva York o Ginebra.

---