

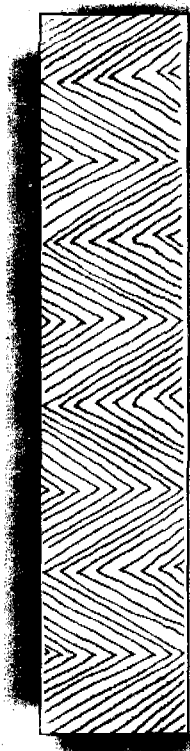

Taking Care of Your Water Supply

A manual for community-based operation and maintenance of piped water systems



IRC INTERNATIONAL WATER AND SANITATION CENTRE

IRC is an independent, non-profit organization. It is supported by and linked with the Netherlands Government, UNDP, UNICEF, the World Bank and WHO. For the latter it acts as a Collaborating Centre for Community Water Supply and Sanitation.

The centre facilitates the availability and use of appropriate knowledge and information in the water, sanitation and related environment sectors in developing countries.

Activities include capacity development for information management, exchange of available knowledge and information, and development and transfer of new knowledge on priority issues. All activities take place in partnership with organizations in developing countries, United Nations organizations, bilateral donors, development banks, and non-governmental organizations.

Emphasis in programme activities is on community-based approaches including rural and low-income urban water supply and sanitation systems, community participation and hygiene education, gender issues, sustainable systems, rehabilitation and environmental management.

The multi-disciplinary staff provides the support through development and demonstration projects, training and education, publications, documentation services, general information dissemination as well as through advisory services and evaluation.

For further information:

IRC
P.O. Box 93190
2509 AD The Hague
The Netherlands

Telephone: +31 - (0)70-33 141 33
Telefax: +31 - (0)70-38 140 34
Telex: 33296 irc nl
Cable: Worldwater, The Hague

Taking Care of Your Water Supply

**A manual for community-based operation and
maintenance of piped water systems**

**IRC International Water and Sanitation Centre
The Hague, The Netherlands**

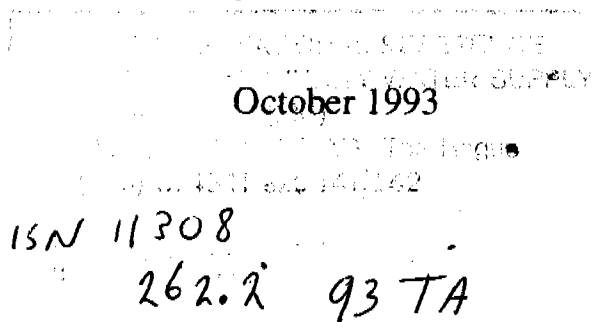

Copyright © IRC International Water and Sanitation Centre 1993

IRC enjoys copyright under Protocol 2 of the Universal Copyright Convention. Nevertheless, permission is hereby granted for reproduction of this material, in whole or part, for educational, scientific, or development related purposes except those involving commercial sale, provided that (a) full citation of the source is given and (b) notification is given in writing to IRC, P.O. Box 93190, 2509 AD The Hague, The Netherlands.

CONTENTS

	Page
PREFACE	v
1 INTRODUCTION	1
1.1 An operation and maintenance problem	2
1.2 The partnership concept	4
1.3 The benefits	5
2 PIPED WATER SUPPLIES FOR SMALL COMMUNITIES	7
2.1 Piped water supply scheme	8
2.2 Components of piped water supply	9
2.3 Service-levels	16
2.4 Standposts	18
3 THE PARTNERSHIP APPROACH	21
3.1 Introduction	22
3.2 Operation and maintenance responsibilities	24
3.3 Community organization	26
3.4 Water agency support	33
3.5 The private sector	40
3.6 Financing operation and maintenance	43
4 COMMUNITY RESPONSIBILITIES AND TASKS	47
4.1 Water handling practices	48
4.2 User operation of a standpost supply	50
4.3 Preventive maintenance	53
4.4 Minor repairs	62
4.5 Major problems	69
GLOSSARY	71
APPENDICES	75

PREFACE

A main constraint in the long term sustainability of piped water supplies in developing countries is the lack of adequate provision for operation and maintenance. The involvement of users in the operation and maintenance of their own supply is becoming accepted as feasible and necessary to overcome this problem. The approach entails a partnership between community, government departments and external support agencies in which there is a clear understanding and agreement between the partners of their different roles and responsibilities.

The Netherlands Directorate-General for International Co-operation (DGIS) supported IRC in the development of approaches to community-based public standpost supplies in four developing countries: Malawi, Zambia, Indonesia and Sri Lanka. The Public Standpost Water Supplies demonstration project (1983-1986) encouraged community involvement in all stages of project development, including operation and maintenance. A follow-up project in Malawi and Zambia, Piped Supplies for Small Communities (1988-1992), developed and applied the approach further. This manual draws on the experience of the two projects.

The manual provides guidelines on the essential issues to consider for the effective involvement of users in operation and maintenance activities. It is intended as an aid to personnel at district and similar level, who are responsible for piped supplies for small communities. Each of the 4 chapters starts with a short introduction and a summary of the key message and its effects. At the end, a glossary of words and terms used is provided.

Michael Seager of IRC initiated the development of this publication. Contributions to this manual have been provided by Sue Laver, Lizette Burgers, Peter Heeres, Jo Smet and Jan Davis. The illustrations were made by Kors de Waard and Chung-Hsi Han. The draft was reviewed by Mary Boesveld, François Brikké and Han Heijnen. The lay out was done by Chung-Hsi Han while the desktopping of the final draft was done by Lauren Wolvers.

IRC wants to thank all contributors. This document is developed in the framework of the Piped Supplies for Small Communities (PSSC) project which is financially supported by the Netherlands Directorate General for International Cooperation (DGIS).

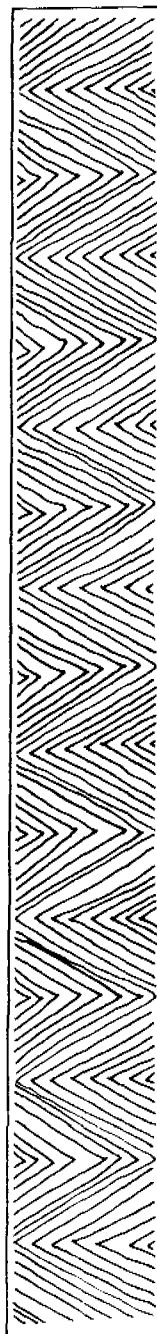

1 INTRODUCTION

There is no point in constructing a new piped water supply if it cannot be properly operated and maintained. This may seem obvious, yet many piped water supplies have been constructed in the past with little or no attention to the needs of long term operation and maintenance. The result has been the breakdown of many piped supply systems. This should be avoided in future.

External support agencies can fund the construction of new supplies but they cannot provide long-term support to run them. Water agencies are often unable to provide the service required to keep supplies in good working order due to a lack of money and resources. A way to overcome these problems is to involve the community, as a partner to the water agency, to share the responsibility for operation and maintenance.

The IRC-supported Piped Supplies for Small Communities (PSSC) Project has built on the experience of earlier projects to develop a community-based approach to piped water supplies. The results indicate that active community involvement can be effective, and is necessary, if supplies are to continue working long after the end of construction. This manual considers the issues involved and provides guidelines for the involvement of users in the operation and maintenance of their own piped supplies. The manual is primarily meant for district water department staff involved in community-based water supply systems.

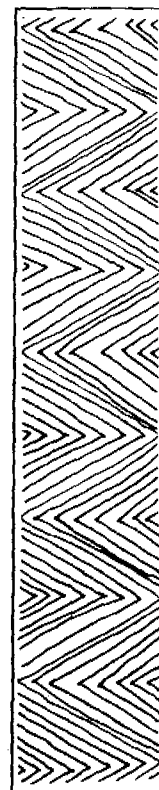

COMMUNITY-BASED APPROACH

- Early involvement of community in planning of new supplies.
- Sharing responsibility for quality and maintenance.

EFFECTS

- Supplies continue to function a long time.
 - Improved water use.
 - More convenience and time-saving.
 - Health and financial benefits.
-

1.1 An operation and maintenance problem

A community standpost which has not been properly looked after will be taken as an example to illustrate the problems which can arise from poor and inadequate operation and maintenance.

Technical problems:

- The tap is broken and in need of repair.
- One tap has been stolen.
- The standpost is cracked and in danger of breaking up.
- The drainage channel is blocked.
- The soakaway needs repair and stones have been taken away.
- The meter box lock is broken and the cover has been moved.
- No effort has been made to keep the surroundings clean.

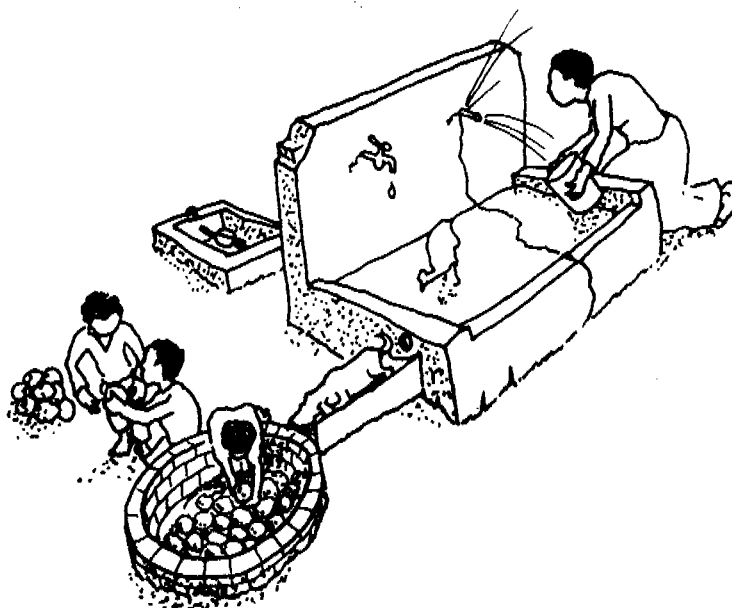

Managerial problems:

- Nobody has taken responsibility for the standpost.
- There is a lack of motivation to look after the standpost.
- The users lack basic skills for maintenance and repairs.
- The children are undisciplined and play around the supply.
- Animals are allowed around the standpost.

Community problems:

- No one looking after the supply.
- No cement for repair.
- No tools or spare parts for repair.
- No report that the meter box lock was broken.
- No key for the meter box.
- Parents allow their children to vandalise the supply.
- No arrangement for the users to contact the water agency.
- No monthly water contribution for the cost of repairs.
- Bad taste of water, so no collection from tap.
- Bad sited standpost so no looking after by villagers.

Who is to blame?

The water agency probably does not have enough staff to look after all the standposts in their district and, anyway, they do not have adequate transport, fuel and spares to do the job properly. Perhaps the water agency staff assumed the community would look after the standpost. Even if the users did want to repair the standpost, they probably did not have the skills or receive the training required for such a job.

Users and water agency staff often do not see the same problem in the same way.

No one in particular is to blame, so:

Community-based operation and maintenance aims for a closer collaboration between users and the water agency to overcome these misunderstandings and difficulties.



1.2 The partnership concept

- **Sharing responsibility**

The concept of community-based operation and maintenance implies that the users of a supply take a far greater share of the responsibility for operation and maintenance than has been usual in the past. The limitation on how much responsibility users can take depends on the organizational, financial and technical capabilities of the communities.

- **Technology level suiting local skills**

The water supply technology and form of organization required must suit the existing locally available skills, or skills which could be acquired by community members. Therefore, community education and training in operation and maintenance tasks and responsibilities should be a part of the overall development of piped water supply projects.

- **Additional Training**

The need for additional technical and managerial skills training should be realistically assessed after exploring the range of operation and maintenance problems which



commonly occur in a piped water supply system. This process should be a collaboration between the community and the water agency. It should not be imposed on a community from outside.

- **Increasing responsibility for community**

At the beginning of a partnership a community may only be responsible for minor tasks but could develop skills and confidence to take on more responsibility in the future. The water agency will need to provide continuous support in several areas including: major repairs, training, and monitoring of the continuing functioning and use of systems. This continuing support, through water agency maintenance and extension staff, will be crucial to the success of the partnership.

- **Involving private sector**

Another potential partner is the private sector. There are several opportunities for private individuals and small businesses to be involved in activities that the water agency may have carried out in the past. These include: operating equipment; servicing and repairs; revenue collection; and as suppliers of equipment and spare parts to both the community and the water agency.

1.3 The benefits

Why should users be involved in operation and maintenance activities? A look at the benefits to both the community and water agency will make this clear.

Community benefits:

- **Reduced breakdowns**
Users can reduce the number of interruptions of a supply by carrying out preventive maintenance.
- **Reduced breakdown time**
Users can respond quickly to minor breakdowns when they do occur leading to a more reliable supply.
- **Time saving**
Major problems can be reported quickly and the community can assist the water agency to speed up major repairs.
- **Reduced water charges**
Community members will recognise the cost of water resulting from their involvement in maintenance work. They may therefore be more ready to save water, look after the system, and be prepared to pay for a reliable supply. In turn, a reliable supply is cheaper to run and so charges to the users should be less.
Proper operation and maintenance by the community eases the task, and therefore reduces the operational costs, of the water agency. This, again, should reduce charges to the users.
- **Improved health**
During breakdown of their safe water supply, users would collect water from their old water sources but a more reliable piped water supply will avoid the need to use these unhealthy sources.
- **Women's Involvement**
User participation may create the opportunity for women to be involved in decision making and management activities.
- **Less dependency**
Communities will be less dependent on outside assistance for the repair of their supply and they will develop local skills and resources which can be used in other community development activities.
- **Better security**
Responsibility for their own supply will help to develop a sense of community ownership which may reduce theft of equipment and vandalism of the supply facilities.

Water agency benefits:

- ***Reduced pressure on agency staff***
Less time required by water agency staff to attend to minor repairs allowing them to provide a better major repair service.
- ***Better revenue collection***
A reliable water supply will encourage users to pay for their supply and therefore give the agency the funds to carry out their responsibilities.

The overall benefit to everyone is more reliable and sustainable piped water supplies.

2 PIPED WATER SUPPLIES FOR SMALL COMMUNITIES

To have an idea what the partnership concept is in practice, one must have some knowledge of the technical aspects of piped water supply. If one is aware of the functioning of each component and its inter-relation, one can easily analyze what kind of operation and maintenance is required daily, weekly or in case of damage or in case no water arrives at standpost.

In this chapter, the piped water supply scheme, its principal components and alternatives are described without going too much into detail.

Special attention is paid to elements the community is directly involved in i.e. service level and standposts. Several possibilities of service levels as well as for construction of standposts are described. Ways and timing to involve the community in these possibilities are discussed.

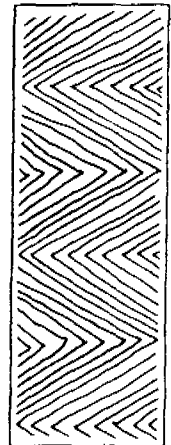

UPGRADE KNOWLEDGE OF PIPED WATER SUPPLY

- Inform community of water supply scheme and its components.
- Inform community where they can be involved.

EFFECTS

- Functioning of water supply system is understood.
 - Construction becomes part of community.
 - Damage can be prevented or reported or repaired by community.
-

2.1 Piped water supply scheme

Before considering the components, a general pumped piped water supply scheme is described. In this scheme the interrelation between the components is illustrated. The water is transported through pumping from the intake to the treatment (if required) and then to the water storage tower. From there the water is distributed via the distribution system to the supply points.

One scheme might supply a village, numerous neighbourhoods or several villages, depending on their size and the distance between them.

The scheme shown is just an example. Treatment can be avoided when the water source is groundwater or a spring instead of surface water. The pumping station can be avoided when the level of the source is high above the village level so water flows by gravity force. In such a case, a break pressure tank will be required to reduce pressure in pipes (see scheme appendix A.1).

Major components

1. Water source
2. Intake
3. Treatment (if required)
4. Pumping station
5. Water storage tower or tank
6. Distribution system with mains, service pipes and standposts

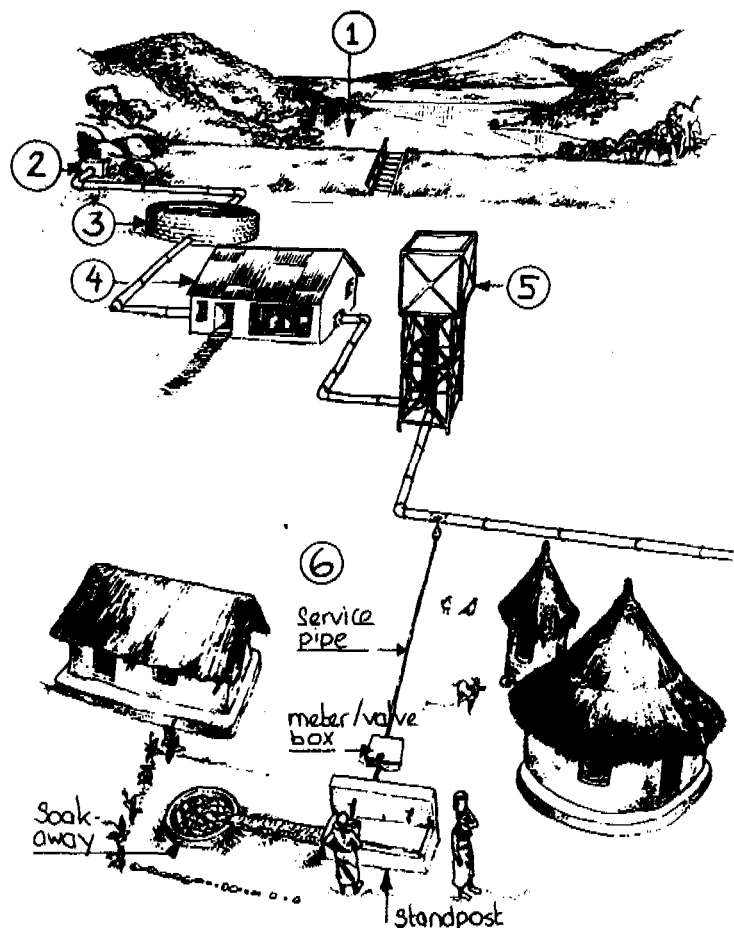

Note: pipe routes are shown but all pipes should be buried and covered.

2.2 Components of a piped water supply scheme

Taken the drawing of piped water supply as starting point, the components are described as the water flows: from source to treatment, from pump station to storage tank and from storage to distribution system.

Water source

Two potential sources can be distinguished. The main difference between them is the water quality, which is described below.

- **Surface water**

Surface water is a common source for piped supplies. It may be a stream, river or lake. Water treatment is necessary if the water is polluted. Pollution can be caused by people washing in the river or using the river as a site for defecation. Surface waters are also open to pollution by animals and from agriculture and industry. Contact with and drinking of polluted water can be dangerous for the health of consumers. In certain climates, high silt loads may be experienced during periods of heavy rainfall due to soil particles washed into water courses and lakes.

Too much silt causes:

- Excessive wear and tear of valves, meters, taps.
- Hinder of flow in pipes.
- Deterioration in water quality.

- **Groundwater**

Groundwater is generally of a higher quality than surface water. Normally, groundwater requires only the minimum of treatment, if any at all, unless there are particular problems. Groundwater may be obtained from wells or springs. A protected spring can be a very good source since the water will flow by gravity, it will require little maintenance and can provide water of a high quality. Groundwater from wells will require a pump to raise the water.

Intake

If an intake can be positioned at a height suitable for supply by gravity, a carefully designed system can be simple to operate and maintain. The figure below shows one form of surface water intake which includes: screens to protect the intake; a silt chamber; and a valve chamber. It is important to remove as much sand and silt in the water before it enters the distribution pipes for reasons mentioned under the heading surface water (page 9).

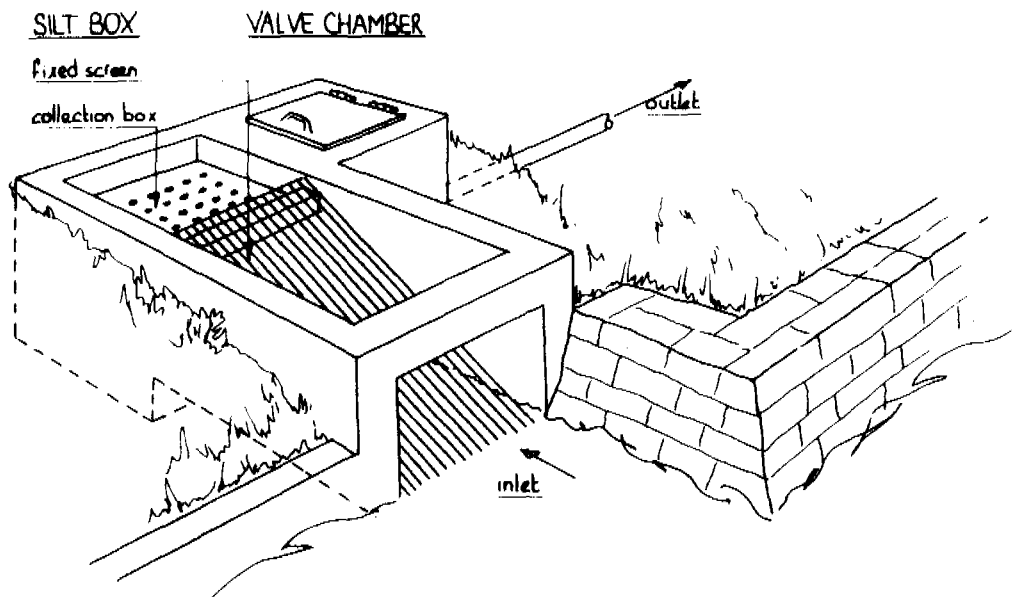

Water treatment

If the water is too polluted thus giving health risks if drunk, or if the water contains a lot of silt, then water needs to be treated before it can be distributed.

However, water treatment should be avoided whenever possible because:

- It makes the water supply system more complex.
- It is costly to build.
- The operation and maintenance of a treatment plant will require considerable inputs and finance to keep the system running.

To reduce pollution, one can apply slow sand filtration with or without chlorination. To reduce excess silt load, one can apply a pretreatment. Some water treatment options are described in appendix A.2.

Pumping station

For operation and maintenance, the pumping station requires skilled labour for daily care, oil and petrol.

Storage tanks

In the course of a day, the quantity of water taken from the taps, called the water demand, varies. Busy periods typically occur early in the morning and at the end of the afternoon. When villagers get up, they will take a bath and need water for preparing food. In the afternoon, this will be repeated. These periods with a more than average use of water are called peakhours.

Why storage tanks?

- **Balancing out the peak demand**

For a variety of reasons, the quantity of water supplied by a source may not be sufficient to satisfy the peak demand periods. Stream and spring flows can vary greatly from one season to another. During the rains a source may be more than adequate to supply all the water required, even at peak times. However, during the dry season this may not be possible.

For pumped supplies, it would be uneconomic to install pumps large enough to supply the amount of water required only at peak times because for the rest of the day, such a high flow rate would not be needed and the pump would be oversized for the job.

In these cases, a storage tank is included in the system to balance out the peak demand for water. A storage tank (sometimes called a service or balancing reservoir) is filled during the periods when few people are collecting water. The stored water will then be available to add to the source supply at peak times.

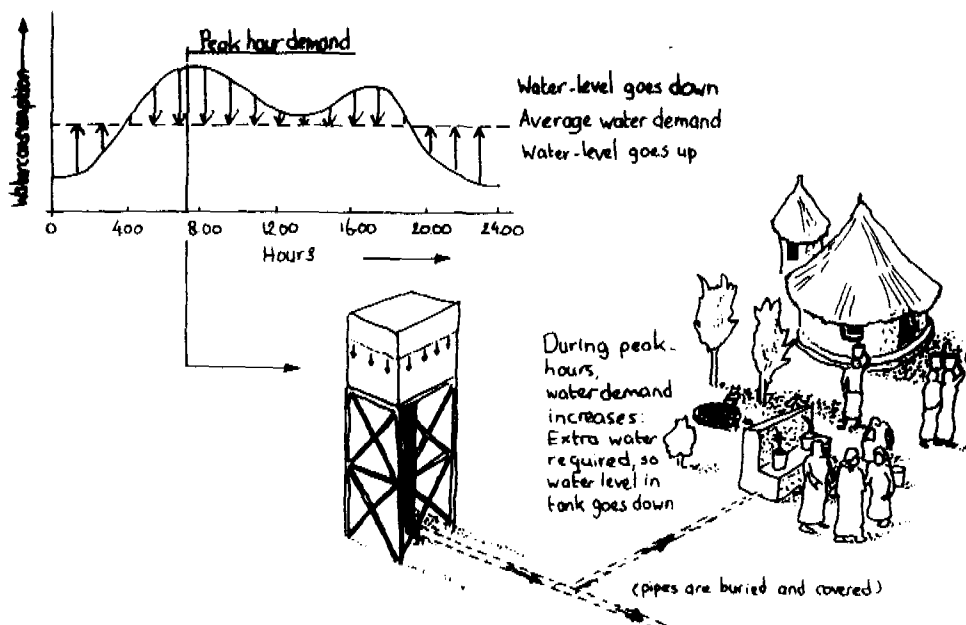

- **Safety measure**

The storage tank also acts as a safety measure. A reserve of water will help maintain a supply if there is a breakdown, or shutdown, at the source. It is important for operators to be aware of the need to keep storage tanks 'topped-up' for both balancing the demand and as a reserve of water.

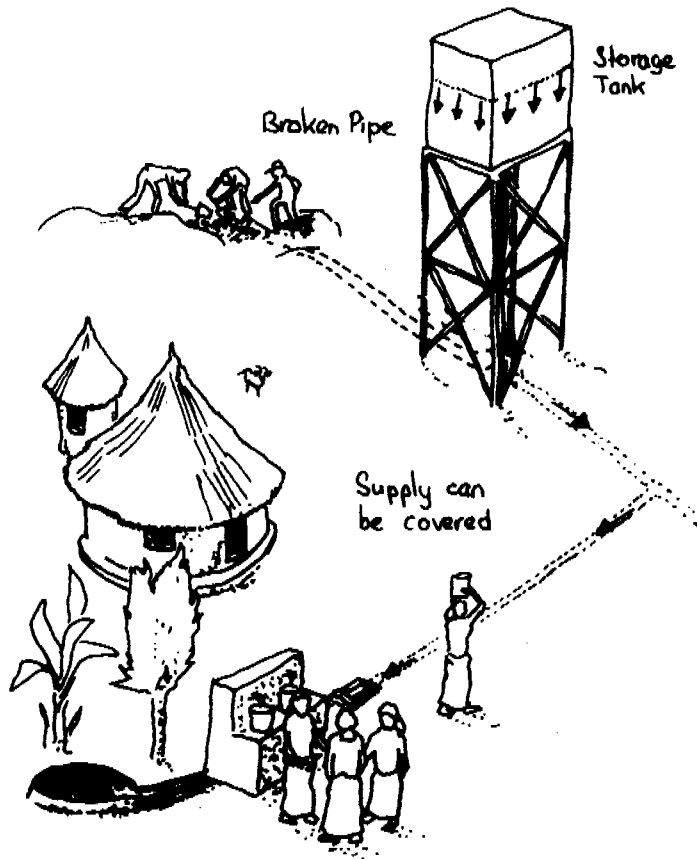

- **Even out pressure variations**

In larger distribution systems, branch pipelines might be subject to large variations in pressure. In order to even out these pressure variations, a tank can be placed at the head of the branch after the junction with the main. The tank will serve two purposes: it will maintain a more even pressure on the branch; and it will serve as an extra reserve of water in case of breakdown further up the system.

How to situate storage tank

Storage tanks should be situated at a height which maintains sufficient pressure in the distribution system for a good flow of water at the taps. This means that in flat areas the storage tank will need to be elevated.

Water distribution

The water distribution system conveys the water from the source, or reservoir, to the point of collection for use. The distribution system includes pipeline, valves, water meters and break-pressure tanks.

Pipelines

There can be several types of pipes in a piped supply scheme.

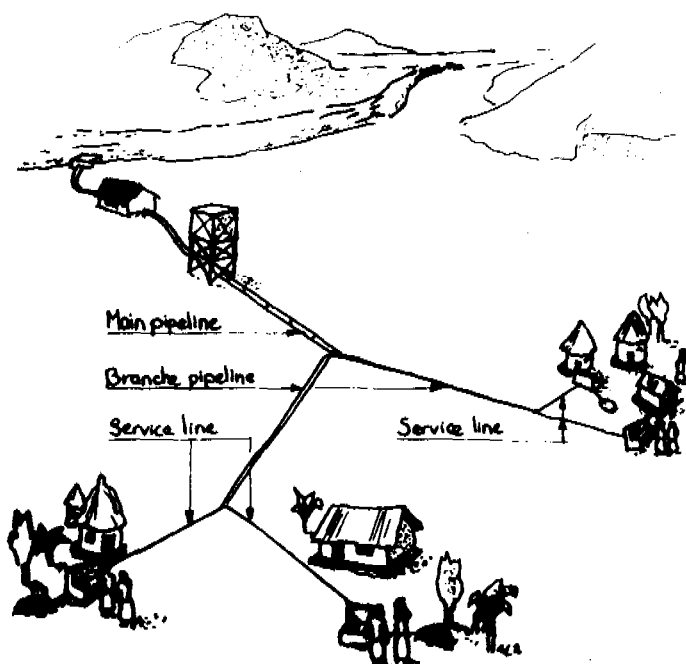

- **Main pipeline, or 'main'**
This line carries the water from the source, or storage reservoir, to the user community.
- **Branch pipeline**
carries water from the main to a village, or section of a village. Depending on the system design, in a basic system there may be no branch pipelines but just one main pipeline to a community. Alternatively, there may be two, or more, main branches in which each branch main serves different areas.
- **Service pipe**
Smaller service pipes lead from the branch mains to either individual taps in private homes, yard taps or standposts.

In addition to the pipes in the distribution system, there may also be a pipe from the source to the storage reservoir. In the case of a pumped scheme, the pipe delivering water from the source to the reservoir is called a rising main.

Valves

Several valves are required to control a piped supply.

- **Gate valves**

Gate valves are used to isolate the supply at the following points:

- On the outlet of the storage reservoir to control flow into the system.
- At the start of each branch pipeline to isolate a branch for maintenance and repairs.

There will be additional gate valves for draining tanks, draining the pipeline and, in a system involving pumps, associated with the pumping plant.

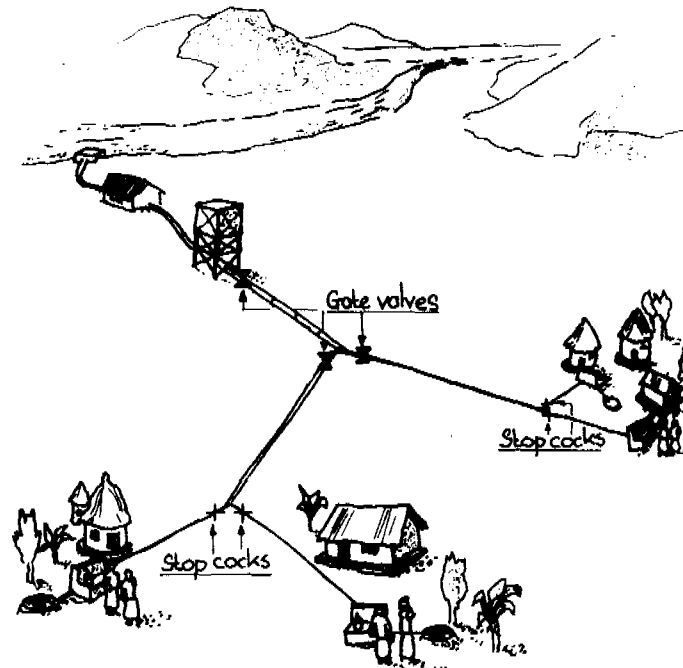

- **Stop-cock**

A 'stop-cock' is used to isolate each service pipe for maintenance and repairs. It also provides operational flexibility if the amount of water available is to be shared among users. Stop-cocks are often left out because of costs and need for extra operation and maintenance care.

Water meters

A water meter is sometimes fitted in the service pipe so that the flow of water to an individual connection or community standpost can be measured and charged for, usually on a regular basis, e.g. monthly.

Break-pressure tanks

A break-pressure tank reduces the pressure in a piped system to atmospheric pressure. That is, it prevents a build up of high pressure by 'releasing' it from the pipe into a tank where the water surface is in contact with the open air. Without break-pressure tanks the pressure in a pipe may be so great as to burst the pipe or fittings attached to it.

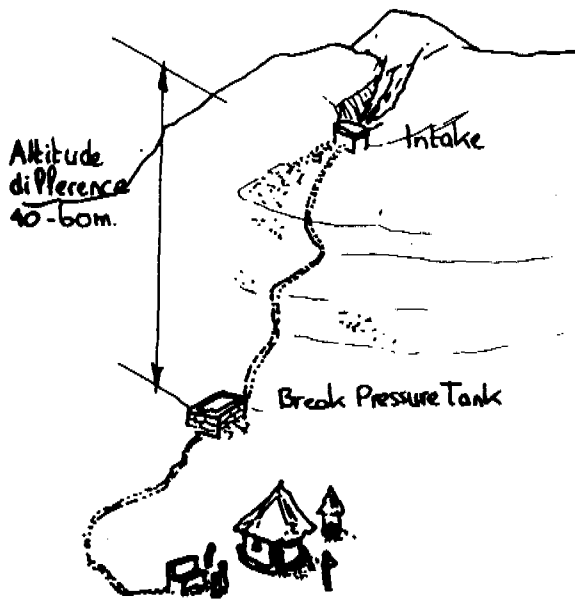

If a valve is closed suddenly against fast flowing water, very high pressures can be created, called 'water-hammer', which can lead to burst pipes. Break-pressure tanks, on a steep downhill pipeline for example, allow for slower flows of water which reduces the severity of 'water-hammer'.

Break-pressure tanks, therefore, play an important role in a piped water supply and should be well maintained. They should never be by-passed by connecting the inlet and outlet pipes. There are various designs of break-pressure tanks, some of which are not 'tanks' but pipework arrangements. A tank design is shown below.

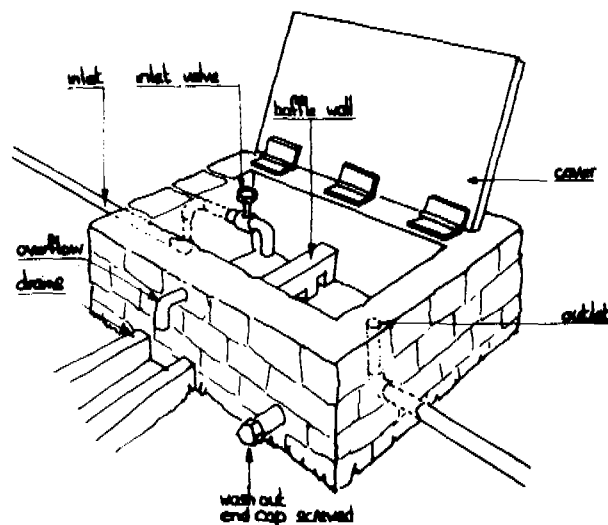

2.3 Service-levels

Pipes can supply water at various service-levels. As a service-level increases, the supply becomes more convenient to the user. The highest service-level is to have safe water piped directly to taps in a house. It is also the most costly. There is a trade-off between having the most reliable, convenient and safe supply, at a cost that people can afford.

Different service levels

The different service-levels can be listed as follows:

- ***House connections***
Usually several taps in a house; normally found in high income areas.
- ***Yard connections***
A tap or standpost is located in a courtyard or compound, serving one or a number of families.
- ***Standposts***
Neighbourhood or multi-family taps (standposts with one or more taps), shared by up to 50-200 persons from a block of houses or a number of household compounds.
- ***Public standposts***
where use is not restricted in any way to a particular group or community.

Quantity of water

The quantity of water used by people will vary according to the convenience of the supply. The table on the next page shows the domestic water usage for different piped supply systems. It is clear that with higher service-levels the water consumption increases. The consequent benefits would also be expected to increase.

Supply type	Typical consumption (litres per person per day)	Range
Standpost/well about 1 km away	7	5 - 10
Standpost/well about 500m away	12	10 - 15
Village standpost/well up to 250m away	20	15 - 25
Neighbourhood standpost up to 250m away	30	20 - 50
Yard connection	40	20 - 80
House connection - single tap	50	30 - 60
House connection - several taps	150	70 - 240

from: IRC, (1991). Partners for Progress (Sustainable Piped Water Supplies) TP 28

Ownership and responsibility

Ownership and responsibility are key differences between yard or house connections, and standposts.

- ***Yard and house connections***

Yard and house connections are the responsibility of one household: the landlord, the owner or tenants of the house or compound. They are responsible for the operation and maintenance of the connection.

- ***Standposts***

Standposts, however, are used by a large number of families and so the responsibility for care and correct use is shared by many people. In the context of community based maintenance, therefore, it is important to consider standposts in more detail.

2.4 Standposts

A standpost is usually a solid structure of concrete, plastered burnt bricks or blocks with one, two, or more taps. Components are:

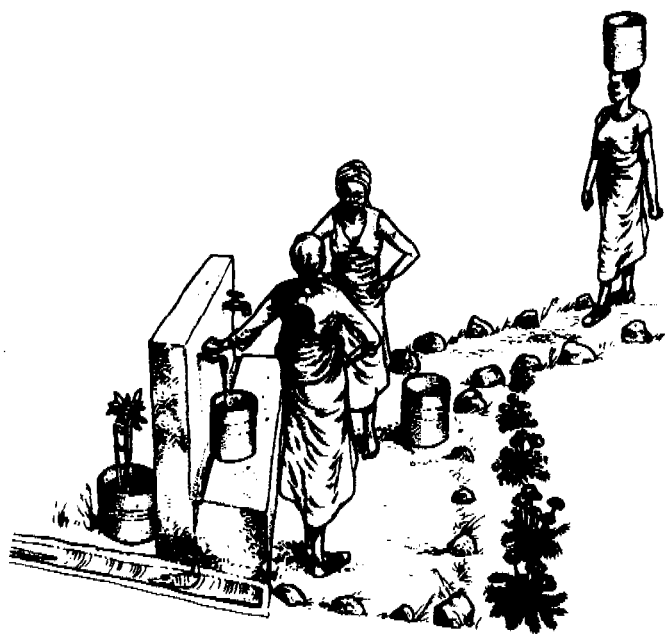

- **Container rest**
A concrete stand should be provided on which containers can rest while drawing water from a tap.
- **Floor slab**
The floor slab, preferably made of concrete, is constructed around the standpost. It should be big enough to catch the water which is splashed during the filling and cleaning of containers and direct the spilt water to the drain.
- **Service pipe**
Standpost supplies are connected by service pipes to the mains.
- **Water meter**
A meter is often attached to the service pipe so that the flow of water to the users can be measured.
- **Valve**
If agreed by the users, the supply can be turned on and off by a valve, fitted to the service pipe, to control opening and closing times.
- **Valve/meter box**
The valve and meter, which are usually next to each other, are usually set inside a small chamber constructed of blocks, or bricks. This valve/meter box has a cover which can be locked for security.
- **Drainage**
Drainage of spilt water from the floor slab is by a run-off channel to a soakaway. Good drainage prevents the development of a dirty, muddy area around the standpost. Apart from being dangerously slippery, a wet, dirty floor slab is ideal for hookworm, roundworm (ascaris) development, and mosquito breeding.

- **Soakaway**

A soakaway is a pit of a certain diameter and depth filled with rubbles to drain the spilt water into the soil.

- **Trees, grass and plants**

It is common for users to plant grass and plants (e.g. banana trees) to use up the drainage water so that it becomes a more attractive and healthy place. Water could also be drained to a small fenced vegetable garden.

- **Fencing**

A fencing of thorn shrubs prevents domestic animals, such as goats, pigs etc., from freely walking around and polluting the standpost area. A drinking water supply must be treated with care to prevent contamination and so the standpost and immediate surroundings should be kept clean.



- **Standpost designs**

Standpost designs vary from one scheme to another. They can often be improved to reduce construction costs and make them more convenient for people to use and look after. Users, particularly children should be involved in the design of the standpost so that they can contribute their ideas to the height of the bucket stand, the number of taps, where the water should drain (a soakaway or vegetable garden), and so on. If many children will be using the standpost, this should be taken into account. Perhaps a special low tap can be built for children.



Important

It is important to consult all members of the community on standpost design because they may have different uses for the water.



- ***Farmers***

Farmers with animals may want to water their animals:

- Should they be allowed to water animals at the standpost?
- Should animal drinking troughs be included?

- ***Women***

Women, who normally carry out the domestic duties, may want to use the water for clothes washing:

- Should they be allowed to wash clothes at the standpost?
- Should special areas for washing be identified and washing slabs built?

SO:

Consultation on the design of standposts and a need for additional feature as troughs washing slabs, bathing places is part of the partnership approach.

3 THE PARTNERSHIP APPROACH

The actual practise of the partnership approach requires insight in the responsibilities of operation and maintenance. It must be clear and outspoken what the tasks are and how the tasks are divided amongst the community, water agency and private sector. When those tasks are clear, it has to be filled within an organizational frame. This frame will guard that tasks are taken care of.

This chapter considers steps involved in applying the partnership approach to the operation and maintenance of piped water supplies. Special attention is payed to:

- Division of responsibilities between the partners.
- Organizational set up and possible tasks within the community.
- The possible ways of support to the community by the water agency.
- The extent the private sector can be involved and its consequences.
- Financing of operation and maintenance.

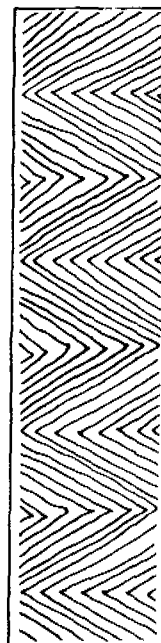

THE PARTNERSHIP APPROACH

- Knowledge of tasks, responsibilities and organizational frame of partners involved.

EFFECTS

- Steady organization built up around water supply.
 - Benefits of the cooperation between partners.
 - Empowerment of community with benefits for other projects.
-

3.1 Introduction

Advantages of partnership approach at start of a project

The consideration of community-based operation and maintenance at the earliest possible stage in the planning of a project can have several advantages:



- **Community Is Involved In decisions**
The community can be involved in deciding how far they would be willing and able to participate in operation and maintenance.
- **Technology level suiting local skills**
Technology can be chosen to suit the existing or potential skills available within a community.
- **Responsibilities fit with community organizations**
Suitable community organizations to take on these responsibilities can be identified or established at an early stage.
- **Sharing responsibilities = avoiding misunderstandings**
The water agency and community can generally agree on their different roles and responsibilities before construction to establish a good partnership at the beginning of a project and so avoid misunderstandings in the future.

Partnership at existing projects

In existing projects, there may have been no previous opportunity to consider operation and maintenance by the community. The starting point may therefore be with a project which was not designed for community involvement.

In this case it is then important for the partners to sit together and carefully consider the implications of community-based operation and maintenance.

Questions to be considered for both partners:

- Can the community afford the total cost of operation and maintenance and, if not, what can they afford?
- What technical changes may be required, and possible, for the supply system, such as more valves, to allow for community control?
- What will be the division of responsibilities between the partners?
- What support, including training, can the water agency give to the community?
- Should there be a trial period for the new arrangement?
- How can the scheme be monitored?

3.2 Operation and maintenance responsibilities

Before deciding the operation and maintenance responsibilities of each partner, it is first important to clarify what is meant by the terms 'operation' and 'maintenance'.

- **Major operations**
This includes all the major operations of the entire scheme required to get safe drinking water into the distribution system.
- **Operation of water collection points**
This includes the responsibility for opening and closing service pipes; and the correct use of standposts, including drainage of spilled water.
- **Hygienic handling and use of water**
Obtaining safe water from a piped supply is only one stage to improving the health of a community. The correct handling of water to keep it safe is just as important.
- **Maintenance**
Often used loosely, to mean the repair of broken equipment. In this manual the word is used in a broader sense. Maintenance should be seen, not only as repair work, but as a way of preventing the breakdown of equipment in the first place. This is referred to as preventive maintenance.
- **Preventive maintenance**
Means the prevention of breakdowns through good operation procedures, routine inspection and checking, and timely servicing of equipment and facilities. Preventive maintenance includes simple activities such as replacing a washer in a dripping tap, or cleaning out the soakaway pit. These activities can be carried out by the users themselves, provided they are given the basic training and equipment to do the job.
- **Corrective maintenance**
The routine minor repair of equipment and facilities.
- **Emergency maintenance**
Major repair work when the system as a whole is affected.

Correct operation practices and preventive maintenance reduce the need for both corrective and emergency maintenance.

Responsibility

The responsibility for operation and maintenance tasks can be divided between the community, water agency, and the private sector according to each partner's abilities and willingness to participate.

Particular tasks could be contracted out to the private sector by either the water agency or community. A community may not have the skills for the tasks required but could be in the position of contracting private individuals for maintenance work.

Table: Tasks that partners may undertake as a first stage in community-based operation and maintenance

	<i>Community</i>	<i>Water Agency</i>	<i>Private Sector</i>
Operation:			
Pumps	-	operate	operate
Intake	control	control	control
Treatment	-	operate	operate
Distribution	control	control	
Standpost	control	read meter, education, monitor	read meter
Water use	control	education, monitor	-
Maintenance:			
Catchment	protect	monitor	-
Pumps	-	service, repair	service, repair
Intake	clean	clean, repair	clean, repair
Spring	clean	inspect, repair	repair
Treatment	clean	monitor, repair	monitor, repair
Tanks	clean	inspect, repair	inspect, repair
Main pipes	dig trenches, assist in repair	inspect, repair	repair
Service pipes	repair	monitor	*repair
Standposts	monitor, repair	monitor meter repair	*repair meter repair

* the community may contract a plumber or mason for repair work.

The table above indicates the tasks that partners may undertake as a starting point for the development of community based operation and maintenance. Water agency tasks will move over to the community if the system becomes more community managed. The private sector will continue to play its role.

3.3 Community organization

This section considers how the community can:

- Organize community operation and maintenance.
- Collect money for running a piped supply.

These two points are linked together: good operation and maintenance requires proper organization which is also an important pre-condition for regular payment by the users. When the water supply is not working well, the users will not want to pay.

This can be the start of a vicious circle: poor payment leads to a lack of funds for maintenance and repairs. If this happens, the system will become less reliable. Users will be reluctant to pay for an unreliable supply. It will then become more difficult to collect the money to pay for maintenance, and so the problem gets ever worse.

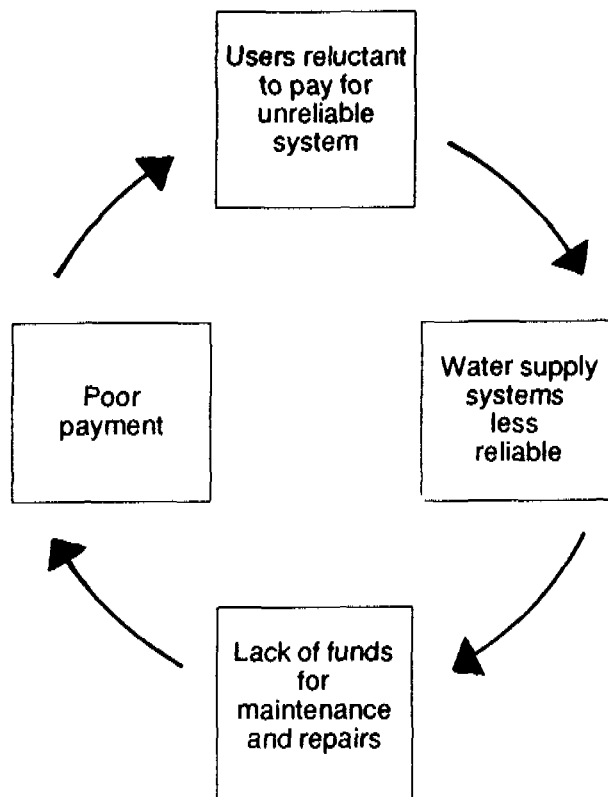

Organization

The form of user organization will depend on a number of factors including:

- Existing community organizations.
- Traditional forms of representation.
- The size of the scheme.

If there is no existing community organization through which operation and maintenance could be managed, then a water committee structure might be appropriate.

An example of a committee structure is the following:

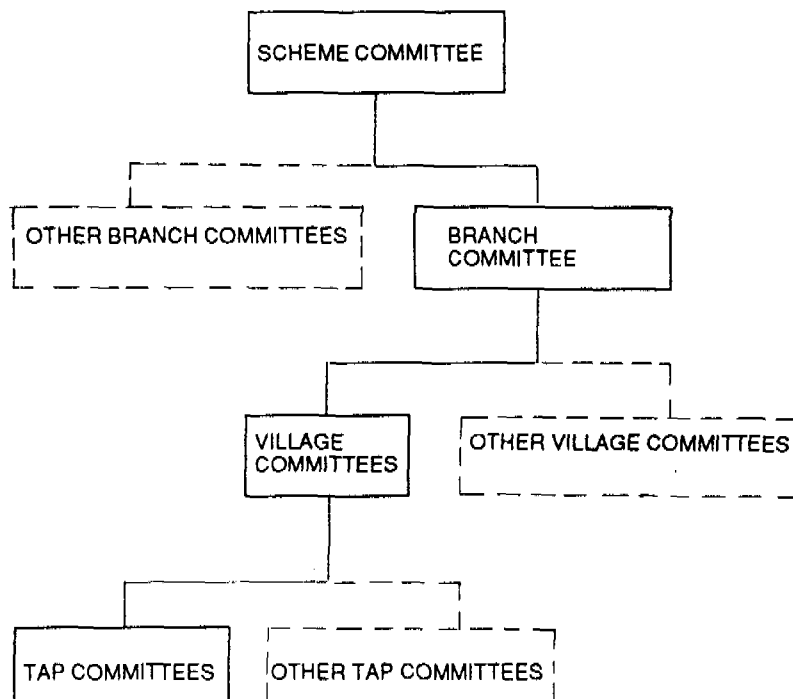

The diagram serves to show how all the different levels and types of committees might relate to each other. In practice, several variations are possible. In some schemes for example, the Tap Committees report directly to the Scheme Committee and there are no branch or village committees.

The different types of water committees each have their functions according to the size and type of scheme but they cannot be effective without people to do the physical work of looking after the system - the caretakers. The following description of committees starts at the neighbourhood level, the Tap Committees, and also considers the position of caretakers at this level.

Water committees at neighbourhood level

Tap committee members

Live near the standpost for which they are responsible. Members are often the women who use the taps.

Typical tap committee tasks are:

- Registration of users.
- Deciding opening and closing times.
- Daily opening and closing of the supply valve.
- Keeping the meter/valve box key.
- Regular collection of water rates.
- Maintaining financial records.
- Paying water bills to the water agency.
- Organizing self-help maintenance.
- Keeping the standpost and surroundings in good condition.
- Repair and replacement of taps.
- Care and repair of the service pipe.
- Reporting major breakdowns.



The caretaker

Is usually someone from the community who is also a member of the Tap Committee. When there is a problem, the first person to contact is the caretaker. A caretaker's responsibilities include regular daily and weekly checks, preventive maintenance tasks, and minor repairs to taps, etc. Notes may be kept by the caretaker on the condition of the system and the work done, including records of the parts replaced. The caretaker, a man or a woman, plays a key role in a community-based water supply system.

Water committees at village and scheme level

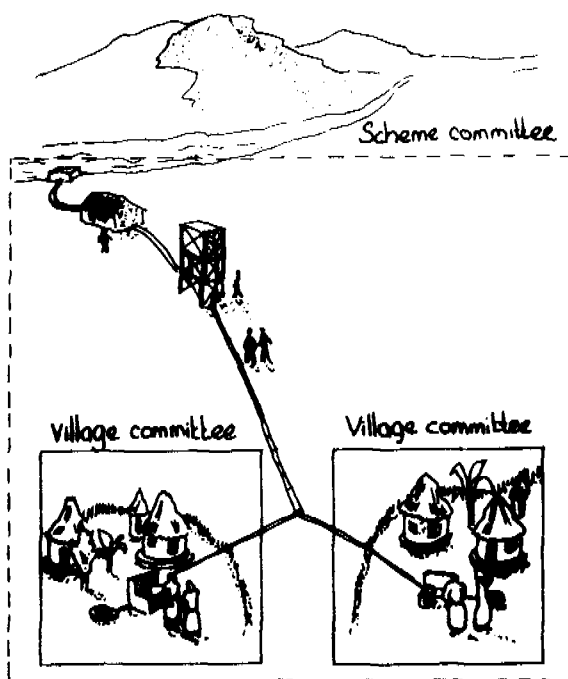

- **Village water committees**

Village water committees are formed to manage a complete supply, not just a part of it, as in the case of Tap Committees. They discuss with the Tap Committees and caretakers the running of the system, operation and maintenance, repairs required, financial contributions, and future developments. The Village Water Committee normally includes representatives of all groups and key people within a community such as teachers, health workers and so on. The inclusion of women in the committee is particularly important as it is the women who are usually responsible for the collection and use of water.

- **A scheme committee**

A scheme committee is advisable where piped supplies serve more than one village. Committee members are representatives of the communities served. The Scheme Committee has the main task of managing the water supply scheme to satisfy the needs of each community. The main issues the committee considers are: the allocation of water between villages; the overall operation and maintenance of the system; extensions and modifications; the collection of water charges; and fund raising.

- **Branch committees**

Large schemes, with several main branches, may also have Branch Committees. They represent all consumers on a single branch of the distribution system.

Committee membership

Should community caretakers be volunteers or paid? Every situation is different, and caretaker compensation, in cash or in kind, will vary according to the local situation. The form and amount of compensation will depend on a number of factors:

- The amount of work involved.
- The skills required for the job.
- The country's labour laws.
- The opportunity for sharing the work.
- The advantages to the caretaker of doing the work, e.g. release from other duties, use of the tools for other work, the proceeds of standpost gardens, etc.

Scheme and village water committee members are usually volunteers. They may be elected, or appointed by community leaders, the local government or the water agency. Membership numbers will vary but usually comprise a chairperson, secretary, treasurer, and ordinary committee members. It is important for committee members to be respected and trusted if they are to represent the community fairly and effectively.

Experience indicates that some committees can become dominated by strong characters and leaders with the result that ordinary committee members lose interest and fail to participate. The value of having a representative committee is then lost. Training of committee members through water agency support is very important to try to avoid such problems.

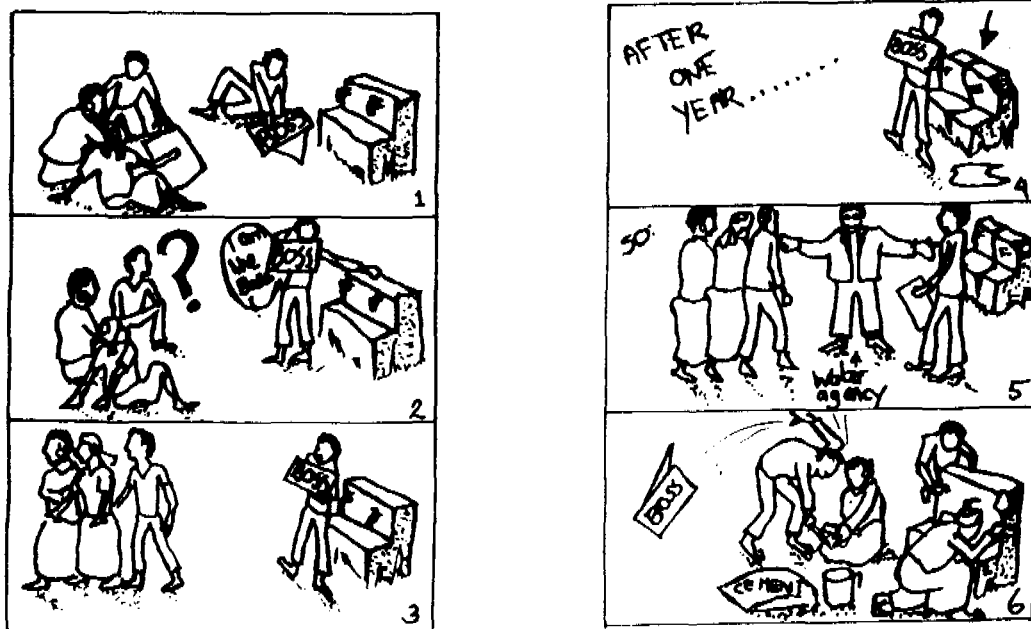

Formal agreement

A formal agreement sets out a water committee's responsibilities. An agreement may simply be between the community and water agency. Alternatively, it could be a legal document which gives a committee legal recognition.

Agreements establish the roles and responsibilities of the partners, committee members and officers. An agreement document can be referred to in any future misunderstandings or problems related to the activities of a committee or committee officer.

Typical roles and responsibilities of a scheme or village water committee might include:

- The solution of disputes.
- Keeping an effective reporting system.
- Selection of users for training.
- Maintaining contacts with the water extension staff.
- Collection of money, raising funds and responsibility for spare parts, materials and equipment for maintenance.
- Assistance of water agency staff with major repairs.

Some examples of forms of agreement between committees and the water agency:

- The water agency operates the scheme as a whole, and the committee takes responsibility for the upkeep of the standposts and service pipes.
- The water agency supplies water to each main branch line from where branch committees take over responsibility for the operation and maintenance of each branch.
- The committee may supervise agency-paid operators who operate and maintain a system.

Water societies

Water Societies are a development of the water committee concept in which a water supply scheme is run as a business. The water committee acts as the executive management committee of a society. The following case illustrates how a society works.

A Water Society was formed by the amalgamation of five small self-help groups. They were assisted to establish a business oriented approach to their water project through the employment of a manager and technical staff to run the water supply scheme. The volunteer management committee consists of 8 members who are elected each year by the members of the Society. Membership is open to community members who pay an entrance fee.

Members continue contributions until they contribute enough for a yard connection. The connection is metered and billing is monthly. In a period of 7 years membership has reached over 2,000. The water agency has provided support throughout and is available for technical advice through the district office. The supply is now being extended.

In a Water Society, the water supply scheme is owned and managed by the community members who belong to the society. The concept of the water society has many advantages but may only be appropriate in certain circumstances: members need to be familiar with the working of committees; yard connections are easier to manage because the Society only deals with one individual per connection; external support from outside agencies, including the water agency, can be crucial to success.

3.4 Water agency support

The concept of community-based operation and maintenance is aimed at relieving the burden on water agencies who are unable to look after and operate schemes. Many water agencies, therefore, would be very happy to pass on the tasks of operation and maintenance. However, this does not mean that the agency's responsibilities cease completely. The water agency will need to continue appropriate support to communities in partnership with them.

The implication of this approach is a change in role for the water agency. The water agency will no longer be expected to carry out all maintenance activities and respond to minor repairs. However, they should be prepared to give advice and training to community caretakers on maintenance procedures and repair work. Water officers will need to undergo a change in attitude from providers of a service to supporters of local community initiatives.

The changing role of water committees

From

To

Providers
of a
Service

Supporter
of Local
Community
Initiatives

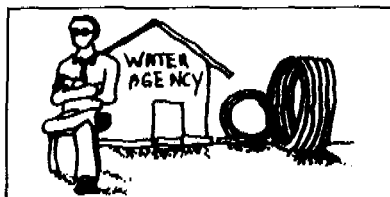

Water agency roles

As described on previous pages, the role of the water agency will change while introducing the concept of community-based operation and maintenance. The following changes can be expected:

- **Transferring activities to community**
Minor operation activities and regular preventive maintenance can be transferred to the community. An agency's technical role of major operation and maintenance activities will continue. The agency will also play a role in the extension or expansion of the scheme when the community grows or expands.
- **Reorganization of own agency**
A water agency may have to re-organize the way it has traditionally worked to cope with this change in responsibilities. For example, fewer repair mechanics will be directly involved in minor repair work but they may be required to train community caretakers to do the work instead.
Water agency staff will need to be given guidance on how the partnership with communities is expected to work and training will be necessary for staff directly involved.
- **Building of staff attitude**
The attitude of staff is important because they may have little interest or incentive to promote community participation. They may even feel threatened that some of their work will be taken away and their jobs may appear at risk.
- **More monitoring**
Regular monitoring of water supplies will be necessary to check that communities are able to run their own supplies. At the same time, the water agency must be willing to listen to the difficulties that communities may have in taking over operation and maintenance duties. Changes and modifications may be needed to make the partnership work.

Support to the community

There is a range of support that a water agency can give to communities and they will each be considered in turn:

- Training and advice
- Community organization and liaison
- Liaison with other departments
- Hygiene education
- Monitoring
- Revenue collection
- Promotion of contacts between user groups
- Develop community capabilities

- ***Training and advice***

At the outset, the water agency will have to give advice to the community on the measures required to operate and maintain their system. The advisory role will include the training of caretakers and community members involved in the running of the scheme. Well planned training will be necessary, with regular follow-up to ensure the training has been successful.

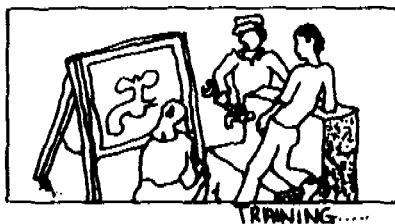

- ***Community organization and liaison***

The extent to which communities are able to organize themselves to manage a system will depend on their existing community organization and experience of taking on such responsibilities. Most communities will require some assistance from water agency extension staff.

A water agency may decide to work together with other government departments or support agencies, such as non-governmental organizations (NGOs), to provide the extension inputs required. It is the water agency who will need to act as the co-ordinator of these inputs.

- **Liaison with other departments**

Various government departments may also be involved in supporting the partnership. Other relevant departments may be called upon to participate such as: Community Services, Social Welfare, Rural Development, etc. Where matters of money are concerned, such as charging for water, the department of Local Government or District Administration could be involved. Water and health are strongly linked and, therefore, the Ministry of Health may also have a part to play.

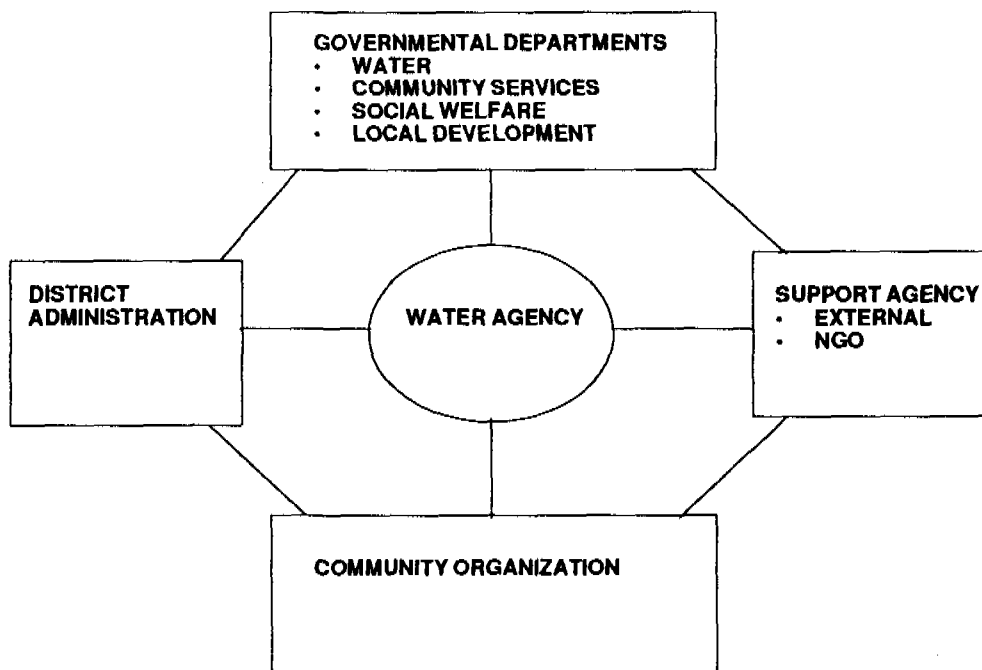

- **Hygiene education**

To maximise the potential benefits of a water supply, users need to be aware of the connections between water and health. In some cases, incorrect operation and poor care of a supply can increase health problems rather than improve a community's health. Poor standpost surroundings, for example, can encourage the transmission of disease.

Hygiene education, on the hygienic care of a supply and use of water, may be carried out by trained water agency staff or staff from the Ministry of Health. It is important to emphasize that hygiene education is a long term undertaking, working with the community over a period of time, on their health problems and ways of solving them.

- **Monitoring**

It is important, especially in the initial stages, for the water agency to monitor the effectiveness of community operation and maintenance. It is in the water agency's interest to keep a check on the functioning of a water supply before any major problems arise which the agency will be required to put right.

Monitoring support visits should not be done in a way which seeks to condemn the community for not doing their job. An inspection visit should be seen as an opportunity to look for solutions to problems and to give on-the-spot advice and training.

MONITORING.....

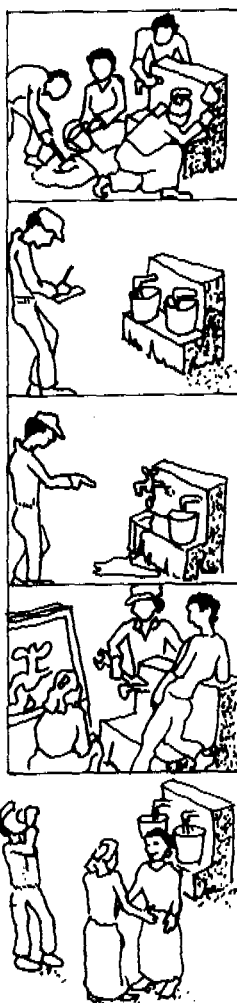

NO MONITORING.....



Monitoring can cover a range of issues.

Technical

The number of standposts out of action; standpost down-time; common breakages; spares demand, etc.

Financial

Keeping accounts, revenue collection, banking arrangements, the costs of the scheme to the community and the water agency, etc.

Organizational

Committee meetings - their effectiveness, frequency, participation of women, etc.; the contacts between water agency and community; the involvement of other agencies, etc.

Monitoring can provide the information to indicate:

- The success of a scheme.
- If there are likely to be problems in the future.
- Ways of improving the scheme.
- Useful lessons for other projects.

Information from individual schemes can be compiled at district and regional levels to give an overview of a programme. Where possible, the use of computer data base programmes make it easier to collect and present the information in a way which can quickly show trends and potential problems.

A water agency will be interested in the progress of community operation and maintenance of communal water points. The following is an extract from a standpost monitoring form.

EXAMPLE

STANDPOST MONITORING FORM					
Village:				
Date of visit:				
Date of previous visit				
Standposts location
Functioning	Y/N	Y/N	Y/N	Y/N	Y/N
Average down-time since last visit					
Defects since last visit	Y/N	Y/N	Y/N	Y/N	Y/N
Total cash contribution last month
Total spent on spares last month
Spares purchased:
Positive financial balance	Y/N	Y/N	Y/N	Y/N	Y/N
Committee meetings	Y/N	Y/N	Y/N	Y/N	Y/N
Problems in water committee	Y/N	Y/N	Y/N	Y/N	Y/N
Problems users group	Y/N	Y/N	Y/N	Y/N	Y/N
Contact water agency	Y/N	Y/N	Y/N	Y/N	Y/N

An example of a form for the collection of data on a complete gravity scheme is given in Appendix 3.

- **Revenue collection**

The collection of money charged for water can be carried out either by the community or directly by the water agency. In both cases the water agency is involved with the community in:

- Choosing the method of charging.
- Estimating the level of charges needed to cover costs.
- Agreeing on a method of collecting the money.
- Training of community members in billing and bookkeeping.
- Checking and auditing the accounts.

Metered supplies require extra administrative tasks, some of which may be undertaken by the community. Community members may be trained by the water agency to read meters or it may remain the responsibility of the water agency.

- **Promotion of contacts between user groups**

Water agencies can promote contact between communities. There are several advantages to this:

- Communities can learn from each other.
- A community wanting to start their own community based management can be encouraged by those who already manage their own supply.
- Several communities can form an association for the purpose of group purchases of tools and equipment, fuel and spare parts, water treatment chemicals, etc.

- **Develop community capabilities**

As populations expand, there will be a need to extend distribution systems. Higher service levels will be demanded as the development of communities progresses. For example, moving from standposts to yard connections. Water agency support can assist the development of skills within communities to either improve and modify the systems themselves or engage private contractors to carry out the work.

3.5 The private sector

Private sector involvement in water supplies is already widespread through the selling of water. Water sellers may be private individuals or small businesses. A water agency may rent a standpost supply (sometimes called a kiosk) to a private individual to sell water at the standpost site. The advantage to the water agency is that the standpost is carefully looked after, water wastage is reduced, and payment is guaranteed.

Apart from water selling, there are many other opportunities for the involvement of the private sector as a partner in the management of water supplies.

What kind of partner?

Public organizations are often criticized for their inefficiency, bureaucracy, and general inability to get on with a job. This may be for many reasons, including a lack of funds and poor staff incentive to give a satisfactory service. People or companies in the private sector, however, have a far greater incentive to complete a job: they need to make a profit.

- ***Possible problems***

The problems associated with the private sector concern the need to make a profit. A job may be done in the cheapest and quickest way, simply to increase profits. The result may be a bad job carried out with poor materials by cheap unskilled labour. A private water seller may be able to charge an unreasonably high rate for water in the absence of alternative supplies.

- ***Condition for partnership***

If the private sector are to be involved in the operation and maintenance of piped water supplies then their activities need to be monitored and regulated to be acceptable. Monitoring and supervision can be carried out by both the water agency and water committees. This kind of partnership between the public and private sector and community aims to benefit from their different strengths and to avoid their weaknesses. (see figure page 37)

There are a variety of individuals, small and large businesses within the private sector who could contribute to the operation and maintenance of water supplies:

- **Individuals**
Mechanics
Plumbers
Blacksmiths
Accountants
Administrators

- **Small businesses**
Building contractors
Plumbing contractors
Suppliers of
technical goods

- **Large contractors**
Civil engineering
Road construction

Private sector roles

Both the water agency and communities, through their water committees, can enter into contracts with the private sector. This can be for a range of work associated with operation and maintenance.

- **Technical work**
Major and Minor repairs
Operation
Revenue
Supplier

- **Operation**
Pumping
Treatment plant
Selling water
The transport of water

- **Revenue collection**
Meter reading
Billing and collection
Debt collection
Auditing accounts

- **Supplies**
Spare parts
Oil and fuel
Equipment
Tools and Materials
Chemicals for treatment

There are cases where water supplies serve both private companies and the public. The following case illustrates this kind of arrangement.

A canal from a river intake transported water over a distance of 10km for the use of a mining company in its mines. The canal carried far more water than the mine needed and so the water agency was able to install pumping and treatment plant to serve several communities at different points along the canal. It was in the interest of the mining company to keep the water flowing in the canal so they ensured the intake and canal were well maintained. The water agency looked after the pumping and treatment plant. Each community took responsibility for its own branch line and standposts.

Similar partnerships are possible in smaller agricultural communities where water is required for growing and crop processing, e.g. tea estates, coffee washing, etc. However, safeguards may also be required to guarantee the public an agreed share of the water. A formal agreement may be advisable to protect the interests of the community dependent on the supply.

Private sector support

A problem that both private sector individuals and companies may have is a lack of specific expertise in the tasks associated with a piped water supply. Further training will then be required. The water agency could provide this training and monitor the work done.

Individuals may have the necessary skills but lack the money to equip themselves with tools and materials. Loan arrangements could be considered for the initial stages of work.

3.6 Financing operation and maintenance

A large part of the money needed to build a piped water supply system is often provided by the government or a donor. Only a minor part is usually contributed by the community. Donors do not provide funds for the long term running of schemes and many governments find it difficult to provide the money required to run a water supply once it has been built.

It therefore becomes the community's responsibility to contribute to the running of their own supply.

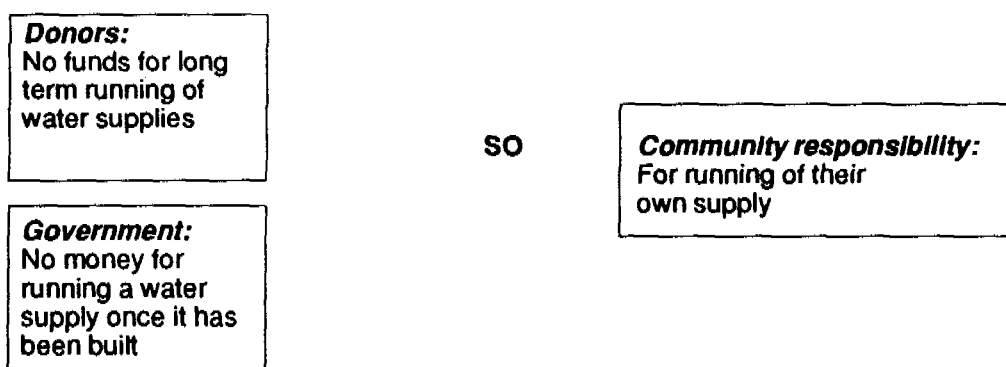

The cost of running a scheme includes:

- **Operation and maintenance**
Including fuel for pumps, chemicals such as chlorine for treatment, spare parts and materials for repairs;
- **Standard charges to the water agency**
Which are used to pay the salaries of staff for operation and major repairs;
- **Water agency inspectors**
Who monitor the running of the system and check water quality.

Important

When planning a piped water supply system explain clearly to the community:

- How the charges are arrived at
- How their money will be spent.

Nobody wants to pay if it is not clear how their money is to be used.

Methods of charging

- ***Community fund raising***

Community fund raising means that people do not pay on a regular basis for their water supply but only when funds are required. This avoids the need to estimate, or measure, the amount of water consumed by each person or household. Charging in this way is then simpler and cheaper than regular charges.

Community fund raising includes:

- Voluntary fund raising through household collections, agreed sums levied by community leaders, festivals, and so on.
- Profits from communally owned activities, such as cultivating a communal farm.
- Community revolving funds for annual maintenance and repairs.

Small gravity piped schemes with communal standposts may only require occasional funds for the operation and maintenance tasks required. In such cases, regular charging for water may not be necessary and the costs of running schemes may be covered by community fund raising.

In agricultural regions where income varies greatly throughout the year, community fund raising will be most effective during harvest time when farmers have sold their crops and have money in their pockets. This is a situation where close consultation between the water agency and community could agree on a method of water payment most favourable to both partners.

- **Regular charges**

Regular charges, however, ensure a stable and predictable income required for the operation and maintenance of many piped water supplies. Table below lists several methods of charging on a regular basis.

Type of charge	Method
Flat rate charge per person	All members of the community have access to a standpost supply and pay a regular (monthly) charge
Flat rate charge per household	All community members have access to a standpost supply and each household head pays a regular (monthly) charge
Charge per unit volume (e.g. per m ³)	Consumers buy water from public standposts (water kiosks) and pay for the volume collected, or for each full container
Agreed user-group charge	Each user-group pays for an agreed quantity of water collected from a standpost (e.g. so many buckets each month), checked against a standpost meter reading
Metered charge	<ul style="list-style-type: none"> i) Flows to standpost and taps are metered and consumers pay according to the volume of water used each month ii) All consumers have a metered supply and pay a fixed charge for up to a maximum amount of water and pay extra for additional water used above the maximum amount

- **Mixed systems**

Mixed systems are another alternative form of charging. For example, public standpost users receive water free of charge and wealthier users with private connections, pay a charge which covers the total cost of operation and maintenance. This is an extreme case of what is known as a cross subsidy in which one group financially supports another.

- **Graded rates**

Graded rates may be possible in areas where there is a big difference in incomes or where water is also used for economic purposes. Wealthy households pay a higher flat rate than poorer households. Water for economic activities may have a different rate. Some examples of such activities are guest houses, cafeteria's, beer brewery, brick making, cattle etc. Community has to decide on the rates.

- **Metered systems**

Metered systems must have someone to read the water meters, someone to make out the bills, and someone to collect the money. Meters need to be checked from time to time to ensure they are working properly and have not been damaged or tampered with. The management of metered charges will generally cost more than unmetered supplies because of the more complicated process of meter reading, billing and collection.

The choice of charging system

The choice of charging system will depend on a number of factors including:

- How frequently funds must be collected i.e. regular or periodic charging.
- The availability of skills to read meters, keep financial records, and send out bills.
- Acceptability, whether a mixed or graded rate system of charging is acceptable to all members of the community.
- The vending of water by private persons.

Method of collection

"Collecting money costs money". The amount of money collected must pay for both the running costs of the supply and the cost of collection itself.

The method of collection should, therefore, be cheap, efficient and acceptable to all consumers. Charges, sometimes called water rates or bills, may be collected by the water agency or the community, depending on the agreement. Community collections include:

- House-to-house collection by a committee member or community paid collector.
- Payment by users to a 'water office' or house of the committee member responsible, e.g. treasurer.
- Collection by each tap committee representative who pays to a central collector.

4 **COMMUNITY RESPONSIBILITIES AND TASKS**

Community involvement requires a clear-cut in responsibility and tasks. Besides that, users must be encouraged in the correct operation and use of their supply as well as the regular checking of components of the piped water scheme. This reduces breakdowns and lengthen the life of the individual components of the water supply system.

This chapter looks at the practical details of community involvement in the operation and maintenance of piped water supplies.

The subjects covered in this chapter are:

- Water handling practices to be discussed with the community to reduce contamination during water collection and water storage.
- The kind of operation the user needs to do at the standpost and whose responsibility this will be.
- Preventive maintenance that need to be looked after to keep the system running.
- Minor and major repairs of the water supply system.

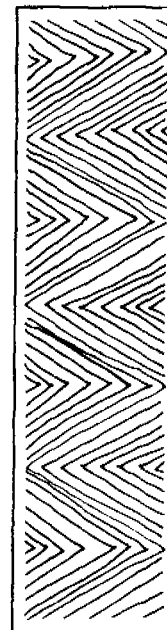

COMMUNITY INVOLVEMENT

- Clear responsibilities and tasks.
- Encouragement in correct operation and use of their supply.

EFFECTS

- Reduction breakdowns.
 - Lengthen the life of individual components of the water supply system.
-

4.1 Water handling practices

Careful handling of water from the standpost tap to the final point of use is necessary if it is to remain of good quality and the full benefits of a piped supply are to be realised. The following notes can be used as guidelines by extension staff in the encouragement of users in good water handling practices.

Excreta-related health problems, such as diarrhoea, can be transmitted through the contamination route:

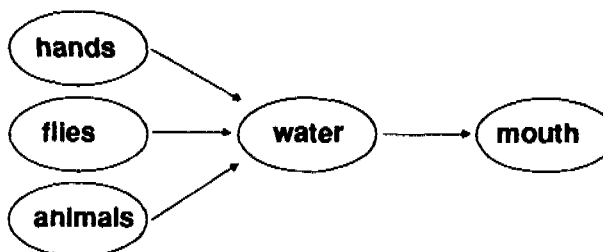

The chances of contamination can be reduced by following simple procedures during water collection and storage.

Water collection

The following points should be observed when collecting water.

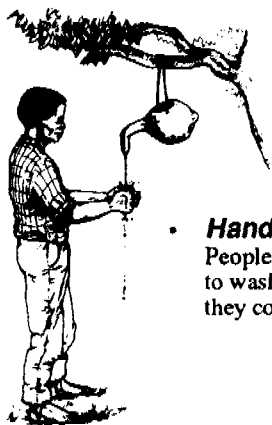

- **Handwashing**
People should be encouraged to wash their hands before they collect water.



- **Cover containers**
Containers should be covered with something clean, like a cloth, to prevent contamination of the water by dust and flies during carrying.

- **Clean containers**
Containers should be washed before collection. The washing of containers should be done in a way which safely disposes of the washing water without leaving wet, muddy, pools of water around the standpost.



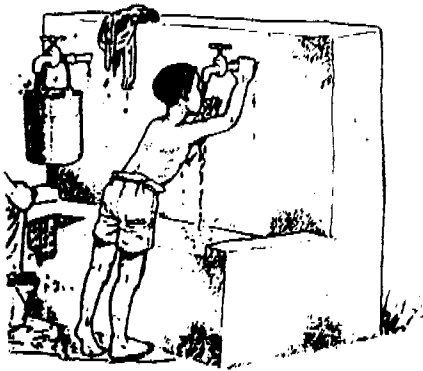

- **No spillage**
Spilt water around the standpost will create unsafe and dangerous conditions for users. All waste water should be directed to the drainage channel.
- **Close taps**
Taps should not be left open when there is no flow in case water is wasted when the flow is turned on again.
- **Taps left running**
A tap should not be left running unattended.
- **Hanging buckets**
Users should be discouraged from hanging their buckets on the taps whilst collecting water. This practice can weaken the tap/standpipe joint and damage or break-off the tap.

- **Drinking at the tap**
Drinking water directly from the tap should not be allowed. It is better to catch the water in the mouth 10 -15 cm from the tap spout, or to simply use a clean cup.

Water storage in the home

To avoid contamination of water in the home the following measures are recommended:

- **Protect containers**
Containers should be covered or placed upside down on a clean surface, or put on a drying pole, when they are not being used for water collection. It is good practice to have containers for the purpose of collecting water only.
- **Storage containers**
Specified containers should be used for the storage of drinking water only.
- **Drinking cup**
Keep a clean cup for drinking water from the pot to prevent contamination. Figure above shows how to protect the cup against dust and flies with the same piece of cloth used to protect the water in the pot.



4.2 User operation of a standpost supply

Control

Control over the use and condition of a standpost should be the responsibility of the user group through the Tap Committee. All users should be shown how to use the standpost and operate the taps properly.

If the supply to the standpost is not going to be left open all the time, the users, through the Tap Committee, need to decide on the opening and closing times.



In one night a dripping tap will waste many buckets of water

Taps

Taps need to be used with care. A tap has a rubber washer which acts as a seal to stop the flow when the tap is closed. It should never be necessary to close a tap with force. If force is needed, it may mean the washer needs replacing or there could be other problems. The caretaker should be informed.

Simple advice to users can lengthen the life of taps and so save money. All users should be shown the correct way to open and close taps. Users must be made aware that if the tap is not properly closed the meter will measure all the lost water which will lead to higher water bills. Users should teach children how to open and close taps in the correct way.

Washing

Washing clothes and bathing at the standpost should not be allowed as the waste water will cause very muddy and wet conditions. Separate washing facilities could be provided but this will depend on people's washing habits and preferences in each case. Washing facilities, such as clothes washing slabs, can be positioned at a convenient but safe distance away from standposts to separate the two activities of collecting water and washing. An efficient method of draining waste water is necessary.



The design and the users

The design of washing slabs is important and should involve the users. There are several issues to consider, such as the height of the washing slab (both adults and children), local washing practices, including the use of soap.

Security

Security of the standpost and accompanying facilities can best be supervised by the user community living nearby. Taps can go missing and standposts damaged through children playing, theft and vandalism. Users are in the best position to take responsibility for security of their own standposts.

Animal drinking troughs

This requires careful consideration by all users. Directing spilt water to an animal drinking trough is one way of disposing of waste water. However, such a facility, especially at the height of the dry season, could become a major animal watering point if no other sources were available. This might cause problems.

Adequate fencing is necessary to separate the animals from the standpost area. Water should not be allowed to stand for a long time and so there should be a simple method of draining the water from the trough.

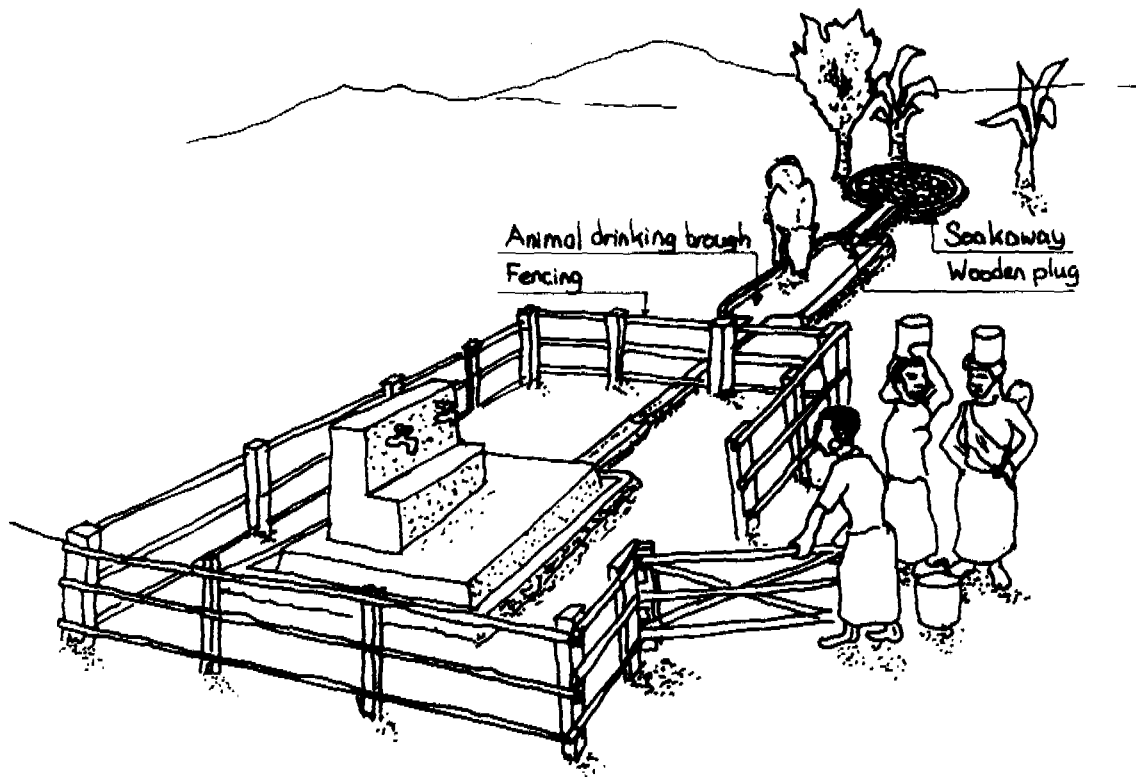

CONSIDER:

- Who should benefit?
- Which animals?
- How much does watering take priority in the collection of water for domestic uses

4.3 Preventive maintenance

Preventive maintenance is the regular checking and servicing of parts to reduce breakdowns and lengthen the life of individual components. Individual components reviewed are:

- Standpost
- Distribution system
- Water source and intake.

The following preventive maintenance measures are recommended.

Standposts

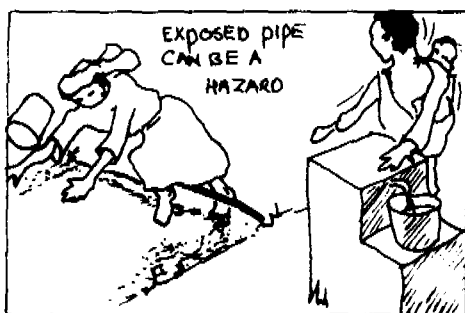

- **Service pipe**
Water is supplied from the distribution main to the standpost by a service pipe.

Checklist

Soil cover: The service pipe should be buried along its length. Any exposed lengths of pipe should be covered in soil. An exposed pipe around a standpost can be a hazard to users, see figure above.

Leaks: The service pipe should be inspected for leaks by walking from the standpost to the main and back. Long pipe routes should be marked.

A leak causes two main problems:

- Wastage of water resulting in pools of unhealthy muddy water around the pipe and standpost.
 - Decrease in water pressure at the taps resulting in a longer time to fill containers.
- SO
- Regular checking of a service pipe will prevent small leaks from becoming big leaks, if found in time.

- **Meter/valve box**

The meter/valve box is a chamber built around the valve, or valves, controlling flow to the standpost. The chamber will also contain a water meter if the supply is metered.



Checklist

Box construction: The chamber should be checked for cracks in the walls. A lockable cover is usually placed on top of the chamber to prevent unauthorised operation of the valve and tampering with the meter. The Tap Committee need to buy a new lock if it is damaged.

Meter readers: Meter readings should be compared from time to time and any large variations checked against normal usage. If there is any doubt about the accuracy of the meter readings, the water agency should be asked to check the meter.

Valve: The valve should be checked for correct operation. The caretaker, or person who controls the supply, should know how many turns of the handle are required to fully open the valve. If the number of turns reduce it could mean the valve is becoming blocked and needs cleaning or repair. Check for leaks from around the valve spindle and at the pipe joints. Section 4.4 covers the repair of leaks. Leaks that cannot be repaired should be reported to the water agency.

- **Taps**

The type of tap commonly used at standposts is the screw-down tap, also known as a bib-cock. The basic principle of this type of tap is that the flow of water is regulated by opening and closing two matching surfaces. One of the surfaces has a rubber washer attached to make a watertight seal.

Checklist

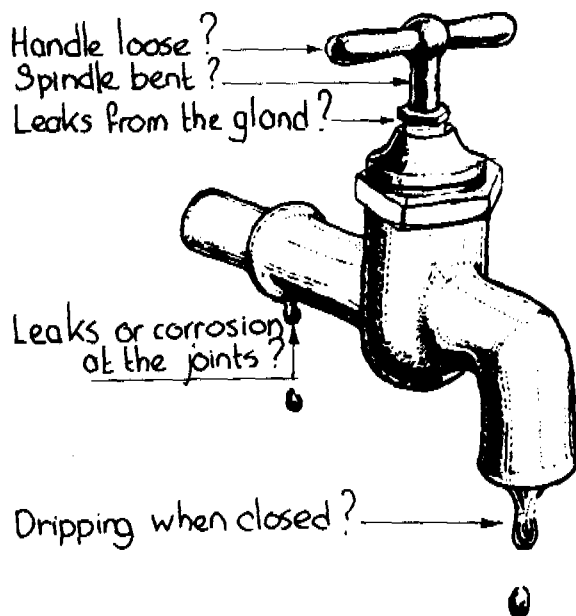

An easily turned handle but the tap does not work:

- Loose handle - fix handle.
- Spindle threads are worn - replace the tap.

A stiff tap:

- Bent spindle or damaged threads - replace the tap.
- Tight gland nut - loosen the nut.

Water dripping from around the spindle:

- Loose packing - tighten the gland nut.
- Worn packing - replace the packing.

A corroded joint between pipe and tap:

- Remove tap and inspect - clean or re-cut the thread and replace the tap.

Water dripping from a closed tap:

- Sand and dirt in the system - clean the tap.
- A worn, damaged or hardened washer - replace the washer.

Section 4.4 covers the replacement of a washer and gland packing, and other repairs in detail.

- **Platform, standing area**

A standpost should include a concrete slab, steel bars, or equivalent, to place containers for filling. This is sometimes called the bucket stand.

The concrete standing area is the area in front of the standpost which collects any spilt water and directs it to the drain.

- **Drain**

A drain, or run-off channel, is designed to carry spilt water safely away from the standpost to a soakaway, or garden. It must therefore be kept clear and in good condition to avoid pools of waste water.

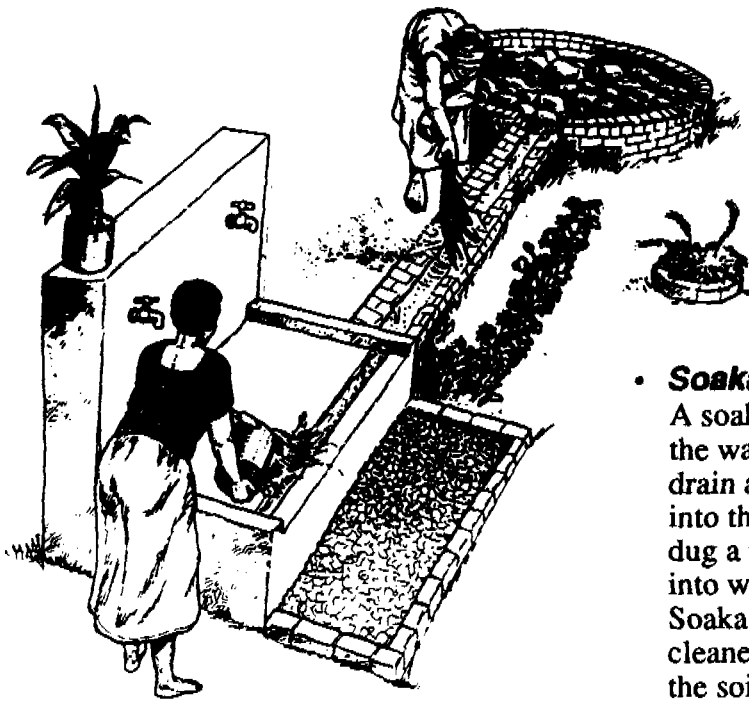

- **Soakaway**

A soakaway is designed to receive the waste water from the standpost drain and allow the water to soak into the ground. It is usually a pit dug a metre, or so, into the ground into which stones are placed.

Soakaways must be occasionally cleaned to allow water to penetrate the soil. Soakaways will not work in clay soils and it is a mistake to dig the pit deeper unless a different, more absorbent soil, can be reached. Alternative means of using up the waste water then have to be found.

- **Surroundings**

Generally, the standpost surroundings should be kept clean. Pools of standing water should not be allowed to form. Many diseases, such as hookworm, roundworm and malaria can be encouraged by a damp and wet environment.

Some general remarks

- ***Small cracks***

Small cracks in concrete can soon become big cracks unless they are repaired quickly. Cracks should be repaired because:

- Smooth concrete is easier to keep clean and water flows more freely.
- Small pools of water in cracks can become breeding grounds for insects, such as mosquitoes.

- ***Gardens, trees***

Gardens and the planting of trees are a possible way of using the water. The local forestry department will be able to advise on suitable trees. Planting trees also has the advantage of eventually providing shade. A garden may create problems, however, as it may need more water than the normal waste flow. Watering the garden may then increase the water bill. Therefore, users must decide on how the garden water is to be controlled and who is to benefit from the garden to avoid disputes later.

- ***Animals***

Alternative arrangements can be made for animal watering, such as properly maintained animal drinking troughs.

The standpost area should be fenced in villages where wandering animals are common.

Distribution system

Responsibility

Community members may not have direct responsibility for the distribution system but they can still play a preventive maintenance role by looking out for signs of potential problems. Problems can be reported to the link person with the water agency: scheme attendant, caretaker or committee member.

Someone, preferably within the community, should have the responsibility of regularly walking the route of the main pipeline, or pipelines, to inspect the pipes and fittings. More frequent walks can be taken during high risk periods, for example after heavy rains. A small problem noticed in time can prevent major problems developing later.

Pipes

Checklist

Bury pipe:

Buried sections of pipe should always have good soil cover and be protected from damage, such as vehicles driving over them. It is particularly important to cover PVC pipes because it can be weakened by sunlight.

Erosion:

Over a period of time, soft soil used in the backfilling of pipes can be eroded during periods of intense rainfall. This action can quickly form gulleys which, if not checked, can wash away pipes. Erosion around pipes should be reported straight away to the water committee and action taken to replace the soil and protect the pipe. Backfilled soil can be stabilized by the planting of grass and vegetation along the pipeline route. Stream or gully crossings can be washed away by strong flows. Pipe supports and anchor blocks should be regularly checked for movement and reported if found weak.

Leaks:

Leaks in the distribution system should be reported.

Pipeline marking:

Pipe routes should be marked, especially in areas where pipes cross farming land. Agreements should be reached with farmers so that pipelines are either buried very deep or farming is not allowed next to pipeline routes. Regular checks are needed to ensure agreements are being kept and the pipeline markers can still be clearly seen.

Valves

Valves should be opened and closed periodically to ensure they can operate properly. Valves should not be closed quickly as this could induce a high pressure in the pipeline if the flow is suddenly shut-off. This is called 'water hammer' and, in some cases, can have the effect of damaging pipes and fittings.

Valves should not be over-tightened as this could damage the valve seat, or threads. A valve should not be snatched shut but slowly closed, until the flow is stopped, and no more.

Checklist

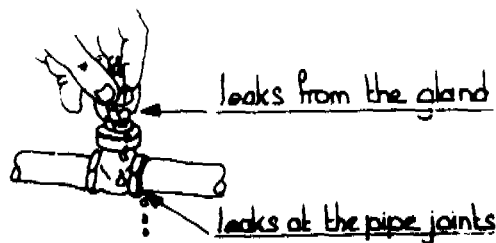

Valve leaks

Valve leaks commonly occur on the gland and at the valve/pipe joints;

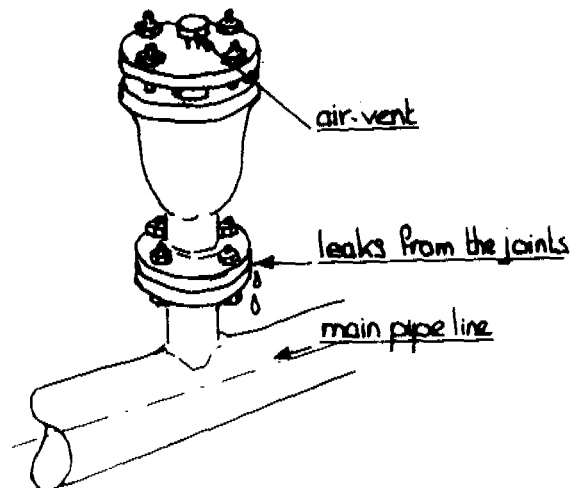

Air-valves

Air-valves, if fitted, may leak at the joint gasket on the T-piece between pipe and valve.

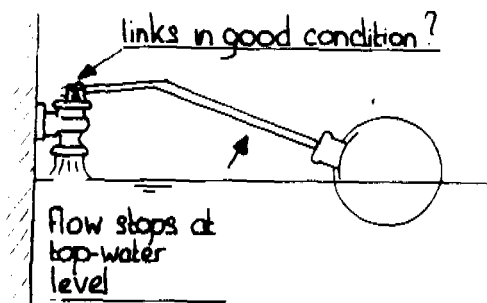

Float valves

Float valves on storage tanks and break-pressure tanks should be checked to ensure they:

- Float and are not punctured.
- Shut-off the supply when in the closed position.

Tanks

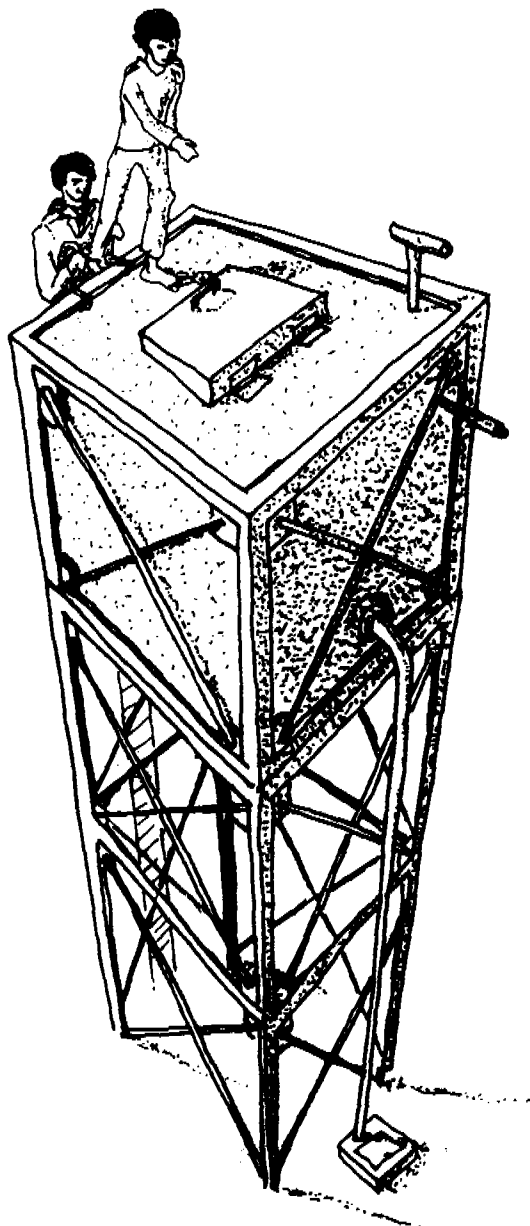

Checklist

For all tanks, check for the following:

- Leaks:** From below the tank
Through cracks in the walls.
Where pipes pass through tank walls.
- Overflow:** Clear?
- Airvents:** Clear?
- Covers:** In place?
- Tank surroundings:** Clean?

Water should not be drawn directly from tanks. This can happen in the case of break-pressure tanks because of their often low height. Water should only be taken from the taps at the standposts. Covers should be securely fixed on all tanks. This also prevents pollution from dust, animals, birds, etc.

Water source and intake

Water source protection

Water supplied through the distribution system should be safe to drink. The first step to ensure the safety of water is to protect the surface or groundwater source. The following should not be allowed:

- Animals near the source.
- The collection of water directly from the source.
- Bathing or clothes washing near the supply and especially upstream of a water course.
- Defecation near the source, and especially upstream of a water course, including pit latrines and septic tanks.
- The use of chemical fertilizers and pesticides by farmers in the source area.

Keep the source surroundings clean. Periodic checks of water courses feeding the supply should be undertaken to check for possible contamination.

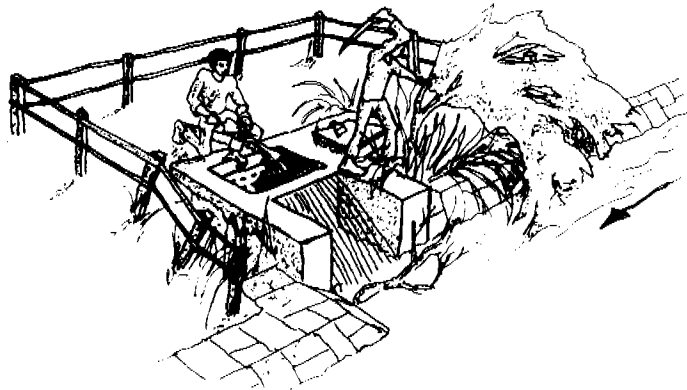

Intake cleaning

A stream or river intake will need periodic cleaning and the community can assist in this work. For an example of an intake-construction, see page 10.

Checklist

- Screens:** Coarse screens at the head of the intake may need the removal of large solids like tree branches. Finer screens will also need cleaning.
- Silt:** Intake chambers need occasional de-silting, depending on the time of the year.
- Vegetation:** Grass and bush around the intake structure will need cutting back during the wet season.
- Fencing:** Fence around the immediate intake area to protect it from contamination by animals.

4.4 Minor repairs

In this section only the minor repairs relating to the standpost and service pipe will be covered as they are the immediate responsibility of the community. However, community members should be encouraged to assist water agency staff in other repairs which they may eventually be able to take over.

Standpost taps will require most attention. It is better to try and repair taps before they become badly damaged and have to be replaced.

Tap re-seating

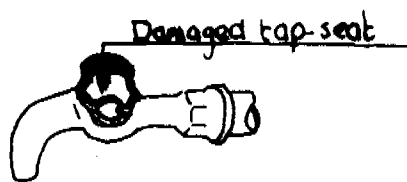

Check the seat of a tap when it is dismantled. If it is smooth and shiny, without any grooves or ridges, then the tap can be reassembled. If the seat shows signs of wear or damage it will have to be re-cut.

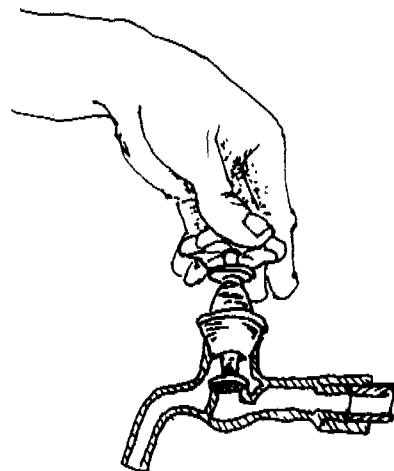
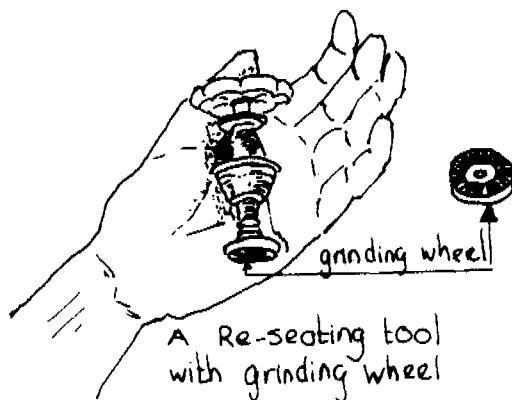

Use a re-seating tool. The grinding wheel is for smoothing the seat. The re-seating tool has to be used carefully. Do not remove too much metal but only enough to smooth the seat.

After using the re-seating tool, protect your eyes and blow out any metal particles. Check the seat but be careful not to put your finger on it as it may be sharp and it could give a nasty cut.

Tap washer replacement

A spanner and a spare washer are needed for the replacement of a worn out washer. The figures show the parts of a screw-down tap and how to replace a tap washer. The spare washer should be made of vulcanised rubber, leather or plastic (neoprene). Ordinary rubber should not be used, as it is not hard enough.

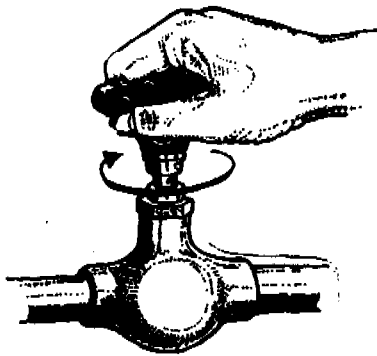

Turn off the valve of the Service pump

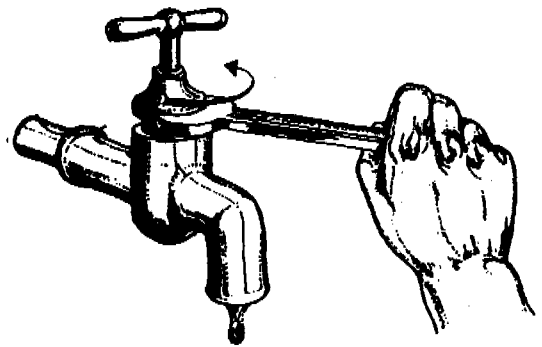

Unscrew the tap

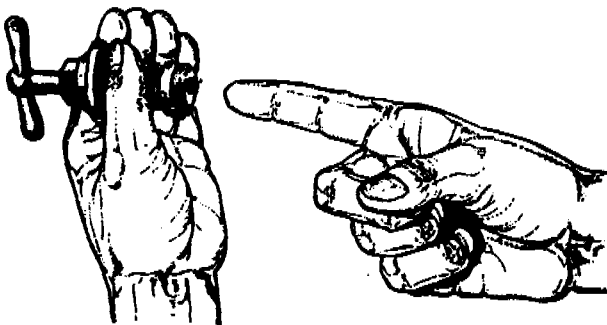
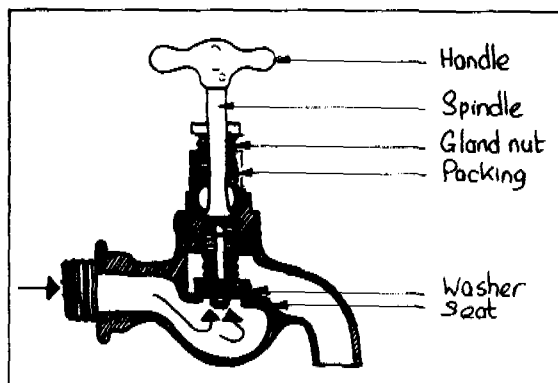

Remove worn washer

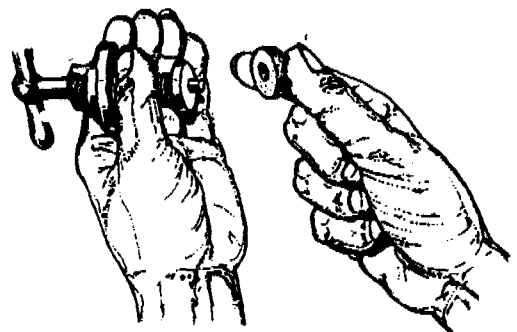

Replace washer

Leaking gland

Water leaking from the gland around the spindle of a tap or valve is caused by worn-out packing. The gland packing can be tightened by carefully screwing down the gland nut just enough to stop the leak, no more. However, as the packing gets older there will come a time when the gland nut cannot be tightened any further and the packing will need to be replaced.

Hemp, with a soft graphite grease, can be used to make a new packing. When the gland nut is tightened the packing is compressed making the joint watertight.

Replacement of the packing is a simple procedure as follows:

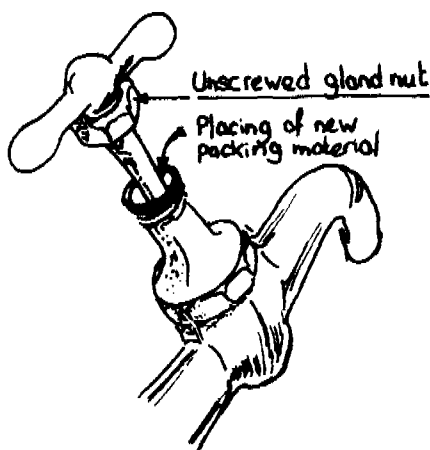

- Unscrew the gland nut.
- Remove the old packing and clean around the spindle.
- Place new packing material.
- Screw back the gland nut.
- Slowly tighten the gland nut until there are no leaks past the gland.

Some taps have an O-ring seal instead of a gland packing. In this case, if there is a leak past the spindle, the rubber O-ring must be replaced.

Fitting a new tap

It may not be possible to repair a tap and then it will be necessary to change it completely. Dismantling of the tap from the connecting pipe has to be done carefully so as not to damage the pipe threads or bend the pipe.

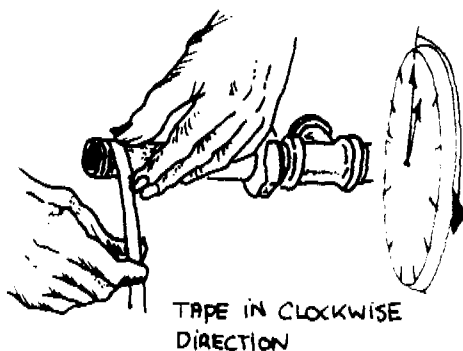

The threads of the pipe need to be cleaned with a steel brush to remove any rust and remaining old jointing compound.

To join the new tap, either flax or hemp with a jointing compound or a white plastic tape known as PTFE is used. The flax, hemp or tape should be wrapped around the thread in a clockwise direction. The tap should be screwed on tightly but care should be taken to hold the pipe with a wrench and not to rely on the concrete to hold the pipe steady or the concrete may break.

Service pipe

Several different pipe materials may be used in a piped water supply system. Common materials used for service pipes include: PVC (PolyVinyl Chloride), GI (Galvanized Iron) and PE (PolyEthylene).

To repair a leak in a service pipe take the following steps:

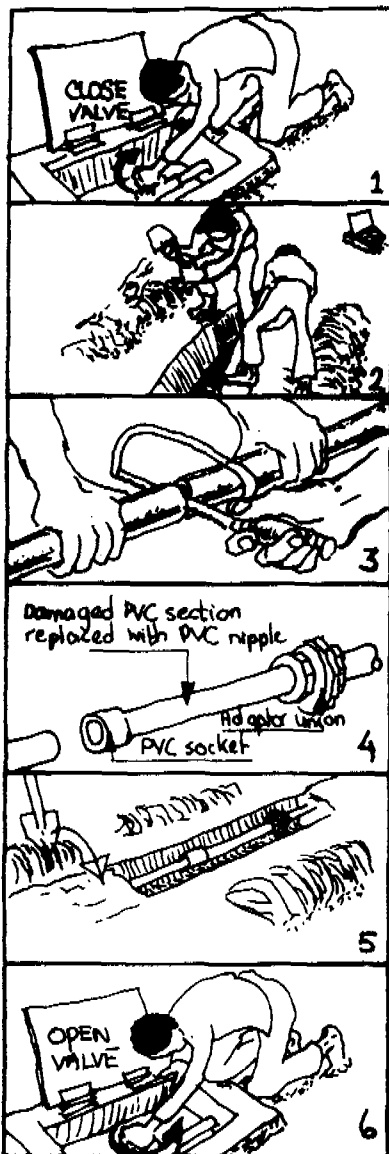

1. Turn off the water at the nearest control valve upstream of the leak.
2. Excavate and expose the leaking section of pipe.
3. Cut out the broken length of pipe.
4. Replace with a new section of pipe.
5. Following re-connection, partially backfill the pipe leaving the joints exposed.
6. Carefully open the control valve to check there are no leaks at the joints.
7. Backfill and compact the trench.
8. Mark the position of the pipe (stones, pegs, etc.).
9. Record the repair (date, location, type of repair, materials used, etc.).

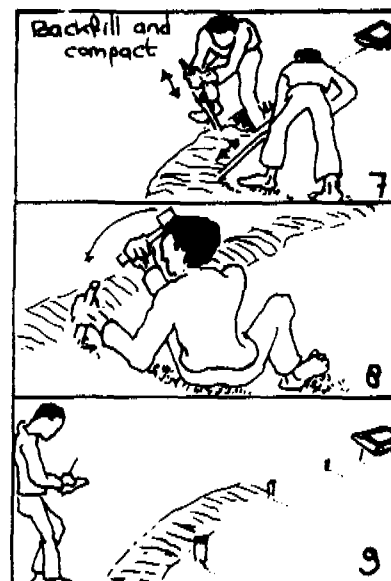

Service pipe valves

The valve on the service pipe to control flow to the standpost may be either a screw-down type valve (sometimes called a globe valve or stop-cock) or a small gate valve. Each valve operates in a different way.

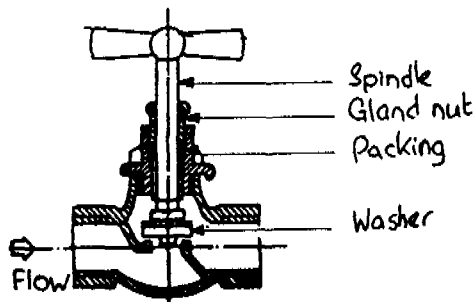

- **Stop-cock**

A stop-cock is similar in action to a screw-down tap. The seal may be made between a metal seat and a rubber washer, as in the case of a tap, or between two metal surfaces. The seat can be repaired using a re-seating tool in the same way as described for a screw-down tap. It is important to install a screw-down valve the correct way in a pipe for it to work properly. The direction of flow is shown on the outside of the valve.

- **Gate valve**

A gate valve seals the flow of water with a solid metal wedge. There are no parts inside a gate valve that the community can repair. It can only be cleaned if silt or sand prevents it from fully closing. Movement of the valve wedge up and down may remove any build up of silt on the valve seats.

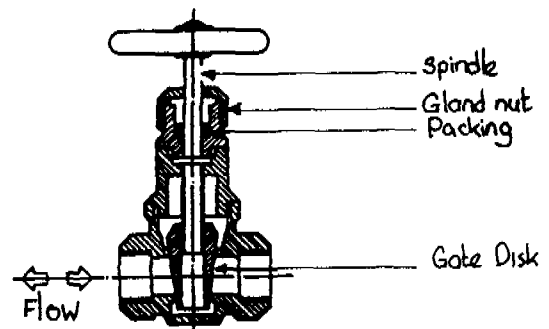

Both valves rely on gland packing to prevent the flow of water past the spindle, sometimes called the valve stem. A leaking gland can be repaired in the same way as for a screw-down tap.

Cracks in concrete

Standposts, platforms and run-off channels may develop cracks in the concrete.

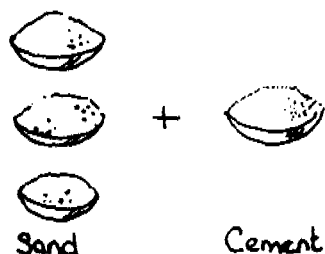

Cracks in concrete structures should be repaired with cement mortar which consists of a mix of 3 parts of sand and 1 part of cement by volume. Only enough water should be added to make the mixture workable. Too much water weakens the mortar.

- **Cleaning**
All loose material should be removed from the crack and the crack area cleaned, as far as possible, so that the new mortar can bind onto a clean, solid surface.
- **Water**
The old concrete should be splashed with water around the repair site so that the mortar will not dry out too fast.
- **Fresh mortar**
The fresh mortar can be applied with a mason's trowel and smoothed with a flat wooden board, called a float.

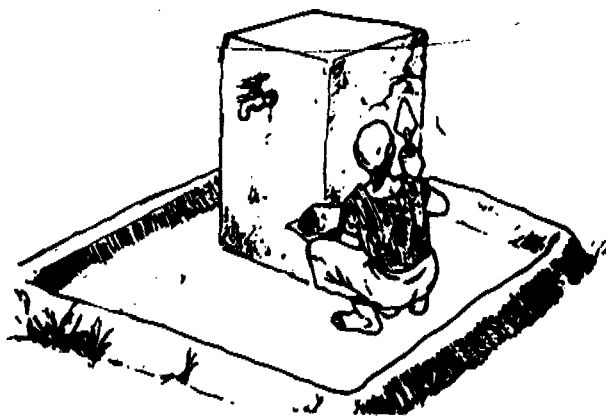

IMPORTANT: NO DRYING OUT

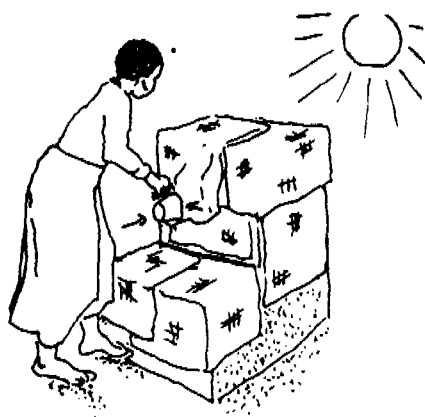

It is important that the repair is not allowed to dry out too fast. This is because the cement mortar needs water to gain strength and this can take a few days. If the repair dries very quickly in the sun it will soon crack again and the effort will have been wasted. Therefore, the repair should be kept wet for a few days by splashing water on it from time to time and then covered with old cement bags, sand or large leaves until strong.

Cracks in the concrete walls of water tanks need special attention and should be referred to the water agency for repair as soon as they are noticed.

Caretaker checklist for preventive maintenance and minor repair

The checklist summarises both the preventive maintenance and minor repair tasks for which a caretaker may be responsible. The checklist can be combined with a visual reminder of the problems.

Check	Action
Service pipe Pipe covered? Pipe leaking?	Cover pipe with soil Repair or get help
Meter/valve box Walls cracked? Cover in place? Check lock	Repair with cement mortar Replace cover Replace lock if defective
Meter Meter recording? Leaks?	Report if meter is suspect Report if leaking
Service pipe stop valve Valve stiff? Gland leaking? Joints with pipe leaking?	Clean, repair, or report a) tighten gland nut; b) replace packing if worn. Tighten joints, repair, or report
Standpost Surfaces clean? Cracks? Poor drainage? Clear soakaway?	Clean if required Repair with cement mortar Identify problem and either: a) replaster surfaces to drain freely, or b) discuss problem with the users Clean and replace stones if required
Taps Inspect for leaks Check handles Joint with pipes Monitor correct use by all users Test flow from tap Taste water and check the colour	Replace tap washers where necessary Tighten gland nuts where required or replace gland packing Fix any loose handles Clean or re-cut threads where necessary Advise users on correct tap use If low flow: check service pipe stop valve is fully open and/or check for leaks Report any changes immediately
Records Record all repairs, including spares and materials used.	

4.5 Major problems

Although most major repairs are likely to be beyond the capability of the community, they can still play a role in assisting the water agency.

Reporting

A system of reporting to the water agency about major problems should be agreed upon with the community. With full and correct information about the problem the repair team can prepare themselves with the correct tools, spares and equipment before leaving their base. Repairs can then be made quickly to resume normal supply.

Major pipe leaks

In the case of major pipe leaks the community can provide labour for:

- Digging.
- Transporting and handling pipe.
- Backfilling and compacting pipe trenches.
- Marking the pipe route (with stones, etc.).
- Protecting and stabilizing backfill by planting grass and vegetation.

Intake damage

In times of flood, intakes can be damaged by fast flowing streams and rivers, and the debris which is carried by floodwaters. Intake screens can become blocked and chambers damaged. Weirs may be partly washed away. The community can assist in repairs by:

- Removing debris.
- Mixing concrete for repair work.
- Making arrangements for a temporary or rationed supply while work is carried out on the intake.

Treatment problems

If there are problems with the treatment works, the first most important step the water committee should take is to inform the consumers that the water delivered to the standposts is not of the usual safe quality. Advice should be given through the committee, after consultation with the water agency, on how consumers should take care of their water. This should be done as soon as possible to avoid a sudden outbreak of illness which could follow an abrupt change in water quality.

Any assistance to the water agency will depend on the type of problem and the treatment process involved. If any repairs are to be carried out the community could help in the cleaning of tanks and filters.

GLOSSARY

The words described in the following list will be used as standard terms in this publication.

(N.B.: the definitions will standardize on key words and then include: "*In your country/region may be called, or instead*")

Agency	See 'water agency'.
Air valve	A valve which operates automatically to release air from a pipe system. There are two types of air valve, i) to allow air into or out of a pipe when it is emptying or filling, or ii) to release small amounts of air which become trapped in a pipe system.
Air vent	An open pipe, which may be screened, to allow air to circulate in a closed water tank.
Branch main	A pipeline taking water from the main pipeline of a piped system to a particular section of the community served.
Break-pressure tank	A small tank located in a distribution system to prevent high pressures in a pipeline.
Caretaker	A trained member of the community who undertakes regular preventive maintenance and minor repair work around the standpost and taps.
Communal water point (CWP)	A place where members of a community can collect water, usually from a standpost.
Community water supply (CWS)	A water supply serving a particular community.
Gate valve	A stop valve which is used to open and close flow in a pipeline by screwing a gate across the bore of the pipe. The gate is usually a wedge shape. <i>In your country/region a gate valve may be called a sluice valve instead.</i>
Gravity-flow water supply	A water system that requires no energy to operate as the water is propelled by gravity alone. No pumps are needed, therefore operation and maintenance is simplified.
House connection	Piped water connection to tap(s) within an individual home.

Hygiene	Clean practices which promote health, including: hand-washing, bathing, brushing teeth, food handling and maintaining a clean household environment, including safe disposal of human and animal waste (see sanitation).
Mains	The main water pipeline in a distribution system.
Major repairs	Repairs needing skilled workers, certain tools, equipment and materials which therefore requires the water agency or a private contractor to carry out, such as major pipe bursts, cracked storage tanks, pump failures, and so on.
Minor repairs	Repairs which can be carried out by members of the community, usually on the service pipe, standpost and taps.
Neighbourhood tap	Piped water connection to a tap from which a group of people draw water (see also yard connection).
Piped supply	A water supply system conveying water by pipes some distance from the source to a number of distribution points.
Public standpost	A standpost where use is not restricted in any way to a particular group or community. (see also standpost and yard connection).
Public spigot	See standpost.
Public fountain	See standpost.
Preventive maintenance	Routine maintenance activities carried out by members of the community which prevent major problems developing at a later stage. Activities involve: regular checking of components and minor repairs.
Reservoir	See storage reservoir.
Sanitation	Sanitation may either refer to: the safe disposal of human excreta and solid waste; or, in addition include the hygienic use and care of an improved water supply.
Scheme committee	A committee of representatives who come from the villages served by a water supply scheme.

Screw-down tap	<p>A common water tap which is operated by screwing a spindle to open and close two matching surfaces, one of which is a rubber washer.</p> <p><i>In your country/region a screw-down tap may be called a bib-cock or faucet instead.</i></p>
Screw-down valve	<p>A screw-down valve operates in a similar way to a screw-down tap but is used to open and shut flow in a small pipeline, such as a service pipe supplying a standpost.</p> <p><i>In your country/region a screw-down valve may be called a stop-cock or globe valve instead.</i></p>
Silt box	<p>A concrete chamber, located at the intake of a system, to prevent silt getting into the distribution pipes.</p> <p><i>In your country/region a silt box may be called a silt trap, or silt chamber instead.</i></p>
Standpost	<p>A tap, or taps, and solid supporting structure designed for use by a number of families for domestic water supply. A standpost is usually a concrete or masonry structure; metal or timber post; equipped with a standpipe (vertical water pipe) to which one or more taps are attached.</p> <p><i>In your country/region a standpost may be called a standpipe, tapstand, fountain, or spigot instead. To emphasize the public can use the standpost it may be called a public, road, communal, or community standpost, fountain or spigot.</i></p>
Storage reservoir	<p>This term may refer to either a man-made lake of water, or a storage tank serving a distribution system.</p>
Storage tank	<p>A tank which stores water to even out the demand during the day and to provide a reserve of water in the event of a breakdown of the supply.</p> <p><i>In your country/region a storage tank may also be called a service reservoir, balancing tank or reservoir, or storage reservoir.</i></p>

Tap committee	A committee made up of users of a particular standpost who are responsible for the care and maintenance of the standpost and associated fittings and surroundings.
Unprotected supply	A water supply which has not been adequately protected against contamination.
Village water committee	A committee formed to manage a village water supply.
Wash-out	A valve or pipe cap which can be opened to drain water from a pipe or tank.
Waste water	Spilt or used water.
Water agency	The organization with overall responsibility for a water supply. <i>In your country/region the water agency may be a government department called a water authority or corporation, or it may be a private water company.</i>
Water meter	An instrument fitted in a pipeline to measure the flow of water through it.
Yard tap/connection	A tap or standpost located in a courtyard and serving a family living together on one homestead, or a group of family units located around a common courtyard.

APPENDICES

A.1 Gravity flow system

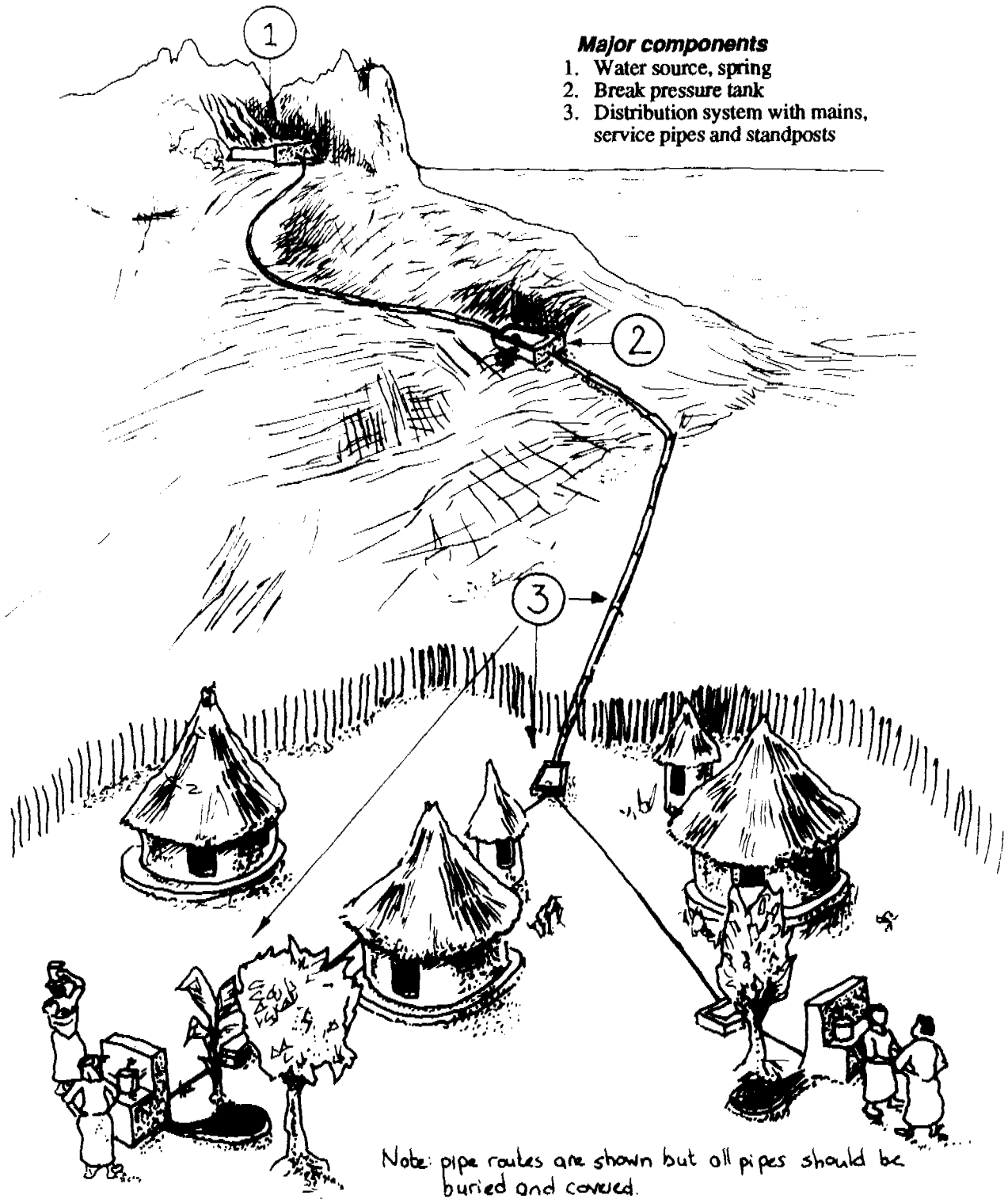

A.2 Water treatment

Storage of water near the intake can have several useful functions and is a method of treatment in itself. Storage provides a reserve of water in case the system breaks down, or needs to be shutdown. Shutdown of an intake may be desirable in periods following heavy rainfall to avoid introducing into the system heavily silt-laden water and debris from a water course in flood.

Pre-treatment by 'roughing', or gravel filtration will reduce silt loads to acceptable levels. These techniques do not require much operational care. No addition of chemicals is needed.

Storing water to allow settlement of the suspended solids is also possible but less effective. The rate of settlement of suspended solids can be increased by the addition of chemicals. However, for many small schemes this may not be appropriate due to the problems of chemical supply and the more complex operation and maintenance procedures involved.

Guidelines for the selection of a water treatment system for surface water in rural areas are given in the table on page 77. The appropriate treatment is selected according to the quality of the raw water.

Slow sand filtration is the most appropriate method of water filtration treatment for small schemes in developing countries. It is a relatively simple, efficient and reliable technique. Operation and maintenance of a slow sand filter must be carefully carried out but it is not complex and local operators can be trained to adequately operate and maintain the system. Community members can be involved in the care of a slow sand filter such as in the periodic cleaning required. Regular inspection and supervision by appropriate water agency staff is necessary to ensure the correct functioning of the treatment process.

Chlorination is normally a safety measure to make sure that heavily polluted water is safe when it enters the supply system. It also prevents the growth of bacteria in tanks and the system as a whole. There are methods of chlorination which have been developed for use in small-scale plants to minimise the problems of operation and maintenance. They usually avoid the use of moving parts but, whilst simple, they still require careful operation to ensure water entering the system receives the correct chlorine dosage.

Each extra stage of treatment will, of course, increase the complexity of the overall operation and maintenance requirements of the water supply system. The systems mentioned here are all relatively straightforward but require regular supervision to ensure they operate, and are maintained correctly.

The major components are: a protected spring; break-pressure tank; main pipelines; storage tank; service pipes; standposts.

Guidelines for the selection of a water treatment system for surface water in rural areas.

Table: Guidelines for surface water treatment

Average raw water quality	Treatment required
Turbidity: 0-5 NTU Faecal coliform *MPN:0 Guinea worm or schistosomiasis not endemic	<ul style="list-style-type: none"> • No treatment
Turbidity: 0-5 NTU Faecal coliform *MPN:0 Guinea worm or schistosomiasis	<ul style="list-style-type: none"> • Slow sand filtration
Turbidity: 0-20 NTU Faecal coliform *MPN:1-500	<ul style="list-style-type: none"> • Pre-treatment advisable • Slow sand filtration • Chlorination if possible
Turbidity: 20-30 NTU (30 NTU for a few days) Faecal coliform *MPN:1-500	<ul style="list-style-type: none"> • Pre-treatment • Slow sand filtration • Chlorination, if possible
Turbidity: 20-30 NTU (30 NTU for several weeks) Faecal coliform *MPN:1-500	<ul style="list-style-type: none"> • Pre-treatment • Slow sand filtration • Chlorination, if possible
Turbidity: 30-150 NTU Faecal coliform *MPN:500-5000	<ul style="list-style-type: none"> • Pre-treatment • Slow sand filtration • Chlorination, if possible
Turbidity: 30-150 NTU Faecal coliform *MPN:5000	<ul style="list-style-type: none"> • Pre-treatment • Slow sand filtration • Chlorination
Turbidity: 150 NTU	<ul style="list-style-type: none"> • Detailed investigation and possible pilot plant study

* Faecal coliform density per 100 ml

Adapted from: IRC (1987). Slow Sand Filtration for Community Water Supply, TP24.

A.3 Gravity Scheme Monitoring Form

Only one extract is shown to indicate a format and the type of information which would be useful to collect. Additional sections could cover storage tanks, distribution pipelines, service pipes and standposts. A section for comments would give the inspector the opportunity to remark on items not covered on the form and to include comments by committee members, caretakers or scheme attendants, and users.

GRAVITY SCHEME MONITORING FORM

Visit date: _____ District: _____ Village: _____
 Group scheme: _____ Group number: _____

Information from scheme record

Spares purchased since last visit:

Spares Description	Quantity	Price	Spares Source
_____	_____	_____	_____
_____	_____	_____	_____
_____	_____	_____	_____

Date scheme was last checked: _____

Has the scheme been working without a breakdown since last visit: YES/NO

If there has been a breakdown, type of breakdown: _____

Physical scheme check

Water committee participants taking part: CHAIR/DEPUTY/SECRETARY/MEMBER

Scheme attendant participated in check: YES/NO

Intake

Concrete good: YES/NO
 Weir intact: YES/NO
 Clean: YES/NO
 Covers in position: YES/NO
 Wash out & gate valve function: YES/NO

Main pipeline

Pipelines covered: YES/NO
 Supports good: YES/NO
 Pipemarkers intact: YES/NO
 Wash outs function: YES/NO
 Air valves function: YES/NO
 Gate valves function: YES/NO
 Valve chambers clean: YES/NO
 Covers in position: YES/NO

Break-pressure tanks

Concrete good: YES/NO
 Tank clean: YES/NO
 Float valves function: YES/NO
 Wash outs function: YES/NO
 Gate valves function: YES/NO
 Overflow clear: YES/NO
 Cover in position: YES/NO
 Clean around the tank: YES/NO