

INTERNATIONAL SEMINAR ON DISINFECTION  
WITH MIXED OXIDANTS GENERATED ONSITE

PAHO

LIMA, PERU

DECEMBER 5 - 12 1987

LIBRARY, INTERNATIONAL REFERENCE  
CENTRE FOR QUALITY WATER SUPPLY  
AND SANITATION (IQC)  
P.O. Box 9800, 2509 AD The Hague  
Tel. (070) 214911 ext. 141/142

RN: SSN 3733 254.9 87IN  
LO: ~~PAHO~~ 87

*THE JOHNS HOPKINS UNIVERSITY*  
*SCHOOL OF MEDICINE*

*DEPARTMENT OF PEDIATRICS*  
*Division of Infectious Diseases*  
*(301) 955-3271*

*Please address reply care of*  
*THE JOHNS HOPKINS HOSPITAL*  
*BALTIMORE, MARYLAND 21205*

Baltimore, June 29 , 1987

Doctor  
DONALD S. SHARP  
Associate Director  
Water Supply and Sanitation  
Health Sciences Division  
International Development Research Center (IDRC)  
P.O. Box 8500  
Ottawa, Canada K1G - 3H9

Dear Doctor Sharp:

Thank you for sending me the guidelines and application forms for research support and general information about IDRC. We appreciate your encouragement and support in our research efforts.

As I told you on the phone, Professor Maria Yolanda Ramirez and I, have decided to continue with the research activities and the multidisciplinary group that we established a few years ago in Cali, Colombia, which is based at the University of Valle. Under our leadership, the group involves research workers from the School of Engineering and the School of Medicine and Health Sciences at the University, as well as from the Cali Regional Health Unit, which is the branch of the Ministry of Health in Cali. We are in the process of formalizing a joint program between the University of Valle and the Johns Hopkins University, following our research experience for the last two years at Johns Hopkins.

We are proposing a whole package of investigations in the area of diarrheal diseases and environmental health, to be accomplished in the next five years. Our plan consists of the following studies:

1. The first study will evaluate an oxidant generator which the Pan American Health Organization (PAHO) is willing to introduce in small communities of developing countries. The PAHO device, which disinfects bacteria, viruses and parasites, should improve the quality of the water supplies of such populations, which do not have access to a real aqueduct. This study will be submitted for funding to PAHO and will be conducted in Cali, Colombia.

2. The second study will evaluate two simple methods for improving water quality, and thereby improving child health, in

periurban communities in Cali, Colombia.

We will evaluate the disinfection potential of a simple slow sand filtration system and the on site oxidant generator device by themselves and both together against a natural non-treated water supply. Water supplies will be examined for microbiological and parasitological quality. Parallel to the water interventions, we will measure the health impact of these water treatments, among children from 6 to 18 months of age. Fecal contamination indicators and specific pathogens will be quantified at the stages of ingestion, infection and excretion. Diarrheal disease rates will also be measured. This is the study to be submitted to IDRC for funding.

Besides our multidisciplinary group, which involves, sanitary engineers, microbiologists, virologists, immunologists, epidemiologists and pediatricians, we will have two consultants : Dr. Vincent P. Olivieri, from the Environmental Health Engineering Division, and Dr. Steven A. Esrey, from the Department of International Health, The Johns Hopkins University School of Hygiene and Public Health.

In about two weeks I will send you a pre-proposal describing the two- year study, which we plan to start by June 1988. The first six months will be dedicated to preliminary studies, then another six months for establishing the interventions, plus six months of evaluation and six months for data analysis and publication. The project will be performed in periurban communities that do not have access to the Cali's main water supply or aqueduct. Our research group has been working in four of these communities and a summary of the studies, in final form, will be submitted for publication in the PAHO Bulletin.

3. A third study will focus on behavioral changes as preventive measures of the Acute Diarrheal Diseases Syndrome. This particular project will deal with interventions related to excreta disposal, personal hygiene and food hygiene. We are considering several sources of funding for this study.

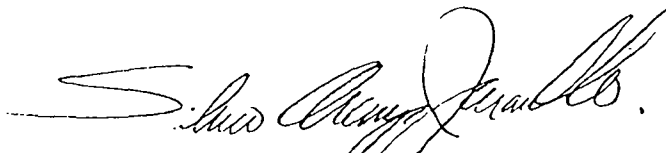
4. This will be a virological, bacteriological and immunological study which will include epidemiologic surveillance, distribution, attack rates, fluctuations etc, of the leading pathogens of the enteric tract in some specific areas of Cali, with emphasis on Rotavirus. Immunological studies of the community from the point of view of the response to Rotavirus infection plus the introduction and development of rapid diagnostic laboratory techniques and some preliminary studies on the molecular biology of these viruses, will also be considered. This project will be submitted to "Colciencias", the main Colombian governmental institution for research funding.

5. Based in the previous study we will perform a Rotavirus vaccine trial in Cali. For such a study we may go to NIH for funding or possibly to WHO.

As you can see, we want to have all research pieces together, in order to evaluate these different interventions as preventive measures of the Acute Diarrheal Disease Syndrome, under the ecological parameters of our developing country.

Finally, I plan to contact your representative in Bogota, before sending you the pre-proposal, in order to follow the appropriate channels. Thank you in advance for your patience and reviewing this outline. I would appreciate any suggestions or comments you may have at this time.

Sincerely yours,



SILVIO ARANGO-JARAMILLO

- ✓ c.c. Prof. Maria Yolanda Ramirez
- c.c. Dr. Vincent P. Olivieri
- c.c. Dr. Steven A. Esrey
- c.c. Dr. Silvio Gomez J.

DISINFECTION WITH MIXED OXIDANT GASES  
GENERATED ON SITE (MOGGOD)

A Progress Report of the PAHO Demonstration-Development Project

December 1987

*M. J. Colandrea*

## SYNOPSIS

In 1982 The Pan American Health Organization (PAHO) began promoting the development of technology for on-site generation of mixed oxidants for the disinfection of drinking water supplies for small and/or remote communities in Latin America and the Caribbean. For brevity this technology was given the acronym of MOGGOD, the term which will be used throughout the remainder of the article. The fundamental reason for PAHO's interest in development of a new disinfection technology when so many conventional methods and "appropriate technologies" already existed was for the simple statistical fact that more than 75% of all disinfection facilities in Latin America and the Caribbean have failed to provide continuous and adequate disinfection in spite of more than 20 years of efforts to develop human resources, institutions and supporting infrastructure. The basic concept behind this initiative is to use high level technology to develop simple, practical but effective disinfection methods which are targeted at removing the restrictions and problems peculiar to Latin America that have prevented conventional disinfection from being carried out.

In December 1986 PAHO with a 20% contribution from UNDP initiated the first phase of a demonstration project to introduce agencies and institutions of PAHO member countries to the MOGGOD concept and to enlist their support in the development of MOGGOD technology. It included the purchase of MOGGOD prototypes along with their shipment to participating countries in Latin America and the Caribbean for laboratory as well as field testing under the actual conditions which have led to the failure of existing conventional methods of disinfection. It is anticipated that the operational experience which is underway will not only familiarize the water supply sector with MOGGOD technology but also will lead to accelerated improvements and application of the devices.

The ambitious objective of developing innovative disinfection technology in the context of Latin America appears possible in light of the increased scientific knowledge and many technical advancements made in related areas over the previous decade. The project's rapid feedback of operational experience from the users to the developers has already resulted in a considerable number of significant improvements in design, methodology and technological understanding. MOGGOD disinfection to date has been at least as effective as chlorine in both the field and the laboratory. At this early stage of the project the results have been very encouraging and definitely

merit continuation of the effort.

#### BACKGROUND AND PROJECT JUSTIFICATION:

Although many of the small towns and communities of Latin America and the Caribbean have been served with community water systems and most national plans aim at increasing the water supply coverage in small and rural communities, the disinfection of that water has been neither adequate nor reliable; more often than not it is not even carried out. In PAHO'S workshop in May 1984 for the introduction of the new WHO Guidelines for Drinking Water Quality a participant survey indicated that more than 75% of the water systems in Latin America and the Caribbean were either inadequately disinfected or not disinfected at all. Subsequent studies and investigations indicate a somewhat higher percentage of failure.

This is one of the most serious problems affecting the health of the residents of small towns, rural areas and marginal urban areas. The importance of water disinfection has been proven in both theory and practice. It is a fundamental public health measure and wherever it has been carried out reliably and adequately has assured health benefits for the users of the water supply. There are more than 20 diseases related to drinking water supply. All of them are debilitating and some are deadly, placing a terrible handicap and economic burden on everyone but particularly upon the poor people who least can afford it. The most serious and numerous of these diseases can to a very large extent be prevented through adequate disinfection.

There have been numerous studies over the past 50 years on the benefits of disinfection but two of the most recent are of particular significance to this proposal. In their "Studies of Diarrhea in Quindio Colombia: Problems Related to Water Treatment" Doctors David Bersch and Margarita Osorio disclosed an inverse relationship between the level of residual chlorine and the rates of diarrhea among children under 5 years of age. In a pilot project in 1981 financed by UNICEF and conducted by the Institute of Child Health in Calcutta India in West Bengal India 300 families received disinfection of drinking water and another 300 families did not. All other factors were determined to be essentially the same. Over a nine month period there was an 80% reduction in the incidence of diarrheal disease among the children receiving the disinfected water and only a 5% reduction in the children which did not receive disinfected water. In situations where water is the predominant vehicle for the transmission of Typhoid, Paratyphoid, Cholera, Campylobacter, Rotovirus, Hepatitis, Dracontiasis or Giardiasis, adequate levels of disinfectant and adequate contact time will result in reduced incidence of disease. The health benefits of more reliable, simpler and lower cost disinfection are patently obvious.

#### CAUSES OF DISINFECTION FAILURE

To resolve the problem of widespread failure of disinfection in Latin America and the Caribbean it is first necessary to identify and understand the nature of the causes behind the failure. Studies and

investigations\* have disclosed a number of commonly cited reasons for failure to disinfect which are;

1. Undependable or unavailable supply of chemicals.
2. Unavailable spare parts.
3. Operational requirements too complex for local operators to carry out.
4. Repair of equipment too complex for local operators to make.
5. Inadequate infrastructure to support the purchase, transport, and storage of chemicals, spare parts and supplies.
6. User dissatisfaction with widely varying chlorine levels .
7. Difficulty involved in local storage, handling, mixing and dosing of chemicals.
8. Insufficient equipment durability.
9. Insufficient operator training and experience as well as inadequate basic education.
10. Inadequate safety considerations.
11. Foreign exchange restrictions.

In almost all specific instances there are multiple underlying causes for the failure to disinfect; some of the causes operate in series and others operate in parallel and they must be resolved accordingly to obtain a lasting solution. A variety of approaches have been taken in the past to solve this dilemma including institutional and human resource development. The results have been less than satisfactory with an increase of only a few percent in the water systems adequately disinfected over the last 20 years. A number of alternative technologies such as ozonation, ultraviolet light, halogenated resins, radiation, iodination, chlorine dioxide, chloramines, and appropriate technologies for hypochlorination have been introduced to overcome the problem but they haven't really circumvented the major causes of the problem. Some have even added to them. Unfortunately the great majority of work and advancements in disinfection technology have been aimed primarily at solving problems encountered in the highly developed and industrialized countries. They have not been directed towards solution of the specific problems and considerably different problems of developing countries.

#### FORMULATION OF THE MOGGOD CONCEPT:

Because no single conventional method of disinfection seemed to overcome a sufficient number of these causes, various combinations of them were explored. The simple combination of methods usually resulted in much more complex operational problems which overshadowed any advantages gained. Another factor to be considered when selecting a suitable disinfectant is the microbiological stability in water distribution systems. A large number of bacteriological strains as well as molds and protozoa are capable of aftergrowth even though the water may have been appropriately treated. The probability of this phenomena occurring is particularly likely where the water contains significant quantities of organic compounds and in areas of warmer water and ground temperatures.\* These microorganisms not only result in decreased organoleptic quality but may also pose a health risk. Since both the warmer temperatures and

organic levels are the predominate conditions in Latin America and the Caribbean it is important that a disinfectant methodology be effective, efficient, broad spectrum and that it also provide an adequate residual.

For all of these reasons PAHO began exploring the feasibility of innovative technology which might avoid or eliminate a sufficient number of the aforementioned problems and causes of failure in order to increase the probability of achieving successful sustained disinfection of small community water systems.

Criteria of desirable characteristics for a disinfection device suitable for small towns and rural areas in Latin America were prepared by PAHO to use in discussions with potential developers and researchers. This included A) simplicity of operation and maintenance and if possible avoidance of the necessity for chemical and mathematical calculations; B) robust and durable equipment which is also easy to repair; C) use of locally or readily available primary chemicals; D) reliable, effective and safe disinfectant which would function over a wide range of typical physical-chemical conditions and which leaves an adequate residual. This criteria first led to consideration of existing devices for on-site generation of sodium hypochlorite, but actual experience had shown these devices to be too complex for the targeted communities.

During the literature research and follow-up with agencies, institutions, scientists and developers it became evident that it was usually simpler and less costly to generate a mixture of disinfecting oxidants than a single pure oxidant. There are several additional potential advantages to the use of a mixture of oxidants.:

1. Different oxidant disinfectants have somewhat different ranges in which they effectively operate. Combining them may increase the possibility of broadening that range.
2. Combination of oxidants can act synergistically as disinfectants.
3. Different oxidants leave residuals of differing half-lives
4. Different oxidants have greater affinity for reaction with various reducing agents and by combining them it may be possible to minimize the undesirable subproducts produced.

It was this realization which induced PAHO to pursue the development of mixed oxidants generated on-site for disinfection (MOGGOD).

#### EFFECTIVENESS OF MIXED OXIDANTS:

Table A depicts the relative oxidation potential of some of the strongest known oxidants. The hydroxyl radical, atomic oxygen, ozone, hydrogen peroxide, the perhydroxyl radical, hypochlorous acid and chlorine are among the oxidants produced by MOGGOD devices. Permanganate is not. Although hydrogen peroxide and the perhydroxyl radical are not effective disinfectants in water they do satisfy the reducing agents in water which would otherwise use up the more effective disinfecting oxidants.



TABLE A  
RELATIVE OXIDATION POTENTIAL OF STRONG OXIDANT SPECIES  
BASED ON REFERENCE OF CHLORINE = 1.00

Oxidant Species	Oxidation Potential (volts)	Relative Oxidation Power *
FLUORINE	2.87	2.25
HYDROXYL RADICAL	2.80	2.05
ATOMIC OXYGEN	2.42	1.78
OZONE	2.07	1.52
HYDROGEN PEROXIDE	1.77	1.30
PERHYDROXYL RADICAL	1.70	1.25
PERMANGANATE	1.68	1.23
HYPOCHLOROUS ACID	1.49	1.10
CHLORINE	1.36	1.00

Duguet, Brodard, Dussert and Mallevalle found that the addition of hydrogen peroxide to water during ozonation increased the rate of ozone transfer and the oxidation of organic compounds. They also found that the addition of hydrogen peroxide in the ozonation process resulted in significant reduction of precursors of trihalomethanes.

Charles P. Hibler, determined that in water with a turbidity of 0.53 to 0.73 NTU containing 10,000 to 40,000 giardia cysts per gallon, the combination of photozone (0.3 to 0.6 mg/l) and chlorine (0.2 to 0.58 mg/l) for a period of 30 minutes of exposure were sufficient to kill or inactivate all of the Giardia cysts while neither photozone nor chlorine alone was able to achieve inactivation. The biochemical mechanisms involved in the inactivation of the cysts is not yet well understood. It has been observed that long duration contact time resulted in destruction of the cyst.

Disinfection with MOGGOD appears to be at least as effective and very probably more effective than with straight chlorine. Additional closely controlled laboratory testing will be required to precisely determine this relation.

#### THE DEVELOPMENT OF MOGGOD DEVICES:

Largely due to the normal course of scientific and commercial development, and in a small part due to PAHO'S encouragement and promotion, several advanced fully functional prototypes of devices for on-site generation of mixed oxidant disinfectants (MOGGOD) have been developed and improved. Two distinct groups of devices which produce mixed oxidants for disinfection have evolved; one relies upon

electrolysis and the other upon photolysis to generate the mixed oxidants. Both show considerable promise of overcoming or circumventing many of the major problems and impediments to disinfection.

The photolysis process utilizes short wave (>185nm) length ultraviolet light to dissociate oxygen molecules into activated species. A schematic of this process is shown in Figure 1. In the PHOTOZONE process ambient air is passed along such a lamp and the generated plasma is diffused into an aqueous solution which is further irradiated by the ultraviolet light further boosting the oxidizing potential as well as contributing to the disinfection. The resultant oxidants in the water stream include ozone, hydroxyl radical, hydrogen dioxide, hydrogen peroxide, and atomic oxygen. This mixture of oxidants has been determined to have a greater oxidizing power than chlorine gas. It has also been shown to be an excellent disinfectant. The PHOTOZONE process uses typically about 7 to 11 kilowatt hours of energy to produce one kilo of the PHOTOZONE gas.

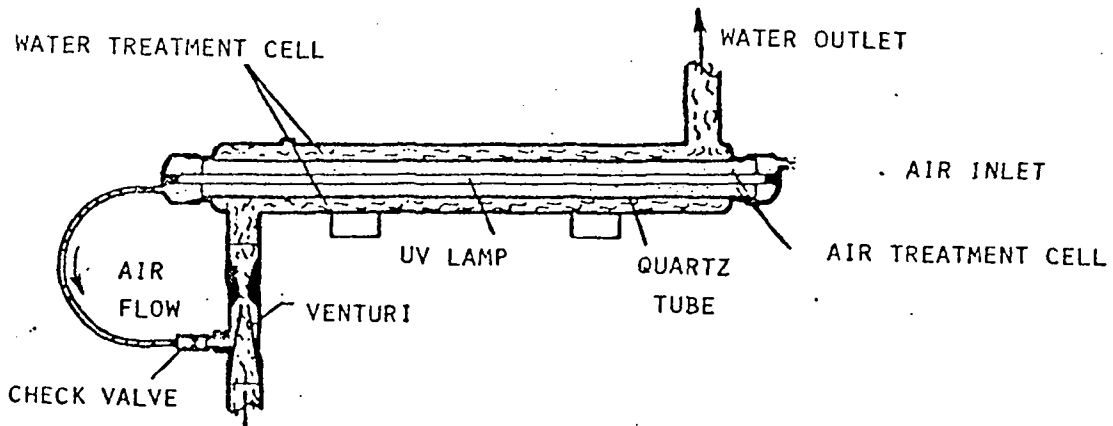


Figure 1. Schematic of the PHOTOZONE principle.

Unfortunately PHOTOZONE does not include a durable residual among its mixed oxidants. Since an effective and durable residual is necessary in Latin American water systems because they are subject to recontamination this device has not yet been installed in the demonstration project but is mentioned here because it is a generator of mixed oxidants.

Electrolysis of a saturated salt solution also is capable of generating mixed oxidants and a large portion of them provide an effective residual disinfectant. The generation of oxidants through electrolysis has been carried out on a commercial scale since the turn of the century and steady advancements and improvements have

been made particularly in the chlor-alkali industry. The introduction of the dimensionally stable anode and the perfluorinated membranes in 1969 and their steady improvement has radically improved the efficiency, lowered the cost of production, and greatly reduced power requirements of the electrolysis processes. Today 90% of the chlorine capacity of North America is produced utilizing these devices and the resultant methodology.

These advancements have made the on-site generation of mixed oxidant gas disinfectants a feasible alternative. The same basic technology, but adapted to insure operational simplicity, durability and compatibility with conditions in remote, small and poor communities has been used to develop the MOGGOD units. To do this some of the efficiency of the electrolysis process has been sacrificed but it is more than compensated for by a gain of overall efficiency which takes into consideration the community capability, storage, transportation, national supporting infrastructure, local conditions and the prevalent human element. A number of prototypes have been produced by different entities and they are considerably beyond the laboratory bench model stage with several units being produced commercially and one particular model having functioned quite well in 10 different actual field installations. The first installation has now been in operation for over 3 years and continues to function exceptionally well, equalling or exceeding the efficiency of conventional methods of chlorination which had previously been used but failed to perform satisfactorily.

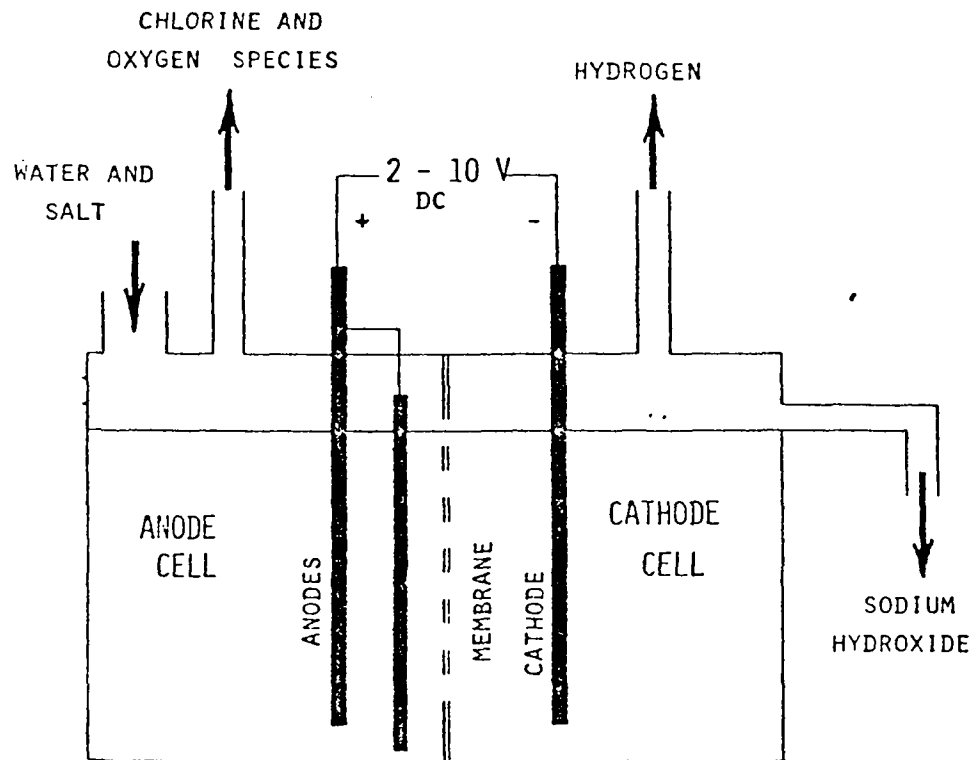


Figure 2. Schematic of MOGGOD electrolytic cell.

Figure 2 is a schematic drawing of the MOGGOD unit indicating the relation of the electrolytic cell components and the input and output of chemicals. The cell is divided into the anode and cathode compartments by a semipermeable membrane ( Nafion ) which is a high performance reinforced composite of perfluorinated cation exchange copolymer. The unit also incorporates a TIR-2000 DSA anode (ELTECH) and a cathode of 440 stainless steel. In addition auxilliary electrodes which are operated at a lower EMF than the primary anode are located between the anode and the membrane. A saturated solution of sodium chloride is maintained in the anode compartment by the addition of water and excess sodium chloride and a 10% solution of sodium hydroxide is maintained in the cathode compartment by the addition of sufficient water and drawoff of excess liquid. Chlorine and activated oxygen species (the mixed oxidant gases) are generated at the anodes while hydrogen gas and sodium hydroxide are formed at the cathode. In the MOGGOD process the mixed oxidant gases are injected into the water to be disinfected, the hydrogen gas is vented to the atmosphere and the excess sodium hydroxide is collected to be utilized for other purposes or to be disposed of.

A somewhat similar cell was described by Michalek and Leitz (\*) in 1972, but no mention was made of oxygen species being generated at the anode. This could have been due to both the absence of an auxilliary electrode and the use of a DSA anode developed specifically for the generation of chlorine rather than one for the generation of oxygen.

Figure 3 is a graph which portrays the useful life of the TIR 2000 anode as a function of current density in amperes per square inch of anode surface in a solution of about 15% sulfuric acid. Increased thickness of the iridium oxide based coating yields an

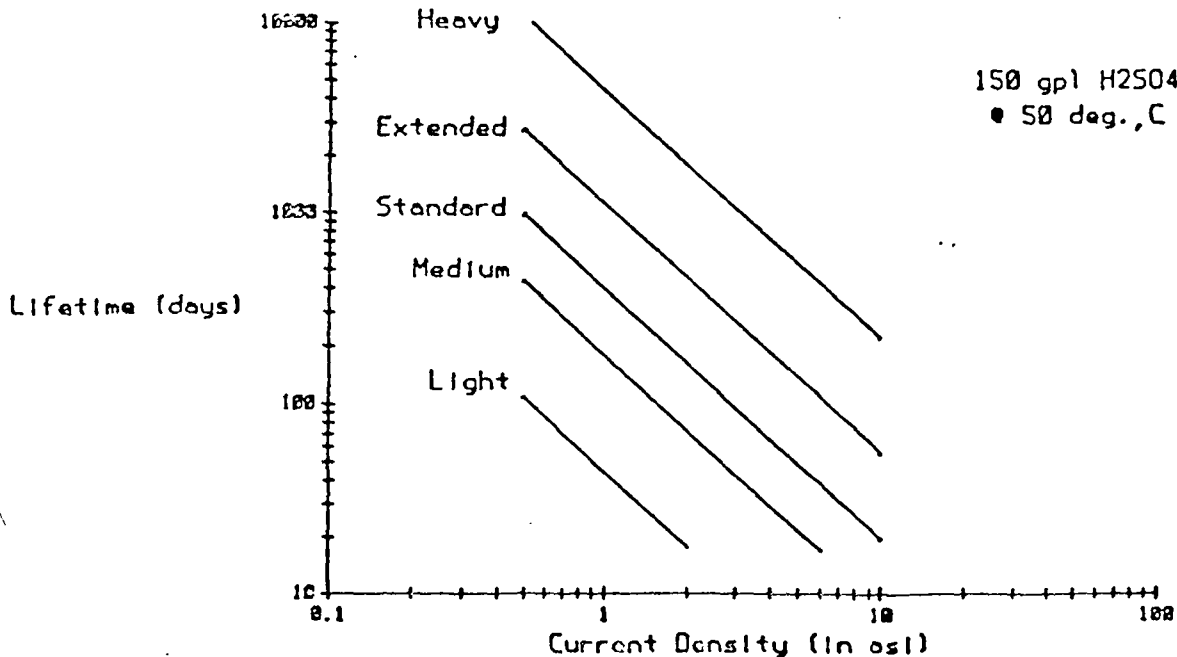


Figure 3. TIR-2000 Lifetime vs. Current Density

increased useful life expectancy for the anode. Since the operational current density of the MOGGOD unit ranges between around 0.6 and 1.0 amps per square inch the life of the anode will range between about 3 and 8 years for the extended life coating and from 7 to 12 years for the heavy coating if the electrodes are in operation 24 hours a day.

Another method which is being developed for the generation of a solution of mixed oxidant disinfectants uses an iridium coated titanium cell with laminar flow. This device which has functioned well in the laboratory has yet to be field tested in Latin America. The disinfectant solution has been tested for effectiveness and equals or exceeds that of chlorine.

#### PAHO'S PROJECT FOR DEVELOPMENT OF MOGGOD TECHNOLOGY:

The initial phase the MOGGOD development project was devoted to promotion, encouragement and fostering the MOGGOD concept and was planned to obtain contributions from government agencies, universities and academic institutions, professional organizations and private industry. This was carried out primarily through personal contact and dissemination and sharing of information. It was also incorporated into PAHO's program for improvement of drinking water quality and the MOGGOD concept was brought forth at PAHO workshops, conferences, seminars and meetings which in any way were related to drinking water, water quality, water treatment, distribution systems. Advancements in all related areas of technology were closely monitored. Sites where installation of MOGGOD type devices had been made by the private sector were visited. Some of the more promising prototypes and second generation MOGGOD devices were purchased and limited testing was carried out by PAHO staff. Many project proposals for MOGGOD development were prepared and submitted to funding agencies.

A total of four MOGGOD devices were purchased by PAHO for use in situations of emergencies brought about by natural disasters for temporary disinfection of water supplies. This was done because shipment of chlorine products by air freight was prohibited and the particular devices utilized salt as the primary material. They functioned well but the length of operation was too short to draw many conclusions about durability, continuity of operation, repairs or maintenance problems.

In July 1986 PAHO awarded a research grant for investigating the effectiveness and efficiency of a MOGGOD device relative to chlorine and in December 1986 advance funds were received from UNDP under the PAHO/UNDP Critical Poverty Program. Matching funds were obtained from country offices and more than forty MOGGOD devices have been purchased and sent to Latin America and the Caribbean for demonstration projects, field testing, laboratory analysis. Countries which have received these devices are Argentina, Bolivia, Brasil, Columbia, Costa Rica, Ecuador, Guatemala, Honduras, Jamaica, Mexico, Peru and St. Lucia. Most of the countries have agreed to collaborate in the demonstration/development project and have

commenced various activities but two of the countries have declined. Collaboration is under consideration in Cuba, Barbados, Chile, Paraguay and Venezuela.

Research has been carried out in Argentina, Mexico, and the USA and more is in the formative stages in Argentina, Brasil, Colombia, Cuba, Guatemala, Ecuador and Peru.

#### PURPOSE OF THE DEVELOPMENT PROJECT:

The overall objective of the development project is to foster and accelerate the development of MOGGOD technology in a manner which will serve the needs of small towns, communities and rural villages of Latin America and the Caribbean.

The specific objectives are to:

1. Test various MOGGOD devices under as wide a range of actual but typical field conditions as possible to determine advantages and disadvantages, strengths and weaknesses and to make recommendations for improvement of the devices.
2. Obtain a better understanding of the technologies involved in the production and utilization of mixed oxidants
3. Disseminate knowledge and information regarding MOGGOD among the institutions and agencies of Latin America.
4. Encourage international collaboration in the development of this technology.
5. Provide data on which to base installation criteria, operation and maintenance instructions, to obtain further refinements and improvements in design and manufacturing.
6. Determine the feasibility of manufacturing the equipment locally.
7. Develop parametric relationships for equivalent mixed oxidant residual and free chlorine residual.
8. Determine the minimum mixed oxidant residual to guarantee pathogen free water.
9. Feed back field performance characteristics to manufacturers to facilitate improvement of equipment performance and reliability and to improve manufacturer support services and reduce costs.
10. Determine and understand the complex chemical reactions of MOGGOD.
11. Develop a data base for installation and operation and maintenance costs.
12. Define commercial quality standards for manufacturing MOGGOD

devices and improve technical specifications.

13. Determine the practical upper limits of MOGGOD device capacity.

14. Determine the effectiveness of MOGGOD against specific waterborne pathogens under varying conditions of turbidity, pH, and temperature.

15. Investigate the potential of MOGGOD for removal of undesirable substances from drinking water such as iron, heavy metals, phenols, cyanides etc.

#### SUMMARY OF ACTIVITIES CARRIED OUT TO DATE:

1. Lecture-demonstrations of MOGGOD Technology were carried out in twelve countries, involving 48 agencies or institutions.
2. A total of 47 units of MOGGOD and assesories were purchased to Argentina, Bolivia, Brasil, Colombia, Ecuador, Guatemala, Honduras, Jamaica, Mexico, Panama, Peru and St. Lucia.
3. Models for easy to understand manuals for: a) installation of MOGGOD, and b) operation and maintenance of MOGGOD were prepared under contract in both Spanish and English.
4. Technical information on MOGGOD was provided to all of the pertinent agencies of the countries participating in the PAHO/UNDP Program and to an additional seven countries and their appropriate agencies.
5. Draft proposals for national MOGGOD demonstration projects were prepared and provided to Argentina, Colombia, Mexico, and Peru for submittal to the national offices of UNDP for funding.
6. Draft terms of reference for participation in a regional MOGGOD demonstration project were developed and provided to eight countries.
7. Three MOGGOD research projects were implemented and five additional research proposals and protocols and are in the stage of soliciting funds.
8. As a direct result of this project, manufacturing of MOGGOD devices has been initiated by private industry (FENAR) in Argentina and is being explored in Mexico by CEDAT. CEDAT has developed a number of prototypes, which are being field tested. It is under consideration in Colombia
9. MOGGOD devices have been installed in seven of the participant countries and field testing is underway .
10. Field visits were made to a total of 20 potential field demonstration sites and instructions for site preparation and

MOGGOD installations were provided.

11. An international seminar on disinfection of small community water supplies with MOGGOD was held almost exactly one year after the demonstration - development project was initiated..

#### FINDINGS TO DATE:

There are several potential economic benefits of improved disinfection through MOGGOD. There is both the direct cost reduction of the disinfectant itself and that which is due to simplified operation and maintenance requirements of the apparatus. Another economic benefit would affect those countries which import chlorine and chlorine products by reduction in foreign exchange of currency. Finally, there is the intuitively obvious but less definitive economic benefit of a healthier people.

Although more time is needed to sufficiently stress the components of the MOGGOD devices it presently appears that the cost of MOGGOD disinfectant ranges from US\$ 0.25 to 0.60 per kilo produced.

There are a number of advantages of MOGGOD which should help avoid a number of the problems encountered in sustaining conventional chlorination, particularly in small and remote towns and communities. They are:

The only make up chemicals are salt (sodium chloride) and water. Sodium chloride is available almost everywhere for other uses. This chemical is easily transported, stored, handled with minimal hazard to the environment and none to the worker. It is also one of the least expensive chemicals available.

Power requirements are extremely low. The voltage requirement is between 5 and 10 volts at the electrodes and the current drawn is about 12 amps per kilogram of disinfectant generated over a 24 hour period. If conventional electricity is not available it is feasible to utilize photovoltaics or mini-generators on the water transmission line for a power source.

Operational requirements are visually oriented. Mathematical and chemical skills are not essential for the correct operation. It can be visually determined when it is necessary to add sodium chloride. The operator merely looks to see if the salt crystals or the water level are getting low and adds some more if necessary. The amount of disinfectant applied is determined by the adjustment of a dial (rheostat) to obtain a predetermined current indicated by a needle. All of this simplifies operation for the typical poorly educated operator.

The oxygen species of the mixed gas disinfectant are the dominant species and tend to react with organics and other substances before the chlorine species. This results in the chlorine species acting primarily as a residual. This generally results in improved taste and odor of the water and enhances user



support for continuous and reliable disinfection.

The electrode to electrode power consumption in the MOGGOD units to date fall in the range of 4 kilowatt hours per kilogram of oxidant produced.

The MOGGOD device produces only the amount of oxidant needed instantaneously thereby decreasing the problems of storing large quantities of highly reactive substances.

To date it has been determined that MOGGOD disinfection is at least equivalent to disinfection with chlorine in both the laboratory and actual field installations. Additional experiments are necessary to check the effectiveness against various pathogens.

The weakest component of the MOGGOD devices is the membranes. Care must be taken to not puncture them. Even though training has been given and warnings of the fragility of the membrane, it has been punctured when the operator tries to clean off deposits with something other than water, such as a brush or screwdriver. Some of the techniques and methods used for installing and replacing membranes do not lend themselves well to easy repairs.

The use of impure salt (sodium chloride) has caused more problems than any other factor through clogging of the membrane. Apparently there is a great temptation to use impure salt and the unit will function for quite some time using impure salt but the decrease in useful membrane life is directly proportional to the increase in impurities. It is possible to clean the membrane with an acid solution but the inconvenience and labor costs are higher than the difference in cost between pure and unpure salt.

Even though instructions have been given and installation drawing provided a number of installations have been poorly designed and constructed. A technical expert should be present for the first installations in a country or region of a country. A concerted collaborative effort should be made to develop a good selection of standard drawings for typical installation conditions in Latin America and the Caribbean.

MOGGOD devices do not constitute a panacea but a good alternative for disinfection in small community systems.

Even though the operation and maintenance of the MOGGOD devices are extremely simple, training is nonetheless required for new users of this technology. They require attention at least once a week and preferably twice a week.

## EXTENDED ABSTRACT

### COMPARATIVE BACTERICIDAL AND VIRICIDAL ACTIVITY OF ON-SITE GENERATED OXIDANTS USED FOR THE DISINFECTION OF WATER

PAN AMERICAN HEALTH ORGANIZATION WORKSHOP  
LIMA, PERU  
DECEMBER 7-11, 1987

VINCENT P. OLIVIERI  
DEPARTMENT OF GEOGRAPHY AND ENVIRONMENTAL ENGINEERING  
THE JOHNS HOPKINS UNIVERSITY  
BALTIMORE, MARYLAND

A small pilot scale study was conducted in the laboratory to determine the efficacy of the mixed oxidants generated from a small electrolytic cell. The specific objectives were:

1. to compare the bactericidal and viricidal activity of the mixed oxidants generated by the on-site generated disinfectant device to that of an equivalent concentration of free chlorine.
2. to determine the presence or absence of short-lived biocidal species in the mixed oxidants produced by the on-site generated disinfectant device.

#### EXPERIMENTAL PROTOCOL

##### Comparative Disinfection

The disinfection trials were conducted in three plug flow reactors, run in parallel. Baltimore City tap water was dechlorinated by filtering through granular activated carbon column and was used for this series of experiments. The dechlorinated tap water was not tempered or buffered. The temperature over the course of the experiments was 18-23 C and the pH ranged from 7.0 to 9.0. A microbial test mixture containing washed and purified suspensions of *E. coli*, *P. aeruginosa*, and or *B. subtilis*, and F2 virus at level of  $10^7$  to  $10^8$  of each of the test microorganisms/ml was aspirated into dechlorinated, untempered and unbuffered Baltimore city tap water and allowed to mix through a short coil of 1/2 inch tubing prior to the addition of disinfectant. The total flow for the three parallel reactor system was slightly more than 2 gal/min. The microbial mixture was metered in such that the microbial test mixture was diluted about 1000 fold. The final microbial density at time zero was about 10000/ml for each microorganism. Control samples were collected for determination of chlorine residual and

microbial density after the granular activated carbon over the course of the experimental trial. The flow containing the test microbial mixture was split in three continuous plug flow reactors. The reactor conditions are listed in table 1. Reactor A, B, and C contained the following disinfectants, the gas form the on-site oxidant generator, the solution prepared from the gas from the oxidant generator and a chlorine solution prepared from chlorine gas, respectively. The presence of short-lived oxidants produced was evaluated by preparing a solution from the oxidant gas about 1 hour prior to the beginning of the disinfection trial and allowing the gas to prereact to dissipate any short-lived intermediates.

Table 1. Reactor conditions for the three parallel plug flow reactors.

REACTOR	FLOW GAL/MIN	DISINFECTANT	INITIAL MICROBIAL DENSITY #/ML	pH	TEMP C
A	1.0	oxi gas	10000	7.0-9.0	18-23 C
B	0.5	oxi solution	10000	6.8-9.0	18-23 C
C	0.5	chlorine	10000	6.8-9.0	18-23 C

Reactors A, B and C received the same test water at the same microbial, chemical and physical conditions. The oxidant gas or solution was aspirated into each reactor and the oxidant flow was monitored by a rotameter and controlled with a metering valve. The disinfectant flow was adjusted such that the total residual oxidant was the same at the first sample port immediately following the disinfectant aspirator and mixing loop. The test system was allowed to equilibrate and was monitored residual disinfectant for 1 sample course prior to beginning each experimental trial.

#### Sampling protocol

Each reactor had provisions for 4 sampling ports after the addition of disinfectant. The contact time for each port and each reactor was determined with fluorescein dye tracer added at the disinfectant aspirator under the conditions of flow used for the experimental trials. The contact times for the sample ports in each reactor are given in table 2.

Table 2. Contact time determined by fluorescein dye tracer studies. Fluorescein was added at the disinfectant aspirator and continuously monitored at each sample port. The flow rates for reactors A, B, and C were 1.0, 0.5 and 0.5, gal/min, respectively. Each number represents the average of AT LEAST 6 trials for each port.

REACTOR	TIME, SECONDS		
	A	B	C
PORT 1	21	21	17
PORT 2	40	77	76
PORT 3	58	115	123
PORT 4	80	150	148

After equilibration and monitoring, the three plug flow reactors were run simultaneously with three sample cycles for each trial. Samples collected for chemical and biological analysis. Each sample cycle consisted of an initial 200 ml sample to rinse the port and collection beaker, a 200 ml sample for chemical analysis and an approximate 75 ml sample for microbiological analysis. The chemical samples from the first and third cycles were immediately assayed for free oxidant and total oxidant by amperometric titration while the second cycle chemical sample was used for the determination of pH. The grab biological samples were collected and combined in a 250 ml sterile polyethylene bottle containing 0.2 ml of a 1% thiosulfate solution to stop the action of the oxidants. Chemical and biological samples were also collected after the carbon filter and before disinfectant addition (This was the zero time sample, No.) for each cycle. Total oxidant in the latter samples was determined by the DPE method and was always negative after the carbon column. The biological assays were conducted as soon as possible after each trial.

#### METHODS

##### Chemical

##### Preparation and Assay of Disinfectants

Chlorine solutions will be prepared by bubbling chlorine gas through triple distilled water. Chlorine concentrations were determined spectrophotometrically, colorimetrically and amperometrically according to the methods and procedures

described in Standard Methods for the Analysis of Water and Wastewater (APHA, 1985).

The oxidant gas was generated in an electrolytic cell supplied and manufactured by Oxidizers Inc. located in Virginia Beach, Va., USA. The oxidant gas generator was set up and operated according to the instructions supplied by the manufacturer with minor modifications. Total oxidant will be measured by the amperometric and colorimetric methods used for chlorine given in Standard Methods (APHA 1985).

#### MICROBIOLOGICAL

##### Preparation and Assay of Bacteria

Escherichia coli strain B was grown overnight under aerated conditions at 37 C on tryptone yeast extract (TYE) broth. The bacteria was washed three times in phosphate buffered saline and added to the water to be disinfected at a density of 10,000 colony forming units/ml (cfu/ml). Survival of E. coli was determined by spread plates on Macconkey's agar. Red colonies were counted after incubation at 37 C for 48 hours.

Pseudomonas aeruginosa was grown overnight under aerated conditions at 37 C on tryptone yeast extract (TYE) broth. The bacteria was washed three times in phosphate buffered saline and added to the water to be disinfected at a density of 10,000 cfu/ml. Survival of P. aeruginosa was determined by spread plates on Macconkey's agar. Colorless colonies were counted after incubation at 37 C for 48 hours.

Bacillus subtilis spores were prepared were added to the water to be disinfected at a level of about 10000 cfu/ml. Survival of B. subtilis spores was determined by spread plates on trypticase soy agar after treatment of samples at 80 C for 10 minutes. Orange colonies were enumerated after 48-72 hours incubation at room temperature.

##### Preparation and Assay of F2 Bacterial Virus

The bacterial virus was grown and purified and added to the test system at about 10000 plaque forming units /ml, pfu/ml. The survival of F2 will be determined by the agar overlay technique on tryptone, yeast extract agar using E. coli K13 as host. Plaques were counted after 18-24 hours incubation at 35 C.

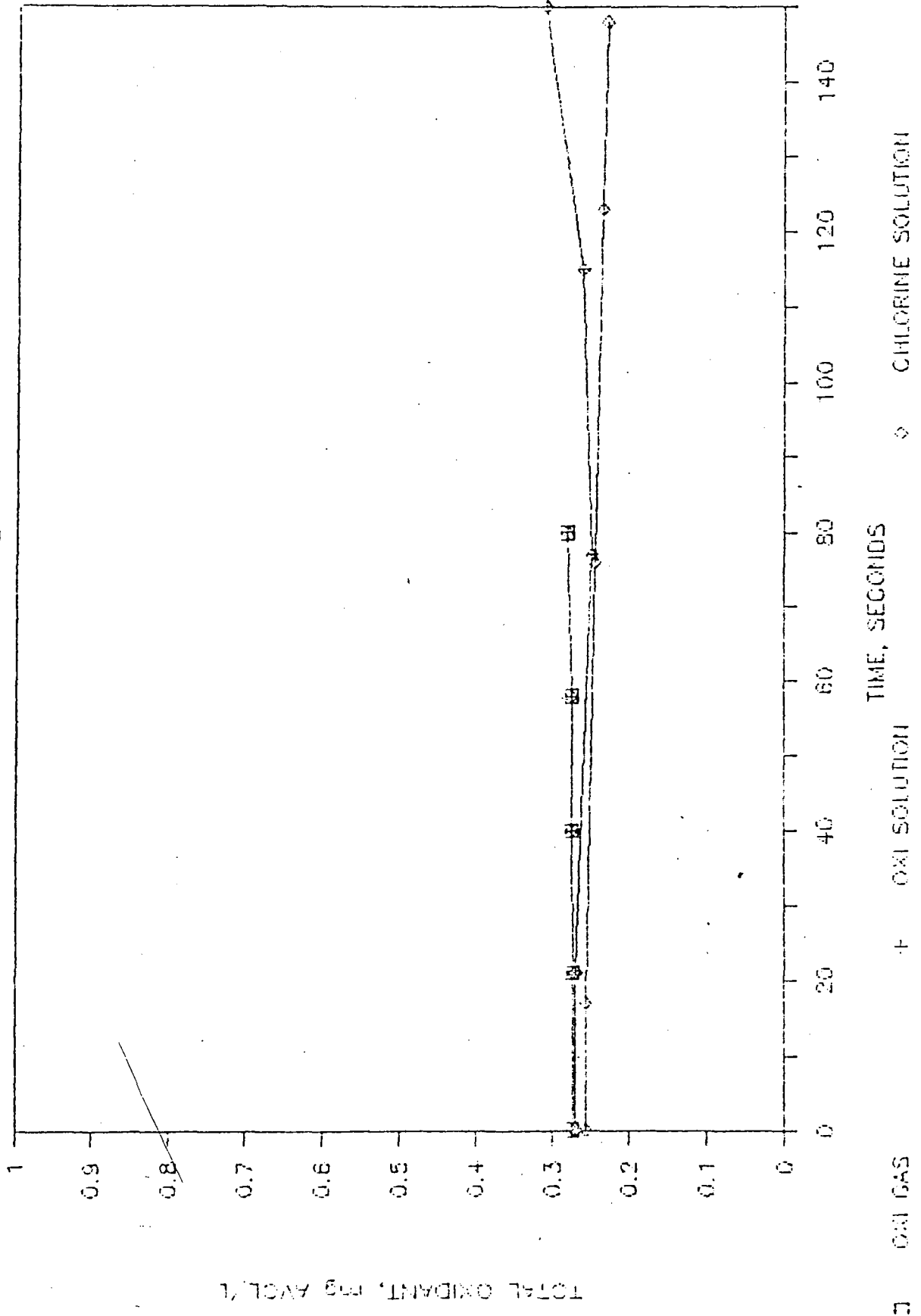
#### RESULTS

The total oxidant residual reported as available chlorine is shown in figure 1 for the three parallel plug flow reactors for oxi gas, oxi solution and chlorine for the time course of the disinfection. The data is for experiments conducted at a setting of 5.0 -6.2 amps for the oxi generator and represents the average of 3-5 trials. The total residual oxidant was similar for the three disinfectants.

Figure 2 shows the survival of E. coli through the test system without any oxidant. The levels of E. coli are reported as the survival fraction, N/No and remained constant over the time course of the experimental trials. Little difference was

FIGURE 1. TOTAL OXIDANT RESIDUAL

8.0-8.2 AMPS



TOTAL OXIDANT, MG AVCL/L

TIME, SECONDS

CHLORINE SOLUTION

OXI SOLUTION

OXI GAS

FIGURE 2. SURVIVAL OF F2 VIRUS

RUN 12, CONTROL - NO OXIDANT

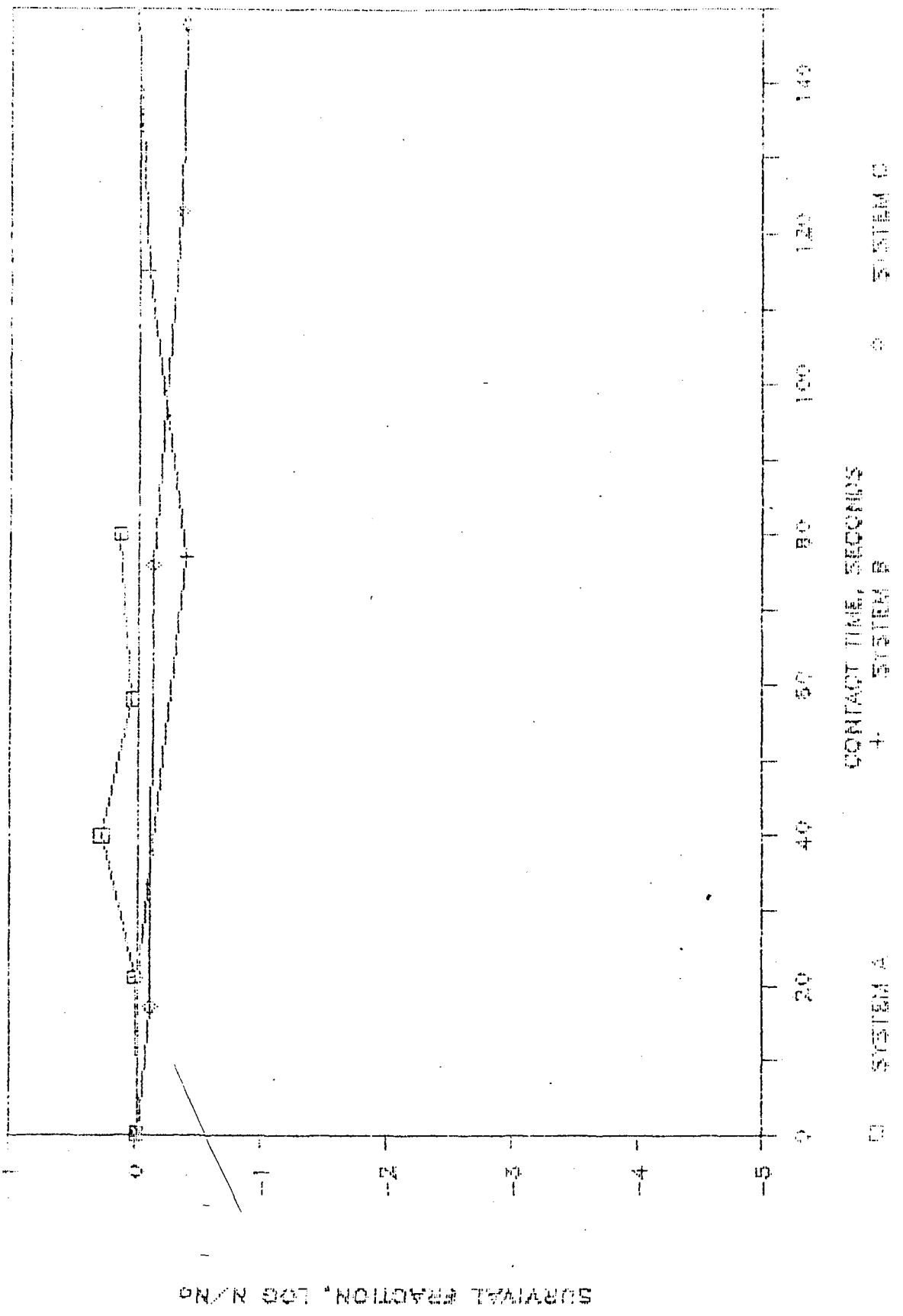
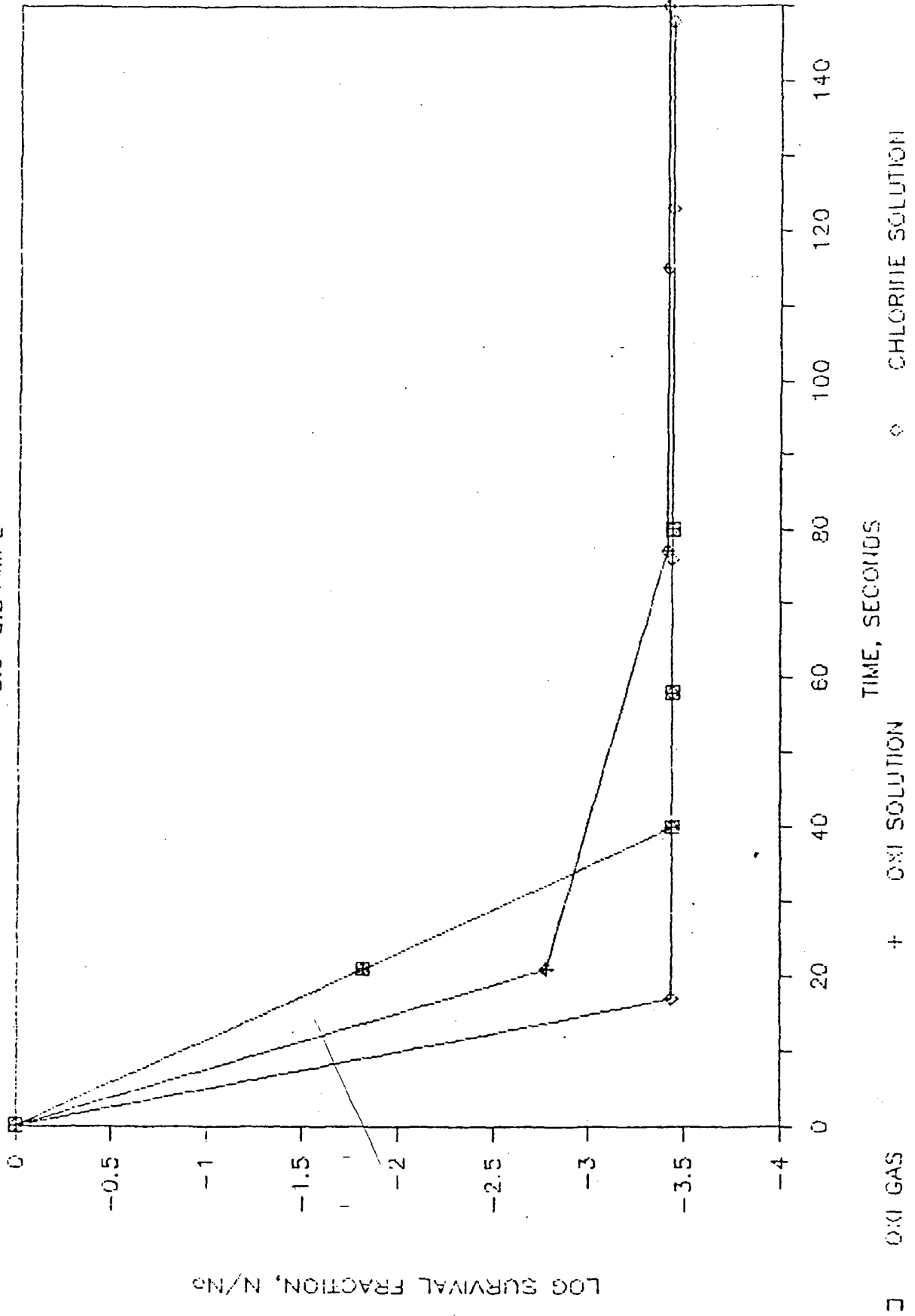


FIGURE 3a E. coli SURVIVAL  
8.0-8.2 AMPS



□ OXI GAS  
+ OXI SOLUTION  
◇ CHLORINE SOLUTION



FIGURE 3b. *P. aeruginosa* SURVIVAL

8.0-8.2 AMPS

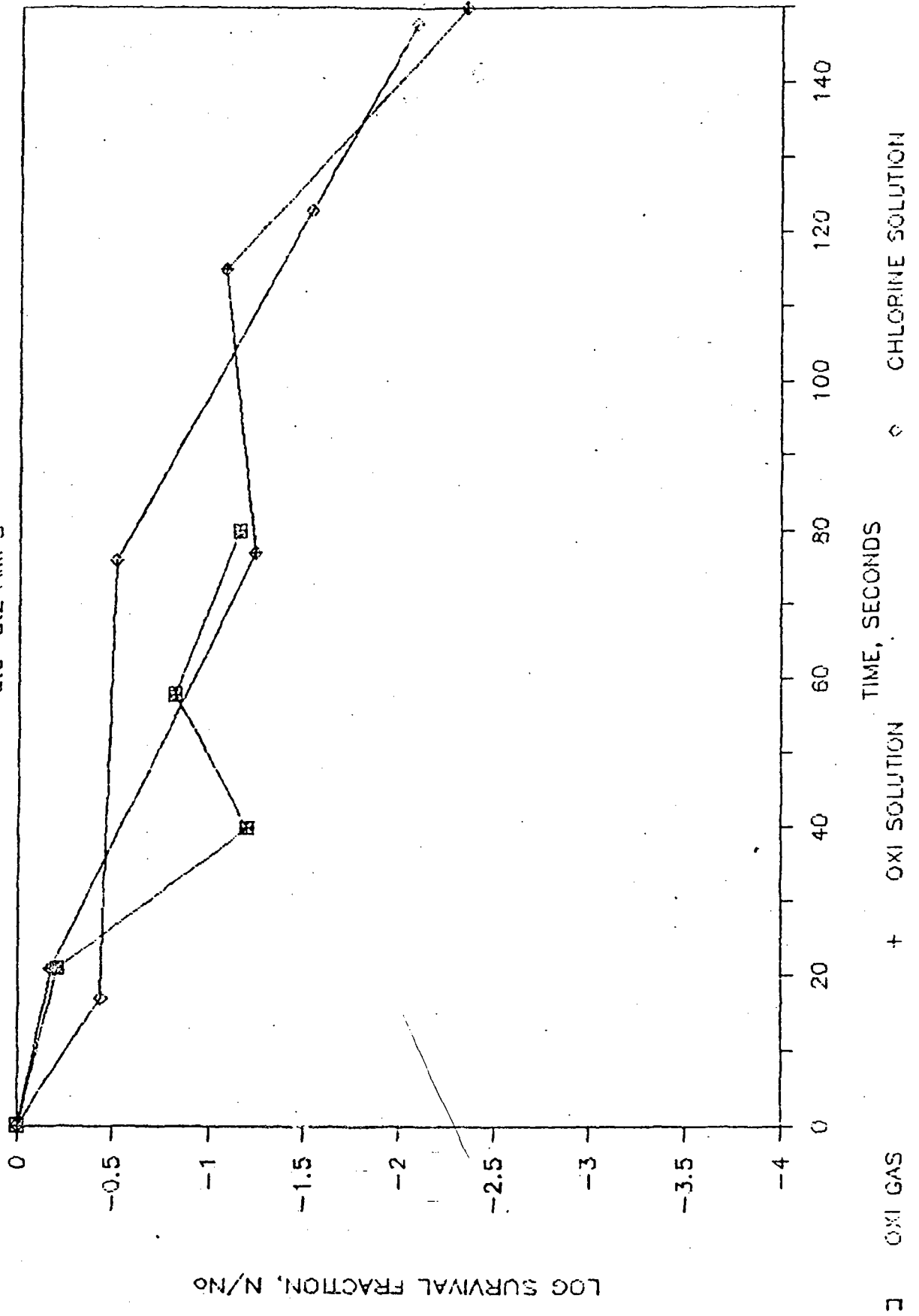
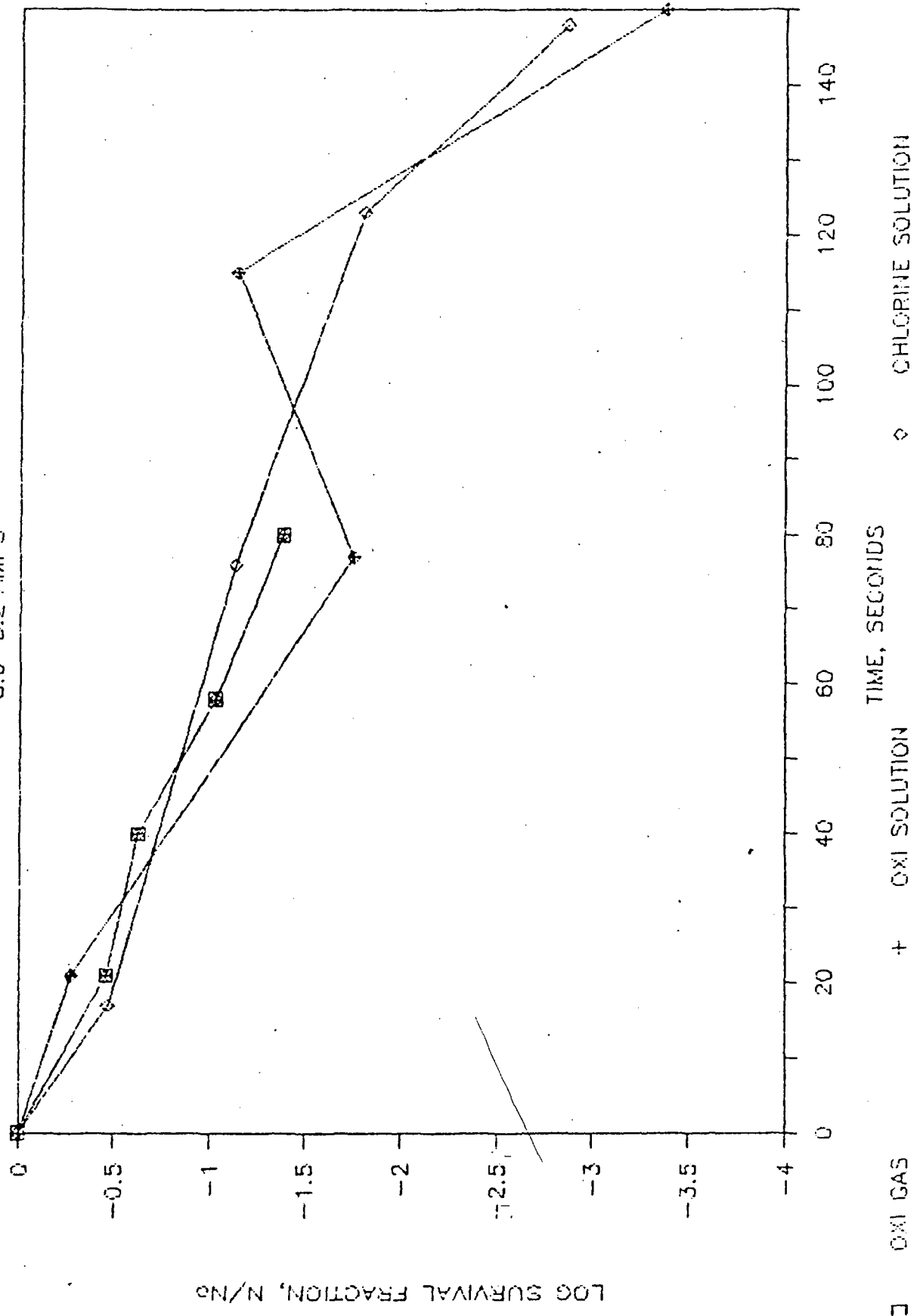


FIGURE 3c F2 VIRUS SURVIVAL

8.0-8.2 AMPS



□ OXI GAS

+ OXI SOLUTION

◇ CHLORINE SOLUTION

TIME, SECONDS

LOG SURVIVAL FRACTION, N/No

observed for the three different reactors. Similar results were obtained for *P. aeruginosa*, *B. subtilis* and f2 virus.

The comparative disinfection of *E. coli*, *P. aeruginosa*, and f2 virus is shown in figures 3a, 3b, and 3c, respectively. The survival of each microorganism is reported as the log of the survival fraction over the time course of disinfection. Each of the test microorganisms was rapidly inactivated with each of the test disinfectants. Little difference was observed for the microbial survival for the oxi gas, the oxi solution or the chlorine solution.

Figure 4 shows the total oxidant residual for comparative trials where the current to the oxi gas generator was varied from 2-8 amps. The total oxidant was about 0.5 mg/l for the 2 and the 4 amp trial, while the total oxidant was about 2.5 for the 6 and 8 amp trials. The oxidant residual was constant over the time course of disinfection. The comparative microbial inactivation is shown in figure 5a thru 5c. When the difference in oxidant residual is taken into account, little difference in the disinfectant efficacy for the oxi gas was found.

#### SUMMARY

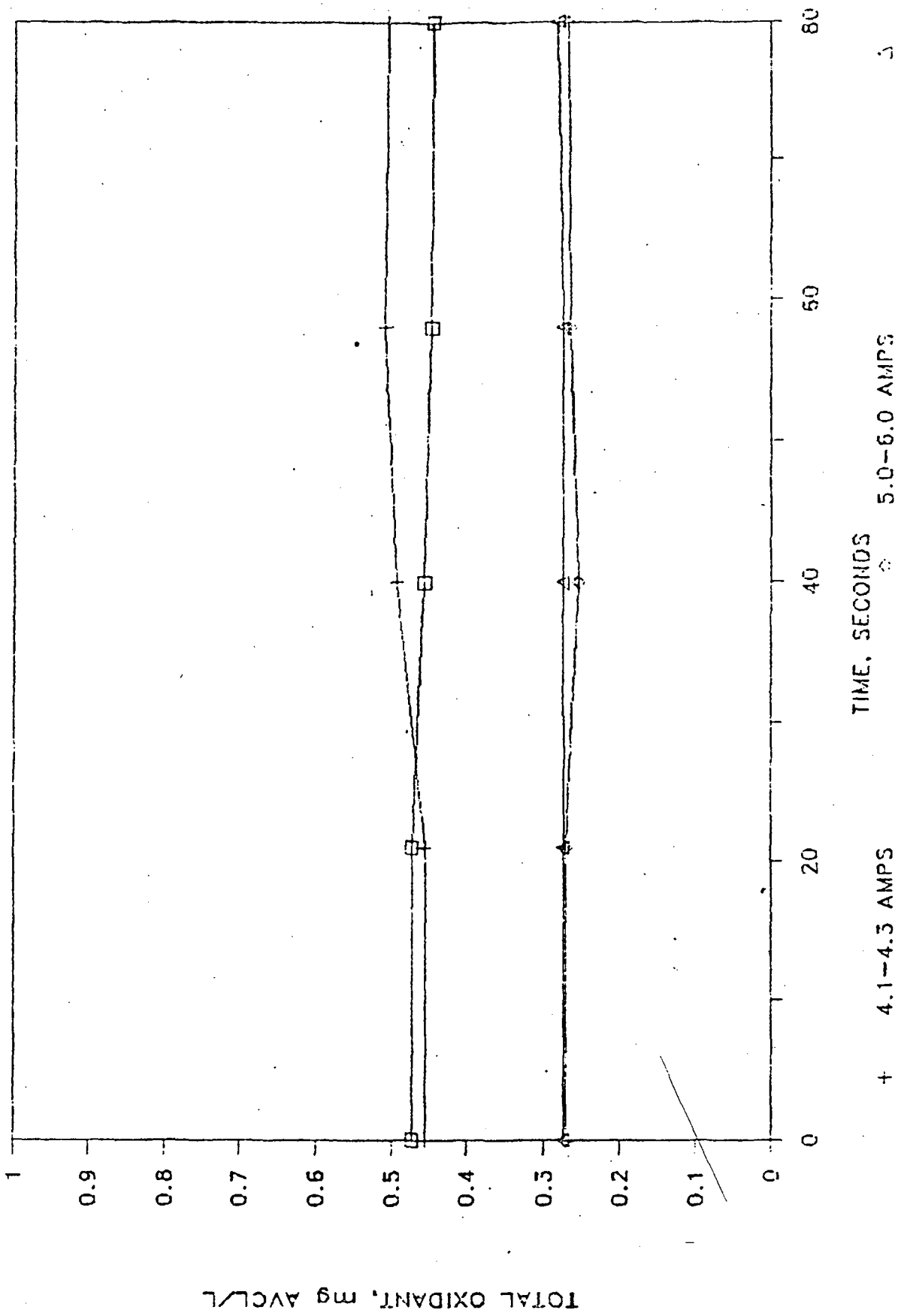
The gas produced by the on-site disinfectant generator rapidly inactivates *E. coli*, *P. aeruginosa*, and f2 virus in water. The disinfectant activity the gas appears to be equivalent chlorine solutions at an equal total oxidant residual under the same chemical and physical conditions. No evidence for the presence of biocidal short-lived products was observed.

#### ACKNOWLEDGEMENT

This study was supported by the Pan American Health Organization. The on-sit oxidant generator was supplied by Oxidizers Inc. located in Virginia Beach, Va., USA. The author gratefully acknowledges the assistance of Maria Yolanda Ramirez and Silvio Arango-Jaramillo and the technical assistance of Ed Rhode, Paula Larson, Lynne Cox and Glorestine Toles.

# FIGURE 4 TOTAL OXIDANT RESIDUAL

OXI GAS 2, 4, 5 & 8 AMPS



11

FIGURE 5a E. coli SURVIVAL

OXI GAS, 2, 4, 6 & 8 AMPS

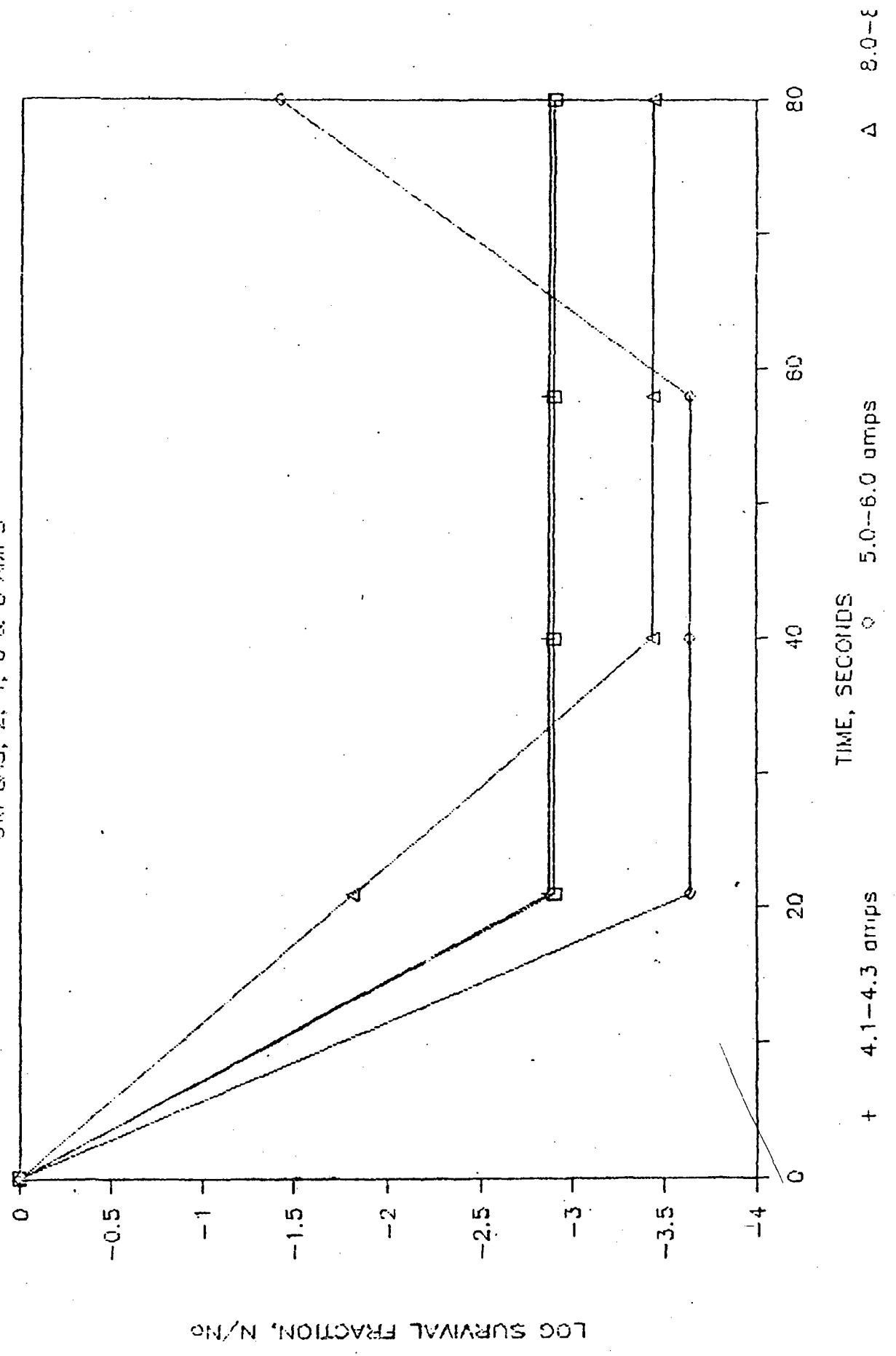


FIGURE 56 P. aeruginosa SURVIVAL  
OXI GAS, 2, 4, 6 & 8 AMPS

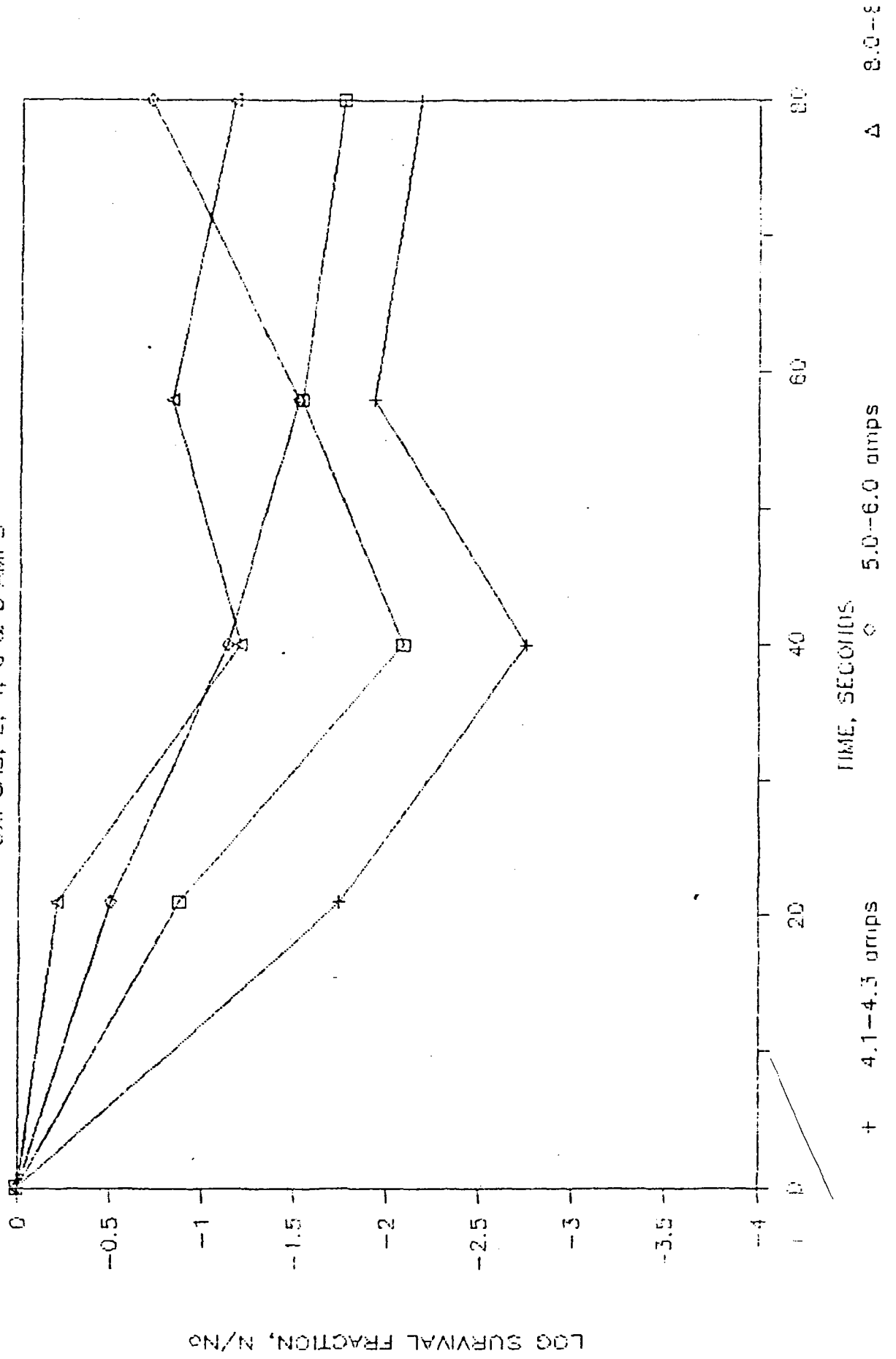
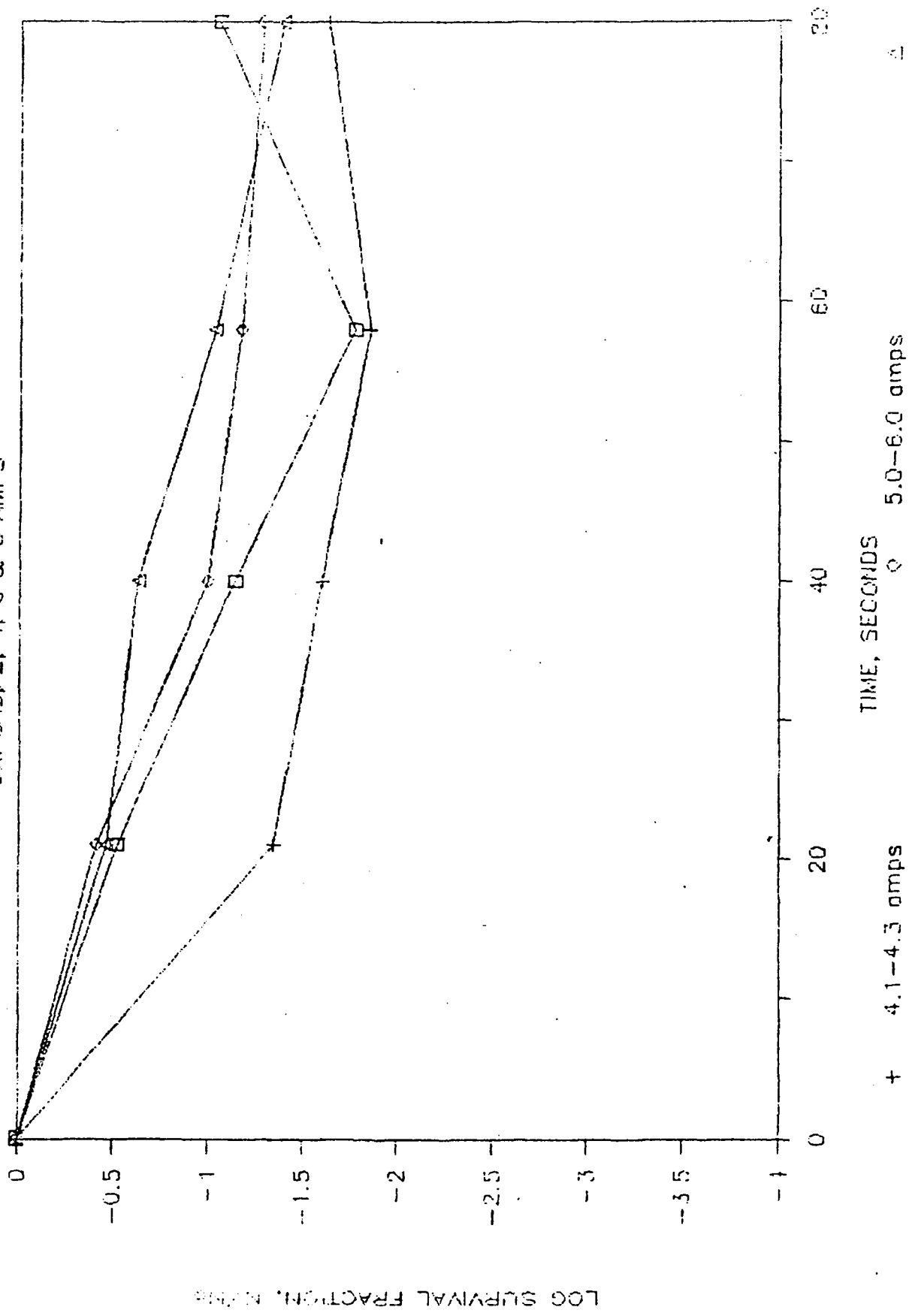


FIGURE 5C F2 SURVIVAL

OXI GAS, 2, 4, 6 & 8 AMPS



## WATER DISINFECTION WITH A MIXED-OXIDANT SOLUTION

Ann M. Pendergrass, Helen F. Gram, Deborah K. Steele, and Marke W. Talley  
Los Alamos Technical Associates, Inc.  
Los Alamos, NM

### Abstract

An innovative water treatment system produces a solution of mixed oxidants, including free chlorine, hydrogen peroxide, hypochlorite, ozone, and free radicals from dilute brine. The small, rugged, portable unit operates unattended and at a low power requirement. Each volume of the mixed-oxidant solution, which is fed directly into water to be disinfected, can treat up to 1,000 volumes of contaminated water. The treatment method has proved effective against several human pathogens, including cysts and spores. Treated water meets all U.S. drinking water standards and recommendations.

#### 1. Introduction

Safe drinking water is a goal but not a reality in many parts of the world—developed as well as developing countries. One answer to this need is a small, portable water treatment unit that can be safely operated at low cost by people who are not highly technically trained and that can serve a range of community sizes.

Los Alamos Technical Associates, Inc. (LATA), located in New Mexico, has developed a simple, low-voltage electrolytic method of sterilizing potable water that can be used in remote locations, developing countries, and natural disaster areas. The method requires only electrical power and salt or seawater and produces a mixture of oxidants directly in solution. One volume of the oxidant stream mixed with 500 to 1,000 volumes of contaminated water will quickly kill common microorganisms, including human pathogens such as Giardia, Legionella, and Pseudomonas that are resistant to chlorine. The treated water meets U.S. drinking water standards and is safe for human consumption. Power requirements are 12 V dc to 24 V dc, 14 A for a unit capable of producing up to 30,000 l (8,000 gal) of potable water per hour of operation or 700,000 l (180,000 gal) of potable water in a 24-hr day. The unit operates unattended and can be maintained by semi-skilled persons. In addition, no hazardous products are required or produced.

The water treatment system developed by LATA is small in size, rugged, and portable. The pilot unit shown is about the size of a television set. The only moving part



of the system is a small pump that moves salt solution through the system. The mixed-oxidant solution, which is electrolytically produced, contains free chlorine, hydrogen peroxide, hypochlorite, free radicals, and ozone. This solution mixes directly and easily with the water to be disinfected, offering some advantages over gas-phase systems, which will be discussed later. A U.S. patent application is pending.

## 2. General Description of the Electrolytic Water Treatment System

The water treatment system is designed to be very flexible and simple in both construction and operation. Required parts are

- a salt solution supply, such as 550  $\times$  (150 gal) tanks;
- a power source, which can be 220 V ac or 110 V ac;
- a transformer to produce 12 V dc to 24 V dc, 14 A current;
- an electrolytic cell to produce the oxidant solution, 10 cm (4 in. x 6 in.);
- two rotometers to adjust the flow rates of the oxidant and discarded streams;
- a vacuum breaker seal pot to keep the flow rate of the oxidant solution constant when the supply line is connected to a jet eductor;
- an oxidant outflow line; and
- a discard outflow line.

The unit is contained in an all-weather fiberglass case. Because salt water is corrosive, all wetted parts are stainless steel or polyvinyl chloride.

A diagram of the water treatment system shows its schematic design (Figure 1). External connections supply electrical power and dilute salt solution to the unit. Both power and salt can be supplied in several ways, making the unit highly adaptable to local conditions. The power supply can be 220 V ac or 110 V ac. According to a study made by one of LATA's engineers, power could also be supplied from solar panels. With some modifications, a 12 V diesel generator could also be used.

The dilute salt solution can be provided by seawater or by crystalline NaCl added to water drawn from the supply line before treatment, as shown in the schematic. Preparation of the dilute salt solution can be simplified for nontechnically trained personnel (Figure 2). A saturated solution of salt is prepared; then a known volume of the saturated solution is diluted to a predetermined volume in the feed tank. The

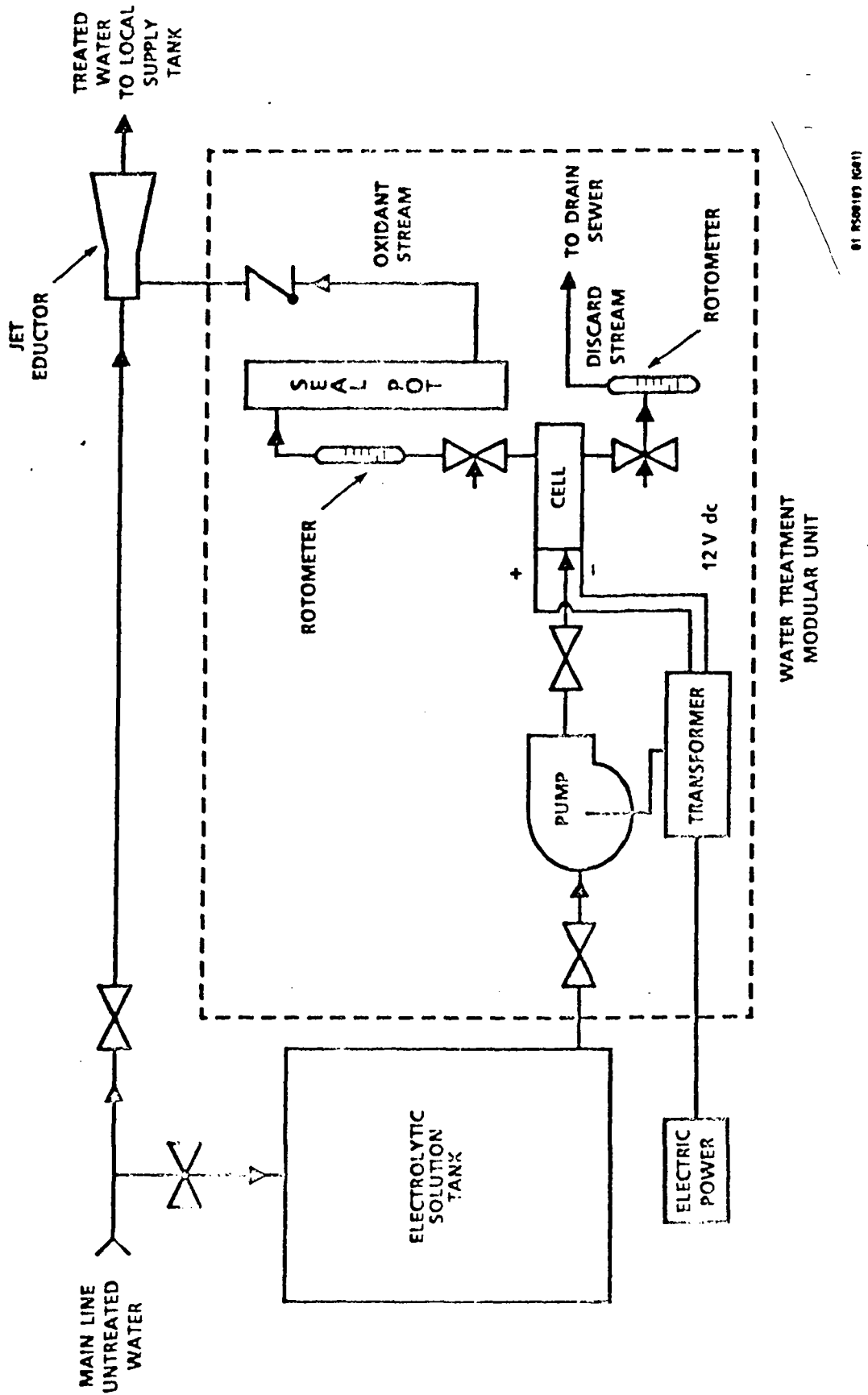
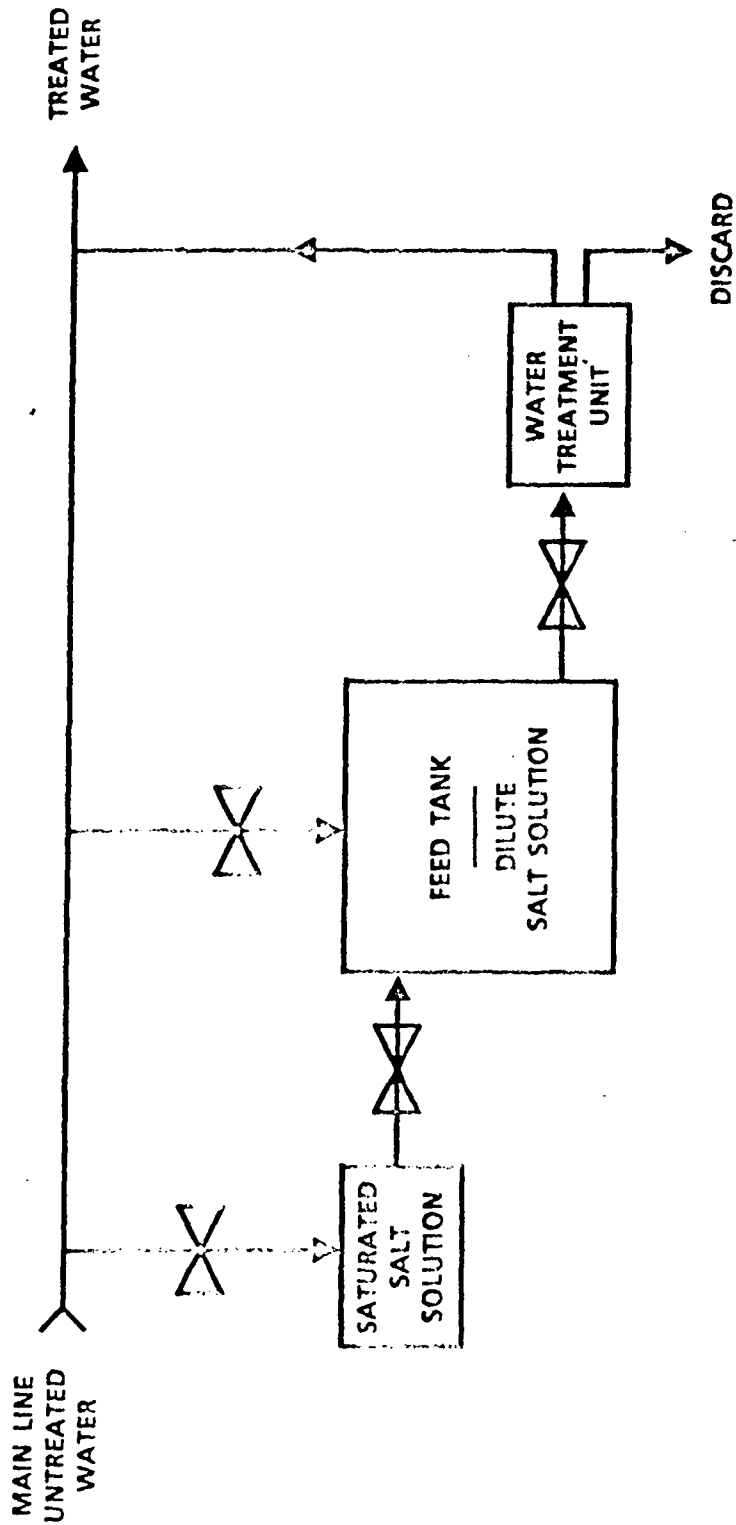


Figure 1. Schematic Design of LATA's Water Treatment Unit



02-RS00183 (G01)

Figure 2. Dilute Salt Solution Prepared from a Saturated Solution

saturated concentration of NaCl is not very sensitive to temperature; there is only about a 10% increase (35.7 g to 39.1g/100 ml) between 0°C and 100°C. This variation in salinity can be compensated for by a transformer that supplies a constant current.

From the supply tank, salt solution is pumped through the electrolytic cell. Oxidants produced in the cell emerge in the anolyte stream, and the catholyte stream is discarded. The rotometers control the rate of flow through the system. A jet eductor, which has no moving parts, operates on the pressure drop caused by flowing liquid—that is, the oxidant solution is aspirated into the water stream (i.e., venturi effect). The partial vacuum on the feedline of the jet eductor introduces the oxidant solution into the water to be treated.

### 3. Operating Parameters of the Water Treatment System

#### Sizing Flexibility

The water treatment system is designed to be flexible to meet the requirements of the specific location. The oxidant production unit is modular; two or more could be installed in a series if the demand for treated water exceeds the capacity of a single unit and to provide backup capability if a unit should require maintenance or fail. Alternatively, a unit could be operated for only part of a day. The flow can thus be matched to local demands.

#### Production Capacity

One modular unit with the cell operating at 14 A uses dilute brine at the rate of 60 l/hr (16 gal/hr) as feedstock. The brine is 0.75 M NaCl, which is equivalent to seawater. The unit produces 30 l/hr (8 gal/hr) of mixed-oxidant solution and the same volume of discard (Table 1). Based on effectiveness tests, this volume of oxidant solution can treat 30,000 l/hr (8,000 gal/hr) of potable water.

#### Maintenance

Continuous, unattended operation has been demonstrated with the pilot water treatment system. A unit can be sized so that it is only necessary to replenish the brine

TABLE 1

## WATER TREATMENT SYSTEM OPERATING PARAMETERS

Power Use	
Cell	12 V to 24 V, 14 A
Pump	110 V, 1 A
Salt Use	1.8 kg/hr (4 lb/hr) 43 kg/24 hr (95 lb/24 hr)
Brine Flow Rate	60 $\ell$ /hr (16 gal/hr)
Oxidant Production	30 $\ell$ /hr (8 gal/hr)
Discard Stream	30 $\ell$ /hr (8 gal/hr)
Water Treatment Rate at 1: 1000 oxidant solution to contaminated water	30,000 $\ell$ /hr (8,000 gal/hr) 700,000 $\ell$ /24 hr (180,000 gal/24 hr)

supply once each day. Operators need not be highly trained. Their requirements are to fill the brine tanks, turn the unit on, verify flow rates and ampere reading, and test for chlorine in the treated water by using a standard color test kit.

#### Power Sources

The pilot water treatment unit was developed for a 220 V, 50 Hz power supply. A constant current transformer supplies 110 V to the pump and variable voltage at 14 A to the cell. The unit can readily be adapted to other power sources. The voltage supplied to the cell to create a 14 A current flow may depend on parameters of the local water used to prepare the brine feedstock.

#### Salt Supply

The water treatment system has been developed for dilute brine feedstock such as seawater or 0.75 M (30 g/l or 0.25 lb/gal) of NaCl solution. Alternatively, a saturated-bed feedstock can be diluted to achieve this same concentration. Both dry NaCl and seawater are widely available.

Cost of Operation

The economics of operation depend upon local costs for salt and electrical power. The support equipment requirements are modest, including tanks for brine feedstock, assorted piping, a jet eductor to mix the oxidant solution with water to be treated, and a time clock if the unit is to operate on less than a continuous basis. The installation is relatively simple compared with installing a conventional chlorination system. No hazardous materials need to be procured or stored.

Potential Applications

This small, rugged, simple water treatment unit could be utilized in many locations because it is independent of a developed power grid, of trained maintenance personnel, of hazardous or imported chemical supply, and of adjacent industrial support. Some potential applications include

- remote permanent locations,
- mobile exploration teams,
- natural disaster relief operations,
- military units, and
- shipboard installations.

A major industrial application is its use in cooling water systems as a replacement for toxic algicides such as chromates.

4. Advantages of a Liquid Mixed-Oxidant System

LATA's water treatment system differs from several other systems in that mixed oxidants are produced and used in a dissolved form. This offers several advantages, including the fact that liquids are more readily contained and monitored than gases. Gas leaks constitute a real hazard in commercial installations that use gaseous chlorine or ozone. When gas-phase oxidants are introduced into water, the oxidants must be transferred from gas bubbles into the liquid phase before becoming effective. The velocity of the transfer is proportional to the surface area of the bubbles. In industry, the transfer of materials from gas to liquid is facilitated by creating tiny bubbles and by increasing the turbulence of the liquid phase with a stirrer or static mixer. These methods require additional input of energy. In contrast, a solution of mixed oxidants

mixes rapidly and completely with water to be treated. Here, additional energy is not required for mixing. The oxidant solution is easy to contain and easy to measure. Any liquid leaks are readily detected and, with this system, can be readily repaired as previously proven during operational testing.

The mixed-oxidant solution is introduced into water to be treated immediately after it is produced. This allows even the short-lived oxidants that are electrolytically produced to contribute to the effectiveness of the method in achieving rapid kills of microorganisms. Systems that incorporate some time lag between production and utilization of the oxidants may lose the synergistic effect of any short-lived oxidants.

Another advantage to this flow-through system is that the discard stream is not highly caustic, the pH is around 9. The discard stream can be treated as wastewater. Some systems that produce gas-phase oxidants generate a large amount of hydrogen gas along with the chlorine or hypochlorite, leaving a very caustic NaOH residue that cannot be discarded without special precautions.

#### 5. Electrolytic Production of Mixed Oxidants

Our studies have shown that mixture of oxidants may be more effective against a mixed population of microorganisms than a single oxidant and thus may offer significant advantages in treating potable water.

Different types of microorganisms show the greatest sensitivity to different disinfectants, as shown in Table 2. Although ozone is the overall most effective of the disinfectants shown, chlorine as hypochlorous acid is more effective against viruses (Grayson, 1981). Spores and cysts are difficult to kill by any means. As a bactericidal agent, ozone acts rapidly by lysing the cell wall; whereas, chlorine kills more slowly by diffusing into cells and inactivating the enzyme systems (EPA, 1979). The simultaneous production of several oxidant species, then, could be a real advantage in a water treatment system.

The electrolytic process by which oxidants are generated in LATA's water treatment system depends upon Group VIII metal electrodes (the platinum group) that act as catalytic surfaces to produce free chlorine, hydrogen peroxide, hypochlorite, and strong but short-lived oxidants tentatively identified as ozone and free radicals from NaCl solutions. A typical composition of the mixed-oxidant solution is shown in Table 3.

TABLE 2

COMPARISON OF OXIDANT DISINFECTION EFFICIENCY AT 5°C

Disinfectant	Organism			
	Enteric Bacteria	Virus	Spores	Amoebic Cysts
O <sub>3</sub>	500	0.5	2	0.5
Cl <sub>2</sub> (as HOCl)	20	1.0	0.05	0.05
Cl <sub>2</sub> (as OCl <sup>-</sup> )	0.2	<0.02	0.0005	0.005
Cl <sub>2</sub> (as HO <sub>2</sub> Cl)	0.1	0.005	0.002	0.02

\*Source: Grayson, M. "Ozone," in Kirk-Othmer Encyclopedia of Chemical Technology, Volume 16, 3rd ed., John Wiley & Sons, NY, 1981.

Under a Small Business Innovative Research (SBIR) grant from the U.S. Navy, investigations were made using electrodes made of platinum, iridium oxide, and ruthenium oxide. Under identical conditions, the iridium oxide electrodes produced the greatest concentrations of chlorine and short-lived oxidants.

TABLE 3

COMPONENTS OF MIXED-OXIDANT SOLUTION\*

Component	Concentration (mg/l)	Analysis Method
Cl <sub>2</sub>	385	Phenylarsine titration
H <sub>2</sub> O <sub>2</sub>	200	UV absorbance (290 nm)
HOCl	trace	Phenylarsine titration
Short-Lived Oxidants (O <sub>3</sub> , Free Radicals)	30	Indigo trisulfonate dye decolorization (600 nm)

\*Conditions: 0.75 M NaCl solution; flow rate, 30 l/hr; IrO<sub>2</sub> electrodes, 12 V dc, 14 A

The concentration of oxidant species produced is related to the current flow across the electrolytic cell, as shown in Figure 3. The data shown were generated using the prototype unit shown earlier, except that a variable power source was used.

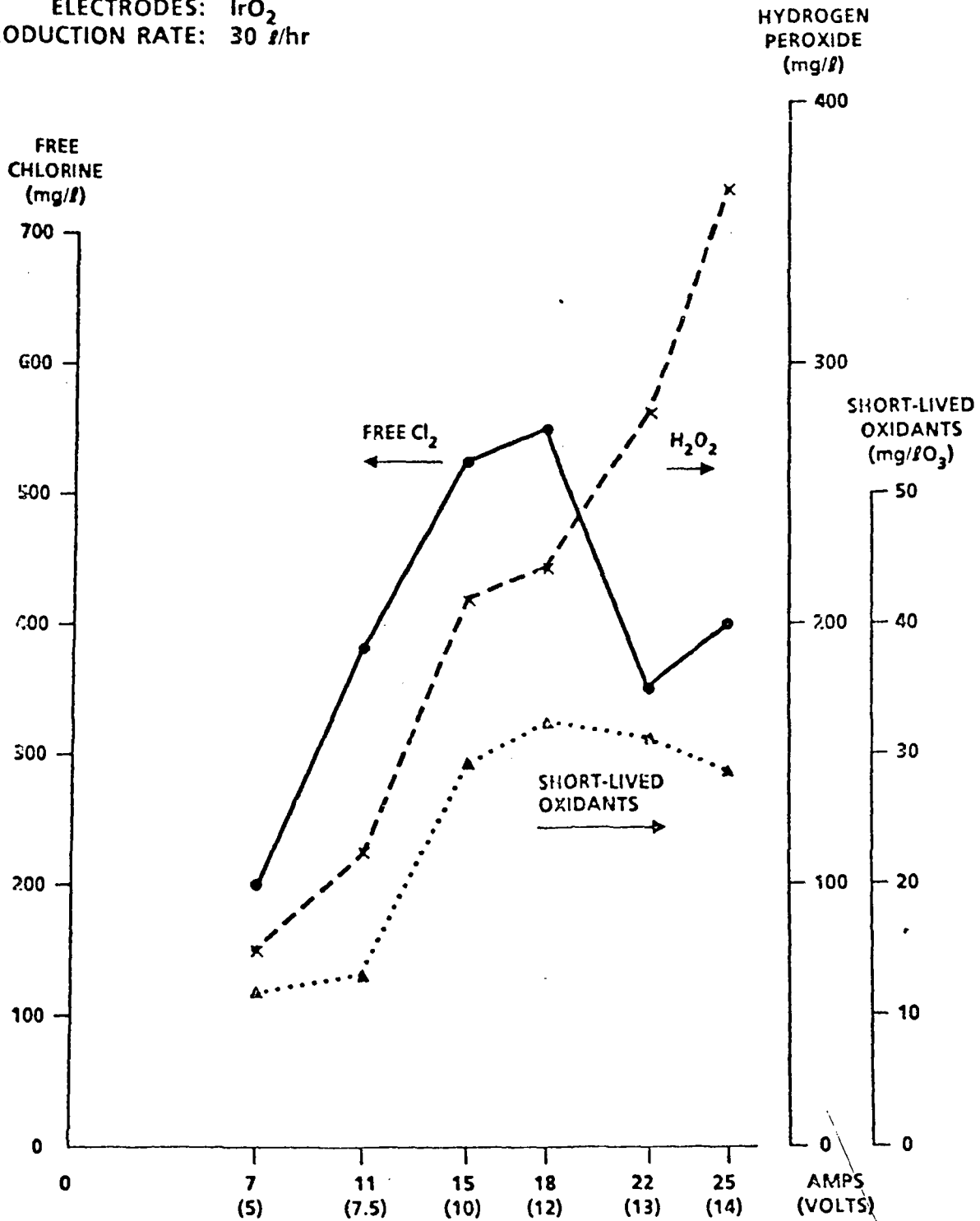


PROTOTYPE WATER TREATMENT UNIT

ELECTROLYTE: 0.75M NaCl (30 g/l) IN DISTILLED WATER

ELECTRODES: IrO<sub>2</sub>

PRODUCTION RATE: 30 g/hr



04 R500103 (G01)

Figure 3. Influence of Electrical Current on Oxidant Stream Composition

The catalytic reactions taking place on the electrode surfaces are not completely characterized. Possible reactions, derived from the electrochemistry literature, are shown in Table 4.

The generation of short-lived oxidants is supported by dye decolorization studies. Bleaching of indigo trisulfonate dye has been proposed as a test for ozone (Bader and Hoigne, 1981). Although this reaction is not specific for ozone, the reaction rate of the dye with the mixed-oxidant solution suggests that strong oxidant components are produced in addition to chlorine and shows why immediate mixing of the oxidant solution with water to be treated is of the utmost importance (Figure 4). Very rapid dye oxidation occurs within the initial minutes after the mixed-oxidant solution is produced.

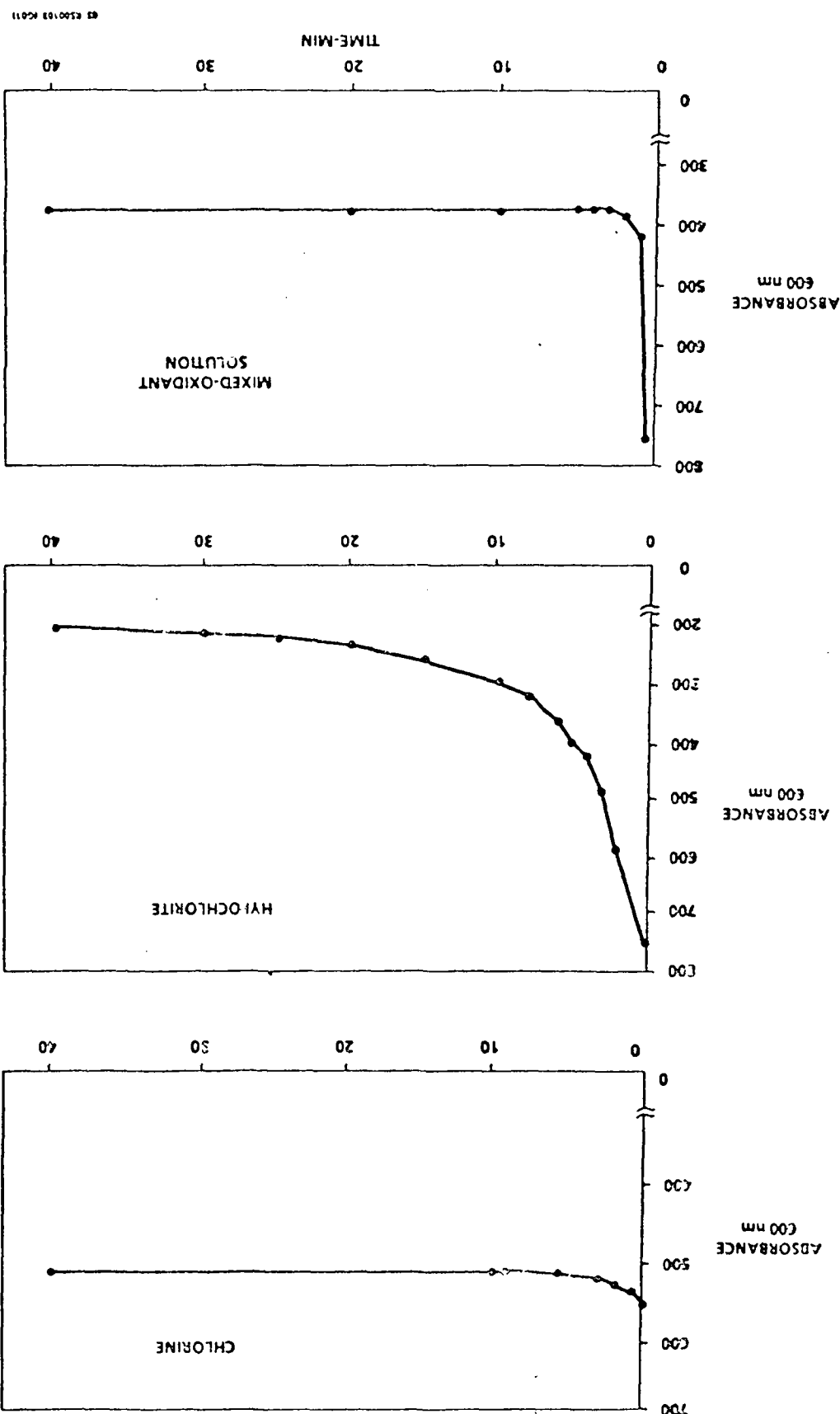
TABLE 4

POSSIBLE OVERALL ELECTROLYTIC REACTIONS

<u>Cell Location</u>	<u>Reactions</u>
Feed Solution	$\text{NaCl} \rightarrow \text{Na}^+ + \text{Cl}^-$
Anode	$2 \text{Cl}^- \rightarrow \text{Cl}_2 + 2\text{e}$ $4\text{OH}^- \rightarrow \text{O}_2 + 2\text{H}_2\text{O} + 4\text{e}$ $\text{O}_2 + \text{O}^{\cdot} \rightarrow \text{O}_3$ $\text{H}_2\text{O} + \text{O}^{\cdot} \rightarrow \text{H}_2\text{O}_2$
Cathode	$2\text{H}_2\text{O} + 2\text{e} + 2\text{OH}^- \rightarrow \text{H}_2$ $\text{O}_2 + 2\text{e} + 2\text{O}^{\cdot}$
Between the Electrodes	$\text{Cl}_2 + 2\text{OH}^- \rightarrow \text{H}_2\text{O} + \text{OCl}^- + \text{Cl}^-$

This oxidation is produced even faster than that seen with either chlorine or hypochlorite alone. This empirical evidence supports the possible reactions of the electrolytic cell shown in Table 4. Ozone is known to be very short-lived; the half-life is less than one hour at pH 8 (Glaze, 1987) and is shorter in more alkaline conditions. The shorter the time lag between generating the mixed-oxidant solution and contacting it with contaminated water, the greater the capacity to oxidize the contaminants. LATA's water treatment system is designed to utilize the short-lived oxidants; whereas,

Figure 4. Rate of Indigo Trisulfonate Dye Decolorization Due to Chlorine, Hypochlorite, and Oxidant Solution



systems that provide storage tanks for the oxidants, which are to be mixed with water at some later time, probably lose these components if generated.

The mixture of cogenerated oxidants provides a powerful tool for treating potable water. Ozone is known to be particularly effective in killing many types of microorganisms. Hydrogen peroxide has been observed to increase the effectiveness of ozone in removing organic substances during water treatment (Glaze, 1987). However, ozone has a short lifetime and provides no long-term protection in treated water. Chlorine provides long-term protection against recontamination, and the presence of chlorine shows that the water has been treated as its concentration is readily measured colorimetrically.

#### 6. Effectiveness of Mixed-Oxidant Solution Against Microorganisms

The real test of a water treatment system is its effectiveness against microorganisms, particularly waterborne human pathogens. The mixed-oxidant solution produced by LATA's water treatment system has been tested against a range of microorganisms, including cysts and spores that are difficult to kill at usual levels of municipal chlorination. To test the effectiveness of the freshly generated oxidant solution, known volumes were added to suspensions of known microorganisms. The treatment ratio, or ratio of oxidant solution to contaminated water, was chosen to initially provide a low level of free chlorine at the lower end of the recommended range, which is 0.2- to 4-mg/l (USPHS, 1984) to test for effectiveness of the non-chlorine species. With the prototype water treatment unit, the mixed-oxidant solution contained sufficient chlorine; as little as one volume of oxidant solution was mixed with 1,000 volumes of contaminated water. All tests were carried out using standard methods of analysis (Greenberg et al., 1980).

A series of six tests were performed. The first three tests were carried out using electrolytic cells which were of different dimension and design and were equipped with platinum electrodes. Also, the mixed oxidants were measured using nonspecific tests--first titration with sodium thiosulfate and later by total decolorization of indigo trisulfonate dye. The last three tests were made using the prototype unit shown in Section 1, which was equipped with iridium oxide electrodes. Short-lived oxidants were measured as the difference in the quantity of dye decolorized by a freshly generated solution of mixed oxidants and by the same solution aged 24 hr in a filled, tightly closed container.

A comparison was made of the effectiveness of the mixed-oxidant solution and calcium hypochlorite against Escherichia coli (Table 5). The mixed-oxidant solution showed a more complete kill after 1 min; after 5 min, kill was complete in both treatments.

Legionella pneumophila, the agent that causes Legionnaires' Disease, can survive acceptable levels of chlorination for potable water systems and is quite difficult to kill in evaporative cooling systems. The mixed-oxidant solution was more effective against this organism than were similar concentrations of chlorine dioxide and hypochlorous acid (Table 6).

TABLE 5  
COMPARISON OF ESCHERICHIA COLI KILL BY MIXED-OXIDANT  
AND HYPOCHLORITE SOLUTIONS

Solution	Initial Oxidant* (mg/l)	Cl <sub>2</sub> (mg/l)	T <sub>0</sub>	E. coli CFU/ml	
				T <sub>1</sub> min	T <sub>5</sub> min
Mixed Oxidant (0.75 M NaCl; 9.5 A)	0.10	1.1	10 <sup>6</sup>	1.5 x 10 <sup>4</sup>	<1
Ca (OCl <sub>2</sub> ) <sub>2</sub>	0.03	1.2	10 <sup>6</sup>	1.7 x 10 <sup>5</sup>	<1

\* Oxidant measured by Na<sub>2</sub>S<sub>2</sub>O<sub>3</sub> titration

TABLE 6  
COMPARISON OF OXIDANTS' EFFECTIVENESS AGAINST  
LEGIONELLA PNEUMOPHILA

Solution	Total Oxidant (mg/ml)	Cl <sub>2</sub> Concentration (mg/l)	T <sub>0</sub>	L. pneumophila CFU/ml		
				T <sub>2</sub> min	T <sub>5</sub> min	T <sub>15</sub> min
Mixed Oxidant (0.075 M NaCl, 20 V, 7 A)	0.75	0.49	1 x 10 <sup>7</sup>	1.9 x 10 <sup>6</sup>	1.5 x 10 <sup>4</sup>	3.0 x 10 <sup>2</sup>
ClO <sub>2</sub>	0.75	0.20	1 x 10 <sup>7</sup>	2.0 x 10 <sup>6</sup>	1.0 x 10 <sup>3</sup>	1.0 x 10 <sup>3</sup>
HOCl	0.67	0.23	1 x 10 <sup>7</sup>	8.0 x 10 <sup>6</sup>	6.0 x 10 <sup>6</sup>	1.0 x 10 <sup>6</sup>

Giardia, a cyst-forming trophozoite that is parasitic in the mammalian gut, has become a serious human health concern in the U.S. in recent years. The cysts can be spread through fecal contamination of fresh water and enter municipal water treatment systems where they have proved extremely resistant to conventional chlorination treatment, especially at low temperatures. Several outbreaks of debilitating human diarrhea in urban areas have been traced to Giardia contamination of municipal water supplies. Newly proposed standards for U.S. drinking water specify less than one Giardia cyst/100 ml.

To test the effectiveness of the mixed-oxidant solution against cysts, an experiment was carried out using Giardia muris, the mouse infective species. This species is slightly more difficult to kill than the human pathogen, Giardia lamblia, and is easier to maintain in culture as the mice are asymptomatic. Viability and infective potential in Giardia is shown by the live trophozoites excysting under standard incubation conditions that simulate passage through the mammalian gut. This test compared the number of organisms able to excyst when contaminated water was treated with the mixed-oxidant solution. The water conditions investigated were cold, clear water (3°C); warm, clear water (20.5°C); and cold, turbid water (3°C). In order to assess the effects of other oxidants, the free chlorine levels were kept very low. A minimum of 500 cysts were inspected for each treatment. In the cases where kill was thought to be complete, all of the approximately 4,500 cysts per treatment were scanned, for certainty.

The mixed-oxidant solution was able to kill all Giardia cysts in cold and warm clear water, although the free chlorine concentrations were at the lower end of the municipal treatment range (Table 7). The total kill in cold water at 0.40 mg/l chlorine content is especially significant as it suggests the effectiveness of short-lived oxidants. The concentration of cysts used in these tests was very high--about 4,500 cells in 50 ml of water. Under field conditions where contamination is less severe, complete kill even in cold, turbid water seems feasible.

The final three tests discussed were performed with the pilot water treatment unit shown earlier. Based on the foregoing successes in killing even very resistant microorganisms, these tests were designed to show whether a very small proportion of the mixed-oxidant solution mixed with contaminated water could kill all microorganisms and produce treated water that meets U.S. standards for drinking water for residual chlorine and maximum recommended levels for sodium and chloride content. The EPA standard for chlorine residual is 0.2- to 4-mg/l (EPA, 1986). The U.S. Public Health

TABLE 7

EFFECT OF MIXED-OXIDANT SOLUTION ON GIARDIA EXCYSTATION

Tested Water Condition	Temp. °C	Total Oxidant (mg/l)	Cl <sub>2</sub> Concentration (mg/l)	% <u>Giardia</u> Viability ( $\frac{\text{Excysted cells}}{\text{Total cells}} \times 100$ )		
				T <sub>0</sub>	T <sub>10 min</sub>	T <sub>30 min</sub>
Clear	3	0.40	0.44	40	24	0*
		0.20	0.22	44	41	19
Clear	20.5	0.44	1.14	58	4	0*
		0.22	0.57	60	12	3
Turbid	3	0.35	0.74	48	10	6
		0.18	0.37	42	49	44

\* All ~4500 cysts of this treatment were examined to verify 100% kill.

Service recommends a maximum for chloride of 250 mg/l (USPHS, 1984); the average taste threshold is 400 mg/l (McKee and Wolf, 1978). The National Academy of Sciences recommends a maximum sodium content in water of 200 mg/l for persons on sodium-restricted diets (NAS-NRC, 1973).

E. coli were successfully killed within 10 min when one volume of mixed-oxidant solution was added to 1,000 volumes of contaminated water (Table 8). The mixed-oxidant solution was proded at 30 l/hr in 0.75 M NaCl using 13.4 A, 12 V dc. The calculated concentrations of interest were chlorine, 0.3 mg/l; sodium, 17 mg/l; and chloride, 12 mg/l, easily meeting the drinking water parameters.

Pseudomonas aeruginosa causes eye infections in humans. American Type Culture Collection (ATCC) Strain #15442 was selected as a test organism because this strain has been identified as having broad resistance to commercial germicides and is specified for disinfectant testing by the American Organization of Agricultural Chemists (AOAC).

Cell suspensions of P. aeruginosa were successfully killed within 10 min when one volume of mixed-oxidant solution was added to 1,000 volumes of contaminated water (Table 9). The oxidant production and final parameters of water quality were the same as the preceding test, indicating successful treatment.

TABLE 8  
INFLUENCE OF MIXED-OXIDANT SOLUTION ON ESCHERICHIA COLI

Mixed-Oxidant Solution Generating Conditions <sup>a</sup>	Treatment Ratio		Initial Cl <sub>2</sub> (mg/l)	Initial Short-Lived Oxidants (mg/l)	E. coli <sup>b</sup> CFU/100 ml	
	Oxidant : Solution	Contaminated Water			T <sub>0</sub>	T <sub>10 min</sub>
13.5 A, 12 V	1	750	0.4	0.02	8.5 x 10 <sup>3</sup>	<1
	1	1000	0.3	0.01	8.5 x 10 <sup>3</sup>	<1
Control	0	1000	0	0	8.5 x 10 <sup>3</sup>	8.5 x 10 <sup>3</sup>

a. The mixed-oxidant solution was produced from 0.75 M NaCl at 30 g/hr using IrO<sub>2</sub> electrodes.

b. E. coli Strain EPA #00728



TABLE 9

INFLUENCE OF MIXED-OXIDANT SOLUTION ON PSEUDOMONAS AERUGINOSA

Mixed-Oxidant Solution Generating Conditions <sup>a</sup>	Treatment Ratio Oxidant : Contaminated Solution : Water	Initial Cl <sub>2</sub> (mg/l)	Initial Short-Lived Oxidants (mg/l)	P. aeruginosa <sup>b</sup>	
				T <sub>0</sub>	CFU/100 ml T <sub>10</sub> min
13.5 A, 12 V	1 : 750	0.4	0.02	6.8 x 10 <sup>4</sup>	<1
	1 : 1000	0.3	0.01	6.8 x 10 <sup>4</sup>	<1
Control	0 : 1000	0	0	6.8 x 10 <sup>4</sup>	6.8 x 10 <sup>4</sup>

a. The mixed-oxidant solution was produced from 0.75 M NaCl at 30 l/hr using IrO<sub>2</sub> electrodes.  
 b. P. aeruginosa ATCC Strain #15442

Although not a human pathogen, Bacillus subtilis is a well-known spore forming organism. Spores, like cysts, are extremely difficult to kill by normal methods of disinfection; spores can survive in boiling water and in levels of chlorine common in municipal drinking water. B. subtilis ATCC Strain #19659 was selected as a test organism because this strain is specified for use in the AOAC standard sporicide test. The cells were grown on standard nutrient agar slants for 96 hr at 30°C. Permanent slide mounts were prepared, stained, and examined to verify the extent of sporulation, which was estimated at 90% to 95% at 96 hr.

Because of the known resistance of the spores, suspensions of B. subtilis spores were mixed with oxidant solutions over a wide treatment range. After 20 min, spore populations were significantly reduced, but kill was not complete (Table 10). However, one volume of mixed-oxidant solution in 500 volumes of contaminated water was sufficient to kill all spores after 20 hr. As in the two tests above, the treated water met drinking water parameters. This test will be repeated to determine the minimum, required contact time, especially by the mixture of one volume of oxidant to 1,000 volumes of contaminated water. This interval must be taken into consideration when designing a municipal water treatment system. Sufficient residence time must be allowed for total disinfection before the water is used.

To summarize the effectiveness of LATA's unique water treatment system, the mixed-oxidant solution is very effective against a spectrum of microorganisms, including cysts and spores. Test organisms were selected to provide worst-case challenges. Virus tests have yet to be conducted because of the need for special facilities. Although all major human pathogens have not been tested, the results thus far indicate that potable water can be produced using a mixed-oxidant solution and that the water will meet U.S. drinking water standards and recommendations and aesthetic guidelines for residual chlorine, coliform bacteria, chloride, and sodium content.

TABLE 10  
INFLUENCE OF MIXED-OXIDANT SOLUTION ON BACILLUS SUBTILIS SPORES

Mixed-Oxidant Solution Generating Conditions	Treatment Ratio		Initial Cl <sub>2</sub> (mg/l)	Residual Cl <sub>2</sub> (24 hr) (mg/l)	Initial Short-Lived Oxidants (mg/l)	B. subtilis <sup>b</sup> CFU/100 ml		
	Oxidant Solution	Contaminated Water				T <sub>0</sub>	T <sub>20min</sub>	T <sub>20hr</sub>
13.5 A, 12 V	1	: 75	4.0	2.0	0.16	2.3 x 10 <sup>4</sup>	2.0 x 10 <sup>3</sup>	<1
	1	: 150	2.0	2.0	0.08	2.3 x 10 <sup>4</sup>	5.0 x 10 <sup>3</sup>	<1
	1	: 300	1.0	1.0	0.04	2.3 x 10 <sup>4</sup>	TNTCC	<1
	1	: 500	0.6	0.5	0.02	2.3 x 10 <sup>4</sup>	TNTCC	<1
	1	: 750	0.4	NA <sup>d</sup>	0.02	2.3 x 10 <sup>4</sup>	1.5 x 10 <sup>4</sup>	NA
	1	: 1000	0.3	NA	0.01	2.1 x 10 <sup>4</sup>	1.4 x 10 <sup>4</sup>	NA
Control	0	: 1000	0	0	0	2.3 x 10 <sup>4</sup>	NA	4.9 x 10 <sup>3</sup>

- a. The mixed-oxidant solution was produced from 0.75 M NaCl at 30 l/hr using IrO<sub>2</sub> electrodes.
- b. B. subtilis ATCC Strain # 19659
- c. TNTC = Too Numerous To Count (In samples taken)
- d. NA = Not Available

REFERENCES

Bader, H. and J. Hoigne, "Determination of Ozone in Water by the Indigo Method," Water Research, Vol. 15, pp. 449-456, 1981.

EPA (U.S. Environmental Protection Agency), "The Disinfection of Drinking Water," Prepared for Environmental Protection Agency, PB80-112964, 1979.

EPA (U.S. Environmental Protection Agency), "National Interim Primary Drinking Water Regulations," Code of Federal Regulations, 40 CFR 141, July 1986.

Evans, F. L., III, "Ozone Technology: Current Status," In Ozone in Water and Wastewater Treatment, F. L. Evans III, Ed., Ann Arbor Science, Publishers, Ann Arbor, MI, 1972.

Glaze, W. H., "Drinking-Water Treatment with Ozone," Environ. Sci. Technol., Vol. 21 (3): 224 - 230, 1987.

Grayson, M. Ed., "Ozone," In Kirk-Othmer Encyclopedia of Chemical Technology, Vol. 16, 3rd ed., John Wiley & Sons, New York, N.Y. 1981.

Greenberg, A. G., ed., "Standard Methods for the Examination of Water and Wastewater," 15th ed., American Public Health Association, 1980.

McKee, J. E. and H. F. Wolf, "Water Quality Criteria," 2nd ed., California State Water Resources Control Board, Publication 3A:160, Reprinted July, 1978.

NAS-NRC (National Academy of Sciences - National Research Council), Environmental Studies Board, "Water Quality Criteria," EPA Report EPA-R3-73-033. Washington, D.C., 1973.

Pendergrass, A. M., H. F. Gram, M. E. Muller, P. A. Rink, and M. W. Talley, "Electrolytic Sterilization of Potable Water on Shipboard," Final Technical Report, Contract No. N00167-85-C-0001, SBIR, 1985.

USPHS (U.S. Public Health Services), "Drinking Water Standards," Code of Federal Regulations 42 CFR 72, July 1984.

# The Chemistry of Water Treatment Processes Involving Ozone, Hydrogen Peroxide and Ultraviolet Radiation

William H. Glaze, Joon-Wun Kang and Douglas H. Chapin

Environmental Science and Engineering Program  
School of Public Health, University of California  
Los Angeles, CA 90024

## Abstract

Advanced oxidation processes are defined as those which involve the generation of hydroxyl radicals in sufficient quantity to affect water purification. The theoretical and practical yield of OH from  $O_3$  at high pH,  $O_3/H_2O_2$ ,  $O_3/UV$  and  $H_2O_2/UV$  systems is reviewed. New data is presented which illustrates the importance of direct photolysis in the  $O_3/UV$  process, the effect of the  $H_2O_2:O_3$  ratio in the  $O_3/H_2O_2$  process, and the impact of the low extinction coefficient of  $H_2O_2$  in the  $H_2O_2/UV$  process.

## Introduction

This paper will summarize the chemistry of several water treatment processes involving combinations of ozone, hydrogen peroxide and ultraviolet radiation. The purpose is to show that these processes have much in common mechanistically, but there are significant enough differences to make one or the other more practical depending on water quality and water treatment goals.

## Advanced Oxidation Processes

Ozone has been used as a chemical reagent, an industrial chemical, and an oxidant for water treatment for over eight decades (1). Ozone is known to be a powerful oxidant and disinfectant, with a thermodynamic oxidation potential that is the highest of the common oxidants. In principle, ozone should be able to oxidize most inorganic substances to their highest stable oxidation states and organic compounds to carbon dioxide and water. In actual practice, however, ozone is quite selective in its oxidation reactions. In organic chemistry it is most useful for cleavage of multiple bonds and aromatic systems, but even in these cases the rates of oxidation may be quite slow for water treatment applications. For example, ozone reacts slowly with many types of water contaminants such as alicyclic taste and odor compounds as geosmin and MIB (2), aliphatic halides such as the THMS (3,4), and unactivated aromatics such as chlorinated benzenes (4). In water treatment, ozone has been most successful for enhancing the pleasant taste of water, for aiding coagulation and filtration processes, and as a first barrier to microor-

ganisms.

There is, however, a new dimension emerging in the use of ozone in water treatment. In several laboratory and pilot scale studies ozone is now being combined with hydrogen peroxide and ultraviolet radiation to produce results which have not been possible with ozone alone. The literature is replete with examples of  $O_3/UV$  and  $O_3/H_2O_2$  studies in which inorganic and organic substances have been oxidized much more effectively than one can accomplish with ozone or any other common oxidant. We now understand, based on the accumulation of new information on the basic chemistry of ozone, that the success of these new processes is due to the intermediacy of the hydroxyl radical which is common to each system. We shall refer to systems such as  $O_3/UV$  and  $O_3/H_2O_2$  as "Advanced Oxidation Processes" and include in this category other processes which generate the hydroxyl radical, namely ozone at high pH values, hydrogen peroxide with UV radiation, and ozone or hydrogen peroxide with other hydroxyl radical initiators such as metals and metal oxides.

#### Historical Background

Prengle and coworkers at Houston Research Inc. (HRI) were the first to see the commercial potential of the  $O_3/UV$  system. HRI showed that  $O_3/UV$  enhances the oxidation of complexed cyanides, chlorinated solvents, pesticides, and miscellaneous group parameters such as COD and BOD (5-8). Subsequently, the process was also commercialized by Westgate Research of Los Angeles (now ULTROX) where Zeff and coworkers further extended the applications of the process (9,10). Glaze and coworkers, especially Peyton, have examined the  $O_3/UV$  process for oxidation of a number of halogenated micropollutants (3,11) and THM precursors (12) and have carried out basic studies to elucidate the mechanisms of the process (13). Several other groups have used the  $O_3/UV$  process for oxidation of a variety of organic pollutants (14-17) and the process has been taken to pilot scale for a number of applications (5,18, 19).

The  $O_3/H_2O_2$  system was investigated early by Nakayama et al. (20) and Hango et al. (21) for wastewater treatment, and more recently by Bollyky (22), Brunet et al. (23) and Duguet et al. (24) for drinking water treatment. Duguet et al. showed that addition of peroxide enhanced the efficiency of oxidation of several organic substances, THM precursors, and also increased the rate of ozone transfer. Studies are proceeding currently in several laboratories including our own (25), and the process is being taken to pilot scale by the city of Los Angeles for removal of tri- and tetrachloroethylene in groundwater.

Hydrogen peroxide with ultraviolet radiation was studied by Berglind *et al.* (26) for the oxidation of humic substances, methylisoborneol, 3,4-benzopyrene (sic), chloroform and bromodichloromethane. The process is the subject of a U.S. patent (27) but little further work has been reported.

### Mechanisms of Advanced Oxidation Processes

Not all of the advanced oxidation systems have been well studied and their mechanisms are not fully elucidated. It appears, however, that all involve the generation of the hydroxyl radical. The present view is that the oxidizing capability of these systems is differentiated from other common oxidants such as chlorine, chlorine dioxide, etc. because of the very high reactivity of this radical.

#### OZONATION AT HIGH pH VALUES

Hydroxyl radicals were postulated by Weiss (28) as intermediates in the base catalyzed decomposition of ozone. Indirect evidence for OH radicals was presented by Hoigné and Bader (29) who showed that the mechanism of ozonation seemed to change at high pH values. The relative rate constants for high pH ozonation of pairs of organic compounds were found to be the same as those for reaction of the same compounds with hydroxyl radicals generated from radiolysis of water. Hoigné's group (30-32) and independently, Hart *et al.* (33-34) used advanced spectro-kinetic methods to elucidate the mechanism by which ozone decomposes in water. A complex chain mechanism was revealed that involves a series of single-electron and atom transfer processes (Figure 1) and the intermediacy of OH radicals. Staehelin and Hoigné showed that a variety of substances can initiate the chain including hydroxide, hydroperoxide, formate and ferrous ions, and even humic substances (35). Although direct spectroscopic evidence for the OH radical in aqueous ozone systems has not been found, the indirect evidence is overwhelming that OH is the key reactive intermediate when ozone decomposes in water.

In very pure water OH reacts with ozone so that the chain propagating steps shown in the circle in Figure 1 can repeat again and again. Hundreds of ozone molecules may be decomposed by a single initiation step. The result is that ozone can have a very short half-life in distilled water at pH 7 (36). In the presence of common water contaminants, for example bicarbonate, carbonate and the organic constituents of humic substances, the cycle can be broken by trapping of the hydroxyl radical, and of course, the chain may also be broken by radical-radical coupling processes.

Rate constants for reaction of OH with most substances are extremely large indicating that the reactions are very fast; some occur almost every time an OH radical collides with a molecule of the substance. One of the major water contaminants, bicarbonate will trap hydroxyl radicals with such efficiency that the half-life of ozone in distilled water at pH -7 increases from about  $10^3$  seconds in distilled water to  $10^4$  seconds in 2 mM  $\text{HCO}_3^-$  (36).

If organic micropollutants are present when ozone decomposes they too will react with hydroxyl radicals, but they must compete with all of the other OH traps present. If the concentration of the micropollutant organics is in the micromolar range or below, they may be at a distinct disadvantage compared to matrix contaminants such as bicarbonate or humic materials, which may be present at concentrations several orders of magnitude higher (35).<sup>1</sup>

As Hoigné and coworkers have observed, the mechanism of the reaction of ozone with another substance M may involve both direct reactions of M with ozone and reaction of M with OH radicals, even if the pH of the system is near neutral (35). This is because OH-promoters such as hydrogen peroxide and superoxide ion  $\text{O}_2^-$  are formed in the course of direct ozonation processes. Also, there may be contaminants in the water which act as promoters. Thus, when ozone reacts with substances in natural waters it is almost surely reacting by a combination of direct  $\text{O}_3$  and OH pathways, the relative proportions of which will depend on the various contaminants present or added. The mechanism may even become more radical in character as the reaction proceeds.<sup>2</sup>

At higher pH values there is an important factor that works against the effectiveness of ozonation processes. Hoigné has pointed out that increasing the pH will not necessarily increase the rate of OH radical destruction of a substrate because of enhanced trapping effects (29). At pH values

---

<sup>1</sup> In the  $\text{O}_3/\text{H}_2\text{O}_2$  oxidation of TCE in the presence of 300 mg/L (as  $\text{CaCO}_3$ ) of bicarbonate, we calculate that only about 4% of the transferred ozone is utilized for the destruction of 90% of 600 ug/L of TCE (25).

<sup>2</sup> This may explain apparent discrepancies in the literature on such questions as the destruction of THM formation potential by ozonation, where some workers see an enhancement of THMFP by ozone and others do not (37). Under some conditions OH radicals apparently are produced by initiators present in the water and these radicals may hydroxylate benzenoid species to form THM precursors. Under other conditions the radicals are either not formed in such abundance or are quenched by other species (38).

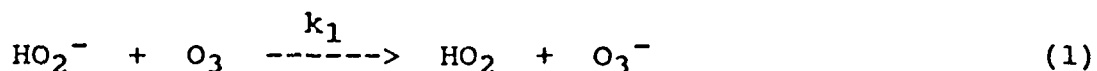


greater than 10.3 carbonate is a more prevalent species than bicarbonate and the rate constant of OH with carbonate is over twenty times greater than with bicarbonate. On the other hand, ozonation is not commonly carried out at pH values above 10.3, so the role of carbonate may not be very severe as these considerations indicate.

Further studies are needed to carefully document the advantages and disadvantages of using high pH conditions to enhance ozonations in waters with different alkalinity values. Figure 2 shows data from a study being carried out in our laboratory where the rate constant for ozonation of trichloroethylene is measured in a CSTR treating a high alkalinity ground water from a well in North Hollywood (alkalinity 200 mg/L as CaCO<sub>3</sub>; pH 7.3; DOC 1.1 mg/L; Fe, Mn less than 0.1 ppm). As figure 2 shows, adjusting the pH from 4 to 10 has little effect on the destruction of TCE. We suspect that this behavior may be due to a cancellation of the promoting effect of hydroxide ion and the scavenging effect of carbonate vs. bicarbonate, and therefore may not be typical behavior for a water of lower alkalinity. However, the results illustrate that rate enhancements from pH changes below 10 or 11 may be minimal.

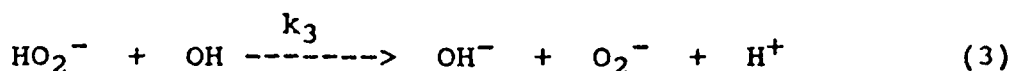
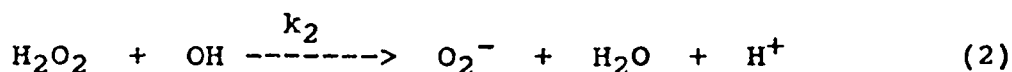
#### OZONE WITH HYDROGEN PEROXIDE

Hart and coworkers (33) and Staehelin and Hoigné (30) showed that the conjugate base of H<sub>2</sub>O<sub>2</sub> can initiate the ozone decomposition cycle by a single electron transfer process involving the conjugate base of hydrogen peroxide HO<sub>2</sub><sup>-</sup>:



This initiates the decomposition of ozone resulting, in the formation of hydroxyl radical. Exploiting this effect, Duguet et al. (24) showed that the efficiency of color removal by ozone is accelerated by hydrogen peroxide. The dependence on the concentration of peroxide suggests that H<sub>2</sub>O<sub>2</sub> is acting as a scavenger at high concentrations. In recent studies in our laboratory we are exploring the O<sub>3</sub>/H<sub>2</sub>O<sub>2</sub> system with several substrates including chloroethenes and several taste and odor compounds. Figure 3 shows rate data for the destruction of tetrachloroethylene in a ground water from the same area in Los Angeles from which the sample was taken referred to earlier. The alkalinity of this water is somewhat higher than the other (300 mg/L at CaCO<sub>3</sub>) but other water quality parameters are similar. In these experiments, to be reported in more detail later, the peroxide and ozone were simultaneously fed into the reactor, ozone and peroxide residuals were generally below 0.1 ppm, and ozone utilization

greater than 90%). The pseudo first-order rate constants show a hyperbolic dependence on peroxide with a maximum at a ratio of about one mole of peroxide per mole of ozone. This is the function expected if peroxide acts as a promoter as well as an OH scavenger. Indeed, it is known that peroxide will act as an OH radical trap as well as an initiator. The rate constant for reactions 2 and 3 are  $2.7 \times 10^7 \text{ M}^{-1} \text{ s}^{-1}$  and  $7.5 \times 10^9 \text{ M}^{-1} \text{ s}^{-1}$  respectively (39):



It should be noted, however, that superoxide ion  $\text{O}_2^-$  is also formed in equations 2 and 3, and since superoxide also promotes the decomposition of ozone it is not clear why peroxide inhibits the decomposition of TCE at high  $\text{H}_2\text{O}_2$  levels. If one assumes that superoxide reacts primarily by some other pathway than with ozone, then one may derive equation 4:

$$-d(\ln[M]/[M_0])/dt = k_0 \quad (4)$$

where

$$k_0 = \frac{k_M k_1 K_{\text{per}} [\text{H}_2\text{O}_2] [\text{O}_3] / [\text{H}^+]}{k_M [M] + (k_2 + k_3 K_{\text{per}} / [\text{H}^+]) [\text{H}_2\text{O}_2] + k_i [S_i]}$$

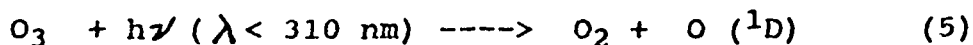
$K_{\text{per}}$  is the dissociation constant of hydrogen peroxide ( $1.6 \times 10^{-12}$ ),  $k_M$  is the rate constant for reaction of OH with substrate, in this case TCE or PCE, and  $S_i$  symbolizes other matrix components that trap OH with rate constants  $k_i$ , the most important of which are dissolved organic carbon (humic substances), bicarbonate or carbonate ion (36).

Alternatively, the shape of Figure 3 may be related to the fact that the reaction is being carried out in a CSTR. That is, at high peroxide doses the rate constant is mass transfer limited.

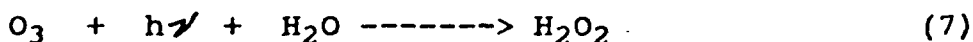
In any case, the results of the laboratory scale tests on the oxidation of TCE and PCE are so encouraging that the city of Los Angeles is currently sponsoring pilot scale tests to evaluate the large scale potential of the  $\text{O}_3/\text{H}_2\text{O}_2$  system for remediation of contaminated ground water in the San Fernando Valley (40).

OZONE WITH ULTRAVIOLET RADIATION

The photolysis of ozone in wet air produces hydroxyl radicals by a two step process (41):



Some workers assumed (8) that photolysis of ozone in water would proceed by a similar pathway; however Taube (42) showed, and more recently Peyton and Glaze (13,18) confirmed that this is not the case. Rather, hydrogen peroxide is formed in a process where OH radicals, if formed at all, do not escape from the solvent cage. The overall reaction is



Equation (7) would appear to say that the  $O_3/UV$  and  $O_3/H_2O_2$  processes are one and the same: in the former one is merely forming hydrogen peroxide in situ, rather than adding it from an external source. Indeed, for some substrates that is the case as will be discussed below. For other substrates which absorb ultraviolet radiation the  $O_3/UV$  process can be much more. This is illustrated by the  $O_3/UV$  oxidation of tetrachloroethylene, first reported by Peyton et al. (3) and more recently explored in a ground water matrix by our group in Los Angeles.

Tetrachloroethylene (PCE) absorbs ultraviolet radiation at 254 nm only weakly, but sufficiently so that direct photolysis is a significant contributor to the overall decay of PCE when the compound is exposed to ozone and 254 nm radiation in a CSTR reactor. Figure 4 is a plot of pseudo first-order rate constants for a series of runs where the ozone dose was varied while keeping the UV dose constant. For a given UV dose the data approximately fit a simple relationship

$$k_o = k_p + k_{ox}D^n = k_p + k' \quad (8)$$

where  $k_p$  is the direct photolysis constant,  $k_{ox}$  is related to the constant for OH radical reaction with PCE,  $D$  is the ozone dose rate, and  $n$  is a coefficient with a value near unity (3). The value of  $k_p$  obtained from an experiment in which  $D$  was zero (only oxygen was used) is in good agreement with the extrapolated value from Figure 4.

Similar experiments were carried out with trichloroethylene (TCE) with markedly different and revealing results. Figure 5 shows that the  $O_3/UV$  oxidation of TCE is only weakly dependent on the UV flux. The extrapolated value at zero ozone dose is in good agreement with the rate constant

obtained in the "UV only" experiments.

The TCE and PCE data from these experiments demonstrate what Prengle and coworkers claimed years ago(8): that the  $O_3/UV$  process is, at the same time, an oxidation process and a photolysis process. Figure 6 illustrates the various elements of the process including direct ozonation, decomposition of ozone (OH radical chemistry) and photolysis of M and hydrogen peroxide. The relative importance of these processes will depend on an extraordinary number of factors including: the intensity and wavelength of the UV radiation, the ratio of  $O_3:UV$  doses, the concentration of M, promoters and radical traps, and others.

When a substance absorbs strongly in the UV region large fluxes of UV radiation will accelerate the destruction of the substance. This is the case for PCE and presumably for other UV absorbing substances such as aromatic halides. For some photolytically labile substances such as some pesticides,  $k_p$  is so large that little is to be gained from using ozone.

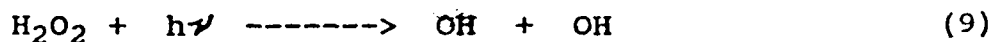
On the other hand, when the substance of concern is not photolyzed directly with much efficiency, the use of UV radiation to generate hydrogen peroxide makes little sense.<sup>3</sup> In such cases it is preferable to add hydrogen peroxide from an external source. Metering of peroxide into a water stream is a trivial task compared to the use of UV lamps with their attendant problems of clouding and flux decay especially for large water treatment plants. Our view is that both processes should be considered in a feasibility study, but except when direct photolysis is a major factor, the  $O_3/H_2O_2$  process is heavily favored.

#### HYDROGEN PEROXIDE WITH ULTRAVIOLET RADIATION

In principle, the most direct method for the generation of hydroxyl radicals is through cleavage of hydrogen peroxide, a relatively inexpensive and readily available chemical intermediate. Photolysis of hydrogen peroxide is known to yield hydroxyl radicals by a direct process, i.e. with a quantum yield of two OH formed per quantum of radiation absorbed (43):

---

<sup>3</sup> Many applications of the ozone/UV process, including some current commercial reactors, use UV intensities which are extremely high and costly. There is an optimum ratio of UV flux (in Einsteins/min):ozone dose (in moles/min) for each system, but in the absence of much direct photolysis the ratio is probably less than 0.5. In a study of the  $O_3/UV$  oxidation of THM precursors the optimum ratio was 0.3 (18).



Unfortunately, the molar extinction coefficient of hydrogen peroxide at 254 nm is only  $19.6 \text{ M}^{-1} \text{ s}^{-1}$  (43), which is exceptionally low for a primary absorber in a photochemical process. By comparison, the value for ozone is  $3300 \text{ M}^{-1} \text{ cm}^{-1}$ . This means that in order to generate a sufficient level of OH radicals one must have a rather high concentration of hydrogen peroxide in the medium.

Figure 7 shows data from a kinetic study where hydrogen peroxide is being metered into a CSTR at a rate of 10 mg/min while photolyzing the solution with three 13 watt low pressure mercury arc lamps (greater than 90% UV energy at 254 nm). Trichloroethylene, which was spiked into the original solution at approximately 500 ppb, and residual hydrogen peroxide were monitored as the reaction proceeded. Figure 7 shows that TCE is decomposed at a reasonable rate compared to the  $\text{O}_3/\text{H}_2\text{O}_2$  data in Figure 3, but hydrogen peroxide accumulates to unacceptable levels. We conclude that the  $\text{H}_2\text{O}_2/\text{UV}$  is unlikely to be a practical process for drinking water treatment until this problem is solved; however, for wastewater treatment or other purposes it might be useful.

#### SUMMARY OF HYDROXYL RADICAL GENERATING PROCESSES

Table 1 is a summary of the chemistry involved in the generation of hydroxyl radicals from the four processes considered in this review. As noted above, the stoichiometric yield of hydroxyl radicals is greatest from the photolysis of hydrogen peroxide. As Table 2 shows, however, ozone photolysis yields more radicals in practice because of the higher molar extinction coefficient of ozone compared to hydrogen peroxide.

Of the four processes, the  $\text{O}_3/\text{H}_2\text{O}_2$  process should have a high yield of OH radicals, is most amenable to adaptation in existing water treatment plant designs, and should be relatively cost effective. The use of ozone at high pH values may be comparable in cost/effectiveness but there is little field data on this process. The  $\text{O}_3/\text{UV}$  process will be difficult to adopt on a large scale but may be useful for small water and waste water treatment plants, particularly when the substrates of concern are strong UV absorbers.

#### Acknowledgement

The author is grateful to the City of Los Angeles Department of Water and Power for support of this work, partially with funds supplied by the U.S. Environmental Protection Agency through Cooperative Agreement CR-813188, and to E. Marco Aieta, Rhodes Trussell and Carol Tate of James M. Montgomery

Consulting Engineers for useful discussions. The original work was performed by Joon-Wun Kang and Douglas Chapin. This article has not been subjected to review by EPA. Therefore, it does not necessarily reflect the views of the agency, and no official endorsement should be inferred.

#### References

1. M. HORVATH, L. BILITZKY and J. HÜTTNER, Ozone, Elsevier, Amsterdam, 1985.
2. S. LALEZARY, M. PIRBAZARI, and M.J. MCGUIRE, "Oxidation of Five Earthy-Musty Taste and Odor Compounds", Jour.AWWA, 78:3:62(1986).
3. G.R. PEYTON, F.Y. HUANG, J.L. BURLESON and W.H. GLAZE, "Destruction of Pollutants in Water with Ozone in Combination with Ultraviolet Radiation. 1. General Principles and Oxidation of Tetrachloroethylene, Environ. Sci. & Technol. 16:448(1982).
4. J. HOIGNE AND H. BADER, "Rate Constants of Reactions of Ozone with Organic and Inorganic Compounds in Water. I. Non-Dissociating Organic Compounds, Water Research, 17:173(1983).
5. R.L. GARRISON, C.E. MAUK and H.W. PRENGLE, JR., "Advanced Ozone System for Complexed Cyanides", in First International Symposium on Ozone for Water and Wastewater Treatment; R.G. Rice and M.E. Browning, eds., International Ozone Institute, Syracuse, N.Y., 1975, p. 551.
6. H.W. PRENGLE, JR., C.G. HEWES, III AND C.E. MAUK, "Oxidation of Refractory Materials by Ozone with Ultraviolet Radiation, in Second International Symposium on Ozone Technology, R.G. Rice, P. Pichet and M.-A. Vincent, eds., International Ozone Institute, Syracuse, N.Y., 1976, p. 224.
7. H.W. PRENGLE, JR. and C.E. MAUK, "Ozone/UV Oxidation of Pesticides in Aqueous Solution", in Ozone/Chlorine Dioxide Oxidation Products of Organic Materials, R.G. Rice and J.A. Cotruvo, eds., Ozone Press International, Cleveland, OH, 1978, p. 302.
8. H.W. PRENGLE, JR., "Evolution of the Ozone/UV Process for Wastewater Treatment", Presented at IOI/EPA Colloquium on Wastewater Treatment & Disinfection with Ozone, U.S. Environmental Protection Agency, Municipal Environmental Research Laboratory, Cincinnati, OH, Sept. 15, 1977.

9. E. LEITUS, E.H. BRYAN, J.D. ZEFF, D.C. CROSBY and M. SMITH, "An Investigation into the Chemistry of the UV-Ozone Purification Process", Presented at the 4th World Ozone Congress, Houston, Texas, November 27-29, 1979.
10. WESTGATE RESEARCH CORPORATION, "The Continued Investigation into the Chemistry of the UV-Ozone Water Purification Process", Proposal Submitted to National Science Foundation, February 28, 1978; J.D. Zeff, Private Communication.
11. W.H. GLAZE, G.R. PEYTON, F.Y. HUANG, J.L. BURLESON and P.C. JONES, "Oxidation of Water Supply Refractory Species by Ozone and Ultraviolet Radiation", U.S. Environmental Protection Agency, Municipal Environmental Research Laboratory, Cincinnati, OH, EPA-600/2-80-110, August, 1980.
12. W.H. GLAZE, G.R. PEYTON, S. LIN, F.Y. HUANG and J.L. BURLESON, "Destruction of Pollutants in Water with Ozone in Combination with Ultraviolet Radiation. 2. Natural Trihalomethane Precursors, Environ. Sci. & Technol. 16:454(1982).
13. PEYTON, G.R. and W.H. GLAZE, "Mechanism of Photolytic Ozonation", in Photochemistry of Environmental Aquatic Systems, R.G. Zika and W. J. Cooper, eds., ACS Symposium Series 327, Washington, DC, 1986, pp. 76-88.
14. M.K. LEE, G.G. SEE and R.A. WYNVEEN, "Reaction Kinetics of UV/Ozone with Organic Compounds in Hospital Wastewater". Presented at the Symposium on Advanced Ozone Technology, International Ozone Institute, Toronto, ONT, Nov. 16-18, 1977.
15. E.S.K. CHIAN and P.P.K. KUO, "Fundamental Study of the Post Treatment of RO Permeates from Army Wastewaters", Second Annual Summary Report to U.S. Army Medical Research and Development Command, Contract No. DAMD 17-75-C-5506, 1976.
16. P.P.K. KUO, E.S.K. CHIAN and B.J. CHENG, "Identification of Eng Products Resulting from Ozonation of Compounds Commonly Found in Water", in Ozone/Chlorine Dioxide Oxidation Products of Organic Materials, R.G. Rice and J.A. Cotruvo, eds., Ozone Press International, Cleveland, OH, 1978, p. 153.
17. E.G. FOCHTMAN and J.E. HUFF, "Ozone-Ultraviolet Light Treatment of TNT Wastewaters", in Second International Symposium on Ozone Technology, R.G. Rice, P. Pichet and M.-A. Vincent, eds., International Ozone Institute, Syracuse, N.Y., 1976, p. 211.
18. W.H. GLAZE, G.R. PEYTON and B. SOHM, "Pilot Scale Evaluation of Photolytic Ozonation for Trihalomethane Precursor Removal", Report of Cooperative Agreement CR-808825, U.S.

Environmental Protection Agency, Municipal Environmental Research Laboratory, Cincinnati, OH., June, 1984.

19. F.C. FARRELL, J.D. ZEFF, T.C. CRASE and D.T. BOYLAND, "Development Effort to Design and Describe Pink Water Abatement Processes", Final. Technol. Report No 1701 to U.S. Army Armament R&D Command, Dover, NJ, August, 1977.

20. S. NAKAYAMA, K. ESAKI, K. NAMBA, Y. TANIGUCHI, and N. TABATA, "Improved Ozonation in Aqueous Systems", *Ozone Sci. & Engng.* 1:119 (1979).

21. R.A. HANGO, L.J. BOLLYKY and F. DOANE, "Wastewater Treatment for Re-Use in Integrated Circuit Manufacturing", *Wasser-Berlin-81*, 5 *Ozon Weltkongress*, Colloquium Verlag, Berlin, 1981, p. 304.

22. L.J. BOLLYKY, "Pilot Plant Studies for THM, Taste and Odor Control Using Ozone and Ozone-Hydrogen Peroxide", in The Role of Ozone in Water and Wastewater Treatment, Proceedings of the Second International Conference, Edmonton, AL, April 28-29, 1987, p. 211.

23. R. BRUNET, M. M. BOURBIGOT and M. DORE, "Oxidation of Organic Compounds Through the Combination Ozone-Hydrogen Peroxide", *Ozone Sci. & Engng.*, 6: 163 (1984).

24. J.P. DUGUET, E. BRODARD, B. DUSSERT and J. MALLEVIALLE, "Improvement in the Effectiveness of Ozonation of Drinking Water Through the Use of Hydrogen Peroxide", *Ozone Sci. & Engng.*, 7:241 (1985).

25. W.H. GLAZE, J.-W. KANG AND E. M. AIETA, "Ozone-Hydrogen Peroxide Systems for Control of Organics in Municipal Water Supplies", in The Role of Ozone in Water and Wastewater Treatment, Proceedings of the Second International Conference, Edmonton, AL, April 28-29, 1987, p. 233.

26. L. BERGLIND, E. GJESING and E. SKIPPERUD JOHANSEN, "Removal of Organic Matter in Water by UV and Hydrogen Peroxide". In Oxidation Techniques in Drinking Water Treatment, W. Kühn and H. Sontheimer, eds., U. S. Environmental Protection Agency, EPA-570/9-79-020, 1979, pp. 510-523.

27. E. KOUBECK, "Oxidation of Refractory Organics in Aqueous Waste Streams by Hydrogen Peroxide and ultraviolet Light", U.S. Patent Nr. 4, 012, 321 (1977).

28. J. WEISS, "The Radical HO<sub>2</sub> in Solution", *Trans. Faraday Soc.*, 31:668 (1935).

29. J. HOIGNE and H. BADER, "Ozonation of Water: Role of



Hydroxyl Radicals as Oxidizing Intermediates", Science, 109:4216 (1975).

30. J. STAEHELIN and J. HOIGNE, "Decomposition of Ozone in Water: Rate of Initiation by Hydroxide Ion and Hydrogen Peroxide", Environ. Sci. & Technol., 16:676 (1982).

31. R.E. BÜHLER, J. STAEHELIN and J. HOIGNE, "Ozone decomposition in Water Studied by Pulse Radiolysis. 1.  $\text{HO}_2^-/\text{O}_2^-$  and  $\text{HO}_3/\text{O}_3^-$  as Intermediates", J. Phys. Chem., 88:2560 (1984).

32. J. STAEHELIN, R.E. BÜHLER and J. HOIGNE, "Ozone decomposition in Water Studied by Pulse Radiolysis. 2. OH and  $\text{HO}_4$  as Chain Intermediates", J. Phys. Chem., 88:5999 (1984).

33. L. FORNI, D. BAHNEMANN and E.J. HART, "Mechanism of the Hydroxide Ion Initiated Decomposition of Ozone in Aqueous Solution", J. Phys. Chem., 86:255 (1982).

34. K. SEHESTED, J. HOLOMAN, E. BJERGBAKKE and E.J. HART, "Ultraviolet Spectrum and Decay of the Ozonide Ion Radical,  $\text{O}_3^-$ , in Strong Alkaline Solution", J. Phys. Chem., 86:2066 (1982).

35. J. STAEHELIN and J. HOIGNE, "Decomposition of ozone in the Presence of Organic Solutes Acting as Promoters and Inhibitors of Radical Chain Reactions", Environ. Sci. & Technol., 19:1206 (1985).

36. J. HOIGNE and H. BADER, "Ozone Hydroxyl Radical-Induced Oxidations of Organic and Organometallic Trace Impurities in Water", in Organometals and Organometalloids: Occurrence and Fate in the Environment, R. R. Brinckman and J.M. Bellama, eds., ACS Symposium Series 82, American Chemical Society, Washington, DC, (1978), pp. 292-313.

37. J.M. SYMONS et al., "Treatment Techniques for Controlling Trihalomethanes in Drinking Water", U.S. Environmental Protection Agency, Drinking Water Research Division, Cincinnati, OH, EPA-600/2-81-156, September, 1981, pp. 125-128.

38. B. LEGUE, J.P. CROUE, D.A. RECKHOW and M. DORE, "Ozonation of Organic Precursors: Effects of Bicarbonate and Bromide". In Proceedings of the International Conference on The Role of Ozone in Water and Wastewater Treatment, R. Perry and A. E. McIntyre, eds., Selper Ltd, London, (1985), pp. 73-86.

39. H.S. CHRISTENSEN, K. SEHESTED and H. CORFITZAN, "Reactions of Hydroxyl Radicals with Hydrogen Peroxide at Ambient and Elevated Temperatures", J. Phys. Chem., 86:1588 (1982).

40. E. M. AIETA, JAS. M. MONTGOMERY, CONSULTING ENGINEERS,

Pasadena, CA (personal communication).

41. H. OKABE, Photochemistry of Small Molecules, Wiley-Interscience, New York, NY, (1978), p. 244.

42. H. TAUBE, "Photochemical Reactions of Ozone in Solution", *Trans. Faraday Soc.*, 53:656 (1957).

43. J.H. BAXENDALE and J.A. WILSON, "The Photolysis of Hydrogen Peroxide at High Light Intensities", *Trans. Faraday Soc.*, 53:344 (1957).

44. A. L. LAZRUS, G.L.KOK, S.N. GITLIN, J.A. LIND and S.E. MCLAREN, "Automated Fluorometric Method for Hydrogen Peroxide in Atmospheric Precipitation", *Anal. Chem.*, 57:917-922 (1985)

## LEGEND OF FIGURES

FIGURE 1. Scheme showing the principal species in the decomposition of ozone in pure water initiated by hydroxide ions (after Staehelin et al., reference 32).

FIGURE 2. Effect of pH on the ozonation of trichloroethylene (TCE) in North Hollywood Well No. 26 water. Bicarbonate alkalinity: 200 mg/L; TOC 1.1 mg/L; pH adjusted upwards with sodium hydroxide, downward with hydrochloric acid; 70 liter CSTR with ozone from pure oxygen.

FIGURE 3. Effect of hydrogen peroxide on the pseudo first-order rate constants of oxidation of TCE in North Hollywood Well No. 14 water. Alkalinity: 300 mg/L; 70 liter CSTR with ozone from pure oxygen, O<sub>3</sub> scale is dose rate, utilization > 90%.

FIGURE 4. Effect of ozone and UV dose rates on the photolytic ozonation of perchloroethylene (PCE) in North Hollywood Well No. 14 water. Rate constants (s<sup>-1</sup>) multiplied by 10<sup>4</sup>; UV dose in watts/L at 254 nm calibrated by chemical actinometry.

FIGURE 5. Effect of ozone and UV dose rates on the photolytic ozonation of trichloroethylene (TCE) in North Hollywood Well No. 14 water. Rate constants (s<sup>-1</sup>) multiplied by 10<sup>4</sup>; UV dose in watts/L calibrated by chemical actinometry.

FIGURE 6. Schematic diagram of the elements of mass and photon transfer, and chemical processes involved in the O<sub>3</sub>/UV process.

FIGURE 7. Pseudo first-order plot for destruction of TCE by H<sub>2</sub>O<sub>2</sub>/UV process in North Hollywood Well No. 14 water. Reaction carried out in 70 liter CSTR with feed rate of 10 mg H<sub>2</sub>O<sub>2</sub> per minute. Residual peroxide by horseradish peroxidase fluorimetry (44).

TABLE 1

THEORETICAL AMOUNTS OF OXIDANTS AND UV  
 REQUIRED FOR FORMATION OF HYDROXYL  
 RADICAL IN OZONE-PEROXIDE-UV SYSTEMS

SYSTEM	Moles of Oxidant Consumed per Mole of OH Formed		
	O <sub>3</sub>	UV <sup>1</sup>	H <sub>2</sub> O <sub>2</sub>
OZONE-HYDROXIDE ION <sup>3</sup>	1.5	--	--
OZONE-UV	1.5	0.5	(0.5) <sup>2</sup>
OZONE-HYDROGEN PEROXIDE <sup>3</sup>	1.0	--	0.5

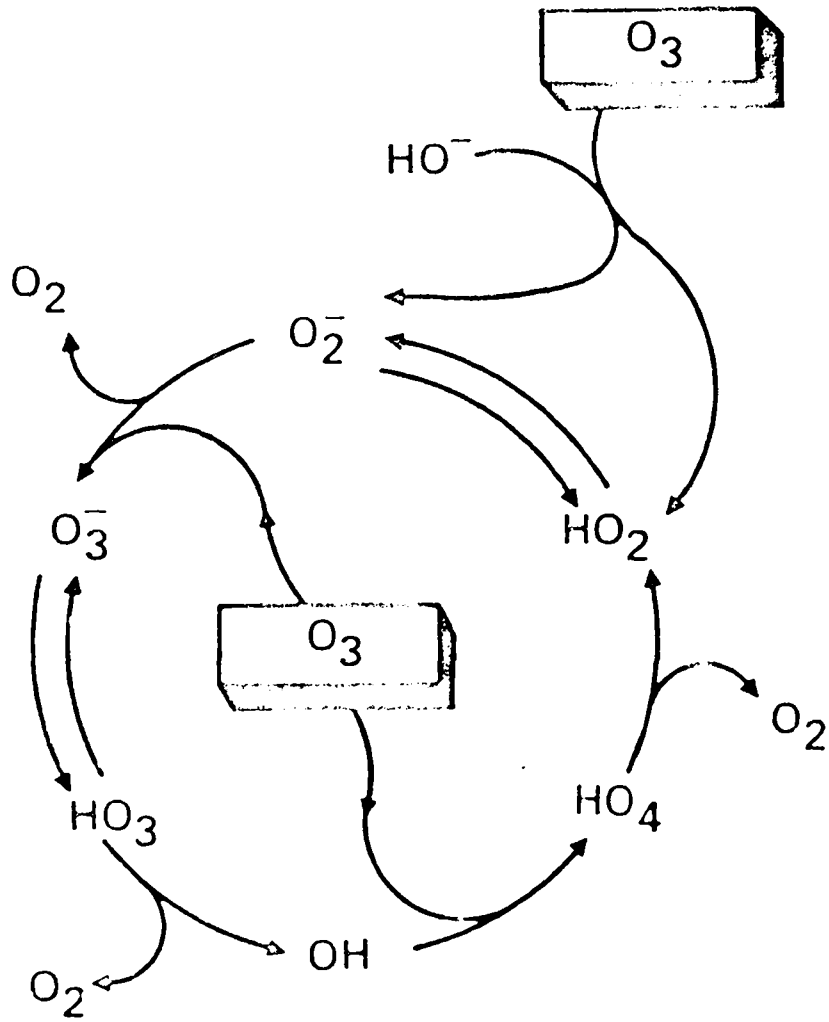
<sup>1</sup>Moles of photons (Einsteins) required for each mole of OH formed; <sup>2</sup>Hydrogen peroxide formed in situ (13,42); <sup>3</sup> Assumes that superoxide formed in primary step yields one OH radical per O<sub>2</sub><sup>-</sup> which may not be the case in certain waters.

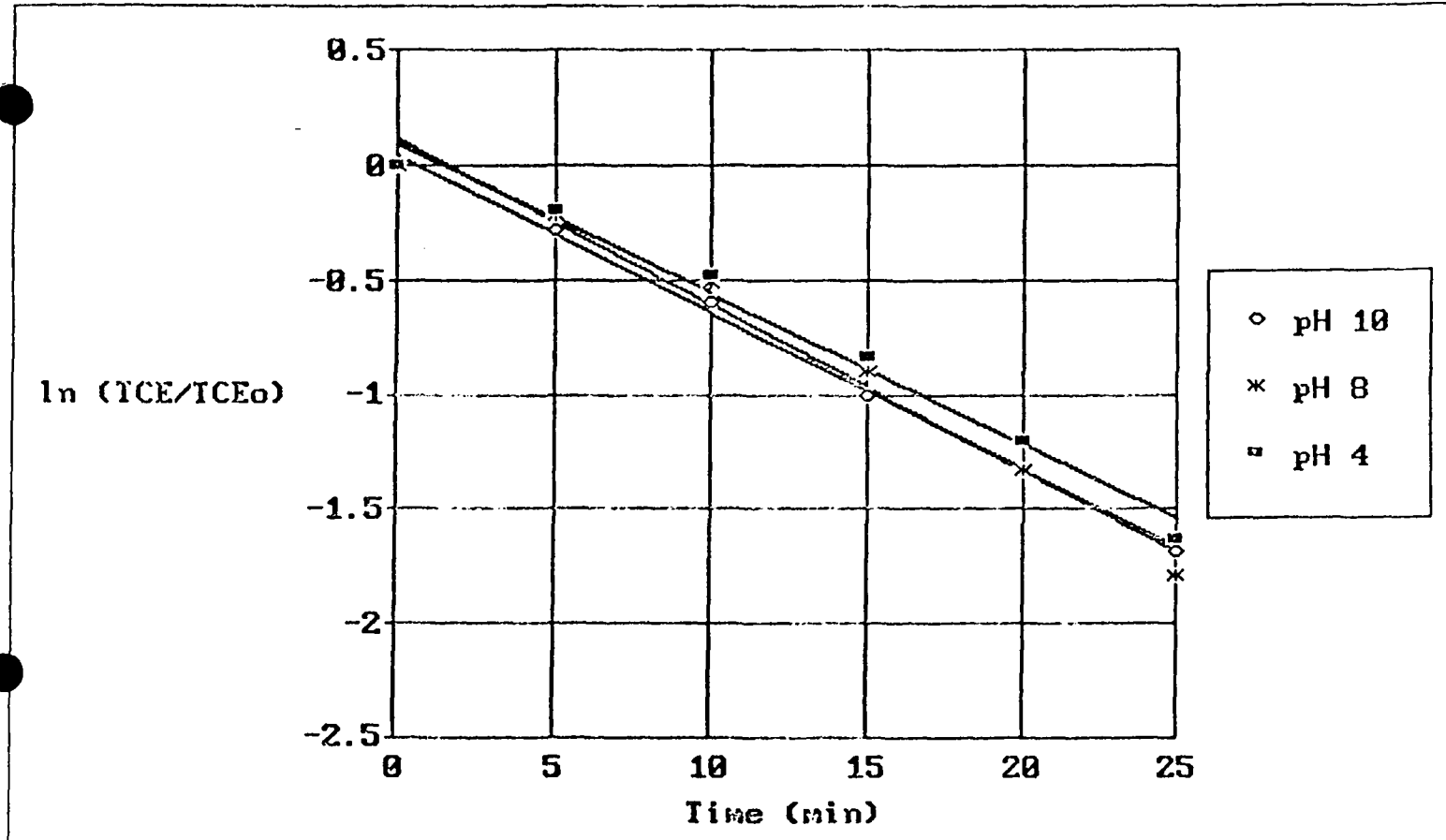
TABLE 2

THEORETICAL FORMATION OF HYDROXYL RADICALS FROM  
PHOTOLYSIS OF OZONE AND HYDROGEN PEROXIDE

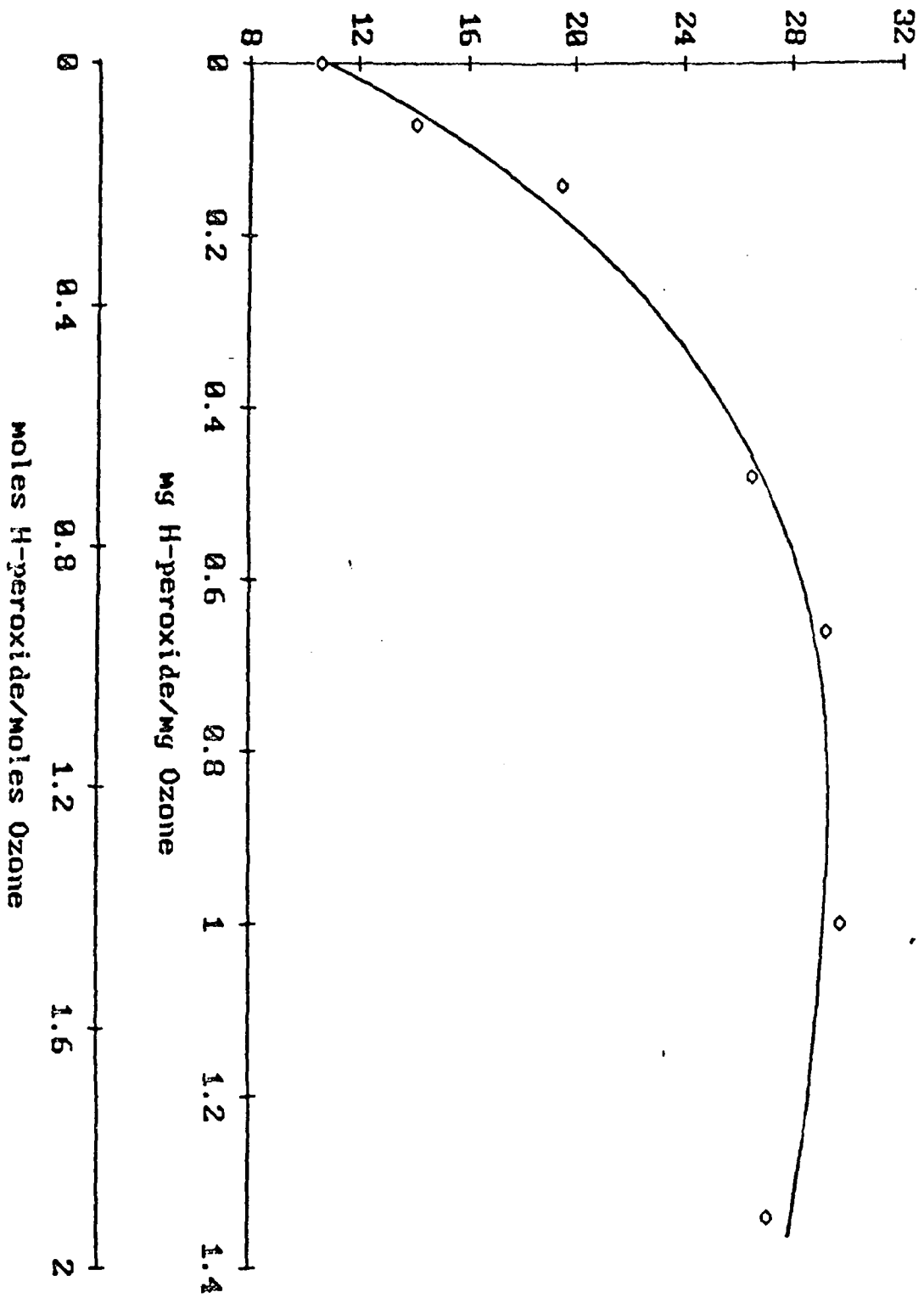
	MOLAR ABSORBTIVITY 254 ( $M^{-1} \text{ cm}^{-1}$ )	STOICHIOMETRY	OH RADICALS FORMED <sup>1</sup> PER INCIDENT PHOTON
$H_2O_2$	20	$H_2O_2 \text{ ----> } 2OH$	0.09
$O_3$	3300	$3O_3 \text{ -----> } 2OH$	2.00

<sup>1</sup> Assumes 10 cm pathlength; quantum yield as predicted from stoichiometry;  $[O_3]$  and  $[H_2O_2]$  at  $1 \times 10^{-4}$  M.



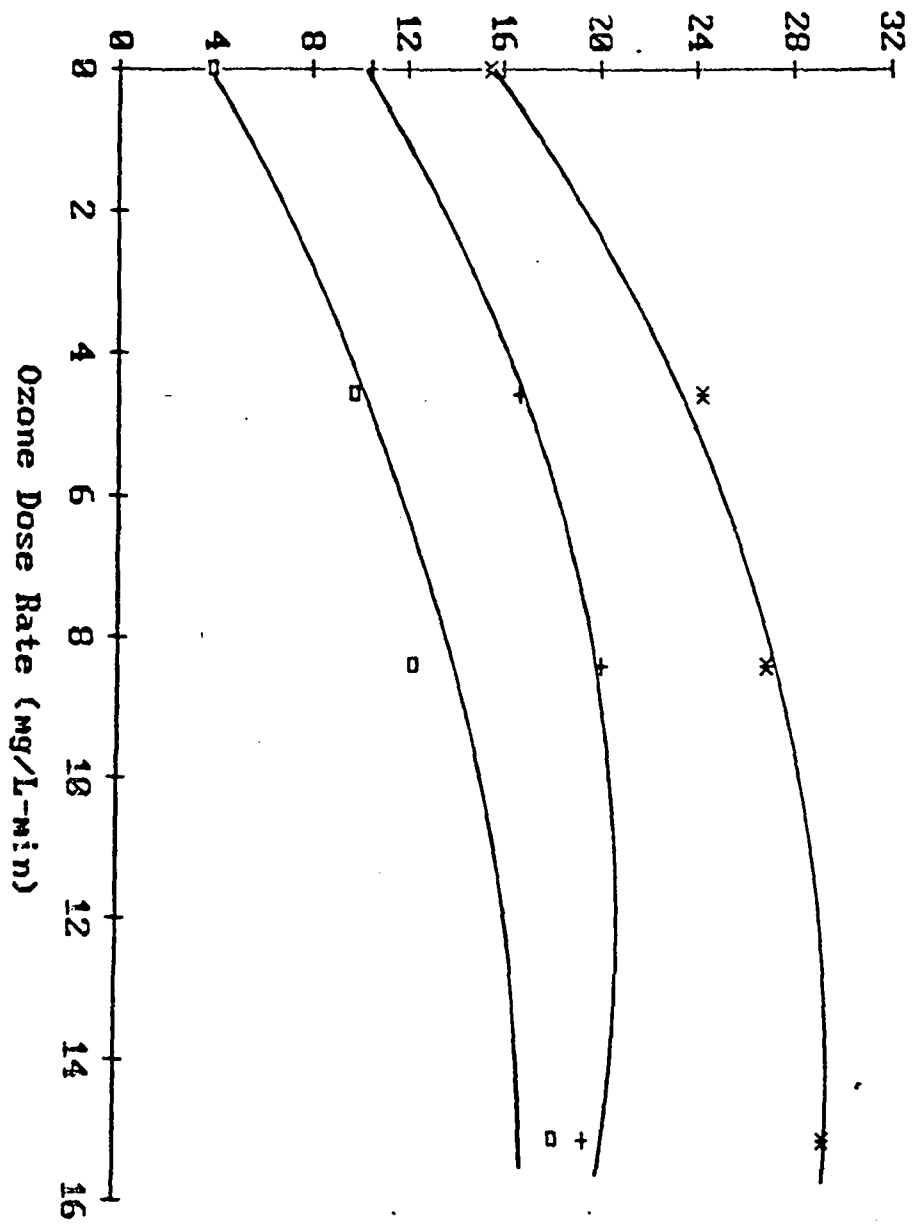


Pseudo First Order Rate Constant  $\times 10^4$  (4)



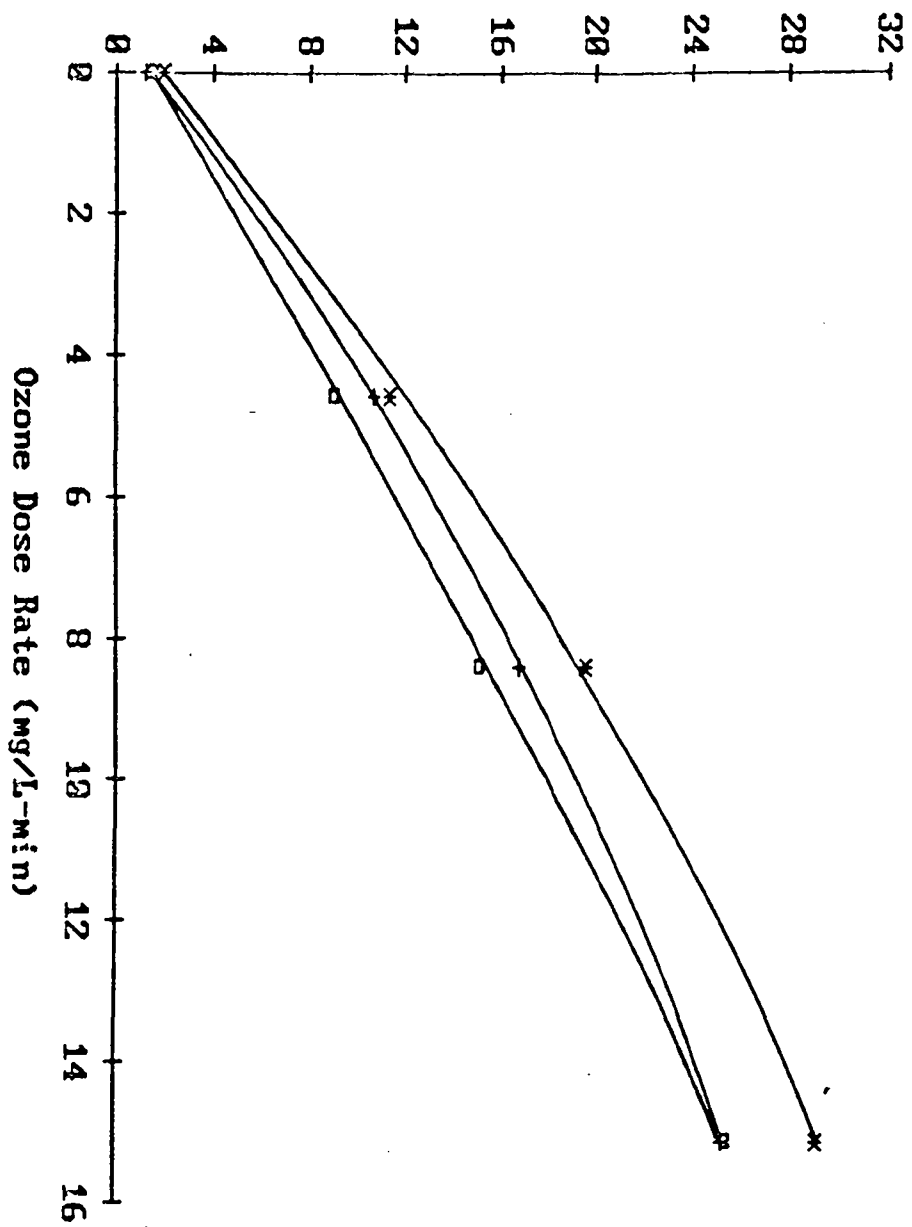


Pseudo First Order Rate Constant x 10 (4)



□ 0.19 M/L  
+ 0.38 M/L  
\* 0.57 M/L

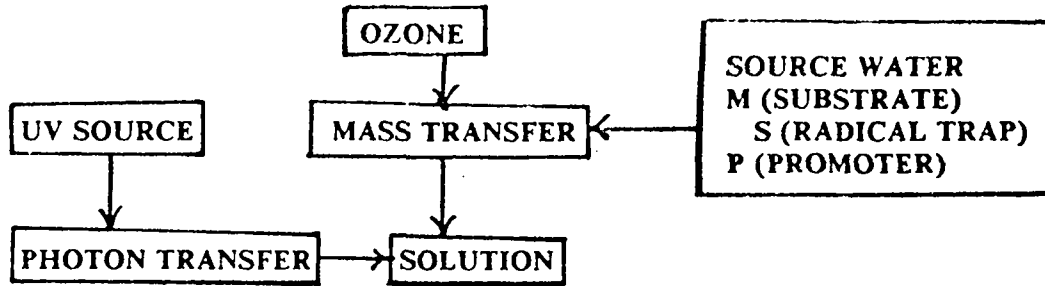
Pseudo First Order Rate Constant  $\times 10$  (4)



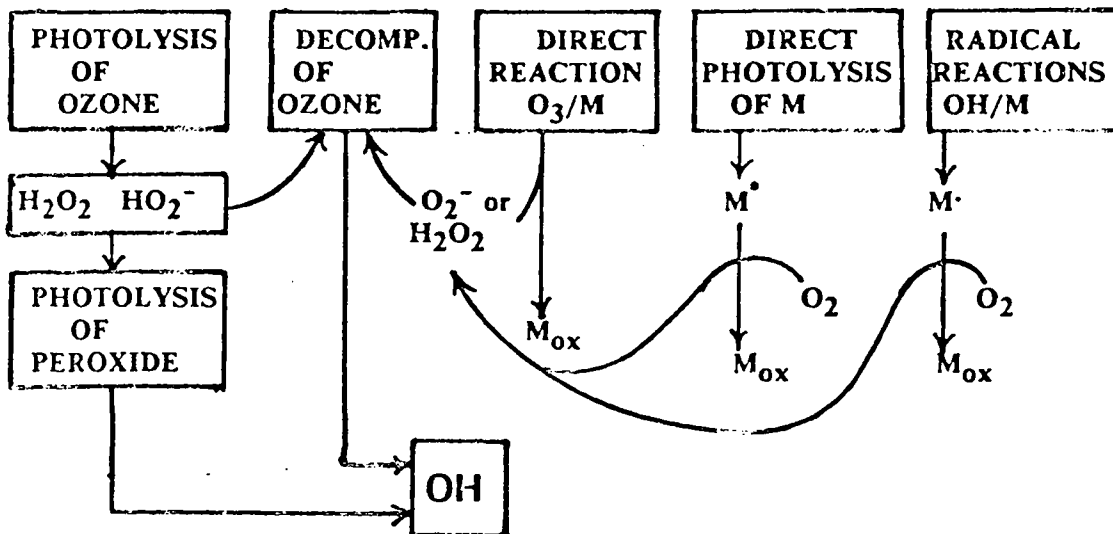
□ 0.19 M/L  
+ 0.38 M/L  
\* 0.57 M/L

# ELEMENTS OF THE OZONE/ULTRAVIOLET RADIATION PROCESS

## MASS TRANSFER AND PHOTON TRANSFER



## CHEMICAL PROCESSES



Effect of Oxidizer Product<sup>a</sup> on Survival of Microorganisms

Expt. no.	Test microbe	Oxidizer concentration (ppm)	Time between oxidizer production and use	Concentration of exposed microbe/ml	Time of exposure to oxidants	Concentration of surviving microbe/ml
1	<u>Pseudomonas aeruginosa</u>	17	5 min.	10 <sup>7</sup>	60 min.	10 <sup>0</sup>
	<u>Pseudomonas aeruginosa</u>	1.7	5 min.	10 <sup>7</sup>	60 min.	10 <sup>0</sup>
	<u>Pseudomonas aeruginosa</u>	17	5 min.	10 <sup>7</sup>	24 hr.	10 <sup>0</sup>
	<u>Pseudomonas aeruginosa</u>	1.7	5 min.	10 <sup>7</sup>	24 hr.	10 <sup>0</sup>
2	<u>Pseudomonas aeruginosa</u>	1.5	5 min.	10 <sup>6</sup>	60 min.	10 <sup>0</sup>
	<u>Pseudomonas aeruginosa</u>	4	5 min.	10 <sup>6</sup>	60 min.	10 <sup>0</sup>
	<u>Pseudomonas aeruginosa</u>	4	5 min.	10 <sup>6</sup>	10 min.	10 <sup>0</sup>
	<u>Pseudomonas aeruginosa</u>	4	24 hr.	10 <sup>6</sup>	60 min.	10 <sup>0</sup>
	<u>Pseudomonas aeruginosa</u>	4	24 hr.	10 <sup>6</sup>	10 min.	10 <sup>0</sup>
	<u>Legionella pneumophila serogroup 1</u>	4	5 min.	10 <sup>7</sup>	60 min.	10 <sup>0</sup>
3	<u>Naegleria fowleri</u>	40	5 min.	10 <sup>2</sup>	60 min.	10 <sup>0</sup>
	<u>cysts</u>					

<sup>a</sup> A current of 7 amps (5-7 volts) and a water flow rate of 1.2 gpm was used.

ING. FRED M. REIFF  
 DIVISION DE PROTECCIÓN DE LA SALUD AMBIENTAL

Effect of Oxidizer Product<sup>a</sup> on Survival of Microorganisms

Expt. no.	Test microbe	Oxidizer concentration (ppm)	Time between oxidizer production and use	Concentration of exposed microbe/ml	Time of exposure to oxidants	Concentration of surviving microbe/ml
1	<u>Pseudomonas aeruginosa</u>	17	5 min.	10 <sup>7</sup>	60 min.	10 <sup>0</sup>
	<u>Pseudomonas aeruginosa</u>	1.7	5 min.	10 <sup>7</sup>	60 min.	10 <sup>0</sup>
	<u>Pseudomonas aeruginosa</u>	17	5 min.	10 <sup>7</sup>	24 hr.	10 <sup>0</sup>
	<u>Pseudomonas aeruginosa</u>	1.7	5 min.	10 <sup>7</sup>	24 hr.	10 <sup>0</sup>
	<u>Pseudomonas aeruginosa</u>	1.5	5 min.	10 <sup>6</sup>	60 min.	10 <sup>0</sup>
2	<u>Pseudomonas aeruginosa</u>	4	5 min.	10 <sup>6</sup>	60 min.	10 <sup>0</sup>
	<u>Pseudomonas aeruginosa</u>	4	5 min.	10 <sup>6</sup>	10 min.	10 <sup>0</sup>
	<u>Pseudomonas aeruginosa</u>	4	24 hr.	10 <sup>6</sup>	60 min.	10 <sup>0</sup>
	<u>Pseudomonas aeruginosa</u>	4	24 hr.	10 <sup>6</sup>	10 min.	10 <sup>0</sup>
3	<u>Legionella pneumophila serogroup 1</u>	4	5 min.	10 <sup>7</sup>	60 min.	10 <sup>0</sup>
	<u>Naegleria fowleri</u> cysts	40	5 min.	10 <sup>2</sup>	60 min.	10 <sup>0</sup>

<sup>a</sup> A current of 7 amps (5-7 volts) and a water flow rate of 1.2 gpm was used.

ADVANCED OXIDATION PROCESSES FOR TREATMENT OF GROUNDWATER  
CONTAMINATED WITH TRICHLOROETHYLENE AND TETRACHLOROETHYLENE:  
LABORATORY STUDIES

William H. Glaze and Joon-Wun Kang, Environmental Science & Engineering Program, School of Public Health, UCLA, Los Angeles, California 90024

ABSTRACT

The oxidation of trichloroethylene (TCE) and tetrachloroethylene (or perchloroethylene - PCE) was studied in a stirred sparged reactor with various dose rates of ozone and hydrogen peroxide. The results show that hydrogen peroxide accelerates the oxidation of TCE and PCE spiked into a ground water taken near Los Angeles, California. At peroxide:ozone dose rates above 0.7 (w/w) the process appears to be mass transfer limited. The presence of high levels of bicarbonate ion in the groundwater is shown to significantly lower the efficiency of TCE and PCE removal by the  $O_3/H_2O_2$  process suggesting that softening prior to oxidation may improve the process even further.

INTRODUCTION

Groundwater contamination by trichloroethylene (TCE), tetrachloroethylene (PCE), and other industrial and agricultural chemicals is now a matter of international concern. The U.S.E.P.A. recently proposed Maximum Contaminant levels for TCE and seven other contaminants in drinking water and a standard for PCE may be forthcoming (1). In accordance with the Safe Drinking Water mandate, EPA also specified two technologies as Best Available Technology (BAT) for treatment

of water containing these substances: air stripping and granular activated carbon filtration. Some have objected to these technologies on the basis that they merely transfer the problem from one medium (water) to another (air or GAC).

Oxidation processes offer the option, at least in principle, of completely destroying organic contaminants. Of the oxidants currently available, ozone is attracting the most attention. This is due to its high thermodynamic oxidation potential (2.07 volts) and the apparent lack of hazardous by-products (2). However, neither ozone nor any other oxidant has proven itself as a BAT process for removing synthetic organic compounds from ground water. To overcome this deficiency and to enhance its effectiveness for oxidation of organics, modifications of traditional ozonation have been investigated in our bench-scale laboratory tests.

Each of the processes studied, which we refer to as advanced oxidation processes (3,4), involve the generation of the hydroxyl radical (OH), a very active intermediate which generally has far greater oxidizing power than ozone. Rate constants for reaction of OH with organic species are commonly in the range of  $10^9$ - $10^{10}$  M<sup>-1</sup>s<sup>-1</sup> (5).

Four types of advanced oxidation processes are being studied. These include: ozone at various pH values (O<sub>3</sub>/pH), ozone with

hydrogen peroxide ( $O_3/H_2O_2$ ), ozone with ultraviolet radiation ( $O_3/UV$ ), and hydrogen peroxide with ultraviolet radiation ( $H_2O_2/UV$ ). This paper describes an evaluation of the first two processes ( $O_3/pH$  and  $O_3/H_2O_2$ ) for the oxidation of TCE and PCE in a contaminated groundwater obtained from two City of Los Angeles Department of Water and Power (LADWP) North Hollywood wells. The results, combined with pilot-scale studies described in the following paper (6), show that the ozone:hydrogen peroxide process should be considered as a candidate for Best Available Technology for TCE/PCE treatment.

#### EXPERIMENTAL

Reaction apparatus. Figure 1 shows the schematic diagram of the  $O_3/H_2O_2/UV$  experimental system. Ozone was generated from oxygen with a single tube OREC generator (corona discharge type), typically at a flow rate of 1.0 L/min and at a tube current setting so as to give a desired dose rate. Control panel valves (needle, 3-way, and 5-way valve) allowed one to divert the ozone stream through two tandem bubblers for ozone analysis or alternately divert the ozone off-gas from the reactor through the same bubblers. When the analysis system is not in use, ozone off-gas is thermally decomposed before exit into a vented hood. All fittings, valves, and tubing were limited to stainless steel, glass, and teflon. The reactor used in these studies is a cylindrical 70 liter (liquid volume) CSTR designed according to the principles



described by Yocum (7). The reactor is a 36 inch high by 13 inch O.D. stainless steel vessel with a built-in sparger for ozone introduction, a variable speed stirrer (usually operated at 500 rpm), internal baffles at the quadrants to facilitate mixing, and four 2-inch diameter symmetrically located circular ports into each of which can be fitted a quartz tube for a UV lamp. The UV ports were sealed off with stainless steel plates in this study.

Test Samples. Groundwater used for all of the  $O_3/H_2O_2$  runs, except to study the effect of bicarbonate alkalinity, was collected from the City of Los Angeles Department of Water and Power North Hollywood Well No. 14 or Well No. 26. The water was transported to UCLA in a 55-gallon polyethylene drum. Typical analysis of the groundwater, for Well No. 14 or 26 respectively, was: alkalinity, 300 mg/L and 200 mg/L (as  $CaCO_3$ ), respectively; pH 7.2-7.4; TCE and PCE, 50 and 5 ug/L, respectively; and TOC 1.1 mg/L.

Analytical methods. Ozone is analyzed in the gas phase by trapping in an borate-buffered potassium iodide solution (8). The concentration of resulting iodine is determined colorimetrically at 352 nm on a Spectronic 710 spectrophotometer (Bausch & Lomb, Rochester, N.Y), which is previously calibrated by standard iodine solution. Ozone in the liquid phase is determined by the indigo method (9). Each ozone

sample was added to a 40 ml vial which contained an appropriate concentration of potassium indigo trisulfonate stock reagent depending on the concentration of ozone expected. The absorbance difference between sample and blank was measured at 600 nm. An extinction coefficient of 20,000 L Mol<sup>-1</sup> cm<sup>-1</sup> (9) was used for calculation of the concentration of residual ozone. Concentration of residual hydrogen peroxide was determined either by the cobalt method of Masschelein (10) or the horseradish peroxidase-catalyzed fluorescence method described by Lazrus, et al. (11). Hydrogen peroxide feeding solution (usually 0.12 N) was prepared from a reagent grade 30% stock solution (Fisher Scientific) and was analyzed by the AOAC Method (12). A method for analysis of TCE and PCE modified from EPA Method 501.2 consisted of microscale liquid-liquid extraction using pentane or hexane (American Burdic & Jackson brand for THM analysis) with a water to extractant volume ratio of 2:1. Two different gas chromatograph (GC) models were used for TCE/PCE analysis. Most of the analytical work was performed on a Varian 3700 GC with Ni<sup>63</sup> electron capture detector (ECD), a glass column (12' x 1/4" O.D., 10% squalane), and a 5% methane and 90% argon gas mixture as carrier gas. A Shimadzu Chromatopac C-R3A electronic/printer integrator was connected to the Varian GC to collect data and compute sample concentrations. Later sample analyses were carried out on a Perkin-Elmer Model 8500 GC using splitless injection and a

Ni<sup>63</sup> ECD. A fused silica wall coated open tubular column (DB-5, 30 m x 0.32 mm I.D.) supplied by J&W Scientific was used. Oven temperature was programmed from 40°C to 220°C at 10°C/min. Helium gas (99.995%) and 5% methane/95% argon gas mixture were used for carrier and make-up gas, respectively. Hexane was used as extractant for this splitless injection mode to optimize the solvent effect. The internal standard used for all GC analyses was 1,2-dibromopropane (DBP). Quality control features of EPA Method 501.2 were used for preparation of calibration standards for the extraction method.

Procedures. For each run, groundwater was pumped into the CSTR and filled up to a guide level of 70 L. Saturated solutions of TCE and PCE were prepared separately by stirring pure compounds in contact with distilled water. After analysis, these stock solutions were used to prepare aqueous solutions of known concentrations of TCE and PCE that were spiked into the reactor so as to give target initial TCE and PCE concentrations of approximately 500 and 50 ug/L, respectively. After a few minutes of mixing, oxygen gas was introduced into the CSTR at a desired flow rate. To detect any system leaks, another rotameter was installed at the gas stream exit. Flow rate of the exit stream was then compared to the inlet flow rate. At time zero, ozone generation was started using pre-set conditions for the ozone generator. If

hydrogen peroxide was included in the run, it was added simultaneously with the ozone using a calibrated feed pump supplied by Mec-O-Matic Company. For some runs, the pH of the groundwater sample was adjusted prior to oxidation using either a NaOH solution or H<sub>2</sub>SO<sub>4</sub> solution.

Duplicate samples of the CSTR contents were taken for TCE and PCE analysis at five-minute intervals, beginning at time zero and ending 25 minutes later. Two drops of 1% sodium thiosulfate were present in each 40 ml vial before the groundwater samples were added. The vials were filled head-space free and sealed with screw caps with PTFE-coated liners. Samples were stored in a refrigerator (organic free) at 4°C prior to extraction. Samples were taken at the same time intervals to measure concentrations of residual ozone and hydrogen peroxide as described above. Ozone off-gas was trapped in the BKI-contained bubbler and the amount of ozone consumed in the reactor was calculated from the concentration of ozone in the feed gas and the concentration of ozone in off-gas.

Measurement of Ozone Mass Transfer for CSTR. The reactor was filled with water taken from North Hollywood well No. 14 and ozone flow started at the same flow rate as before (1.0 L-min<sup>-1</sup>). Samples were withdrawn sequentially from the reactor and quenched with a solution of indigo trisulfonate, then the absorbance of the solution was measured as usual.

## RESULTS & DISCUSSION

### Ozone system.

Hoigné and Bader have reported that the rate constants for direct reaction of ozone with TCE and PCE are  $17 \pm 4 \text{ M}^{-1} \text{ s}^{-1}$  and  $<0.1 \text{ M}^{-1} \text{ s}^{-1}$  respectively (13). This means that a steady state concentration of 5 mg/L ( $1 \times 10^{-4} \text{ M}$ ) of ozone would be required for 95% oxidation of TCE within a thirty minute contact time, assuming pseudo first order kinetics. For PCE the rate is expected to be at least an order of magnitude slower. It might be concluded, therefore, that direct reaction of ozone will not be sufficiently rapid to be a practical decontamination method for PCE but for TCE it may be worth exploring.

It is now recognized, however, that calculations based on such basic rate data are of little value in determining the prospects of using ozone for water treatment objectives (14). Few ozonation processes occurring in a natural water occur only by direct reaction of ozone with the substrate of interest. In natural waters ozone reacts by two mechanisms: direct reaction of the  $\text{O}_3$  molecule, for example, by addition of  $\text{O}_3$  to the carbon-carbon double bond of TCE or PCE, and reaction with the hydroxyl radical, formed by the decomposition of ozone (14). Both types of reactions are expected to occur in natural waters where there are naturally occurring

electron transfer agents present (or formed during ozonations) that initiate ozone decomposition, such as  $\text{OH}^-$ , transition metal ions, hydrogen peroxide, superoxide, etc. (Figure 2). Also, most common water impurities such as bicarbonate, carbonate, and organic material react with  $\text{OH}$  radicals and act as scavengers, and some react with molecular ozone. Thus, the relative importance of direct vs. radical reactions must be determined experimentally for each source water.

Table 1 is a summary of pseudo first order rate constants for the ozone runs performed on groundwater samples from the North Hollywood Well No. 26 spiked with 500 and 50  $\mu\text{g L}^{-1}$  of TCE and PCE respectively. The initial alkalinity of the source water is 200  $\text{mg/L}$  (as  $\text{CaCO}_3$ ) and the TOC value is 1.1  $\text{mg/L}$ . Figure 3 is a plot of typical runs for TCE, showing the pseudo first order nature of the process.

It is interesting to note that increasing pH from 4 to 10 has little effect on the destruction of TCE as shown by the data in Table 1. This may be due to the important role played by the bicarbonate ion in the water, which can have both positive and negative effects on the rate of substrate oxidation. Bicarbonate and carbonate ions react with  $\text{OH}$  by electron transfer reactions (10) and (11) shown in Table 2.

Since the rate constant of OH radicals reacting with carbonate ions is far greater than that with bicarbonate ions, increasing the pH of the medium will be expected to decrease the efficiency of OH trapping by TCE or PCE. On the other hand, increasing pH values will accelerate the decomposition process which produces more hydroxyl radicals (Figure 2 and equation 6).

Apparently, the competing effects noted above essentially cancel each other and there is no practical advantage to increasing the pH when TCE destruction is the desired result. It should be noted, however, that this conclusion may not apply to all substrates and test waters, especially those which are low in alkalinity and higher in natural promoting agents.

#### Ozone/H<sub>2</sub>O<sub>2</sub> System.

According to the works of Hoigné et al (15-17) and Hart et al (18-19), hydrogen peroxide can initiate the decomposition of ozone by a single electron transfer process wherein the initiating species is the hydroperoxide ion HO<sub>2</sub><sup>-</sup> (reaction 1, Table 2). The products of this reaction are the ozonide ion O<sub>3</sub><sup>-</sup> and the hydroperoxide radical HO<sub>2</sub>, each of which can form OH radicals by the pathways shown in Table 2. From the rate constants for equations (1) and (6) it can be shown that

initiation by peroxide is much faster than by hydroxide ion when the former is present in the millimolar range (15).

Using a steady state approximation for the various intermediates shown in Table 2 the following equation for the steady state concentration of OH may be derived:

$$[\text{OH}] = \frac{2k_1K_{\text{PER}} [\text{H}_2\text{O}_2][\text{O}_3]/[\text{H}^+]}{k_{\text{M}}[\text{M}] + \sum_i k_i[\text{S}_i]} \quad (13)$$

where the constants are defined in Table 2, M is the substrate (TCE or PCE), and S<sub>i</sub> refers to the various substances in the water which act as scavengers of OH radicals. The "2" in equation (13) symbolizes the fact that two OH radicals are formed from each initiation step (equation 1), one from the O<sub>3</sub><sup>-</sup> ion and one from the HO<sub>2</sub> radical.

The rate of TCE or PCE oxidation is given by the expression

$$-d(\ln M)/dt = k_0 = k_{\text{M,OH}}[\text{OH}] + k_{\text{M,O}_3}[\text{O}_3], \quad (14)$$

where k<sub>M,OH</sub> and k<sub>M,O<sub>3</sub></sub> refer to rate constants for reaction of the substrate with OH radicals and ozone respectively, and k<sub>0</sub> is the observed pseudo first order rate constant for overall oxidation of M. Under conditions where the direct reaction of M with O<sub>3</sub> is negligible, the last equation may be combined with equation (13) to yield equation (15):



$$k_o = \frac{k_{M,OH}^2 k_1 K_{PER} [H_2O_2][O_3]/[H^+]}{k_M[M] + \sum_i k_i[S_i]} \quad (15)$$

In hard ground water the principal scavengers  $S_i$  will be bicarbonate ions that are present in relatively high concentration compared to the pollutant substrate  $M$ ; then equation (15) will reduce to equation (16):

$$k_o = \frac{k_{M,OH}^2 k_1 K_{PER} [H_2O_2][O_3]/[H^+]}{k_{HCO_3} [HCO_3^-]} \quad (16)$$

Equation (16) states that the psuedo first-order rate constant for the OH radical oxidation of a substrate in the  $O_3/H_2O_2$  process should be proportional to the liquid phase concentrations of ozone and peroxide, and inversely proportional to bicarbonate and hydrogen ion concentrations.

In a CSTR, the level of ozone present in solution  $[O_3]$  is determined by the rate of transfer from the gas to the liquid phase minus the ozone lost to decomposition and reaction:

$$(d[O_3]/dt)_t = k_1^* a (P/H - [O_3]) - \sum_j k_j [S_j] [O_3] \quad (17)$$

where  $\sum_j S_j$  refers to all of the species that consume ozone,  $k_1^* a$  is the overall mass transfer coefficient,  $P$  is the partial pressure of ozone in the gas phase and  $H$  is the Henry's Law constant for ozone in water ( $82 \text{ atm-L-mole}^{-1}$ ).

If we assume that the major reactions consuming ozone are equations 1 and 2 (Table 2), then equation (17) reduces to equation (18):

$$(d[O_3]/dt)_t = k_1^*a(P/H - [O_3]) - 2k_1K_{PER}[H_2O_2][O_3]/[H^+] \quad (18)$$

When the rate of transfer has reached a steady state, the ozone concentration in the liquid phase is given by equation (19), obtained by setting equation (18) to zero:

$$[O_3] = \frac{k_1^*a(P/H)}{k_1^*a + 2k_1K_{PER}[H_2O_2]/[H^+]} \quad (19)$$

This expression for residual ozone can then be plugged into equation (16) to give equation (20):

$$k_o = \frac{k_{M,OH}2k_1K_{PER}[H_2O_2]/[H^+]}{k_{HCO_3}[HCO_3^-]} \cdot \frac{k_1^*a(P/H)}{k_1^*a + 2k_1K_{PER}[H_2O_2]/[H^+]} \quad (20)$$

When the reaction conditions are such that the term  $2k_1K_{PER}[H_2O_2]/[H^+]$  is much greater than  $k_1^*a$ , as when peroxide levels are high, then equation (20) reduces to equation (21):

$$k_o = \frac{(k_{M,OH})(k_1^*a)(P/H)}{k_{HCO_3}[HCO_3^-]} \quad (21)$$

that is, the value of  $k_o$  will be proportional to the mass transfer coefficient, the partial pressure of ozone in the gas phase and the rate constant for reaction of OH radicals with the substrate M. When peroxide levels are low, equation

(20) reduces to equation (22):

$$k_o = \frac{k_{M,OH}^2 k_1 K_{PER} [H_2O_2] / [H^+] (P/H)}{k_{HCO_3} [HCO_3^-]} \quad (22)$$

which states that  $k_o$  should be a linear function of peroxide dose. In both cases,  $k_o$  will be inversely proportional to bicarbonate levels, the assumed principal scavenger.

The experimental data in Figures 4 and 5 show that hydrogen peroxide has a significant accelerating effect on the rate of oxidation of TCE and PCE. Pseudo-first order rate constants for the oxidation of TCE and PCE at various ozone and peroxide dose rates are shown in Table 3. In Figure 6 the values of the rate constants at an ozone dose of 15  $\mu\text{g}/\text{min}$  are plotted versus the ratio of peroxide to ozone dose. The shape of the curve is precisely that which is predicted by equation (20) as discussed above.<sup>1</sup>

The data in Table 3 show that the addition of hydrogen peroxide causes a maximum rate enhancement for TCE oxidation by a factor of about 1.8 to 2.8, depending on the ozone dose rate. PCE rates are enhanced much more dramatically, from

---

<sup>1</sup> There is another possible explanation of the shape of Figure 6, namely, that superoxide  $O_2^-$  does not enter into subsequent OH formation by equation (5), i.e. in excess concentration hydrogen peroxide quenches OH radicals by equations 7 and 8 without contributing to the pool of OH precursors (4). There is little reason to suspect that this is the case but it is a possibility that cannot be discarded.

2.0 to 6.5 fold. This is apparently due to the fact PCE reacts primarily by a radical mechanism whereas TCE reacts both by direct reaction with  $O_3$  and by the radical mechanism.<sup>2</sup> When OH radical chemistry is dominant, the ratio of the rate constants for TCE and PCE oxidation should be equal to the ratio of their rate constants with OH radicals:

$$k_{O,TCE}/k_{O,PCE} = k_{5a}/k_{5b} = 1.7 \quad (23)$$

Inspection of Table 3 will show that the ratio of pseudo first order rate constants is close to this value when the ratio of  $H_2O_2$  to  $O_3$  is near unity and when the ozone dose rate is relatively low (4.5 mg/min).

#### Effects of Bicarbonate on $O_3$ and $O_3/H_2O_2$ oxidations.

There is a significant amount of bicarbonate in the ground water tested, which should trap OH radicals and interfere

---

<sup>2</sup> The ratio of the pseudo first order rates constants  $k_{O,TCE}/k_{O,PCE}$  when no peroxide was added are not constant (Table 3). This is probably due to the fact that pure  $O_3$  chemistry is never observed in a natural water, and especially at low ozone doses there is a mixture of direct  $O_3$  and OH radical chemistry. Only when there are no natural promoters can the ratio approach the value for the direct reaction, which according to Hoigné and Bader should be greater than 170 (13). Since the ratio for reaction with OH radicals is only 1.7 the observed values with no added peroxide are evidence of mixed chemistry.

with the destruction of target compounds such as TCE and PCE. The OH radical is far more reactive with TCE than with the bicarbonate ion, as shown in Table 2; however, the molarity of the bicarbonate ion ( $6.0 \times 10^{-3}$  M at 300 mg/L as  $\text{CaCO}_3$ ) is much greater than that of the organic halides (TCE =  $0.76 \times 10^{-6}$  M at 100 ppb).

The rate constants for reaction of TCE, PCE and bicarbonate with OH radicals can be used as a basis to predict the efficiency Q of radical quenching by TCE and PCE, defined as the percentage of OH radicals that are quenched by TCE or PCE respectively. Assuming bicarbonate is the principal quenching agent, Q may be approximated by equation (24):

$$Q = \frac{k_{5a}[\text{TCE}]}{k_{5a}[\text{TCE}] + k_{10}[\text{HCO}_3^-]} \times 100 \sim \frac{k_{5a}[\text{TCE}]}{k_{10}[\text{HCO}_3^-]} \times 100 \quad (24)$$

Batch scale runs to test the effect of bicarbonate softening of Los Angeles ground water were not conducted in this study (however, see the following paper). The effect of bicarbonate is well illustrated, however, in the experimental data shown in Figure 7 and Table 4. Arrowhead distilled water, ( $[\text{HCO}_3^-] < 0.1$  mM) was used as the source of water for this set of runs. Sodium bicarbonate was used to adjust the bicarbonate level and pH was adjusted by addition of sodium phosphate buffer solution. Table 4 summarizes rate constants from these runs as a function of bicarbonate alkalinity. Several features of this data are interesting.

First, as shown in Figure 7, the rate of TCE oxidation is so fast in this water at low bicarbonate levels that TCE is degraded from 500 ppb to 3 ppb within 10 minutes. Under these conditions it is difficult to obtain good rate data with our experimental system. Second, values of  $k_{O,TCE}/k_{O,PCE}$  are in the range predicted from equation (23) for OH radical reactions. Third, the rate constants at low alkalinity values are a factor of two to three greater than those observed at similar ozone:peroxide doses in the natural groundwater. This is apparently due to the fact that there are other radical scavengers in natural waters that decrease the efficiency of the oxidation of the olefins. Fourth, the value of the product of  $k_O$  times the molar bicarbonate level is a constant at a given ozone dose rate, as predicted by equation (21). Finally, the values of the efficiency factor  $Q$  show that at the high alkalinity values of North Hollywood ground water, TCE and PCE are not using more than a few percent of the available OH radicals. These results verify the expected effect of bicarbonate ion and suggest that softening prior to oxidation may be a cost effective addition to the  $O_3/H_2O_2$  process under some conditions.

#### Oxidant Doses for 95% Removal of Substrates

The rate constants in Tables 1 and 3 may be used to calculate the dose of ozone required for 95% destruction of

the two olefins (Table 5). A detailed analysis of this data will not be given here; however, it is clear that the results suggest that the process is quite promising. Further details of cost/effectiveness of the process are given in the following paper.

#### Evidence for Enhancement of Ozone Mass Transfer

When liquid phase reaction rates are high, the mass transfer coefficient  $k_1^*a$  may be larger than the value without rapid reaction  $k_1a$ . The enhancement factor  $E$  is defined as the ratio  $k_1^*a/k_1a$ .

Direct measurements of  $k_1a$  in the CSTR used in this work give a value of  $k_1a$  of  $4.6 (\pm 0.4) \times 10^{-4} \text{ s}^{-1}$ . These runs were made in water from North Hollywood Well No. 14 at three different ozone doses with no peroxide added (Figure 8).

When peroxide levels are high there is essentially no residual ozone found in the liquid phase or in the ozone off-gas. For example, in a run with ozone dose at  $14.9 \text{ mg-min}^{-1}$  and peroxide dose at  $10 \text{ mg-min}^{-1}$ , the residual ozone levels were near our detection limit for the indigo method ( $0.1 \text{ mg-L}^{-1}$ ). That is, all of the ozone added is consumed ( $>98\%$ ). Hence, we may assume that  $[O_3] \ll P/H$  and for all practical purposes,  $d[O_3]/dt$  is zero. Equation (25) may then

be used to calculate a lower limit value for  $k_1^*a$ :

$$k_1^*a > \frac{\text{Ozone dose}(\text{mole-L}^{-1}\text{-s}^{-1}) \cdot \text{Ozone utilization (0.98)}}{P (\text{atm}) / H (\text{atm-L-mole}^{-1})} \quad (25)$$

The value calculated from equation (25) is  $k_1^*a = 7.8 \times 10^{-4} \text{ s}^{-1}$ . Thus, the mass transfer enhancement factor for these conditions is at least a factor 1.7.

#### CONCLUSION

Direct ozonation of TCE and PCE in a high alkalinity ground water is a relatively slow process and little effect is seen when the pH is increased from 4 to 10. The addition of hydrogen peroxide up to a  $\text{H}_2\text{O}_2/\text{O}_3$  ratio of about 0.5-0.7 (w/w) accelerates the oxidation of TCE by a factor of two to three times and PCE from two to six times, depending on the ozone dose. Because of an apparent mass transfer effect, increasing the hydrogen peroxide dose rate beyond a certain level does not increase the oxidation rate of TCE and PCE., however, at higher ozone dose rates further rate enhancements can be expected. Relative rate data for TCE vs. PCE oxidation suggests that the principal species involved in the oxidation is the OH radical. Processes that utilize hydroxyl radicals to remove water contaminants are less efficient in high alkalinity water because of the presence of radical scavengers such as  $\text{HCO}_3^-$  and  $\text{CO}_3^{2-}$ . In the present case, the



data suggest that TCE and PCE oxidation is still a promising process even though only a small percentage of the OH radicals are used for TCE/PCE oxidation. Water softening may therefore be used to further increase the effectiveness of the process.

#### Acknowledgements

This work was supported by the city of Los Angeles Department of Water and Power and the USEPA through CR-813188, R. Miltner Project Officer. This article has not been subjected to review by EPA. Therefore, it does not necessarily reflect the views of the agency, and no official endorsement should be inferred. The authors are grateful to Marco Aieta, Rhodes Trussell and Carol Tate of James M. Montgomery, Consulting Engineers and to Larry McReynolds of LADWP for helpful discussions.

## REFERENCES

1. Federal Register, (1987).
2. Glaze, W.H., "Drinking-Water Treatment With Ozone," Environmental Science & Technology, Volume 21, No. 3, pp. 224-230, 1987.
3. Glaze, W.H., J.W. Kang, and E.M. Aieta, "Ozone-Hydrogen Peroxide Systems for Control of Organics in Municipal Water Supplies," in The Role of Ozone in Water and Wastewater Treatment, Proceedings of the Second International Conference, Edmonton, Alberta, p. 233 (28-29 April 1987).
4. Glaze, W.H., J.W. Kang, and D.H. Chapin, "The Chemistry of Water Treatment Processes Involving Ozone, Hydrogen Peroxide and Ultraviolet Radiation", Ozone: Science & Engineering, 1987 (in press).
5. Farhataziz and A.B. Ross., "Selective Specific Rates of Reactions of Transients in Water and Aqueous Solutions. P III. Hydroxyl Radical and Perhydroxyl Radical and Their Radical Ions", Natl. Stand. Ref. Data Ser. (U.S. Natl. Bur. Stand.) No 59 (1977).
6. (following paper)
7. Yocum, E.H., "Ozone Mass Transfer in Stirred Vessels," Proceedings, 86th National Meeting, American Institute of Chemical Engineers, April 1-5 (1979).
8. Flamm, D.L., "Analysis of Ozone at Low Concentrations With Boric Acid Buffered KI," Environ. Sci. & Technol., 11:10:978 (October 1977).
9. Bader, H., and J. Hoigné, "Determination of Ozone in Water by the Indigo Method: A Submitted Standard Method," Ozone Sci. & Engng., 4:169 (1982).
10. Masschelein, W., M. Denis and R. Ledent, "Spectrophotometric Determination of Residual Hydrogen Peroxide," Water & Sewage Works, pp. 69-72, August 1977.
11. Lazrus, A.L., G.L. Kok, S.N. Gitlin, J.A. Lind, and S.E. McLaren, "Automated Fluorometric Method for Hydrogen Peroxide in Atmospheric Precipitation", Anal. Chem. 57:917-922 (1985).

12. Association of Official Analytical Chemists, Official Methods of Analysis, W. Horwitz, editor, p. 545 (1980).
13. Hoigné, J. and H. Bader, "Rate Constants of Reactions of Ozone With Organic and Inorganic Compounds in Water, I - Non-Dissociating Organic Compounds," *Water Research*, 17:173 (1983).
14. Staehelin, J., and J. Hoigné, "Decomposition of Ozone in the Presence of Organic Solutes Acting as Promoters and Inhibitors of Radical Chain Reactions," *Environ. Sci. & Technol.*, 19:1206 (1985).
15. Staehelin, J., and J. Hoigné, "Decomposition of Ozone in Water: Rate of Initiation by Hydroxide Ion and Hydrogen Peroxide," *Environ. Sci. & Technol.*, 16:676 (1982).
16. Buhler, R.E., J. Staehelin, and J. Hoigné, "Ozone Decomposition in Water Studied by Pulse Radiolysis. 1.  $\text{HO}_2/\text{O}_2$  and  $\text{HO}_3/\text{O}_3$  as Intermediates," *J. Phys. Chem.*, 88:2560 (1984).
17. Staehelin, J., R.E. Buhler, and J. Hoigné, "Ozone Decomposition in Water Studied by Pulse Radiolysis. 2.  $\text{OH}$  and  $\text{HO}^4$  as Chain Intermediates," *J. Phys. Chem.*, 88:5999 (1984).
18. Forni, L., D. Bahnemann, and E.J. Hart, "Mechanism of the Hydroxide Ion Initiated Decomposition of Ozone in Aqueous Solution," *J. Phys. Chem.*, 86:255 (1982).
19. Sehested, K., J. Holoman, E. Bjergbakke, and E.J. Hart, "Ultraviolet Spectrum and Decay of the Ozonide Ion Radical,  $\text{O}_3^-$ , in Strong Alkaline Solution," *J. Phys. Chem.*, 86:2066 (1982).
20. Christensen, H.S., K. Sehested and H. Corfitzan, "Reaction of Hydroxyl Radicals with Hydrogen Peroxide at Ambient and Elevated Temperatures", *J. Phys. Chem.*, 86:1588 (1982).

#### LEGEND OF FIGURES

Figure 1. Schematic Diagram of  $O_3/H_2O_2/UV$  Experimental System.

Figure 2. Scheme showing the principle species in the decomposition of ozone initiated by hydroxide ions and OH radical quenching by scavengers.

Figure 3. Effect of pH on the ozonation of TCE in North Hollywood well water. Ozone dose: 15 mg/min; Bicarbonate alkalinity: 200 mg/L as  $CaCO_3$ .

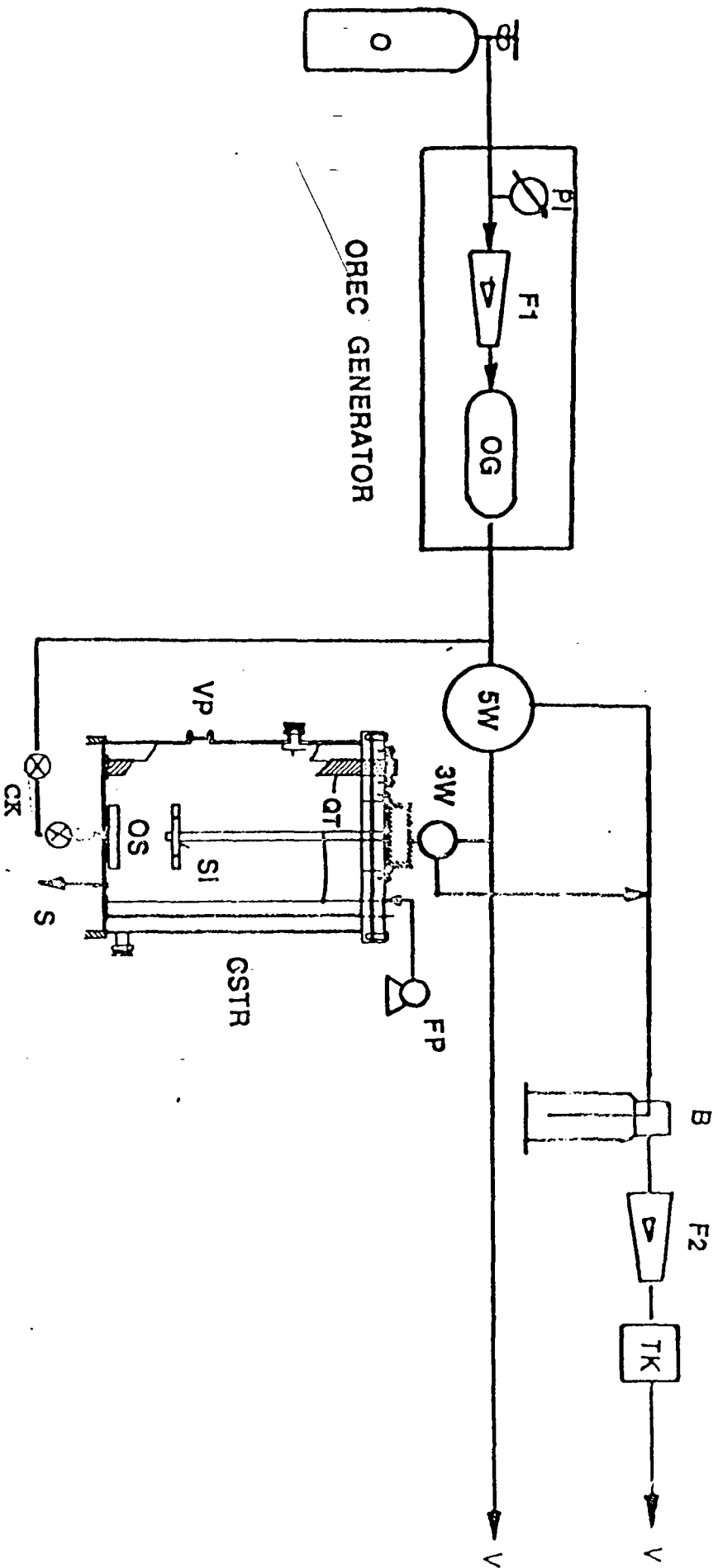
Figure 4. Pseudo first-order plot for destruction of TCE by  $O_3/H_2O_2$  process in North Hollywood well water. Ozone dose: 14.9 mg/min; Bicarbonate alkalinity: 300 mg/L as  $CaCO_3$ ; pH: 7.2-7.4.

Figure 5. Pseudo first-order plot for destruction of PCE by  $O_3/H_2O_2$  process in North Hollywood well water. Ozone dose: 14.9 mg/min; Bicarbonate alkalinity: 300 mg/L as  $CaCO_3$ ; pH: 7.2-7.4.

Figure 6. Effect of hydrogen peroxide on the pseudo first-order rate constants of oxidation of TCE in North Hollywood well water.

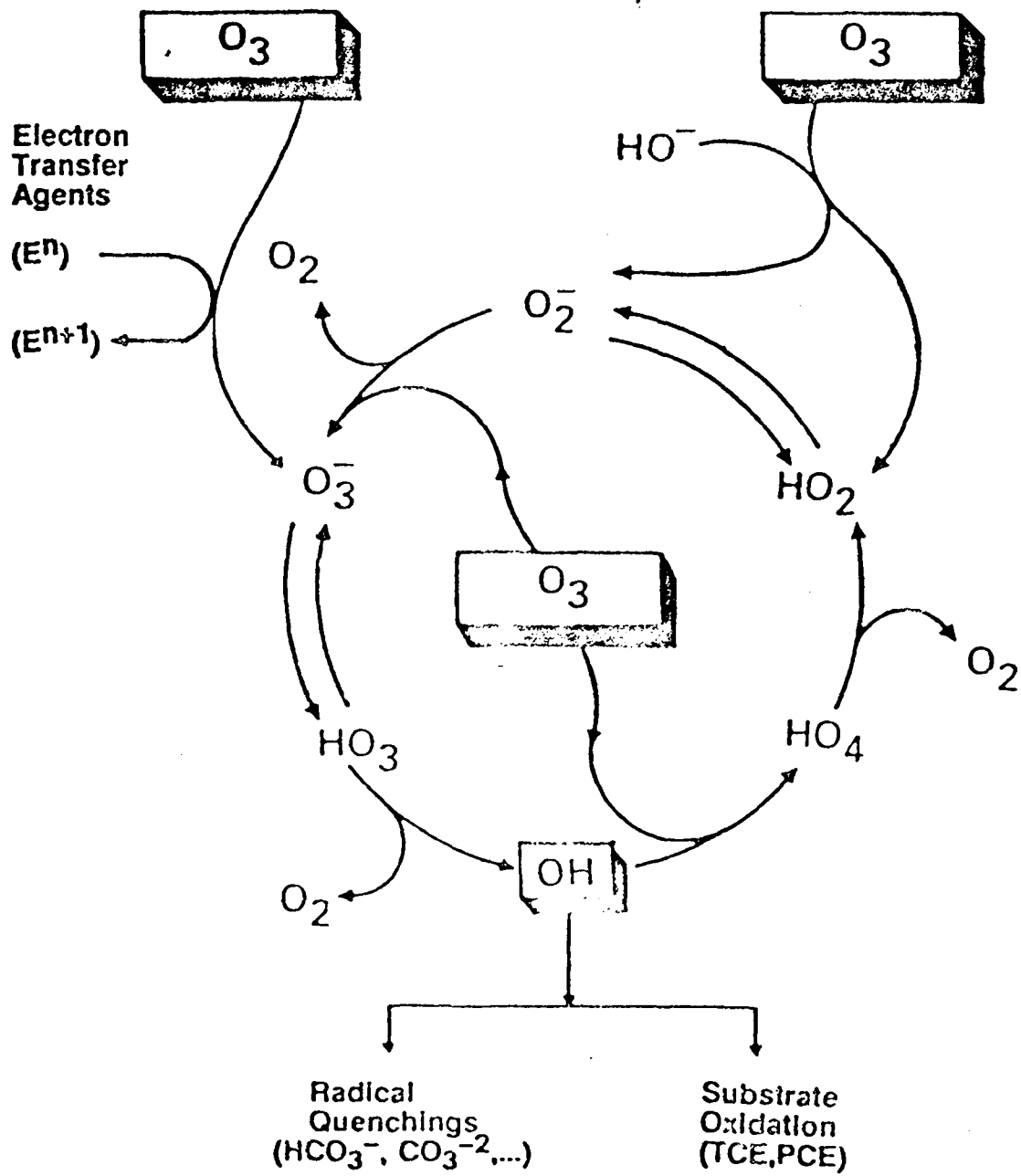
Figure 7. Effect of bicarbonate on the  $O_3/H_2O_2$  process for destruction of TCE in Arrowhead distilled water. Ozone dose: 4.5 mg/min,  $H_2O_2$  dose: 2.0 mg/min.

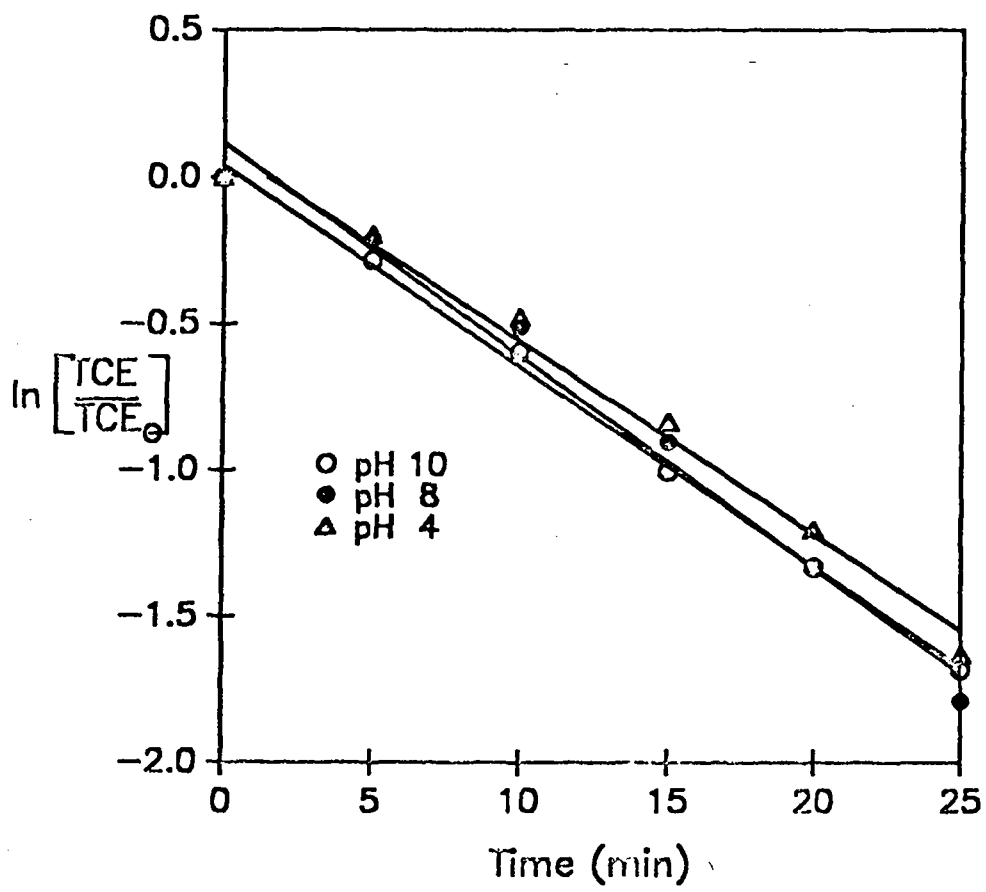
Figure 8. Transfer of ozone into the CSTR with water from North Hollywood well No. 14. No added peroxide.

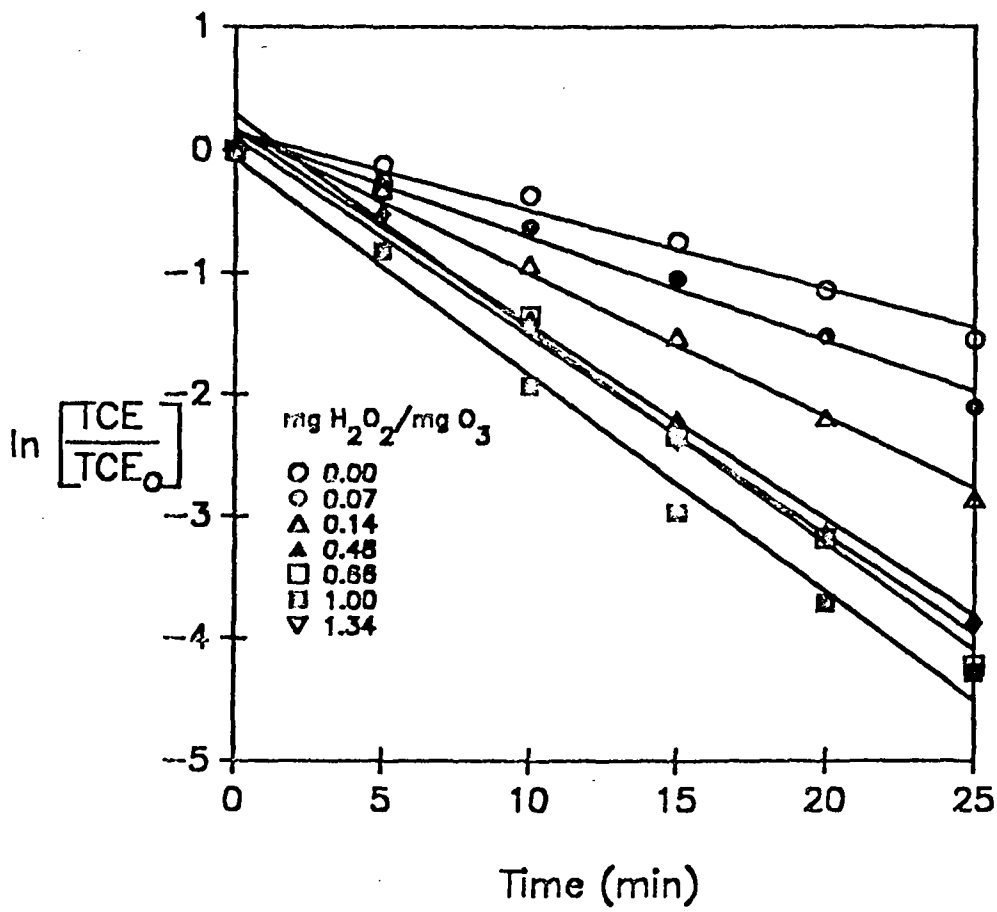


OREC GENERATOR

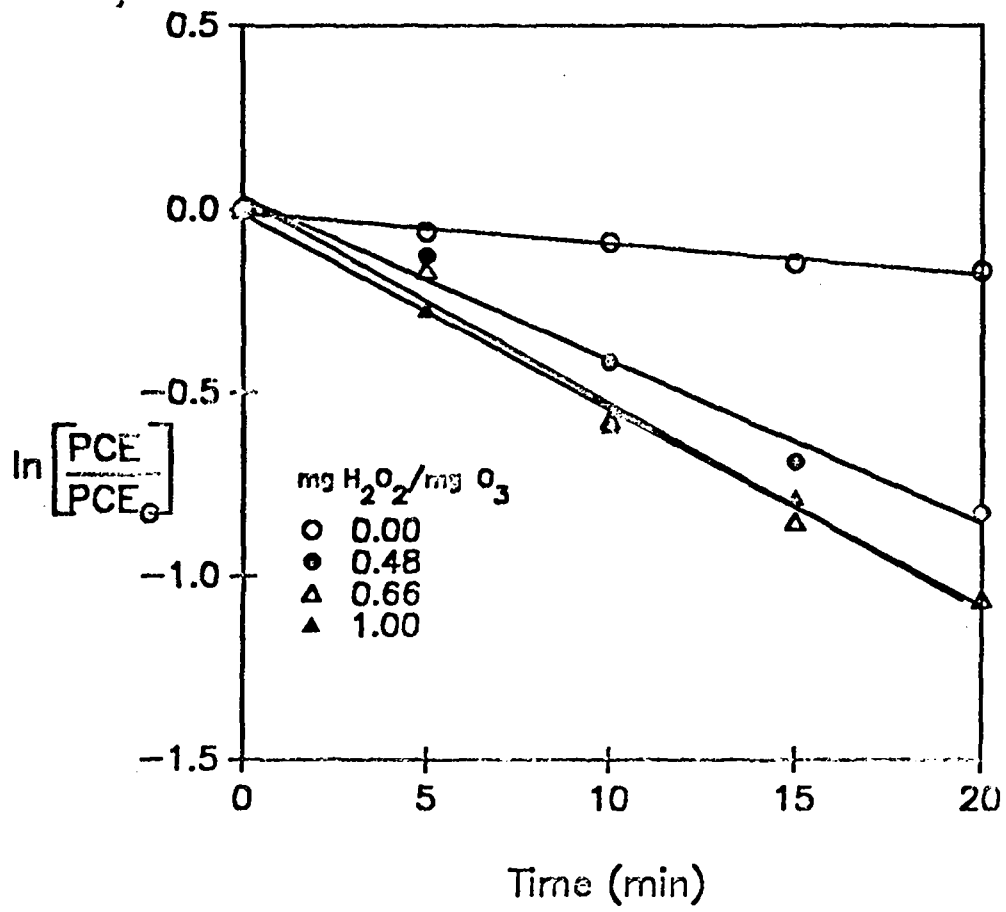
- O : Oxygen Cylinder
- CK : Check Valve
- F1, F2 : Rotameter
- 5W : 5-Way Valve
- 3W : 3-Way Valve
- FP : Hydrogen Peroxide Feed Pump
- B : Bubbler
- TK : Thermal Ozone Kill Unit
- V : Vent
- S : Sample Point
- PI : Pressure Regulator and Indicator
- QT : Quartz UV Lamp Well
- OS : Ozone Gas Sparger
- VP : Viewing Port (one of four)
- CSTR : Continuous Stirred Tank Reactor



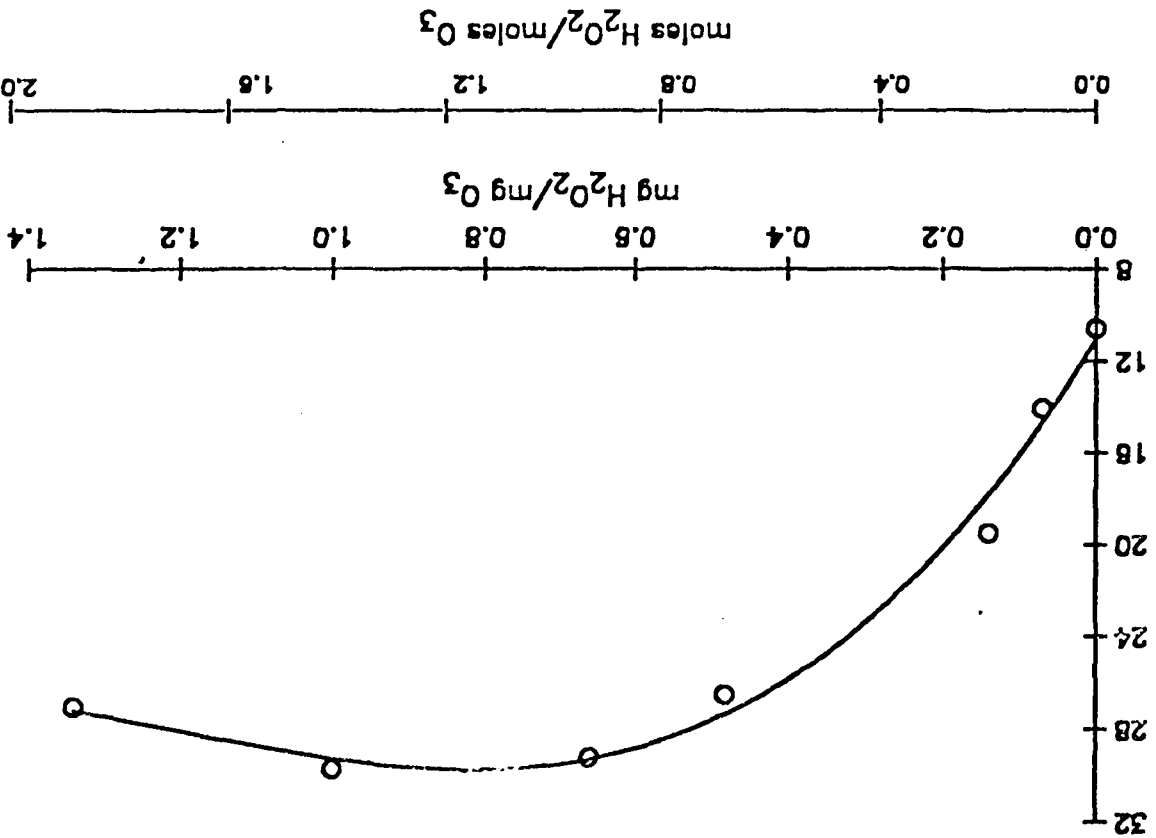


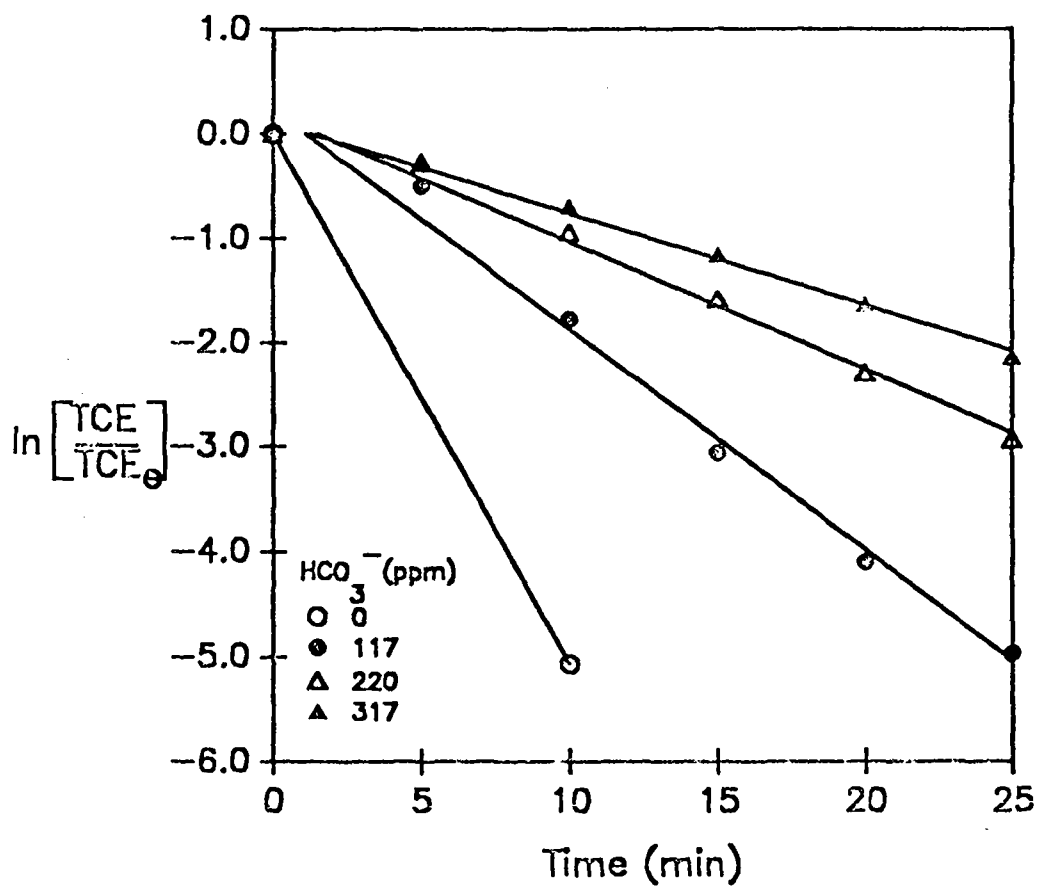






Pseudo-first-order Rate Constant ( $10^4 \text{ sec}^{-1}$ )





$k_L a$  DETERMINATION

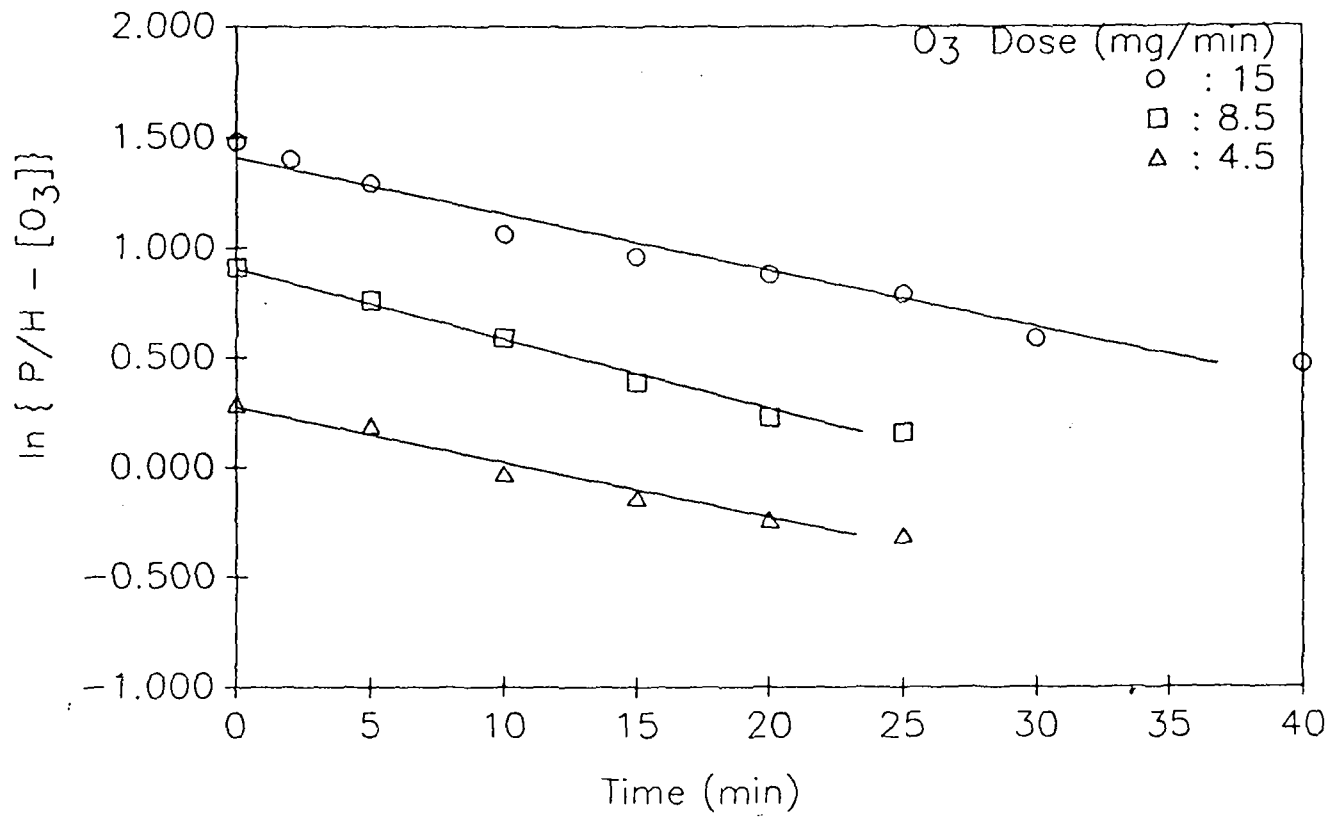


TABLE 1

Pseudo-First Order Rate Constants for  
the O<sub>3</sub>/pH System

NORTH HOLLYWOOD WELL NO. 26

Rate Constants x 10<sup>4</sup> (s<sup>-1</sup>)

O <sub>3</sub> Dose mg/min	pH = 4		pH = 8		pH = 10	
	TCE	PCE	TCE	PCE	TCE	PCE
	4.5	5.0	2.8	5.0	2.4	6.1
8.4	7.8	3.0	8.4	3.1	9.2	4.6
15.1	11.0	2.3	12.1	3.0	11.4	4.5

TABLE 2  
PRINCIPAL REACTIONS IN THE O<sub>3</sub>/H<sub>2</sub>O<sub>2</sub> PROCESS

REACTION	CONSTANT	REFERENCE
$H_2O_2 \rightleftharpoons HO_2^- + H^+$	$K_{PER}=1.6 \times 10^{-12} M$	
1. $HO_2^- + O_3 \rightarrow O_3^- + HO_2$	$k_1=2.8 \times 10^6 M^{-1} S^{-1}$	(15)
$HO_2 \rightleftharpoons H^+ + O_2^-$	$K_{HO_2}=1.6 \times 10^{-5} M$	(15)
2. $O_2^- + O_3 \rightarrow O_3^- + O_2$	$k_2=1.6 \times 10^9 M^{-1} S^{-1}$	(16)
3. $O_3^- + H^+ \rightarrow HO_3$	$K_3=6.3 \times 10^{-9} M$	(16)
4. $HO_3 \rightarrow OH + O_2$	$k_4=1.1 \times 10^5 S^{-1}$	(16)
5a. $OH + TCE \rightarrow \text{Products} (?)$	$k_{5a}=4.0 \times 10^9 M^{-1} S^{-1}$	(5)
5b. $OH + PCE \rightarrow "$	$k_{5b}=2.3 \times 10^9 M^{-1} S^{-1}$	(5)
6. $OH^- + O_3 \rightarrow O_2^- + HO_2$	$k_6=70 M^{-1} S^{-1}$	(18)
7. $OH + HO_2^- \rightarrow OH^- + HO_2$	$k_7=7.5 \times 10^9 M^{-1} S^{-1}$	(20)
8. $OH + H_2O_2 \rightarrow H_2O + HO_2$	$k_8=2.7 \times 10^7 M^{-1} S^{-1}$	(20)
9. $OH + S_i \rightarrow \text{Products} (?)$		
10. $OH + HCO_3^- \rightarrow OH^- + HCO_3$	$k_{10}=1.5 \times 10^7 M^{-1} S^{-1}$	(5)
11. $OH + CO_3^{=} \rightarrow OH^- + CO_3^{=}$	$k_{11}=4.2 \times 10^8 M^{-1} S^{-1}$	(5)
12. $HCO_3^- \rightarrow H^+ + CO_3^{=}$	$K_{HCO_3}=5.0 \times 10^{-11} M$	

$\sum S_i$  is the sum of the various matrix substrates that quench hydroxyl radicals.

TABLE 3

Pseudo-First Order Rate Constants  
for the O<sub>3</sub>/H<sub>2</sub>O<sub>2</sub> System

NORTH HOLLYWOOD WELL NO. 14

Rate Constants x 10<sup>4</sup> (s<sup>-1</sup>)O<sub>3</sub> Dose: 4.6 mg/mink<sub>O</sub>

mg H <sub>2</sub> O <sub>2</sub> /mg O <sub>3</sub>	TCE	PCE	TCE/PCE
0.00	4.1	1.9	2.2
0.11	5.0	2.2	2.3
0.33	8.8	4.4	2.0
0.54	8.1	4.1	2.0
1.00	7.0	4.0	1.8

O<sub>3</sub> Dose: 8.4 mg/mink<sub>O</sub>

mg H <sub>2</sub> O <sub>2</sub> /mg O <sub>3</sub>	TCE	PCE	TCE/PCE
0.00	7.2	2.4	3.0
0.12	10	4.1	2.4
0.36	16	7.1	2.7
0.60	18	8.7	2.1
1.00	20	7.3	2.7

O<sub>3</sub> Dose: 14.9 mg/mink<sub>O</sub>

mg H <sub>2</sub> O <sub>2</sub> /mg O <sub>3</sub>	TCE	PCE	TCE/PCE
0.00	11	1.4	7.9
0.07	14	2.6	5.4
0.14	20	7.1	2.8
0.48	27	7.4	3.6
0.67	29	8.9	3.2
1.00	30	7.6	3.9
1.34	27	9.0	3.0

TABLE 4

Effect of Bicarbonate on the Rate of Oxidation  
of TCE and PCE with the O<sub>3</sub>/H<sub>2</sub>O<sub>2</sub> System<sup>1</sup>

[HCO <sub>3</sub> <sup>-</sup> ] (mM)	H <sub>2</sub> O <sub>2</sub> : 10 mg/min O <sub>3</sub> : 15 mg/min			H <sub>2</sub> O <sub>2</sub> : 2 mg/min O <sub>3</sub> : 4.5 mg/min			Q <sub>TCE</sub> <sup>1</sup>
	k <sub>O</sub> x 10 <sup>3</sup> s <sup>-1</sup>			k <sub>O</sub> x 10 <sup>3</sup> s <sup>-1</sup>			
	TCE	PCE	TCE/PCE	TCE	PCE	TCE/PCE	
0.0	>16.3	>11.1	--	>8.4	>6.8	--	---
2.0	11.4	5.9	1.8	3.5	2.0	1.9	10
3.6	6.5	3.7	1.8	2.0	1.1	1.8	6
5.2	5.2	2.7	1.9	1.5	0.8	1.4	4

<sup>1</sup> Q: Efficiency of TCE of OH radicals based on equation (24); calculated at a concentration of TCE of 100 ppb and at lower of two dose rates shown above.



TABLE 5

Dose Required for 95 % Removal of TCE and PCE  
North Hollywood Well No. 26

Process	O <sub>3</sub> (mg/L)		H <sub>2</sub> O <sub>2</sub> (mg/L)	
	TCE	PCE	TCE	PCE
O <sub>3</sub> <sup>1</sup>	9	33	-	-
O <sub>3</sub> /H <sub>2</sub> O <sub>2</sub> <sup>2</sup>	4	12	2	8

Conditions: 1: O<sub>3</sub> Dose: 15 mg/min, pH: 8.0;  
 2: O<sub>3</sub> Dose: 15 mg/min, H<sub>2</sub>O<sub>2</sub> Dose: 10 mg/min;  
 1-2: Initial TCE and PCE concentrations: 500  
 and 50 ppb; Alkalinity: 200 mg/L as CaCO<sub>3</sub>.

**INACTIVATION AND/OR DESTRUCTION  
OF THE CYSTS OF GIARDIA WITH PHOTOZONE**

Charles P. Hibler, Department of Pathology,  
College of Veterinary Medicine and Biomedical Sciences,  
Colorado State University,  
Fort Collins, Colorado 80523

December 19, 1984

**INTRODUCTION:**

At the request of Dr. Robert McGregor, Water Management, Inc., 1660 South Albion Street, Suite 513, Denver, Colorado 80222, we performed seven static tests to determine if photozone was effective in the inactivation and/or destruction of the cysts of Giardia duodenalis of human origin.

Water Management, Inc., is investigating the potential effectiveness of photozone equipment at an established water treatment plant at Aspen, Colorado, as an additional safeguard against Giardia. The existing plant is a rapid sand filtration with chemical flocculation and coagulation followed by chlorination in sufficient quantity to provide the required amount of free chlorine throughout the distribution system. Photozone will be introduced as an added safeguard and as an application that possibly will be more effective in inactivation and/or destruction of Giardia cysts. Therefore, Water Management, Inc., wanted to determine if photozone together with a small amount of free chlorine was effective.

The time of year when this system possibly would be at risk for Giardia would be in the fall and winter months when temperatures are between 0-5°C and turbidity readings are in the range of 0.5-0.8 NTU. The static test was designed to approximate these conditions as near as possible in Trials I - III on October 24, 1984. Based on the results of these tests, additional tests were conducted on November 7-8, 1984, to confirm the results of the first tests and to determine if there would be any reductions in the effectiveness of the photozone at higher levels of turbidity.

### TRIALS I - III

#### Materials and Methods:

##### Location:

The Poudre River at Fort Collins Water Treatment Plant #1 was chosen as the site for this test because water temperatures this time of year range between 0-4°C, turbidity is between 0.5-0.7 NTU and the laboratory at the Water Treatment Plant has sufficient equipment for measuring the temperature, turbidity, and free chlorine; moreover, the plant is a source of power for the equipment necessary.

##### Methods:

For the purpose of this series of static tests, a 55-gallon nalgene tank was positioned near the Poudre River and filled with raw Poudre River water. Temperature, turbidity, free chlorine, and photozone levels were established by representatives of Water Management, Inc.

##### Source of Photozone:

The photozone was generated by a ultraviolet tube through which ambient air concentrated with oxygen was passed. The oxygen concentration of the concentrated air supply was estimated to be 28 percent by weight compared to 23 percent by weight for normal air. The purpose of the oxygen concentrator in the tests

was to enhance the overall production of photozone to reduce the setup time for each test. The photozone was then passed into the nalgene drum and circulated by means of a perforated PVC tube coiled at the bottom of the drum. Free photozone was monitored by the oxidation/reduction potential (ORP) expressed in millivolts. For all the tests, the level of photozone was maintained between 0.3 and 0.6 mg/l.

Source of Giardia duodenalis cysts:

Cysts were obtained in a human stool specimen through the courtesy of a local hospital. Cysts were diluted in distilled water, strained through several layers of gauze to remove the larger material and maintained at 5°C in distilled water. Counting of the cysts was performed by direct microscopic examination of 50 microliter subsamples (four replicate counts) and then extrapolated to determine cysts/mililiter and subsequently cysts/sample. This technique provides a reasonable level of accuracy but is not an absolute figure. This source was determined to have a total of  $6.5 \times 10^6$  cysts/ml.

Although the morphologic quality of these cysts was superb, morphologic quality does not necessarily mean that the cysts were alive/or infectious. This can only be determined by a laboratory excystation procedure or the introduction of these cysts into a suitable biologic model. Our laboratory uses the Mongolian gerbil (Meriones unguiculatus) to determine infectivity. The standard procedure is to introduce 5,000 cysts per animal into each of five Mongolian gerbils aged 7-8 weeks. If these cysts are highly infectious, the gerbils will begin producing cysts as a result of the infection on day four post inoculation. They will continue to produce cysts for the next 4-5 days reaching a peak cyst productivity on Day 6 to 7 post inoculation. If the sample is highly infectious, the total fecal output of five Mongolian gerbils over a period of 24 hours should produce between 20 and 30 million cysts. Infection of five Mongolian gerbils with

the cysts from this human source resulted in a cyst production 7 days later of  $27.3 \times 10^6$  Giardia cysts. The cysts from these gerbils were thoroughly cleaned as given above, diluted in distilled water, counted as closely as possible, and maintained in distilled water until the time of the trial (two days later).

#### PROTOCOL:

The protocol established was to run a series of three static tests maintaining a temperature of 0-4°C, a turbidity of 0.5-0.8 NTU, a constant amount of photozone, and a varying amount of free chlorine at each trial. During each trial, subsamples containing Giardia cysts were to be withdrawn and the chlorine and photozone denatured with the addition of 1% sodium thiosulfate. Each trial called for a 30-minute treatment subsample and a 120-minute treatment subsample. The Giardia cysts contained in these subsamples were to be examined for morphologic quality and then introduced orally into susceptible Mongolian gerbils to determine if they were inactivated and/or destroyed.

For each trial, once the free photozone and the free chlorine and other parameters had been established, a total of  $5.13 \times 10^5$  Giardia cysts were introduced into the nalgene drum (10,000 per gallon). At 30 minutes post exposure a 15-gallon sample was withdrawn from the drum with the aid of a small centrifugal pump and the suspended material trapped on a one micron (nominal rating) polypropylene filter. As the subsample was being extracted, sodium thiosulfate was trickle-dosed into the line. This same procedure was repeated for the 120-minute trial. Filters containing Giardia cysts and other material present in the raw water were refrigerated, taken to the laboratory, and processed in distilled water. Processing a polypropylene filter calls for cutting the fibers away from the core and hand washing in distilled water. Once all the filters had been processed, they were refrigerated at 5°C until the following morning when they

were processed for animal inoculation. Distilled water in gallon jars containing Giardia cysts and other material were concentrated by centrifugation until the contents of the filter had been concentrated into a 10 milliliter volume. Subsamples of this material were then examined for Giardia cysts to determine morphologic quality and to calculate the total numbers for animal inoculation.

The protocol called for the inoculation of 7-10 Mongolian gerbils with Giardia cysts from each trial. A group of 7-10 Mongolian gerbils were to be inoculated with cysts from the source material to determine infectivity. A comparable number of negative controls was also included. In addition, a group of 7-10 gerbils were to be orally inoculated with cysts that had been maintained in river water during the trial and exposed to 1% sodium thiosulfate.

#### RESULTS:

Five days post-exposure the Mongolian gerbils infected with the source material (positive controls) passed  $35 \times 10^6$  Giardia cysts in a 24-hour period. The Mongolian gerbils infected with the river water control passed a total of  $32 \times 10^6$  Giardia cysts in a 24-hour period. The Giardia source material and the Giardia cysts exposed to river water were rated morphologically superb (microscopic examination) the day following the trials and for one week thereafter (following which they were not further examined). However, in each photozone trial only a few Giardia cysts could be found following 30 minutes exposure to the combination of ozone and free chlorine; at 120 minutes exposure to free chlorine no Giardia cysts could be found. Therefore, no Mongolian gerbils were inoculated with any of the material.

#### DISCUSSION:

The discovery that only a few Giardia cysts were present in the 30 minute post-exposure subsamples was surprising. Even more surprising was the obvious fact

that these cysts were dead. The internal structures were shrunken and shriveled to the degree that they were unrecognizable as cysts. Re-examination of the protocol used indicates that the combination of photozone and free chlorine killed the cysts before the 30-minute contact time. Even though the photozone and free chlorine were denatured immediately with the addition of 1% sodium thiosulfate, apparently the deterioration process continued while the cysts were refrigerated in distilled water overnight, thus destroying or rendering unrecognizable the cysts that were present. It has been established, and it is our experience, that the amount of free chlorine alone in this system (0.21 to 0.58 mg/l) is inadequate to kill the cysts in 30 minutes at 0-4°C, much less to effect cyst destruction. Moreover, the examination of Giardia cysts exposed to this amount of free chlorine reveals that the morphologic quality of cysts can be maintained at 5°C for at least three and usually four days before the internal structures become distorted and the cysts become unrecognizable. In addition to an almost complete destruction of all Giardia cysts present in this raw water, the crustaceans, free-living nematodes, nematode eggs, and crustacean eggs found normally in this raw water (and present in the river water control) were not present in these trial samples.

#### **RECOMMENDATIONS:**

The combination of photozone and free chlorine, together with the holding time post treatment obviously effected total destruction of the Giardia cysts. It was recommended that a subsequent series of trials be initiated and subsamples withdrawn for morphologic analysis and animal inoculation at 5, 10, 20, and 30-minute intervals. It was further recommended that these samples be processed as soon as possible after the photozone and the chlorine had been denatured. Cyst deterioration to the point of complete destruction obviously continued even

though the photozone and chlorine have been denatured. It was further recommended that the subsequent trials be performed using only photozone and not a combination of photozone and chlorine to determine the effect of ozone alone on cyst inactivation and/or destruction. It was also recommended that further tests be conducted at higher turbidity levels to determine any interferences with photozone.

These recommendations were carried out in Trials IV - VII on November 7-8, 1984.

#### TRIALS IV - VII

##### Introduction:

The results of Trials I through III indicated that 0.21 - 0.58 mg/l free chlorine in combination with 0.3 - 0.6 mg/l of photozone not only inactivated and/or killed Giardia cysts but also completely destroyed the great majority. However, the procedure used in Trials I through III necessitated holding the cysts overnight in a refrigerator at 5°C before animal inoculation. The following morning very few cysts could be found in the 30-minute contact time trials while none could be found in the 120-minute contact time trials. Even though the activity of the chlorine and the photozone was stopped by the addition of 1% sodium thiosulphate, we felt that cyst deterioration continued despite the inactivation of the photozone and the free chlorine. Therefore, at the request of this investigator a second series of trials was initiated. In general, the subsequent trials called for contact times with photozone and free chlorine of 5 minutes, 10 minutes, 20 minutes, 30 minutes, and one hour. These were done, in part, to determine if there was any physical deterioration of the cysts as a result of exposure to photozone and chlorine, and also to determine if the activity of photozone and chlorine in combination would inactivate and/or kill the cysts at an earlier time than 30 minutes. Previous investigators have shown that photozone



alone will inactivate and/or kill Giardia cysts as early as 5 minutes at 1 mg/l. However, these investigators were using distilled water, Giardia muris, and laboratory excystation of cysts as the indicator of inactivation or death. Tests were also conducted to determine the effectiveness of photozone without chlorine and at turbidity levels in the range of 2.6 - 4.6 NTU.

A series of four trials were planned. Trial IV would examine cysts for morphology and animal inoculation at 5, 10, 20, 30, and 60 minutes using Poudre River water with a turbidity of 0.74 NTU, a temperature of 4.1°C, 0.3 - 0.6 mg/l photozone and 0.21 mg/l free chlorine. Trial V was designed to examine cysts for morphology and animal inoculation at 30 and 60 minutes using raw Poudre River water with the same level of photozone and no chlorine. Trial VI was designed to examine cysts morphologically and by animal inoculation using raw Poudre River water with the same level of photozone, no chlorine, and increasing the turbidity to 2.6 NTU with Bentonite. Trial VII was designed to examine the cysts morphologically and by animal inoculation after 30 and 60 minutes exposure to raw Poudre River water with the same level of photozone, no chlorine, and 4.6 NTU turbidity. A concerted effort was made to keep the lag time at a minimum (the period between inactivation of the photozone and the morphologic examination or inoculation of animals).

#### Materials and Methods:

##### Location:

The location of these tests and the conditions for these tests were the same as in Trials I through III.

##### Methods:

The methods of this series of tests were the same as in Trials I through III.

Source of Photozone:

The source of the photozone for these trials was the same as the source for the Trials I through III.

Source of Giardia doudenalis cysts:

The source of the cysts was the same as for Trials I through III, and was determined to have a total of  $37.0 \times 10^6$  cysts/ml. These cysts were likewise introduced into the Mongolian gerbil with essentially the same results as in Trials I through III.

PROTOCOL:

**General:** For trials IV, V, and VI the 55-gallon Nalgene drum was seeded with 2 million Giardia cysts (40,000 per gallon); for Trial VII an additional 2 million Giardia cysts were added, making a total of 4 million (80,000 per gallon) for that particular trial.

**Trial IV:** For this trial, raw Poudre River water at a temperature of 4.1°C, turbidity 0.73, photozone 0.3 - 0.6 mg/l, and 0.21 mg/l chlorine was used. Five minutes after introduction of the cysts a 1 gallon grab-sample was removed and sufficient sodium thiosulfate was added to provide a 1% solution. The same procedure was used at 10 minutes, 20 minutes, 30 minutes, and one hour. These one gallon grab-samples were siphoned through a 5 micron nucleopore membrane, the membrane washed with distilled water, and the resulting filtrate centrifuged for 5 minutes at 1500 rpm. Cysts were examined for morphologic quality and then introduced into five Mongolian gerbils at an estimated 5,000 cysts/animal.

**Trial V:** Photozone was generated to maintain 0.3 - 0.6 mg/l. Raw Poudre River water at a temperature of 4.0°C and a turbidity of 0.75 NTU was used. At 30 minutes and 60 minutes post-exposure time 5 gallons of the suspension was

pumped through a 1 micron polypropylene filter. This filter was cut to the core, processed in distilled water, and filtered through a 5 micron Nucleopore membrane. The filtrate washed off the nucleopore membrane was centrifuged for 5 minutes at 1500 rpm and the cysts were examined for morphologic quality and then inoculated into five Mongolian gerbils at an estimated 5,000 cysts/animal.

Trial VI: Bentonite was added to the Poudre River water to raise the turbidity to 2.6 NTU. Water temperature was 4.5°C and photozone was maintained at 0.3 - 0.6 mg/l. At 30 minutes and 60 minutes five gallon samples were pumped through a one micron polypropylene filter and the samples processed as above.

Trial VII: For Trial VII, an additional 2 million Giardia cysts were added to the existing quantity of water, and an additional amount of Bentonite was added to raise the turbidity to 4.6 NTU. Water temperature was 4.6°C. Sufficient photozone was added to maintain a level of 0.3 to 0.6 mg/l. At 30 minutes and 60 minutes 5 gallon samples were pumped through a 1 micron polypropylene filter and the samples processed as given above.

River Water Control: Subsequent to the trials, a one gallon grab-sample of Poudre River water was inoculated with sufficient sodium thiosulfate to make a 1% solution and 25,000 Giardia cysts from the source material was added.

The following morning the cysts exposed to sodium thiosulfate and the raw Poudre River water were inoculated into 5 Mongolian gerbils at a level of approximately 5,000 cysts per gerbil. An additional 5 Mongolian gerbils were inoculated with the source material used for the trial at about 5,000 cysts per gerbil. An additional 5 gerbils were maintained as uninoculated controls.

#### RESULTS:

The results are presented in Tables 1 and 2. The lag time between inactivation of the photozone and/or chlorine was 20-25 minutes for the 5 and 10 minute

samples in Trial IV; thereafter, lag time was cut to 15 minutes in the 20 minute, 30 minute, and 60 minute samples from Trial IV and all samples in Trials V, VI, and VII. The morphologic quality of cysts in Trial IV were judged excellent at 5, 10, 15, and 20 minutes. At 30 minutes post-exposure, fewer Giardia cysts could be found and these were of poor morphologic quality, indicating that they were dead. The same results were obtained at 60 minutes exposure; however, fewer cysts could be found. In Trial V a considerable number of the Giardia cysts were judged morphologically excellent at 30 minutes exposure, but fewer cysts were present in this sample. At 60 minutes exposure, few cysts could be found and all of these were judged to be of poor morphologic quality. In Trials VI and VII all Giardia cysts found at both the 30 and 60 minute sampling periods were judged to be of excellent morphologic quality.

#### DISCUSSION;

The results of Trial IV indicate that the amount of photozone in combination with chlorine was effective in killing and/or rendering the cysts of Giardia inactive between 20 and 30 minutes post-exposure. In Trial V, the chlorine was eliminated and, as a consequence, three of the five gerbils became infected with Giardia at 30 minutes post-exposure; however, one of these animals had a very light infection. This indicated that photozone alone killed the cysts at sometime between 30 and 60 minutes exposure. The use of photozone at these levels, together with turbidities of 2.6 and 4.6 NTU did not kill many of the Giardia cysts in the absence of chlorine.

The test results are reformatted in Table 3 to assist in an evaluation of alternative Giardia control design concepts. For a photozone concentration of 0.5 - 0.6 mg/l, a free chlorine of 0.21 - 0.58 mg/l, and a turbidity of 0.53 - 0.73 NTU, 30 minutes of treatment time are adequate for the deactivation of

Giardia cysts. If there is no free chlorine, and a turbidity of less than 0.70 NTU, a treatment time of 30 - 60 minutes is required. If shorter treatment times and no free chlorine are desirable, additional photozone is required. If the turbidity exceeds 2.30 NTU, treatment times in excess of 60 minutes of additional photozone are required to control Giardia cysts.

Table 1. Protocol and constants for the photozone trials IV through VII.

Trial #	Temperature (C)	Turbidity (NTU)	Millivolts (ORP)	Chlorine (PPM)	Sample Size
Trial IV					
5	4.1	0.74	710	<0.21	
10	4.1	0.74	720	<0.21	One gallon
20	4.1	0.74	720	<0.21	grab-samples
30	4.1	0.73	730	<0.21	40,000 cysts/gallon
60	4.1	0.72	750	<0.21	
Trial V					
30	4.0	0.75	230	0.00	5 gallon samples through polypropylene filter
60	4.1	0.70	235	0.00	40,000 cysts/gallon
Trial VI					
30	4.5	2.60	325	0.00	Same as Trial V
60	4.5	2.30	360	0.00	
Trial VII					
30	4.6	4.60	320	0.00	5 gallon samples through polypropylene filter with
60	4.6	4.50	370	0.00	80,000 cysts/gallon

Table 2. Results of exposure of gerbils to Giardia cysts exposed to photozone and chlorine.

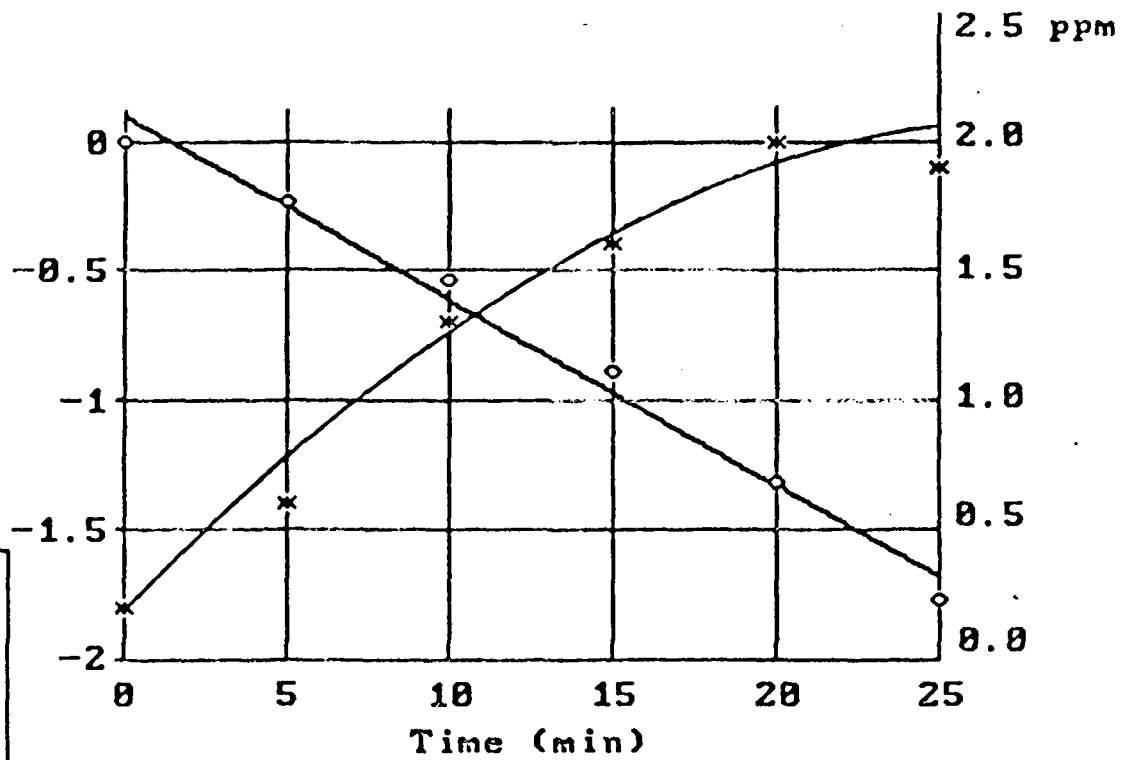
Trial #	# Gerbils Inoculated	# Cysts/ Gerbils	# Gerbils Infected	# Trophozoites at 5 days postinfection
<b>Trial IV</b>				
5	5	5000	5	10-20x10 <sup>6</sup> /Gerbil
10	5	5000	5	10-20x10 <sup>6</sup> /Gerbil
20	5	5000	5	10-20x10 <sup>6</sup> /Gerbil
30	5	5000	0	0
60	5	5000	0	0
<b>Trial V</b>				
30	5	5000	3/5	10-20x10 <sup>6</sup> in 2; <1x10 <sup>6</sup> in 1
60	5	5000	0	0
<b>Trial VI</b>				
30	5	5000	5	20-30x10 <sup>6</sup> /Gerbil
60	5	5000	5	20-30x10 <sup>6</sup> /Gerbil
<b>Trial VII</b>				
30	5	5000	5	50-70x10 <sup>6</sup> /Gerbil
60	5	5000	5	50-70x10 <sup>6</sup> /Gerbil
River water	5	5000	5	50-70x10 <sup>6</sup> /Gerbil
Positive controls	5	5000	5	50-70x10 <sup>6</sup> /Gerbil
Negative controls (uninoculated)	5	0	0	0

Table 3. Summary of Test Conditions and Giardia Deactivation

Test	Treat Time (min)	Free Chlorine			Temp (C)	pH	Giardia		Deactivation
		Turbidity (NTU)	(mg/l)	ORP (mV)			Raw Water (Cysts/gal)	Innocation (Cysts/Gerbil)	
IV-5	5	0.74	<0.21	710	4.1	7.72	40,000	5,000	Minor
IV-10	10	0.74	<0.21	720	4.1	7.71	40,000	5,000	Minor
IV-20	20	0.74	<0.21	720	4.1	7.70	40,000	5,000	Minor
V-30	30	0.75	0.00	230	4.0	7.38	40,000	5,000	Partial
IV-30	30	0.73	<0.21	730	4.1	7.71	40,000	5,000	Complete
III-30	30	0.53	<0.21	820	3.3	8.81	10,000	--	Complete
II-30	30	0.57	<0.40	875	4.1	7.68	10,000	--	Complete
I-30	30	0.55	<0.58	875	0.2	7.72	10,000	--	Complete
VI-30	30	2.60	0.00	325	4.5	7.65	40,000	5,000	Minor
VII-30	30	4.60	0.00	320	4.6	7.75	80,000	5,000	Minor
V-60	60	0.70	0.00	235	4.1	7.70	40,000	5,000	Complete
IV-60	60	0.72	<0.21	750	4.1	7.68	40,000	5,000	Complete
VI-60	60	2.30	0.00	360	4.5	7.71	40,000	5,000	Minor
VII-60	60	4.50	0.00	370	4.6	7.75	80,000	5,000	Minor
I-120	120	0.63	<0.21	880	1.6	7.64	10,000	--	Complete
II-120	120	0.52	<0.21	885	4.2	7.70	10,000	--	Complete
III-120	120	0.66	<0.26	850	3.3	8.10	10,000	--	Complete



$\ln (TCE/TCE_0)$



# Drinking-water treatment with ozone

*Ozone is a powerful disinfectant and oxidant,  
but its chemical byproducts need to be better understood*



---

William H. Glaze  
*University of California, Los Angeles  
Los Angeles, Calif. 90024*

---

Ozone came into use as a drinking-water disinfectant as early as 1906 at the Bon Voyage plant in Nice, France; since then, more than 1000 facilities throughout Europe have adopted the practice (1). Some use ozone as the primary or sole disinfectant; others use it as an oxidant for the control of flora, odor, and color and to reduce the manganese and iron content of drinking water. Lately, engineers at European plants are finding that preozonation enhances the flocculation of suspended particles in surface waters, and its use for this purpose is expanding.

The use of ozone in North America, however, has only recently begun to gain acceptance. According to Rice, the number of ozonation plants in the United States has increased from five in 1977 to 20 in 1984 (1). During the same period, the number of plants in Canada increased from 23 to nearly 50. Large plants are beginning operations this year in Los Angeles and in Hackensack, N.J.; one plant is scheduled to open in Myrtle Beach, S.C., in 1988 (Table 1). The Los Angeles plant contains one of the largest ozone production facilities in the world.

One major factor in the increased interest in ozone is the need to decrease the use of free chlorine in water treatment in keeping with legislated maximum contaminant levels (MCLs) for trihalomethanes (THMs). For many years, free chlorine has been the disinfectant of choice in North America. Chlorine is not only a disinfectant, it is a powerful oxidant. Unfortunately, chlorine also produces byproducts, such as THMs, that can be harmful to human health. The need for THM control has forced water utilities to search for appropriate substitutes.

Water treatment by chloramination (the combination of free chlorine and

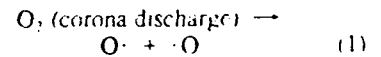
ammonia) has emerged as the most popular alternative disinfection process because chloramines do not form THMs. Chloramines are weak oxidants, however, so stronger oxidants, particularly ozone and chlorine dioxide, are being considered as substitutes for chlorine at the beginning and middle of the treatment process.

Ozone is gaining in popularity for other reasons as well. In tests in which ozone has been compared with chlorine, ozone has been shown to be superior to chlorine as a coagulant (2). It also appears to form much smaller amounts of mutagens than either chlorine or chlorine dioxide do (3). In addition,

when ozone decomposes it generates radical intermediates that have much greater oxidizing power than ozone itself does. The use of chemical oxidants to disinfect water is shown schematically in Figure 1

### Ozone generation

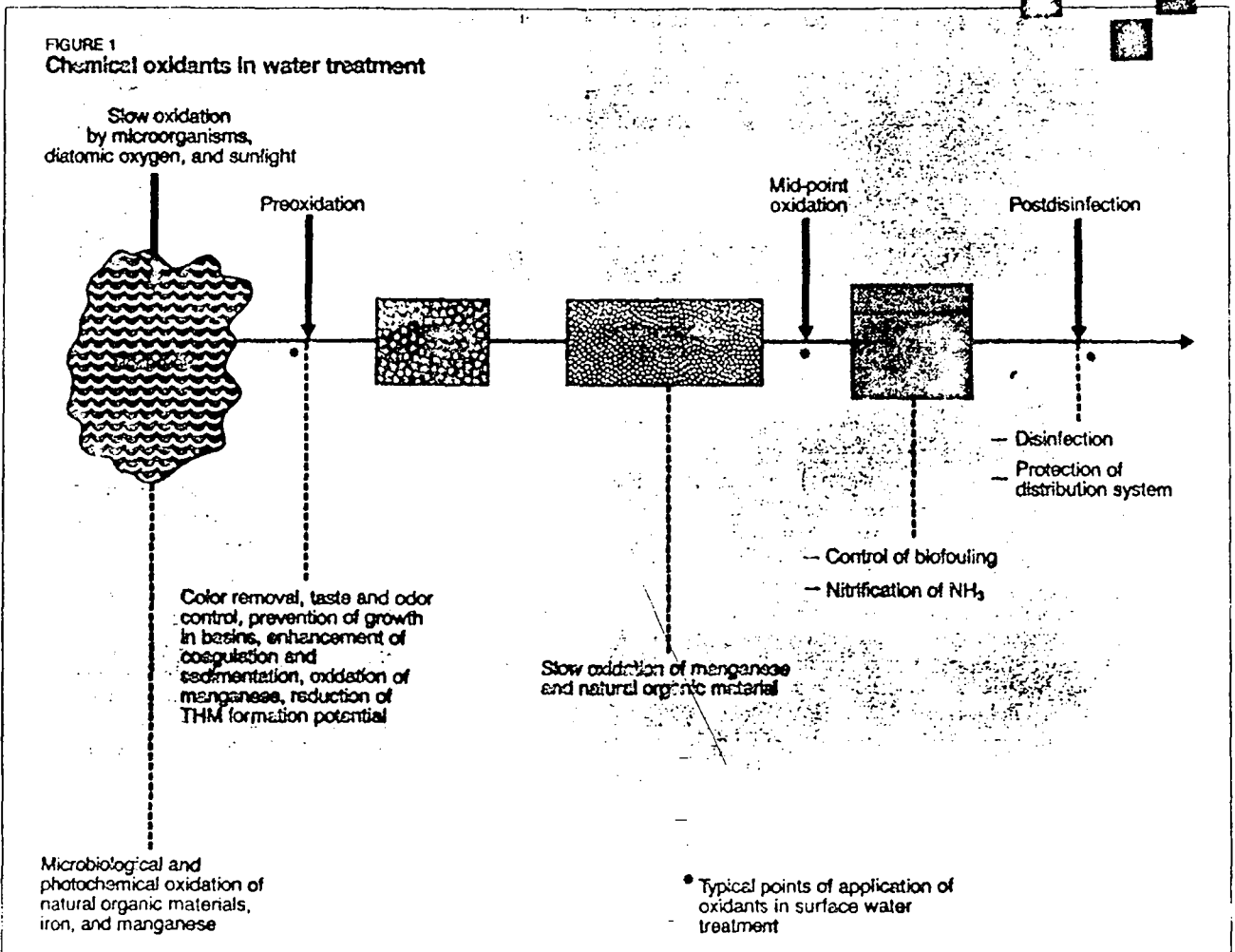
Because ozone is an unstable gas, it must be generated where it will be used. The most common technique for generating ozone is the cold plasma discharge method, in which ozone is formed by decomposition of diatomic oxygen:

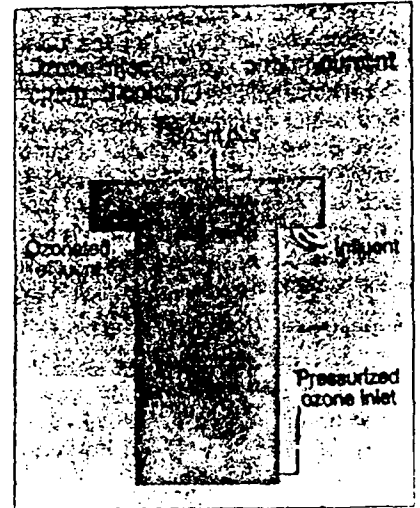
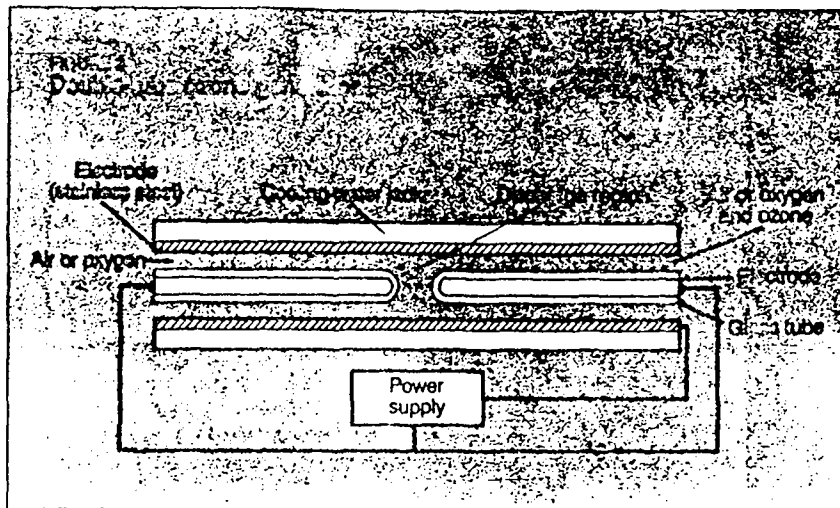


**TABLE 1**  
**Operating Ozone Generation Plants**

Location	Capacity (kg/day)	Primary Use
Los Angeles	27.3	Coagulation and THM control
Myrtle Beach, S.C.	1.4	Color removal, THM control
*Under design, scheduled for completion 1988.		

Figure 2 is a double tube ozone-generating unit commonly found in large-scale applications. Large-scale generators can contain as many as 400 double tubes, and they can generate 600 kg/day of ozone when dry oxygen is the feed gas. With air, the yield of ozone is about 50% of that generated with oxygen. In both cases the feed gas must be oil free and have a low dew point (-52 °C to -58 °C). Recent advances in ozone generation by the cold plasma





method, which have been reviewed by Coste and Fiessinger (4), include the development of generators that operate in the medium frequency range (600 Hz); modifications in the design of the tubes, particularly the use of ceramic rather than glass dielectrics; and improved electronic systems for controlling current.

Ozone also can be generated by means of ultraviolet (UV) light (less than 200 nm) generated by arc discharge lamps, in much the same manner as ozone is formed in the upper atmosphere (Equations 1 and 2). Although photochemical units cannot generate ozone at concentrations as high as those produced by cold plasma generators, UV generators may be competitive for small-scale systems because they require little capital investment and are relatively easy to maintain.

#### Transfer of ozone into water

Ozone produced by the cold plasma discharge method is present in air or oxygen at concentrations of 1-3% and 3-7%, respectively. These values correspond to 11-90 g ozone per standard cubic meter of air or oxygen. A number of devices have been used to transfer ozone into water; the most popular is the counter-current sparged column (Figure 3). Other systems include the stirred-tank reactor with diffuser, methods that increase mass transfer through a combination of small bubble size and hydrostatic pressure, and the in-line static mixer.

In the absence of chemical reactions, mass transfer from the gas phase to the aqueous phase can be described by Equation 3:

$$\frac{dC}{dt} = k_1 a (C^* - C) = k_1 a (P/H - C) \quad (3)$$

in which  $C$  is the concentration of ozone in the liquid phase,  $C^*$  is the liquid-phase concentration in equilibrium

with the concentration of ozone in the gas phase,  $P$  is the partial pressure of ozone in the gas phase,  $H$  is the Henry's law constant for ozone (0.082 atm m<sup>3</sup> g·mol<sup>-1</sup> at 25 °C), and  $k_1 a$  is the overall transfer coefficient. The upper curve in Figure 4 is a plot of ozone concentration in the aqueous phase in a static reactor as ozone-containing gas is introduced. The initial slope of the line is related to  $k_1 a$ , which is assumed to be 0.36 g·mol<sup>-1</sup> min<sup>-1</sup> in this case.

Under actual conditions in a treatment plant, chemical reactions in the liquid phase consume ozone. Thus, Equation 3 must be modified to account for the loss of ozone by the following chemical pathways:

$$\frac{dC}{dt} = k_1 a (P/H - C) - k_2 (C)(HO^-) - k_3 (S_i)(C) \quad (4)$$

Here,  $k_2$  is the rate constant for the decomposition of ozone and the term on the extreme right is the sum of all the rate terms for chemical reactions that involve substrates ( $S_i$ ) in the water that consume ozone.

The lower curve in Figure 4 is a plot of the mass transfer of ozone into the reactor. It takes into account only the middle term in Equation 4 (autodecomposition of ozone). A rate constant of 70 M<sup>-1</sup> s<sup>-1</sup> is assumed (5). Rapid reactions in the liquid phase will drive ozone dissolution; that is, the faster ozone is consumed in the liquid phase, the faster it will cross the gas-water boundary. This is likely to be significant to the design of reactors that are based on the rapid decomposition of ozone into radicals.

#### Drinking-water treatment

**Ozone as a disinfectant.** Ozone suffers from two major limitations as an alternative to chlorine. First, it is unstable in water; it decomposes to oxygen at a rate proportional to the pH of the water. For example, at pH 8, which is

typical of many drinking-water supplies, its half-life is less than one hour, too short to ensure that a residual disinfectant capacity will remain at the far reaches of a large distribution system. Despite its short lifetime, however, ozone is particularly effective against recalcitrant microorganisms. It is more effective than is chlorine for removal of *Giardia* (an organism that causes a gastrointestinal disease), viruses, and certain forms of algae (6).

Second, ozone reacts with natural organic substances to produce low-molecular-weight oxygenated byproducts that generally are more biodegradable than their precursors are. These substances will promote biological growth in a distribution system ("regrowth"), further limiting the disinfection efficacy of ozone. For these reasons, ozone should be used in combination with other disinfectants that maintain an active residual for longer periods, and it should be combined with some method of filtration for removing biodegradable material.

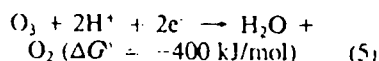
**Ozone as an oxidant.** Ozone can oxidize many nuisance compounds or potential toxicants in water supplies. These include natural color bodies, some compounds that produce unpleasant tastes or odors, manganese(II) and iron(II), and phenolic materials. Ozone also coagulates natural water constituents. For these reasons, ozone has been adopted as the preoxidant in the new Los Angeles treatment facility, where pilot studies have shown that preozonation substantially improves the filtration of the raw water, thereby reducing the need for other chemical coagulants and allowing shorter basin and filter contact times (2, 7). Comparison tests have shown that ozone is substantially superior to chlorine for these purposes.

Although the mechanism of coagulation by ozone is not clear, several possibilities have been suggested. One possi-

bility is the oxidation of metal ions to yield insoluble forms such as Fe(III). Another is oxidation of humic material to form more polar or chelating groups, which induce coagulation. Finally, oxidative dissociation of natural organic material from colloidal clay particles, which destabilizes the colloids, has been suggested. Further research is under way, and more information should be forthcoming (8).

#### Chemistry of ozone

In referring to ozone as an oxidant, chemists often cite the very high negative value of the thermodynamic free energy of reactions, as set forth in Equation 5:



in which  $\Delta G^\circ$  is the free energy. Although this very large negative value defines the *potential* for ozone to act as an oxidant, the usefulness of ozone in water treatment is limited by the *kinetics* of its reactions.

In some cases the kinetics are favorable enough to make ozone a practical oxidant, but this is not generally the case. When ozone reacts with typical water contaminants, rate constants can vary by more than eight orders of magnitude ranging from  $10^7 \text{ M}^{-1} \text{ s}^{-1}$  for the phenolate anion to  $10^{-1} \text{ M}^{-1} \text{ s}^{-1}$  for tetrachloroethylene (9, 10).

Ozone reacts best when it can act as an electron transfer acceptor (for the oxidation of metal ions), as an electrophile (for the oxidation of phenol and other activated aromatics), and as a dipole addition reagent (by addition to carbon-carbon multiple bonds). The rates of oxidation of organic compounds by ozone are severely depressed, however, by electron-withdrawing substituents. For example, ozone reacts poorly with most aliphatic organic halides, such as chloroform.

Ozone also does not react with aliphatic compounds other than those that have easily oxidized groups, such as aldehydes and ketones. Moreover, ozone is not a good oxidant for most specific organic materials in water treatment. Rice has, however, pointed out several exceptions: Ozone has been used to oxidize sulfides, nitrites (to nitrate), cyanides (to cyanate), and some detergents and pesticides (11).

**The radical chemistry of ozone.** Recent studies from several laboratories support the application of ozone as a chemical oxidant for water and wastewater treatment. Basic research has shown that ozone decomposes by a complex mechanism that involves the generation of hydroxyl radicals, which are among the most reactive oxidizing species (Table 2). Other studies have

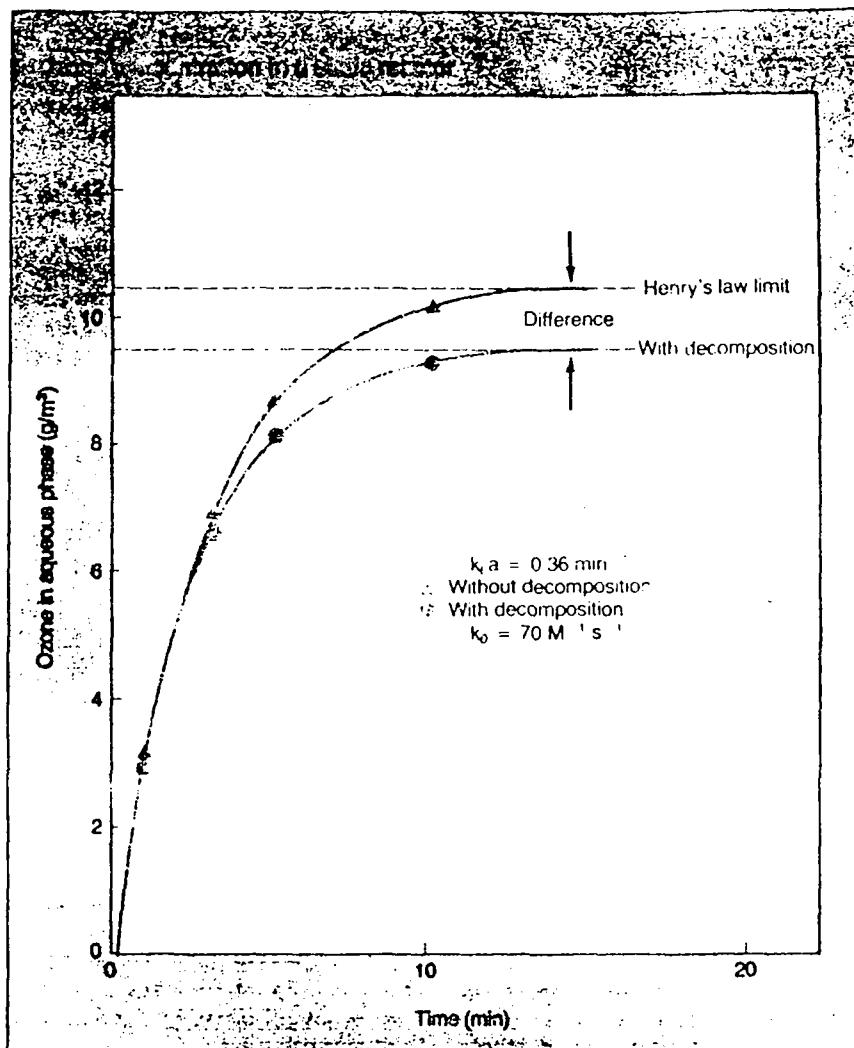


TABLE 2  
Reaction rate constants for oxidized organic materials

Compound	Rate constants ( $\text{M}^{-1} \text{ s}^{-1}$ )	
	Ozone	Hydroxyl radical
Benzene	2	$8 \times 10^6$
Chlorobenzene	0.6	$6 \times 10^6$
Methanol	0.02	$0.9 \times 10^6$
Carbon tetrachloride		$0.2 \times 10^6$

Sources: References 9, 10, 17, and 19.

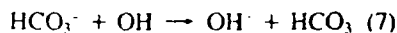
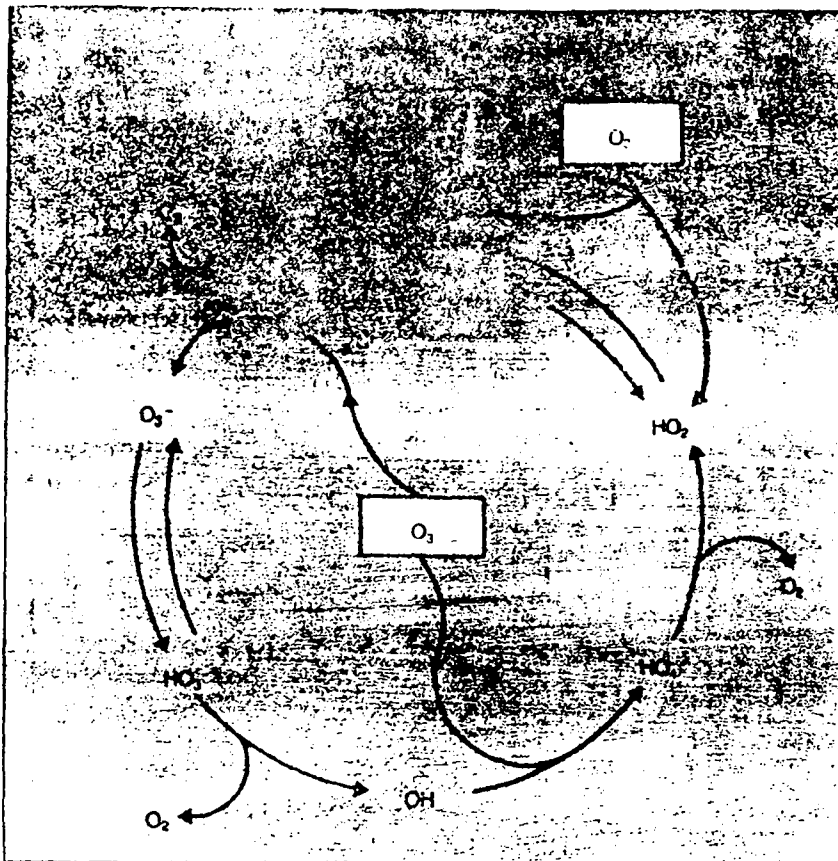
involved ozone and some other agent or process, such as UV radiation, hydrogen peroxide, or ultrasound, to develop water treatment processes that are substantially more powerful than ozone is alone. These new processes are related chemically to the decomposition mechanisms so elegantly elucidated by Hoigné et al. (5, 12-14) and Forni et al. (15) and anticipated much earlier by Taube and Bray (16).

The decomposition of ozone in pure water is shown in Figure 5 as a cyclic chain mechanism; the overall stoichiometry is shown by Equation 6:



Decomposition can be initiated by hydroxide ions, formate ions, or a variety of other species, and in pure water the chains are very long (17). A single initiation step can cause the decomposition of hundreds of molecules of ozone before the chain ends. Ozone is unstable at high pH values because the decomposition process is initiated by hydroxide ions.

In the presence of the usual water contaminants, such as bicarbonate ions and natural organic matter, the cyclic chain shown in Figure 5 can be broken. In the case of bicarbonate, the reaction (Equation 7) is a simple electron transfer process with the hydroxyl radical:



The net effect is to retard the decomposition of ozone. Hoigné and co-workers have shown that increasing the carbonate ion concentration from 10 g/m<sup>3</sup> to 100 g/m<sup>3</sup> in phosphate-buffered water will approximately double the half-life of ozone at pH 8 (5).

**Ozone and natural organic matter.** When natural organic materials are present, ozone decomposition is accelerated, and the chemistry becomes more complex. There are several reactions that can occur when ozone is added to natural waters:

- Free or complexed metal ions can be oxidized, possibly by one-electron transfer processes, to yield the ozonide radical anion, which can then initiate the chain decomposition of ozone (17).
- The hydroxyl radical can react with aromatic groups in the humic molecules, yielding hydroxylated forms, which are then more susceptible to further attack by ozone (18).
- The hydroxyl radical can react with aliphatic side chains or fatty acids, usually by hydrogen atom abstraction reactions. The organic radicals formed will generally add dioxygen to form organic peroxides, which decompose by eliminating the superoxide ion. The superoxide ion can then reenter the chain to cause more decomposition of ozone and in-

creased formation of hydroxyl radicals (17, 19).

- Ozone can react with carbon-carbon double bonds in the humic molecule (by the usual pathway [20]), first to yield peroxidic intermediates and then to give hydrogen peroxide and carbonyl products.

**Ozone and synthetic organic substances.** If anthropogenic organic materials are present in water, the same reactions can result in the destruction of these species by ozone, hydroxyl radicals, or both. In general, the hydroxyl radical reacts with organic compounds at rates that essentially are controlled by diffusion; rate constants typically are between 10<sup>7</sup> M<sup>-1</sup> s<sup>-1</sup> and 10<sup>9</sup> M<sup>-1</sup> s<sup>-1</sup> (Table 2).

Thus, it is possible in principle to induce ozone to act according to an entirely different kind of chemistry than it usually shows in nonaqueous solvents. Indeed, in actual water treatment applications ozone probably never acts according to the classical chemistry that one finds in textbooks that describe nonaqueous systems (20, 21). Classical reactions can occur, but there also will be a parallel set of reactions, often interacting with the first, involving the radical intermediates (especially the very reactive hydroxyl radical), as shown in Figure 5. As Stachelin and Hoigné have noted, these radical processes are promoted by the products of the classical reactions, especially the

superoxide ion (17, 19). But they are also promoted by other water contaminants, such as metal ions.

Under practical conditions, the dose of ozone is never enough to satisfy the ultimate demand, and the reactions discussed above generally will stop when the supply is depleted. Typically, this will be long before the organic substances have become mineralized to carbon dioxide.

#### Catalytic ozonation processes

Ozone can be combined with other processes or agents for more effective water and wastewater treatment than is possible by ozonation alone:

- radiation (22-25).
- ultrasound (26).
- hydrogen peroxide (27, 28), or
- metallic catalysts, such as reduced iron (29).

Each of these processes probably involves chemistry similar to that discussed by Hoigné et al. for the base-catalyzed decomposition of ozone (5, 13, 14). Hoigné has identified the hydrogen peroxide anion HO<sub>2</sub><sup>-</sup> as one of the species that can initiate the cyclic chain process shown in Figure 5. This apparently accounts for observations that hydrogen peroxide increases the effectiveness of ozone for removal of organic substances during water treatment (27, 28, 30).

Peyton and Glaze (25, 31) have verified the earlier work of Taube (32), who showed that the UV photolysis of ozone in water yields hydrogen peroxide rather than two hydroxyl radicals, as occurs in wet air. Thus, the ozone-UV process resembles the ozone-peroxide process but offers the additional advantage that direct photolysis and photosynthesized processes also occur to decompose organic substrates.

These ozonation processes are attracting increasing attention because of their ability to destroy organic substances in water. Figure 6 illustrates the destruction of several chlorinated organic contaminants by ozone with and without UV radiation. (The loss of chloroform [CHCl<sub>3</sub>] and dichlorobromomethane [CHCl<sub>2</sub>Br] is caused by sparging, not by direct reaction with ozone.) In general, UV exposure accelerates the decomposition of these substances, although the decay of hexachlorobiphenyl (HCB) is retarded.

Trials of these processes now in progress or in planning stages aim at applying them to the renovation of ground-water contaminated with synthetic organic compounds. The advantage is that these processes destroy the contaminants instead of transferring them to another phase, as do air stripping, granular activated carbon (GAC) adsorption, and reverse osmosis. The

commercial feasibility of these processes is still uncertain.

### Health effects studies

Several studies have attempted to determine the compounds formed by ozonation alone and in combination with other processes in natural waters. Most of these studies have yielded no surprises. Aldehydes, carboxylic acids, and other aliphatic, aromatic, and mixed oxidized forms have been observed. None appear to cause significant toxic effects at the concentrations expected in ozonated waters (33).

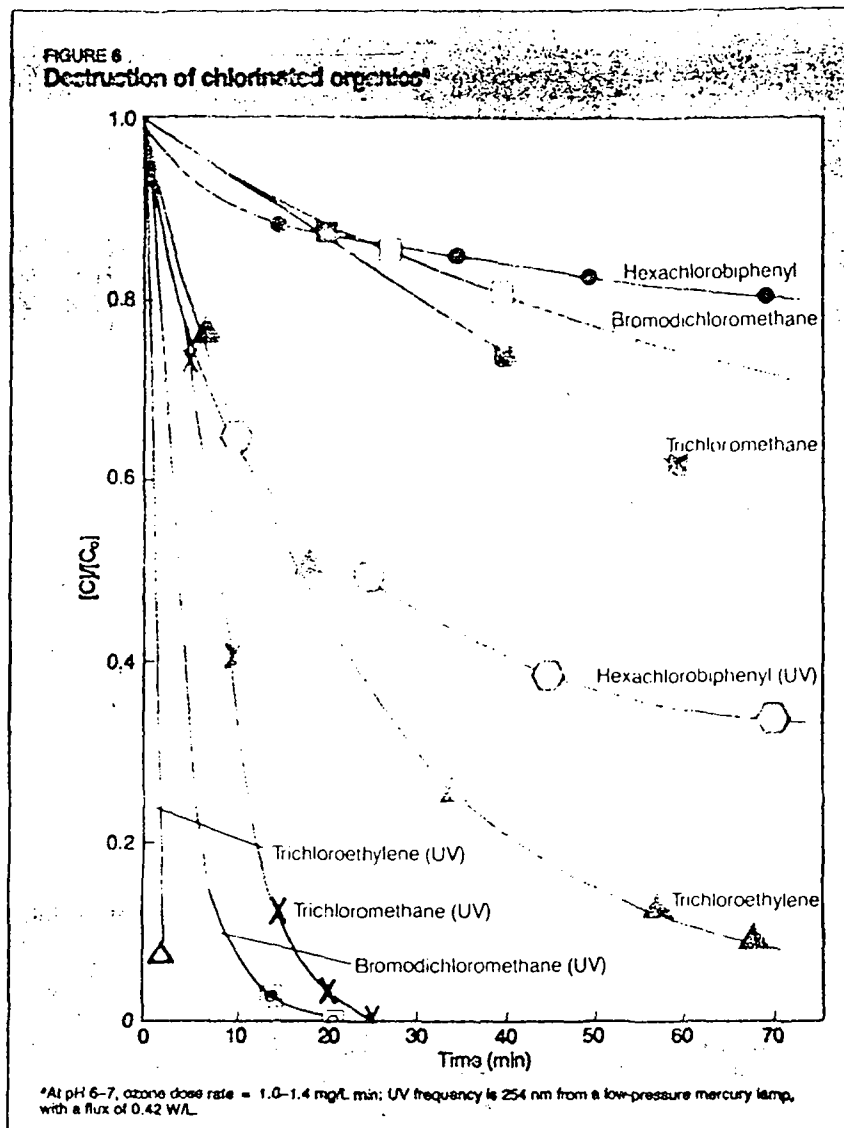
Most bioassay screening studies have shown that ozonated water induces substantially less mutagenic activity than chlorinated water does. One study showed that ozonation decreased mutagenic activity in Rhine River water, whereas the activity increased after the water was treated with chlorine and chlorine dioxide (3). These studies do not necessarily remove all concern about the safety of ozonation for drinking-water treatment. There may very well be byproducts formed that harm human health; they simply have not yet been found. It is instructive to recall that chlorine was used for decades before THMs were discovered in drinking water. The situation with ozone byproducts may be analogous.

All of the health effects studies carried out so far have used preconcentration techniques that may cause some byproducts to decompose during work-up. These byproducts include peroxides, epoxides, and conjugated unsaturated aldehydes. Further research is needed if ozonation is to be adopted on a large scale in the United States.

### Ozone and biological treatment

The byproducts formed by oxidation with ozone and catalytic ozonation processes are generally more amenable than are those formed by chlorination processes to removal by biological treatment processes—that is, they are more biodegradable than their precursors are. This is a disadvantage if ozone is to be used as a terminal disinfectant. If applied before filtration, however, ozone can promote biological activity in the filter that will remove organic matter and THM precursors; in the final step, the water can be treated with chlorine or another disinfectant.

Ozonation in advance of filtration with GAC has been called the biological activated carbon process. This combination of processes has been studied in Western Europe (34-36), where it was pioneered, and in North America (37-38). DiGiano recently reviewed the subject and concluded that the combination of preozonation and GAC filtration removes organic substances but



that the effect is not as dramatic as some of its proponents claim (39). Nonetheless, there are several treatment plants in Europe that are using the ozone-GAC process, and active removal well beyond the period of GAC exhaustion is reported (36). It is possible that the use of catalytic oxidation processes will increase biodegradability even more than ozone can alone.

### Ozone system costs

Although ozone systems are capital intensive, they offer significant economies of scale. Costs of generating and contacting systems vary from one site to another, but about \$2400/kg of ozone/day is a plausible figure for a plant producing 900 kg/day of ozone. This would be enough to treat 100 million gal/day of water (4.4 m<sup>3</sup>/s) with an ozone dose of 2 g/m<sup>3</sup> (2 ppm) and would require a capital investment of approximately \$2 million. Capital costs for systems generating 0-5 kg/h of ozone are about three times those that generate more than 50 kg/h.

Operating costs of ozone plants also vary, but a range of \$0.001-\$0.002/m<sup>3</sup> seems to be typical of most plants in the United States. Ozone production is energy intensive and requires 16 kWh/kg and 24 kWh/kg of ozone for oxygen- and air-fed systems, respectively. Total treatment costs for ozonation are in the range of \$0.04/m<sup>3</sup> to \$0.06/m<sup>3</sup> of water for plants that process 10 million-gal/day and 100 million-gal/day (0.44 m<sup>3</sup>/s and 4.4 m<sup>3</sup>/s), respectively, assuming an ozone dose of 1 ppm.

### For the future

It is likely that the use of ozone in water treatment will increase substantially in North America. In the near future, its principal application is likely to be similar to the new Los Angeles plant, where ozone is used a coagulant aid. Ozonation also will find new applications as a substitute for prechlorination for control of biofouling, taste and odor control, and manganese removal, particularly if the maximum contaminant levels for THMs are lowered.

The control of THM precursors, groundwater chloroorganics, and other synthetic organic materials by ozonation is not likely to be successful. Advanced catalytic ozonation processes, however, are showing promise for such applications and will be studied more thoroughly.

As the use of ozone for drinking-water treatment increases, particular attention will have to be paid to the use of appropriate analytical methods and separation procedures that will give an accurate representation of the substances present after oxidation—not just those that survive the work-up procedures. Of the byproducts of particular interest, unsaturated aldehydes, epoxides, and peroxides are the most likely to cause harm.

As advanced oxidation processes are evaluated further, it is possible that new ozone contacting systems will emerge to take advantage of the inherent rapid mass transfer and chemical reaction rates of radical processes. New designs that combine ozone generation with ozone, UV, and peroxide injection may emerge as the best commercial prospects for advanced oxidation processes in water and wastewater treatment.

#### References

- (1) Rice, R. G. In *Safe Drinking Water: The Impact of Chemicals on a Limited Resource*; Rice, R. G., Ed.; Lewis Publishers: 1985; pp. 123-59.
- (2) Prendiville, P. W. *Ozone Sci. Eng.* 1986, 8, 77-93.
- (3) Zoeteman, B. C. et al. *Environ. Health Perspect.* 1982, 46, 197-205.
- (4) Coste, C.; Fiessinger, F. In *AWWA Proceedings, Ozonation: Recent Advances and Research Needs*; American Water Works Association: Denver, in press.
- (5) Staehelin, J.; Hoigné, J. *Environ. Sci. Technol.* 1982, 16, 676-81.
- (6) Sproul, O. J. In *AWWA Proceedings, Ozonation: Recent Advances and Research Needs*; American Water Works Association: Denver, in press.
- (7) Monk, R. D. G. et al. *J. Am. Water Works Assoc.* 1985, 77, 49-54.
- (8) Reckow, D. A. In *AWWA Proceedings, Ozonation: Recent Advances and Research Needs*; American Water Works Association: Denver, in press.
- (9) Hoigné, J.; Bader, H. *Water Res.* 1983, 17, 173-83.
- (10) Hoigné, J.; Bader, H. *Water Res.* 1983, 17, 185-94.
- (11) Rice, R. G. In *AWWA Proceedings, Ozonation: Recent Advances and Research Needs*; American Water Works Association: Denver, in press.
- (12) Staehelin, J.; Hoigné, J. *Environ. Sci. Technol.* 1982, 16, 17-22.
- (13) Buhler, R. E.; Staehelin, J.; Hoigné, J. *J. Phys. Chem.* 1984, 88, 2560-64.
- (14) Staehelin, J.; Buhler, R. E.; Hoigné, J. *J. Phys. Chem.* 1984, 88, 5999-6004.
- (15) Forni, L.; Bahnemann, D.; Hart, E. J. *J. Phys. Chem.* 1982, 86, 255-59.
- (16) Taube, H.; Bray, W. C. *J. Am. Chem. Soc.* 1940, 62, 3357-73.
- (17) Staehelin, J.; Hoigné, J. *Vom Wasser* 1983, 61, 337-48.
- (18) Guroi, M. D.; Singer, P. C. *Water Res.* 1983, 17, 1173-81.
- (19) Staehelin, J.; Hoigné, J. *Environ. Sci. Technol.* 1985, 19, 1206-13.
- (20) Bailey, P. S. In *Ozonation in Organic Chemistry, Vol. I, Olefinic Compounds*; Academic Press: New York, 1978; pp. 15-37.
- (21) Bailey, P. S. In *Ozonation in Organic Chemistry, Vol. II, Nonolefinic Compounds*; Academic Press: New York, 1982; pp. 18-42; 371-422.
- (22) Garrison, R. L.; Mauk, C. E.; Prengle, H. W., Jr. In *First International Symposium on Ozone for Water and Wastewater Treatment*; Rice, G. G.; Browning, M. E., Eds.; International Ozone Association: Vienna, Va., 1975; pp. 551-77.
- (23) Peyton, G. R. et al. *Environ. Sci. Technol.* 1982, 16, 448-53.
- (24) Glaze, W. H. et al. *Environ. Sci. Technol.* 1982, 16, 454-58.
- (25) Peyton, G. R.; Glaze, W. H. In *Photochemistry of Environmental Aquatic Systems*; Zika, R. G.; Cooper, W. J., Eds.; ACS Symposium Series 327; American Chemical Society: Washington, D. C., 1986; pp. 76-88.
- (26) Sierka, R. A.; Amy, G. L. *Ozone Sci. Eng.* 1985, 7, 47-62.
- (27) Nakayama, S. et al. *Ozone Sci. Eng.* 1979, 1, 119-31.
- (28) Duguet, J. P. et al. *Ozone Sci. Eng.* 1985, 7, 241-58.
- (29) Chen, J. W. et al. *AIChE Symp. Ser.* 1977, 73, 206.
- (30) Brunet, R.; Bourbigot, M. M.; Dore, M. *Ozone Sci. Eng.* 1984, 6, 163-83.
- (31) Glaze, W. H. et al. "Pilot Scale Evaluation of Photolytic Ozonation for Trihalo methane Precursor Removal." Report of Cooperative Agreement CR-808825; EPA-600/52-84-136. NTIS PB84-234517; Municipal Environmental Research Laboratory, EPA, Cincinnati, 1984.
- (32) Taube, H. *Trans. Faraday Soc.* 1957, 53, 656.
- (33) Glaze, W. H. *Environ. Health Perspect.* 1986, 69, 151-57.
- (34) Sontheimer, H. *Translations of Reports on Special Problems of Water Treatment—Vol. 9, Adsorption*, EPA-600/9-76-030; Municipal Environmental Research Laboratory, EPA: Cincinnati, 1975.
- (35) Eberhardt, M. N.; Madsen, S.; Sontheimer, H. "Untersuchungen zur Verwendung Biologisch Arbeitender Aktivkohlefilter bei der Trinkwasseraufbereitung." Report 7; Engler-Bunte-Institut, Karlsruhe University, Karlsruhe, West Germany, 1974.
- (36) Rice, R. G. et al. "Biological Processes in the Treatment of Municipal Water Supplies." EPA-600/2-80-1980; Municipal Environmental Research Laboratory, EPA, Cincinnati, 1980.
- (37) Glaze, W. H.; Wallace, J. L. *J. Am. Water Works Assoc.* 1984, 76, 68-75.
- (38) Maloney, S. W. et al. *J. Am. Water Works Assoc.* 1985, 77, 66-73.
- (39) DiGiano, F. In *AWWA Proceedings, Ozonation: Recent Advances and Research Needs*; American Water Works Association: Denver, in press.



William H. Glaze is professor of public health and director of the Environmental Science and Engineering Program at UCLA. He is a principal investigator for projects concerning catalytic ozonation water treatment processes, among other areas.



77V

ORGANIZACION PANAMERICANA DE LA SALUD

-OPS-

UNIDAD EJECUTORA DEL PROGRAMA DE ACUEDUCTOS RURALES

-UNEPAR-

DESINFECCION CON GASES OXIDANTES

PROYECTO MOGGOD

REGION ORIENTAL UNEPAR, GUATEMALA  
ING. JOSE GILBERTO GONZALEZ DE LEON

## 1. ANTECEDENTES.

El presente estudio se desarrolló bajo los lineamientos del "PROYECTO DE COOPERACION TECNICA PARA LA EJECUCION DE UN PROYECTO DE DEMOSTRACION DE MEJORAMIENTO DE LA DESINFECCION DE SISTEMAS DE AGUA POTABLE DE PEQUEÑAS COMUNIDADES Y PUEBLOS A TRAVES DEL MOGGOD".

Dicha acción se debe a la promoción que la Organización Panamericana de la Salud, OPS, ha venido desarrollando para el uso de tecnología apropiada para la desinfección del agua en comunidades pequeñas.

Dentro de esta política, OPS y CEPIS, han patrocinado diversas investigaciones en el campo de la desinfección del agua. Una de ellas indica al momento que los gases oxidantes in situ (MOGGOD), parece ser una de las tecnologías con más perspectivas de ser empleada.

Diversas experiencias se han realizado con la desinfección MOGGOD y en diversos países, hasta que en septiembre de 1987 se realizó un convenio entre el Gobierno de Guatemala, representado por el Instituto de Fomento Municipal INFOM y la Unidad Ejecutora del Programa de Acueductos Rurales UNEPAR, la Organización Panamericana de la Salud a través del Programa de Salud Ambiental y el Programa de las Naciones Unidas para el Desarrollo, celebraron el convenio del proyecto mencionado al inicio, con los siguientes aspectos:

### 1.1 CONSIDERANDOS:

- Que el PNUD ha aprobado la propuesta de Proyecto de Demostración de Mejoramiento de la Desinfección de Sistemas de Agua Potable de Pequeñas Comunidades y Pueblos a través del MOGGOD y ha proporcionado fondos iniciales para acciones preparativas de la OPS/HPE en los países colaborantes.
- Que la inadecuada desinfección de agua potable es un problema de salud pública muy serio.
- Que el MOGGOD tiene buen potencial para evitar o disminuir restricciones existentes contra desinfección de agua potable.
- Que el Gobierno y OPS/HPE tienen interés en la exploración de posibilidades de la fabricación del MOGGOD en el país.
- Que el Gobierno y OPS/HPE tienen interés en el desarrollo de la tecnología del MOGGOD en el contexto del país.

- Que el país tiene la capacidad tecnológica para instalar, operar, monitorear, analizar, evaluar el MOGGOD, tecnología y dispositivos y hacer recomendaciones para mejorar el MOGGOD.

Derivados de los Considerandos, se determinaron claramente las responsabilidades de la OPS y del INFOM-UNEPAR, las cuales se detallan a continuación:

### 1.2 RESPONSABILIDADES DE LA OPS:

- Comprar 2 unidades del dispositivo MOGGOD y repuestos esenciales y entregar dos unidades al Instituto de Fomento Municipal (INFOM) y una unidad a la Unidad Ejecutora del Programa de Acueductos Rurales (UNEPAR).
- Proporcionar a la agencia colaborante las instrucciones para la instalación del MOGGOD.
- Preparar y entregar manuales de operación y mantenimiento del MOGGOD en español.
- Colaborar técnicamente con las agencias/instituciones apropiadas en los asuntos técnicos del MOGGOD relativos a su instalación, operación, mantenimiento, vigilancia, demostración y desarrollo.
- Proporcionar material para educación de los ingenieros y operadores.
- Establecer con las agencias colaborantes el protocolo para monitorear la eficiencia, efectividad, durabilidad, costos, consumo de sal y electricidad.
- Establecer con la agencia colaborante los protocolos para monitorear el nivel de desinfectante y determinar la duración del desinfectante residual.
- Recolectar y analizar la información y datos generados por todas las agencias y países e intercambiarlas con todos los participantes.
- Proporcionar criterios de selección de comunidades para participar en este proyecto de demostración.
- Proporcionar ayuda técnica sobre la fabricación local del dispositivo de MOGGOD.

- Diseminar nueva información técnica en relación de las investigaciones actuales y avances científicos de MOGGOD.
- Proporcionar sal común (cloruro de sodio) de pureza adecuada para los dos primeros años de operación de los equipos.

### 1.3 RESPONSABILIDADES DEL INFOM Y DE UNEPAR:

- Seleccionar comunidades apropiadas para participar en este proyecto de demostración bajo los criterios para la selección.
- Obtener compromisos y negociar acuerdos con las comunidades para su participación.
- Instalar los dispositivos MOGGOD de acuerdo con las guías proporcionadas por OPS.
- Recolección y análisis de información y los datos operativos necesarios para determinar los costos y el consumo:
  - a) de la sal,
  - b) de la electricidad,
  - c) del agua para electrólisis, por metro cúbico del agua tratada.
- Determinar la mínima residual práctica para asegurar agua libre de patógenos.
- Determinar las horas requeridas por mes para operación y mantenimiento.
- Determinar en cada sistema la disminución del residual en la red de distribución.
- Monitorear la operación y mantenimiento del MOGGOD.
- Identificar las fuentes de sal y su pureza.
- Formular recomendaciones para mejorar el dispositivo MOGGOD y su instalación así como la operación.
- Hacer recomendaciones sobre la factibilidad de fabricación del MOGGOD en el país.
- Preparar informes trimestrales sobre el progreso del proyecto de demostración.

## 2. OBJETIVOS.

El objetivo principal de este informe es presentar las experiencias, en relación a la desinfección utilizando la "MEZCLA DE GASES OXIDANTES GENERADOS IN SITU".

Ello implicará la relación cuasi cronológica y detalla da de los diferentes pasos que hubo que dar, desde la celebración del convenio hasta el inicio de operación del equipo seleccionado y el seguimiento a que se sometió para controlar las diferentes variables que intervienen en el conjunto de experiencias.

De igual manera previo a la relación, se incluirá una información general que permita ubicar al amable lector, en el contexto en que se desarrolló la investigación preliminar.

## 3. MARCO GEOGRAFICO Y POBLACIONAL.

La República de Guatemala tiene un área de 108,889 Km<sup>2</sup> y se encuentra localizada al norte de la América Central entre 13° 44' y 17° 50' latitud norte y 88° 33' y 92° 13' longitud oeste. La densidad media de población es de 70 habitantes por Km<sup>2</sup>.

En 1986 la República de Guatemala alcanzó una población de 8.195.117 habitantes, con una tasa de crecimiento anual de 2.78 %.

La distribución total de población por sexo se presenta en la gráfica siguiente:

GRAFICA 1  
POBLACION Y PORCENTAJE POR SEXO  
REPUBLICA DE GUATEMALA  
AÑO 1986

SEXO	POBLACION	
	No.	%
TOTAL	8,195,117	100.
MASCULINO	4.143,071	50.6
FEMENINO	4.052,046	49.4

FUENTE: Guatemala en Cifras de Salud, MSP y AS.

La población total se encuentra dispersa en unos 18,640 núcleos de población, de los cuales 98% tiene menos de 2,000 habitantes.

Esos núcleos poblacionales comprenden aproximadamente el 64% de la población total.

La población está dividida en sector urbano y rural. por definición, se entiende por población urbana, la que habita en las 326 cabeceras municipales y la ciudad capital.

#### 4. MARCO INSTITUCIONAL.

UNEPAR, es la Unidad Ejecutora del Programa de Acueductos Rurales. Es una dependencia del Ministerio de Salud Pública y Asistencia Social.

Fue creada en 1975, sustituyendo al Departamento de Ingeniería Sanitaria de la División de Saneamiento Ambiental. Opera a nivel de Dirección, dependiendo directamente del Ministerio de Salud Pública y Asistencia Social.

Como objetivo fundamental UNEPAR tiene el proveer agua potable al sector de la población rural; trabajando con los "Comités Oficiales de Agua Potable", quienes se convierten en el enlace dinámico entre la institución y las comunidades.

UNEPAR atiende todos los departamentos de la República con excepción de El Petén, ejerciendo su acción a través de:

- Dirección y Administración con sede en la ciudad capital.
- Región Central, con sede en la ciudad de Guatemala.
- Región Oriental, con sede en la ciudad de Chiquimula
- Región Norte, con sede en la ciudad de Cobán.
- Región Occidental, con sede en la ciudad de Quetzaltenango.

#### 5. REGION ORIENTAL.

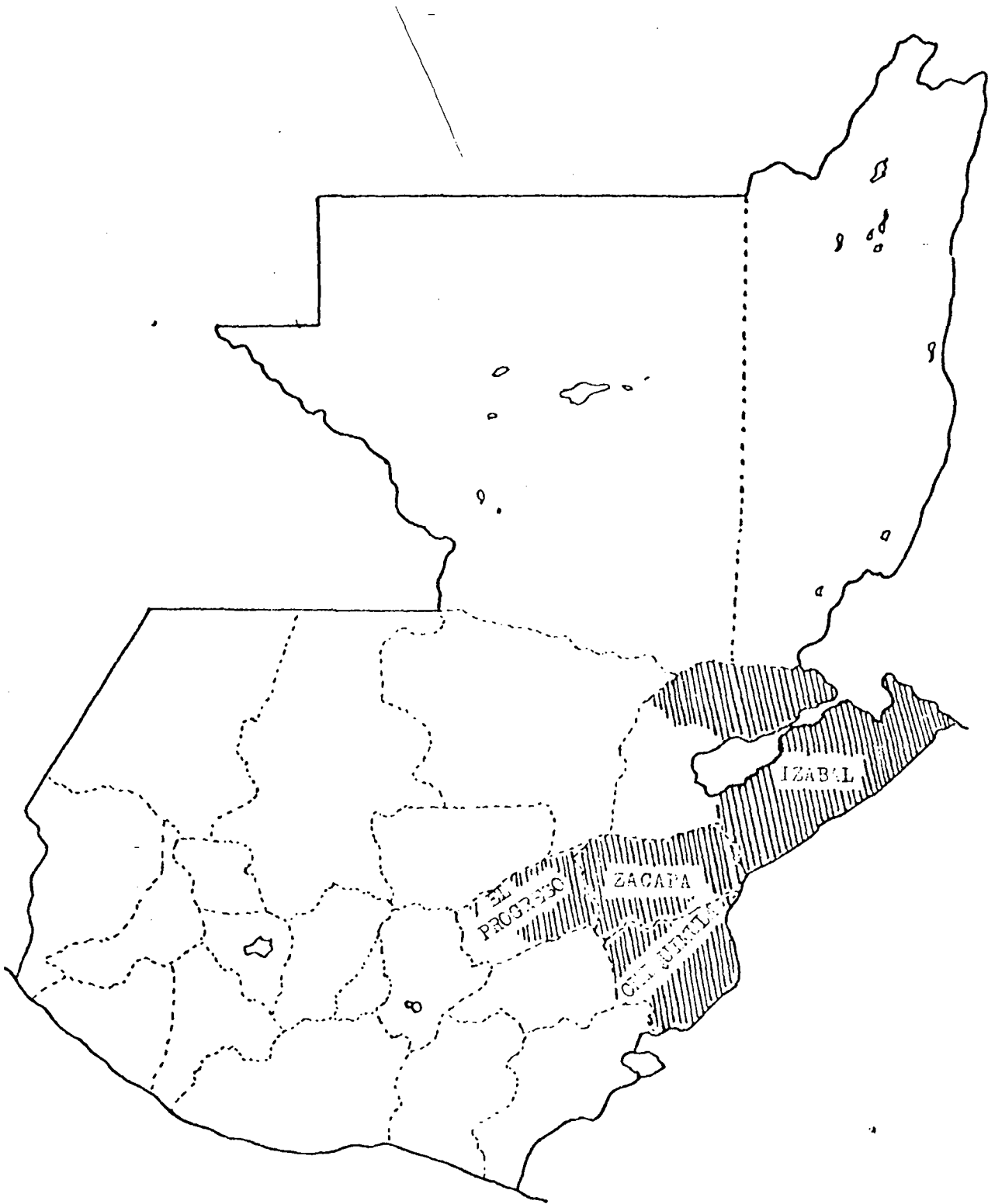
En el presente informe se hará una ampliación sobre esta Región, dado que la Dirección de UNEPAR delegó la responsabilidad de la experiencia del MOGGOD en ella.

##### 5.1 COBERTURA.

La Región Oriental, desarrolla su acción en 4 departamentos de la Zona Nor-Oriental, cubriendo una superficie estimada de 12,530 Km<sup>2</sup>.

La gráfica No. 2 muestra el mapa de la República de Guatemala, con el área de acción de la Región.

GRAFICA No. 2  
REPUBLICA DE GUATEMALA



Un detalle de esa area se presenta en la gráfica No. 3  
 La cobertura de servicios en cada uno de los departamentos se muestra respectivamente así:

- Gráfica No. 4: El Progreso.
- Gráfica No. 5: Zacapa.
- Gráfica No. 6: Chiquimula.
- Gráfica No. 7: Izabal.

La gráfica No. 8 presenta un resumen cuantitativo de a  
tención.

GRAFICA No. 8  
COBERTURA REGION ORIENTAL  
DEPARTAMENTOS - MUNICIPIOS - COMUNIDADES

DEPARTAMENTO	MUNICIPIOS ATENDIDOS	SISTEMAS CONSTRUIDOS	COMUNIDADES BENEFICIADAS
CHIQUIMULA	11	17	31
ZACAPA	10	14	33
IZABAL	4	25	40
EL PROGRESO	5	6	10
TOTALES:	30	62	114

FUENTE: Región Oriental de UNEPAR

6. DESARROLLO DE LA INVESTIGACION.

De acuerdo con los términos del convenio firmado en Septiembre del 87, se tuvo conocimiento que el CEPIS organizaría en Lima, Perú, el "Primer Seminario Internacional sobre Desinfección por Oxidantes Mezclados". La participación en dicho seminario llevaba implícito el presentar algunas experiencias, por lo que la Dirección de UNEPAR, designó al suscrito para realizar la investigación de campo.

Se recibió a finales de Octubre el equipo y se comenzó a elaborar las estrategias de trabajo, las cuales se describirán a continuación:

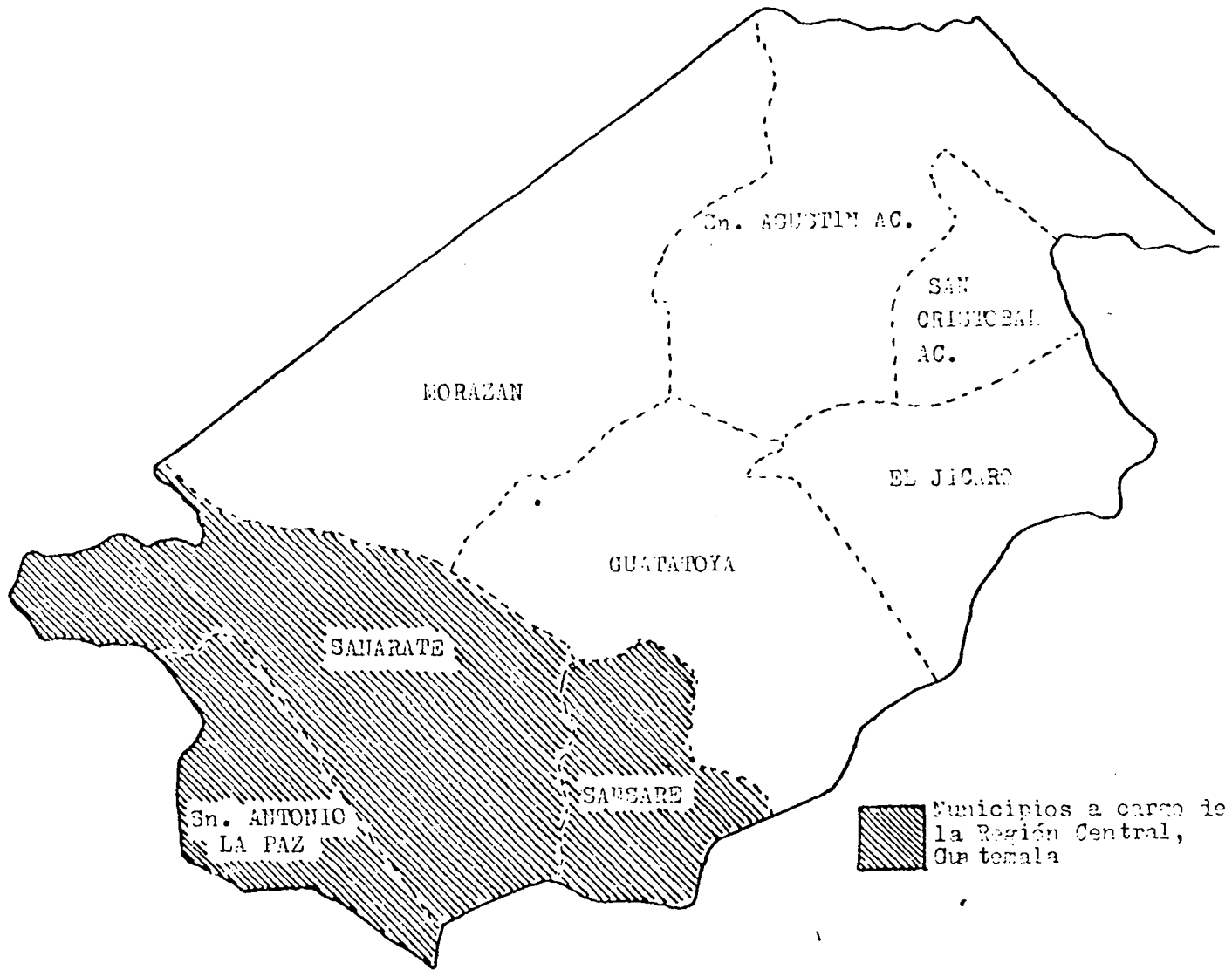


GRAFICA No. 3  
 COBERTURA REGION ORIENTAL



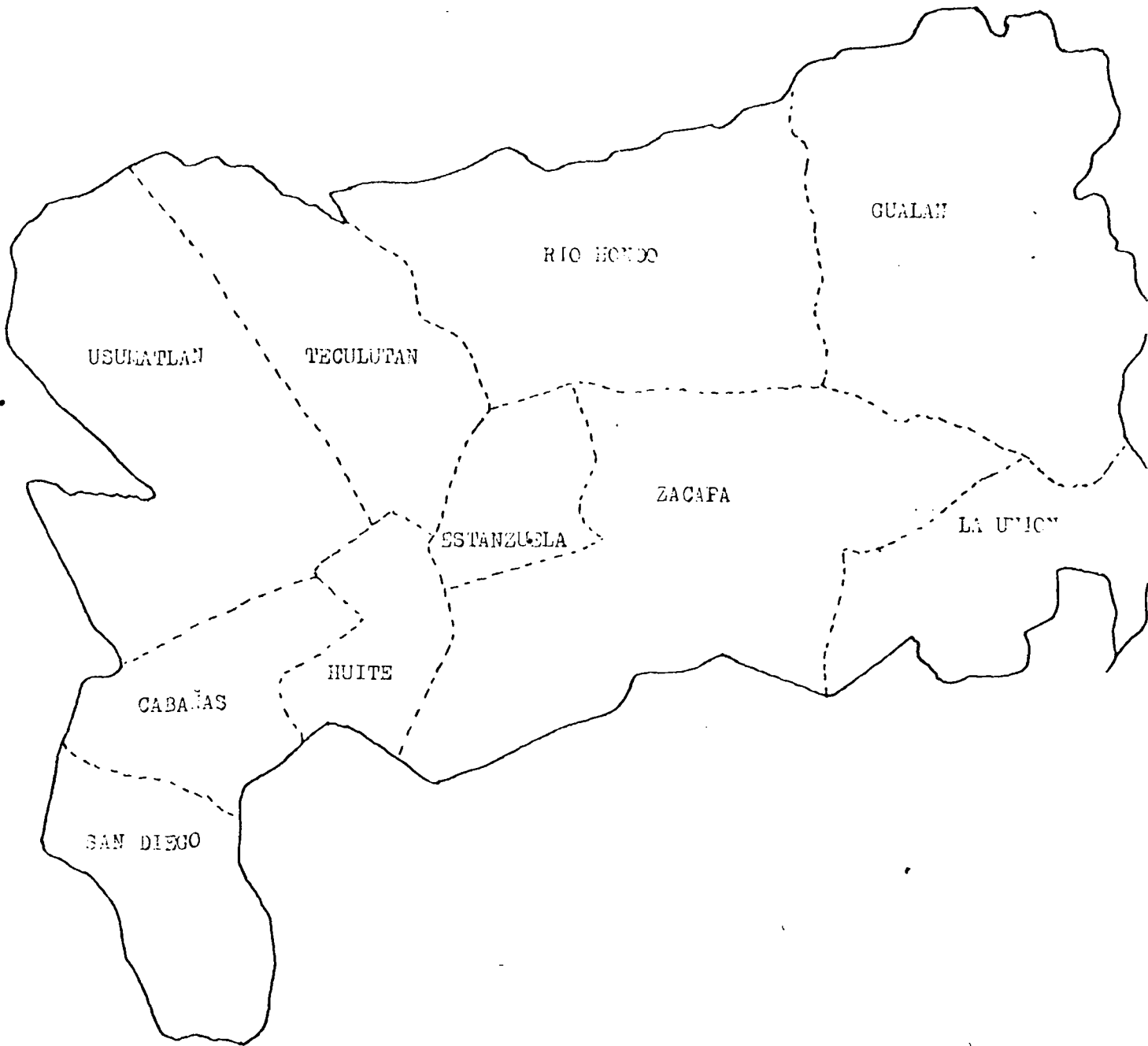
MUNICIPIOS	31
SISTEMAS	12-
COMUNIDADES	114-
POBLACION BENEFICIARIA	75,537

GRAFICA No. 4  
 DEPARTAMENTO DE EL PROGRESO



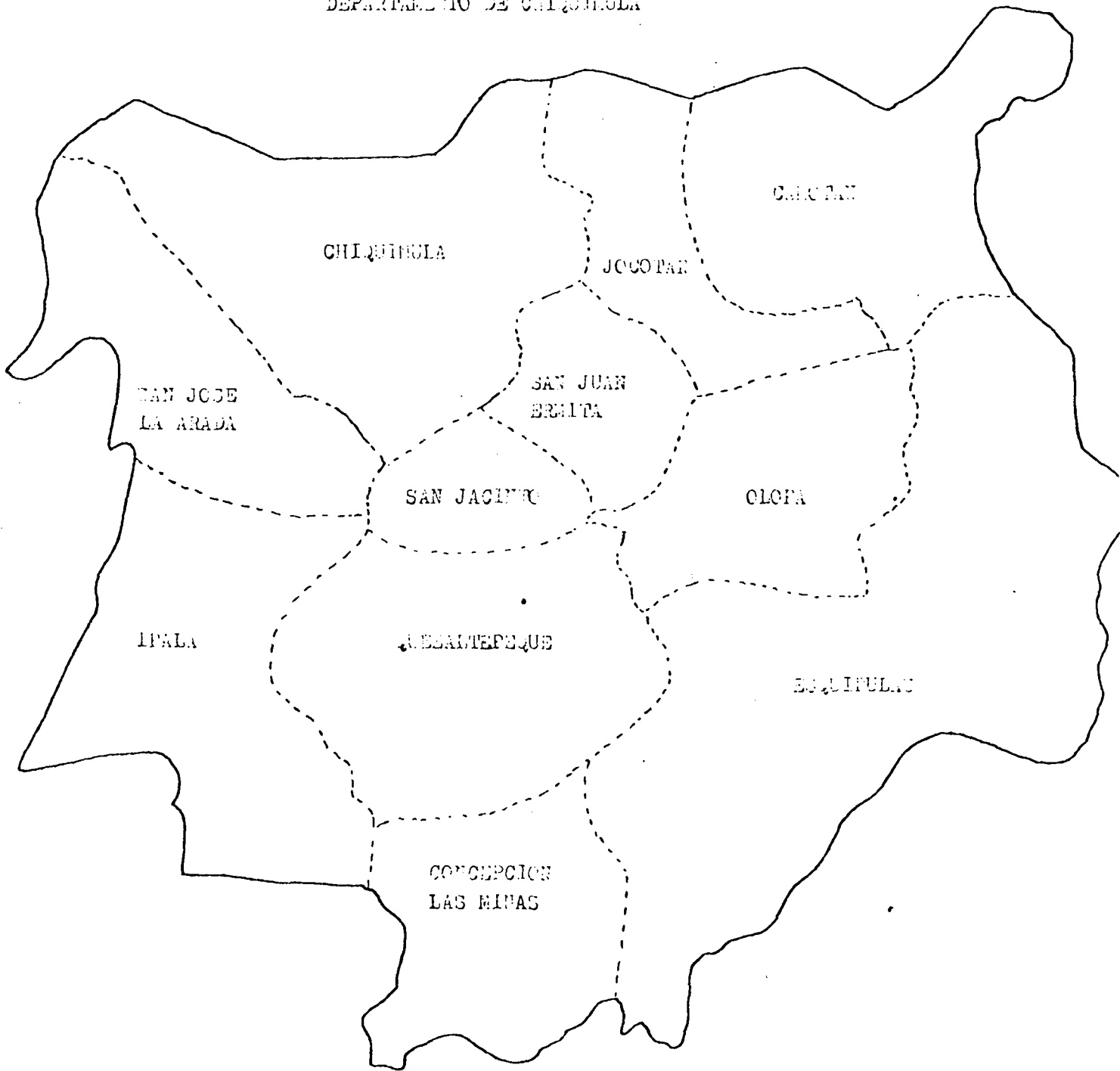
MUNICIPIOS	5
SISTEMAS	6
COMUNIDADES	10
POBLACION BENEFICIADA	9,933

GRAFICA No. 5  
 DEPARTAMENTO DE ZACAPA



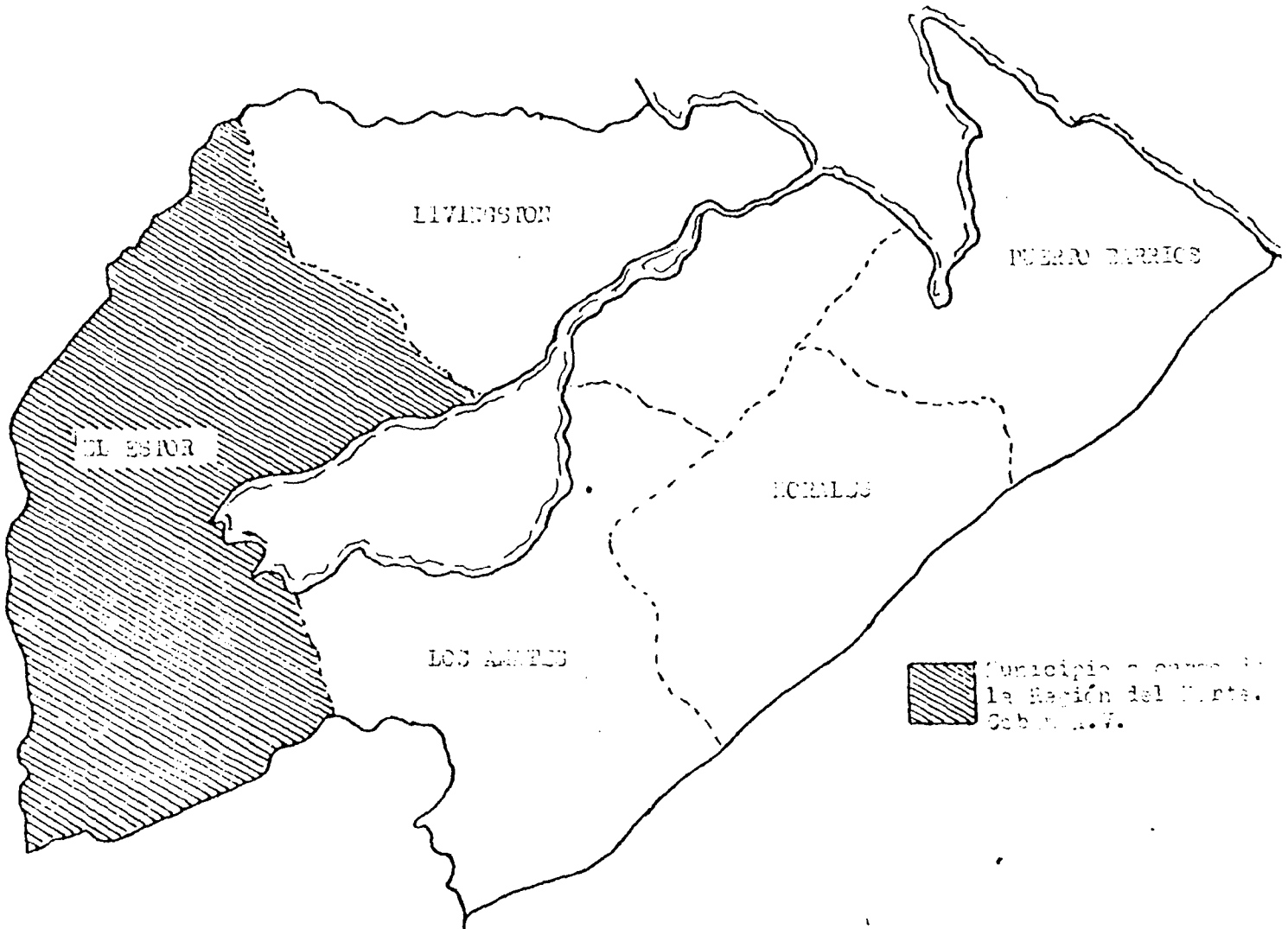
MUNICIPIOS	10
SISTEMAS	14
COMUNIDADES	33
POBLACION BENEFICIADA	18,627

GRAFICA No. 6  
 DEPARTAMENTO DE CHIQUINOLA



MUNICIPIOS	11
SISTEMAS	17
COMUNIDADES	31
POBLACION BENEFICIADA	18,165

GRAFICA No. 7  
 DEPARTAMENTO DE LISIALL



MUNICIPIOS	5
SISTEMAS	25
COMUNIDADES	40
POBLACION BENEFICIADA	29,312

## 6.1 EQUIPO

La unidad "OXI" producido por Oxidizers Inc, 4990 Euclid Road, Virginia Beach, VA 23462 entregado a UNEPAR, es una unidad que consta de una celda electro-lítica.

La gráfica No. 9 muestra una reproducción de la celda con sus componentes. En esta celda se produce una mezcla de oxidantes consistentes en cloro, oxígeno y peróxido de hidrógeno en el compartimiento del ánodo.

En el compartimiento del cátodo la celda produce hidrógeno en forma gaseosa e hidróxido de sodio en forma líquida.

El ánodo y el cátodo están separados por una membrana semipermeable.

La otra parte de la unidad es un autotransformador de corriente que utiliza 110 - 120 VAC a 60 Hz. La gráfica No. 10 muestra el autotransformador en vista anterior y posterior.

## 6.2 OPERACION DEL EQUIPO.

La unidad MOGGOD utiliza cristales de hidróxido de sodio en el compartimiento del ánodo, ambos en solución con agua destilada.

La sal debe ser de alta calidad, es decir cumplir con las normas Sterling TNA5 u otro equivalente con baja concentración de calcio.

La electrólisis de estas dos soluciones a un gasto energético de 3 a 10 voltios produce compuestos oxidantes mencionados anteriormente.

Los elementos oxígeno y cloro son absorbidos fuera del ánodo por un tubo de Polipropileno conectado a un venturi.

Para la investigación se utilizó un inyector MAZZEL, el cual se instaló cerca del punto de restricción creado por una válvula de compuerta, con lo cual se crea una presión diferencial la cual no debe ser menor del 24% para que se produzca el vacío que succione los oxidantes producidos.

La instalación la muestra la gráfica No. 11

El exceso de hidróxido de sodio líquido producido en el proceso es drenado tal y como muestra la gráfica No. 11.

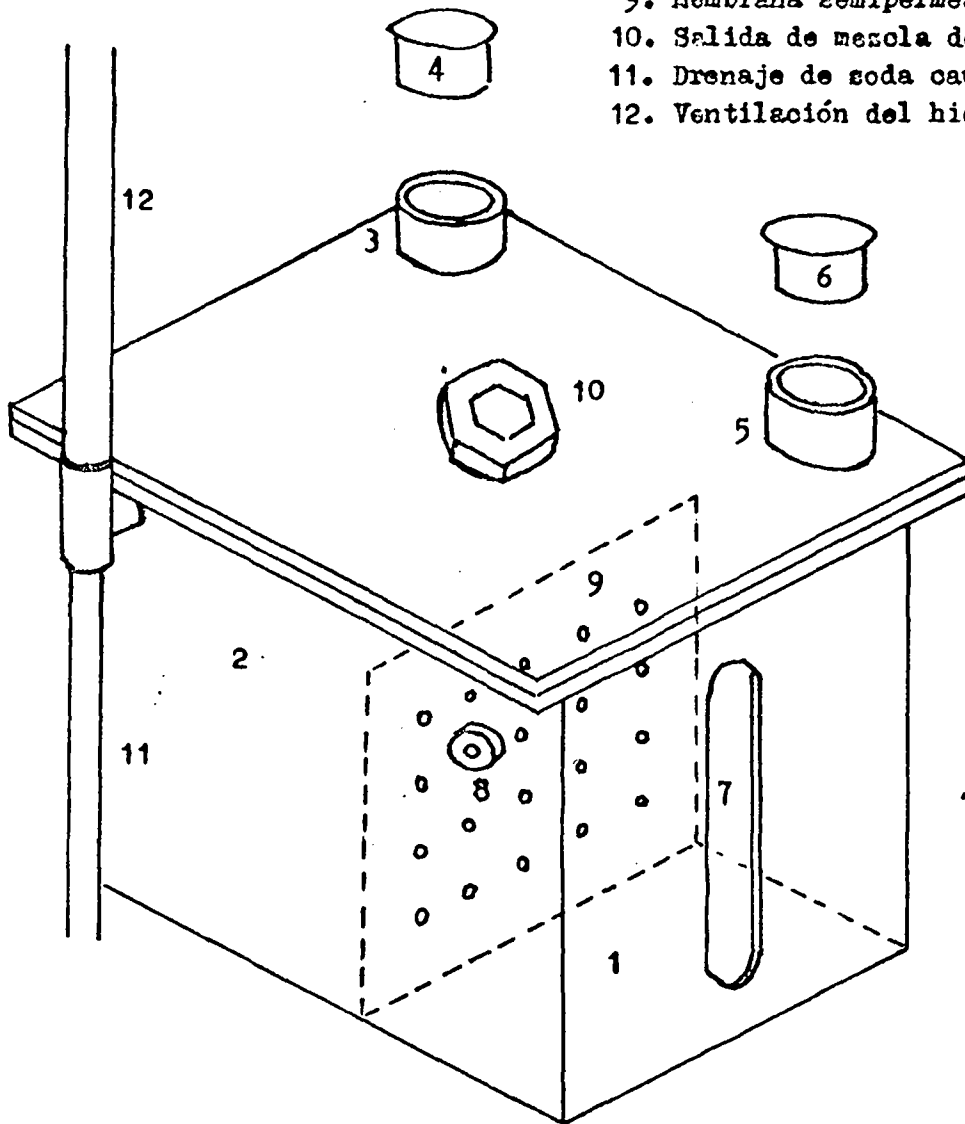
El gas hidrógeno proveniente del cátodo es más liviano que el aire y es eliminado a la atmósfera por un sistema de ventilación ubicado en el techo de la instalación.

La generación de gas es controlada por por la electrólisis de la solución. La velocidad de la electrólisis se controla variando la corriente eléctrica -

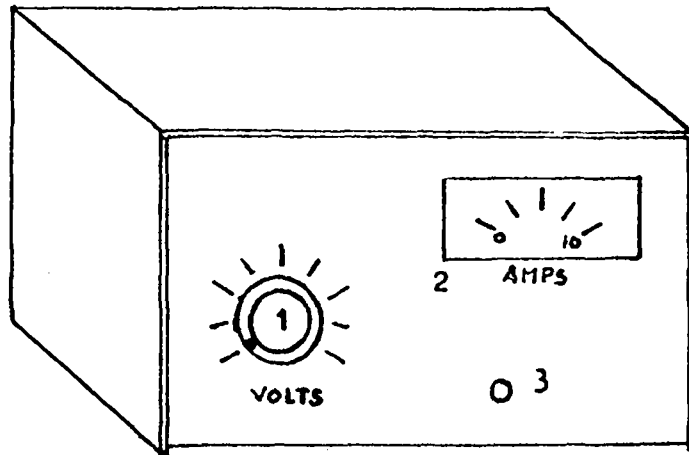
GRAFICA No. 9

CELDA ELECTROLITICA

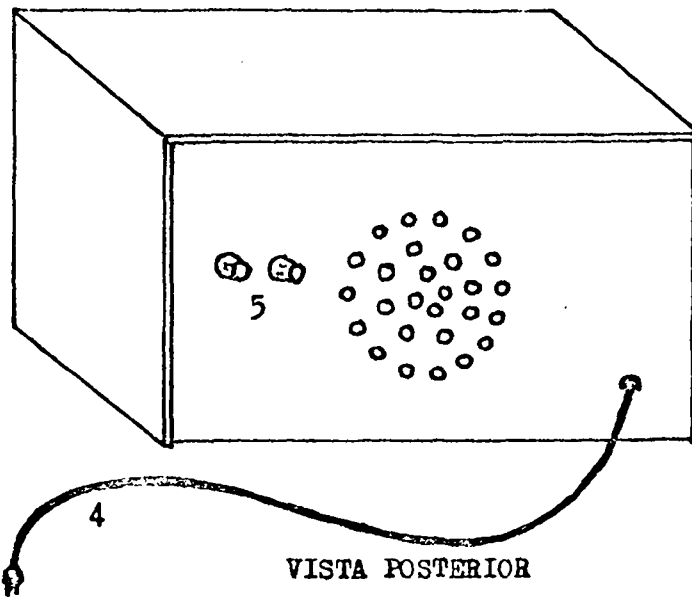
1. Compartimiento del ánodo
2. Compartimiento del cátodo
3. Orificio/agua soda caústica
4. Tapon plastico orificio 3
5. Orificio/agua sal
6. Tapon plastico orificio 5
7. Visor del nivel de sal
8. Drenaje de solución de sal
9. Membrana semipermeable
10. Salida de mezcla de gases
11. Drenaje de soda caústica
12. Ventilación del hidrógeno



AUTOTRANSFORMADOR



VISTA ANTERIOR



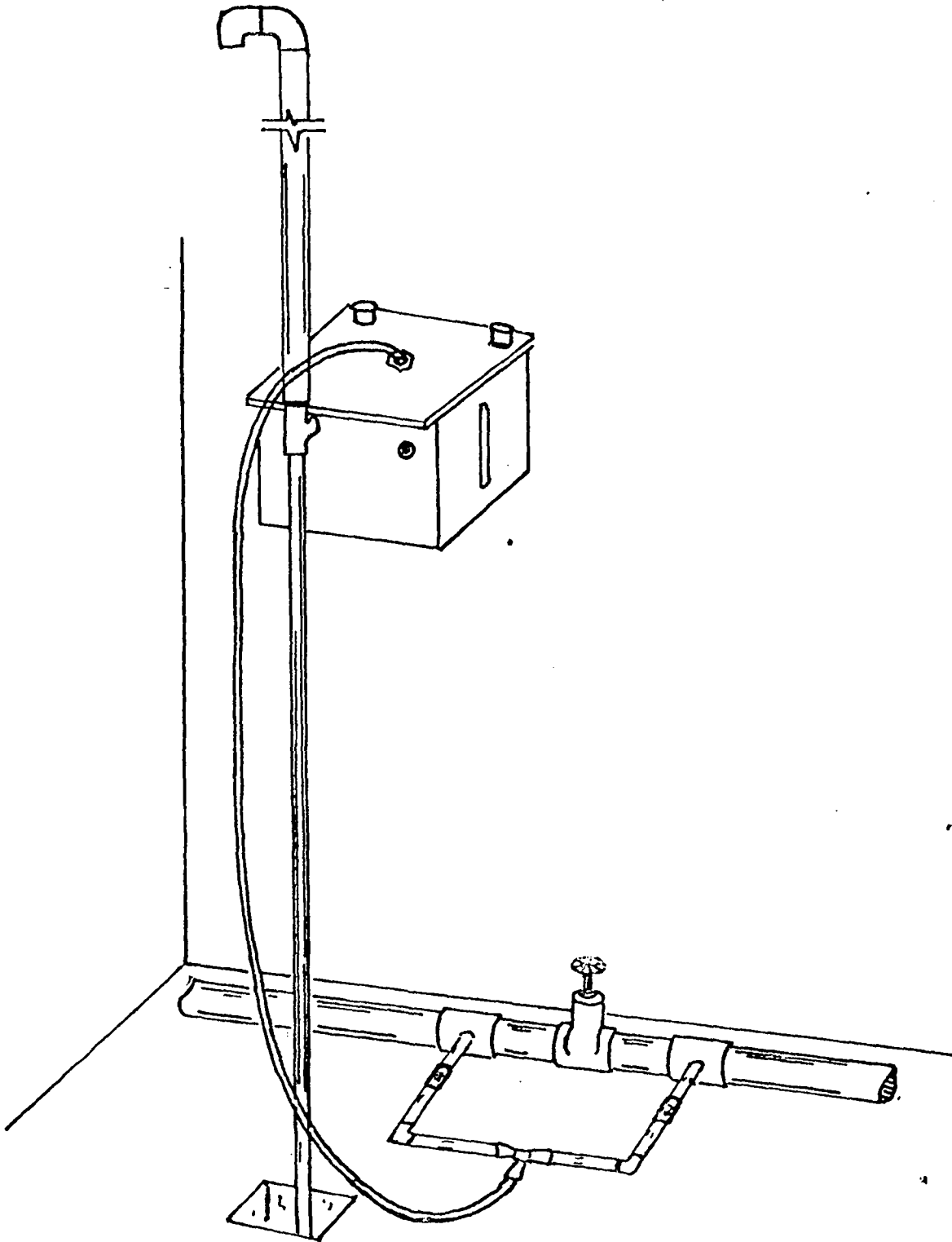
VISTA POSTERIOR

1. Botón de control voltaje
2. Medidor de corriente (amperios)
3. Fusible (3 amperios)
4. Cordón de Corriente
5. Conectores de salida corriente D.C.



GRAFICA No. 11

INSTALACION EQUIPO



que fluye por los electrodos y a su vez la corriente eléctrica se controla cambiando el voltaje usando un reóstato o botón de control como se muestra en la gráfica No. 10.

Con lo dicho anteriormente se concluye que el desinfectante residual que se desea, se obtiene ajustando unicamente el botón de control del autotransformador. Este residual se lee con un comparador en el sistema de distribución

### 6.3 SELECCION DE LA COMUNIDAD.

Dentro de la responsabilidad de UNEPAR, quedó la selección de la comunidad para desarrollar la investigación.

El criterio de selección quedaba determinado por los siguientes parámetros.

- Ubicación:

Lo suficientemente cerca de un laboratorio con capacidad para hacer análisis bacteriológicos y próxima a la Oficina Regional para facilitar el seguimiento.

- Tamaño de la población:

Entre 500 y 1200 habitantes.

- Servicios existentes:

Energía eléctrica y un sistema de agua con redes de distribución para un servicio continuo.

- Calidad bacteriológica y físico-química del agua:

Agua con necesidad de desinfección y bajo nivel de turbiedad.

- Organización de la comunidad:

La comunidad debe contar con una junta administradora o Comité de Agua Potable y proporcionar un operador de la unidad de desinfección.

En base en los aspectos anteriores y revisando el inventario de comunidades abastecidas con sistemas de agua potable se seleccionó la aldea PUEBLO NUEVO, en el municipio de Usumatlán, del departamento de Zacapa.

Las características que la población reunía se describen a continuación:

- UBICACION:

La comunidad se encuentra a la altura del kilómetro 114 de la carretera CA-9 Norte y a 56 kilómetros de la ciudad de Chiquimula, sede de la Región Oriental de UNEPAR.

En la ciudad se contó con la colaboración del laboratorio de la Jefatura de Area de Salud y del laboratorio del Centro Univesitario del Nor-Oriente, CUNORI. La población se encuentra en la cuenca del Río Motagua, el río más grande de Guatemala y en sus orillas corre el Río La Palmilla que aguas arriba permite la obra de captación que surte el sistema de agua. Dista de la cabecera Municipal, Usumatlán, 8 kilómetros y de la ca becera departamental, Zacapa, 40 kilómetros. La situación puede observarse en la gráfica No. 12.

- TAMAÑO DE LA POBLACION:

Estudios hechos para el mejoramiento del actual acueducto, indican que cuenta con 90 viviendas con una estimación de 540 habitantes en la zona de mayor concentración.

- SERVICIOS EXISTENTES:

Carretera de terracería con una longitud de 2 kilómetros que interconecta con la carretera CA-9 Norte.

Escuela y edificios religiosos (dos).

Energía Eléctrica a nivel domiciliario. Se carece de alumbrado público.

Servicios de Salud, prestados por el puesto de Salud de la Cabecera Municipal.

Sistema de Agua potable, construido en 1976, con captación de fuente superficial sin tratamiento. El servicio cuenta actualmente con 60 conexiones domiciliarias, un tanque de almacenamiento de 30 M<sup>3</sup>; con un caudal de entrada de 1.4 L/S equivalente a 120,960 litros diarios y una longitud total de 4506.00 metros de tubería instalada.

- CALIDAD BACTERIOLOGICA:

Siendo una fuente superficial era de esperarse que existiera algún rango de contaminación, sobre todo porque en los alrededores de la obra de captación hay 6 viviendas que utilizan el agua del río La Palmilla para resolver todas sus necesidades.

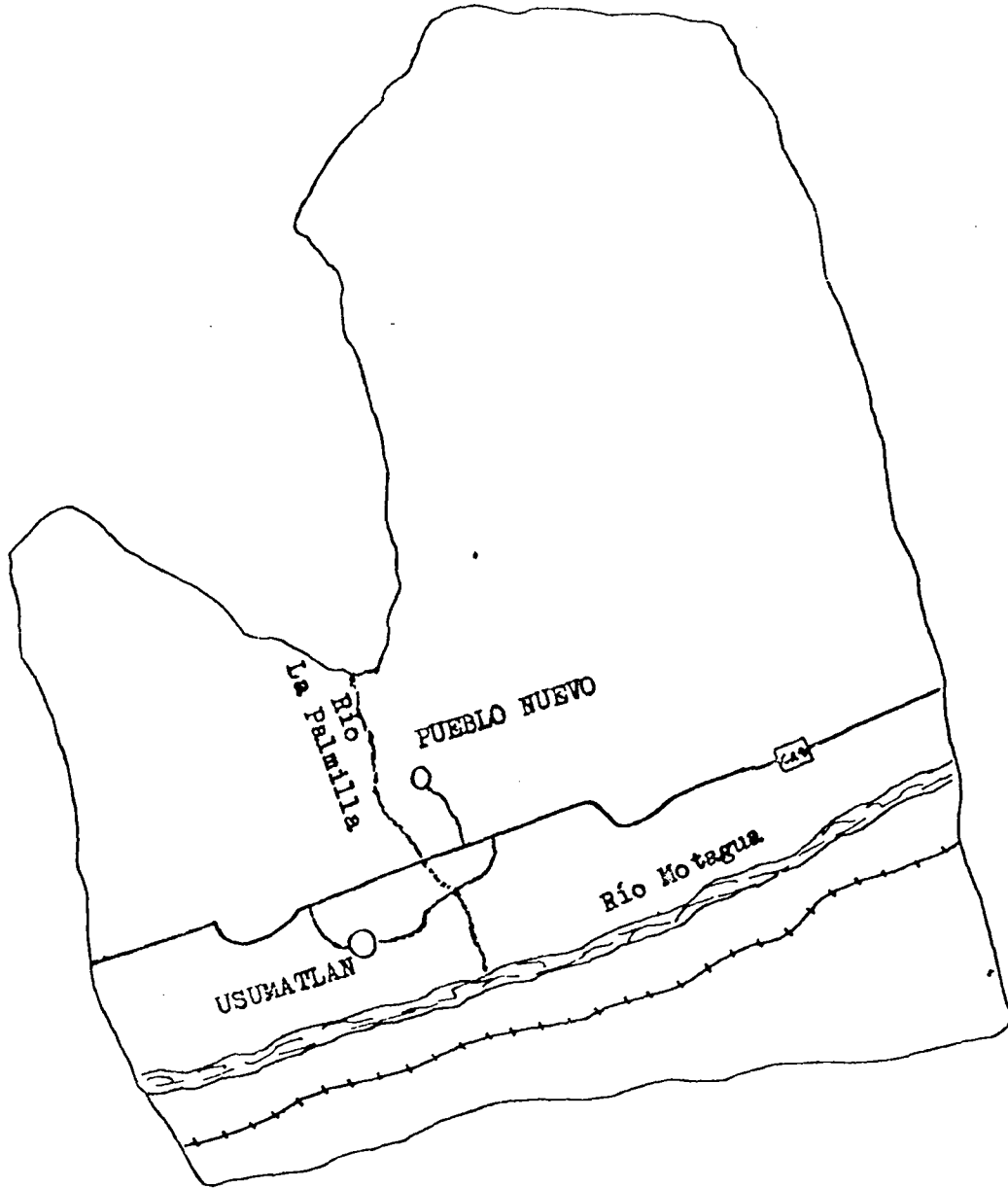
Efectuado el análisis se comprobó la hipótesis y la gráfica No. 13, muestra el resultado del análisis previo a la investigación.

No fue posible analizar y comparar la turbiedad y color con los patrones usuales, pero a simple vista el agua presenta un aspecto libre de turbiedad e incolora.

- ORGANIZACION COMUNAL:

La comunidad cuenta con un Comité Pro-Mejoramiento, cuyos miembros sobre todo el Presidente y Vice-Presidente, prestaron una colaboración y un entusiasmo encomiable al desarrollo de la experiencia. El Vicepresidente fue el operador auxiliar en el control y mantenimiento del equipo.

GRAFICA No. 12  
MUNICIPIO DE USUMATLAN



PUEBLO NUEVO

CONSTRUCCION SISTEMA	1,976
CONEXIONES DOMICILIARES	60
TUBERIA INSTALADA	4,506 Mts
CAUDAL DISPONIBLE	1.4 L/S

GRAFICA No. 13

RESUMEN DE RESULTADOS  
ANALISIS BACTERIOLOGICOS

FECHAS CONDICIONES	27-10-87	12-11-87	19-11-87	25-11-87
No. MEMBRANAS FILTRANTES	2	2	2	2
MEDIO SELECTIVO	ENDO	ENDO	ENDO	ENDO
VOLUMEN MUESTRA	25	25	25	25
No. COLONIAS COLIFORMES	216	68	0	
COLIFORMES p/100 ML	5,400	1,700	0	
TIEMPO INC.	24 Hrs.	24 Hrs.	24 Hrs.	24 Hrs.

#### 6.4 INSTALACION DEL EQUIPO:

Para realizar el montaje, se escogió un punto de la línea de conducción situado a 15.00 m. del tanque de almacenamiento. Se diseñó la caseta de protección del equipo, siguiendo las instrucciones del fabricante en cuanto a la ventilación inferior y superior para evacuación de los gases tanto los livianos y pesados en relación al aire.

Las dimensiones de la caseta fueron:

- Largo: 1.20 m.
- Ancho: 1.20 m.
- Alto: 2.00 m.

Fue construida con blocks de concreto de 0.20x0.20 x0.40 m. y una cubierta de lámina galvanizada.

Se proveyó de una caja de registro, utilizada como re-sumidero del rebalse del hidróxido de sodio líquido.

Las dos unidades del equipo fueron colocadas en plan-- chas de concreto a 1.40 m. del nivel del suelo.

La colocación del venturi ya se ilustró anteriormente en la gráfica No. 11.

#### 6.5 GASTOS DE INSTALACION Y MONTAJE:

La instalación y montaje del equipo, exigió diver- sas actividades e inversiones las cuales se enumeran a continuación:

##### 6.5.1 MATERIALES CONSTRUCCION CASETA:

- Arena de río	M <sup>3</sup>	0.5	Q. 9.00
- Block cemento 0.20x0.20 x0.40	U	100	" 45.00
- Bolsas de cemento	qq	6	" 44.30
- Bolsas de cal	qq	1	" 4.50
- Varillas de hierro 3/8	U	6	" 23.54
- Alambre amarre calibre 18	Lb.	5	" 4.00
- Clavo de 3"	Lb.	5	" 4.00
- Clavo de lámina	Lb.	1	" 0.80
- Lámina 6'	U	3	" 10.80
- Bisagras 3"	U	2	" 2.00
- Puerta	U	1	" 50.00
- Candado	U	1	" 15.00
		TOTAL:	<u>Q212.94</u>

6.5.2 MATERIALES Y ACCESORIOS INSTALACION EQUIPO:

- Llaves de paso de 1/2"	U	2	Q.	6.50
- Válvula de compuerta de 2"	U	1	"	104.00
- Adaptadores Macho PVC de 2"	U	2	"	5.44
- Adaptadores Macho PVC de 1 1/2"	U	4	"	5.78
- Tees Reductoras PVC de 2" x 1/2"	U	2	"	9.65
- Codos PVC de 1/2" x 90°	U	2	"	1.14
- Tubo PVC de 2" 160 PSI	TUBO	1	"	30.12
- Tubo PVC de 1/2"	TUBO	1	"	7.00
- Solvente para PVC rígido	----	1/8	"	8.45
- Alambre calibre 10	m.	140	"	91.00
- Cinta de aislar	U	1	"	2.50
- Cinta teflón	U	1	"	2.50
- Toma corriente	U	1	"	2.95
- Aisladores de 1 1/2"	U	14	"	10.50
- Flip-un 15 Amp.	U	1	"	14.50
			TOTAL:	Q. 302.03

6.5.3 HERRAMIENTA Y EQUIPO:

- Prensa de banco de 2" x 1/2"	1
- Llaves Stilson No. 24	2
- Cubetas para concreto	4
- Nivel	1
- Plomada	2
- Cuchara de albañil	3
- Piochas	3
- Palas punta redonda	3
- Escuadrilongo	1

NOTA: Este equipo fue proporcionado por la Región Oriental de UNEPAR, sin costo.

6.5.4 EQUIPO ESPECIFICO Y REACTIVO:

- Comparímetro	U	1	Q.	20.00
- Yoduro de potasio	gr.	40	"	10.00
- Almidón	gr.	-	"	0.20
- Formol	ml.	-	"	1.60
- Soda caustica	Lb.	3	"	6.42
- Hipoclorito de calcio 65%	Lb.	2	"	18.00
- Agua destilada	Lts.	14	"	26.21
- Cristalería	-	-	"	5.00
			TOTAL:	Q. 87.43

#### 6.5.5 MANO DE OBRA:

- Instalación 5 operarios /5 días		Q. 200.00
- Seguimiento control muestras 1 persona /3 días		" 30.00
- Operación Equipo 1 persona /15 días		" 169.95
	TOTAL:	Q. 399.95

#### 6.5.6 TRANSPORTE:

- Viajes de 140 Kms.	7	Q. 203.00
- Viajes de 140 Kms.	2	" 17.40
	TOTAL:	Q. 220.40

### 6.6 OPERACION Y SEGUIMIENTO:

La puesta en acción del equipo de desinfección, se realizó siguiendo las instrucciones proporcionadas por el fabricante. Hubo dudas e incertidumbres, las cuales fueron subsanadas durante la operación, la cual confirmó o indicó las modificaciones pertinentes.

La operación y seguimiento se realizó en diferentes etapas y con mecanismos de control adecuados al parámetro que se deseaba medir, los cuales se tratarán de describir en las siguientes líneas.

#### 6.6.1 ANALISIS BACTERIOLOGICOS:

Para determinar la bondad y/o en su caso ineficacia del equipo se practicaron análisis bacteriológicos antes y durante la investigación. En la gráfica No. 13 se muestra la tendencia de los análisis practicados, los cuales se practicaron con el método de las Membranas Filtrantes.

#### 6.6.2 DETERMINACION DE DEMANDA DE CLORO:

Se utilizó un método de campo con lo cual se obtiene una determinación aproximada. El procedimiento consistió en preparar una solución que contuviera 1 gr/lit de cloro. Esta solución se preparó en laboratorio con hipoclorito de calcio al 65% y se agregó al agua que se iba a someter al tratamiento, para determinar por comparación la cantidad de cloro necesaria para el tratamiento.



GRAFICA No. 14

RESUMEN GENERAL GASTOS DIRECTOS

RENGLON	MONTO
MATERIALES CASETA	212.94
MATERIALES INSTALACION	302.03
EQUIPO Y REACTIVOS	87.43
HANO OBRA	399.95
TRANSPORTE	220.40
SUBTOTAL	1222.75
IMPREVISTOS 10%	122.28
TOTAL	1345.03

### 6.6.3 OPERACION DEL EQUIPO:

Se inició de acuerdo con las especificaciones del fabricante y paralelamente se iniciaron los controles de los diferentes parámetros involucrados en la experiencia, los cuales se muestran en los siguientes gráficos:

- Lectura de gravedad específica del Na OH, gráfico No. 15. Las lecturas fueron hechas tres veces al día.
- Lectura de gravedad específica del Na U, gráfico No. 16. Las lecturas fueron hechas tres veces al día.
- Control de cloro residual, gráfico No. 17. Se practicó una lectura por día en diferentes puntos de la red de distribución.
- Control del Ph, gráfico No. 17. Se practicó una lectura por día, juntamente con lectura del cloro residual.
- Demanda de Na OH en gr, gráfico No. 18. Indica el consumo del hidróxido por día.
- Demanda de Na C/ en Lb., gráfico No. 18. Indica el consumo de sal por día.
- Demanda de Energía Eléctrica, gráfico No. 19. Este dato globaliza el consumo total diario de energía eléctrica en kilowatios. El consumo diario incluye la utilización de la energía para el alumbrado de la vivienda y aparatos eléctricos (radio-grabadora).

### 6.7 RESULTADOS:

Es prematuro emitir opinión sobre resultados finales, los cuales se consideren concluyentes, sobre todo por el poco tiempo que hubo disponible para la investigación.

Los resultados obtenidos por otra parte serán vistos un tanto subjetivamente por el autor de este informe, dado que fue el conductor de la experiencia. Sin embargo se tratará en lo posible lograr el mayor grado de objetividad.

Teniendo en cuenta lo positivo que será el llegar a conclusiones imparciales que beneficien al área rural de nuestros países.

GRAFICA No. 15

CONTROL DE LA SOLUCION DE HIDROXIDO DE SODIO															
DIAS HORAS	1	2	3	4	5	6	7	8	9	10	11	12	13	14	15
8:00		1,200	1,250	1,275	1,175	1,150	1,275	1,250	1,300	1,250	1,250	1,250	1,200	1,175	
12:00		1,225	1,250	1,225	1,175	1,125	1,225	1,225	1,300	1,250	1,250	1,250	1,200	1,175	
17:00		1,200	1,175	1,250	1,150	1,175	1,250	1,250	1,300	1,250	1,225	1,250	1,200	1,175	

GRAFICA No. 16

CONTROL DE LA SOLUCION DE CLORURO DE SODIO															
<del>DIAS</del> HORAS	1	2	3	4	5	6	7	8	9	10	11	12	13	14	15
8:00		1,150	1,150	1,200	1,200	1,200	1,200	1,200	1,200	1,200	1,200	1,200	1,200	1,200	
12:00		1,150	1,200	1,200	1,200	1,150	1,200	1,200	1,200	1,200	1,200	1,200	1,200	1,200	
17:00		1,150	1,150	1,200	1,200	1,175	1,200	1,200	1,200	1,200	1,200	1,200	1,200	1,200	

GRAFICA No. 17  
CONTROL CLORO RESIDUAL Y Ph

DIA	AMPERAJE UNIDAD	LECTURA COMPARIMETRO	
		CLORO RESIDUAL	Ph
1	7	< 0.4	
2	6	0.3	7.8
3	5	0.3	8.2
4	6	0.4	7.6
5	6	0.4	8.2
6	6	0.4	7.8
7	6	0.3	8.2
8	6	0.4	8.2
9	6	< 0.4	7.6
10	6	< 0.4	8.2
11	6	0.4	8.2
12	-	-	-
13	-	-	-
14	6	0.4	7.8
15	6	< 0.4	7.8

GRAFICA No. 18  
 "CONSUMO REACTIVOS"

DIA	SODA	SAL
1	42.9 grs.	8 Oz.
2	85.8 Grs.	8 Oz.
3	42.9 grs.	8 Oz.
4	42.9 grs.	8 Oz.
5	75.0 grs.:	6 Oz.
6	64.3 grs.	6 Oz.
7	64.3 grs.	6 Oz.
8	42.9 grs.	8 Oz.
9	42.9 grs.	8 Oz.
10	- - -	8 Oz.
11	- - -	8 Oz.
12	- - -	- - -
13	- - -	- - -
14	- - -	12 Oz.
15	- - -	8 Oz.

GRAFICA No. 19  
CONSUMO ENERGIA ELECTRICA

DIA	LECTURA INICIAL	LECTURA FINAL	CONSUMO
1	404	406	2 Kv.
2	406	408	2 Kv.
3	408	409	1 Kv.
4	409	411	2 Kv.
5	411	413	2 Kv.
6	413	415	2 Kv.
7	415	417	2 Kv.
8	417	419	2 Kv.
9	419	422	3 Kv.
10	422	424	2 Kv.
11	424	426	2 Kv.
12	-	-	-
13	-	-	-
14	426	431	5 Kv.
15	431	434	3 Kv.

### 6.7.1 ASPECTOS CUALITATIVOS:

- Partiendo de cero, la experiencia fue sumamente valiosa ya que fue posible poner en operación un equipo desconocido, teniendo situaciones adversas derivadas de lo inflexible de un aparato gubernamental administrativo.
- Una tecnología nueva en el país, fue puesta a prueba, en las condiciones reales del área rural. Nada se inventó y la experiencia fue realizada y controlada con los recursos escasos con que cuentan las instituciones gubernamentales.
- La experiencia fue rutinaria y rigurosamente controlada con los elementos que fue posible disponer.
- El equipo es funcional y, a juicio del que suscribe este informe, produce buenos resultados con una operación sumamente sencilla en contraposición con otros sistemas de desinfección recomendados para el área rural.

### 6.7.2 ASPECTOS CUANTITATIVOS:

Solamente se analizarán algunos de los aspectos más significativos, ya que se insiste en que es necesario desarrollar la experiencia con:

- Mayor tiempo de investigación.
- Equipo adecuado para análisis bacteriológicos y exámenes físico-químicos.
- Recurso humano altamente calificado, en controles de calidad del agua.

Entre los aspectos a señalar caben principalmente los siguientes:

El MOGGOD, produjo la cantidad de gases oxidantes, necesaria en este caso, para disminuir y terminar con los indicadores bacteriológicos que se encontraron en el agua antes de la realización de la experiencia.

Debe hacerse notar que, como lo muestra el gráfico No. 13, después de la primera toma de muestra, ya efectuándose el tratamiento el análisis bacteriológico aún indicaba presencia de coliformes.



Queda la incógnita de saber si se debió a haber sacado la muestra dos días después de haberse iniciado el proceso de desinfección, se decidió desinfectar el tanque de almacenamiento y luego se tomó nuevamente la muestra, la cual indicó ausencia de coliformes.

En este caso... ¿ influiría el hecho de haberse desinfectado el tanque o sería que para hacer el análisis se utilizó reactivos y materiales nuevos ?

La gráfica No. 13 indica el resultado de los diferentes análisis bacteriológicos practicados.

La gráfica No. 13, debe interpretarse con la siguiente información:

- 27-10-87: Agua sin ninguna clase de tratamiento, antes de iniciarse la experiencia
- 12-11-87: Agua analizada después de dos días de iniciado el tratamiento.
- 19-11-87: Agua analizada después de nueve días de tratamiento y luego de haberse desinfectado el tanque de almacenamiento.
- 25-11-87: Agua analizada después de quince días de tratamiento.

#### 8 OBSERVACIONES FINALES

El suscrito quiere dejar constancia de su reconocimiento a las autoridades de la CPS y de UNEPAR que estuvieron atentos a prestar el apoyo necesario para el desarrollo de la experiencia.

Reconocimiento especial a las autoridades de la Jefatura de Area de Salud de Chiquimula y a la Dirección del Centro Universitario del Nor-Oriente en cuyos laboratorios y con su personal calificado se realizó el control de la calidad del agua.

Finalmente al personal de la Región Oriental que dedicó lo mejor de su esfuerzo para apoyar el desarrollo del proyecto en sus diversas fases y sobre todo en la preparación del presente informe y el documental audiovisual correspondiente.

Ing. José Gilberto González  
Jefe Región Oriental  
UNEPAR

DIVISION DE SERVICIO DEL MEDIO  
 AMBIENTE DEL INSTITUTO TECNOLÓGICO  
 POR EL METODO DE MEMBRANAS DE FILTRACION

No. 89/87.

ANÁLISIS BACTERIOLÓGICO:

Muestra de: PUEBLO NUEVO UZUMTELAN (Z. OAXCA).  
 Fecha en que fue captada la muestra: 27-10-87.  
 Hora en que fue captada la muestra: 15:30 Hrs P.M.  
 Sitio: Servicio Domiciliario.  
 Fuente: Servicio Domiciliario.  
 Persona que captó la muestra: CSC R. CHACTUN RAMOS (MUEBRO)  
 Fecha en que dió principio el examen: 27-10-87.

CARACTERES GENERALES:

Color: Incoloro Aspecto: Claro  
 Sustancia en suspensión: \_\_\_\_\_  
 Investigación del Grupo Coliforme  
 Incubación a 35°C

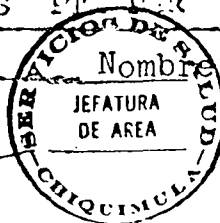
No. Membrana Filtrantes	Medio Selectivo	Volumen Muestra	Colonia Coliforme	Coliformes p/100 ml	Tiempo Inob.
2	ENDO	25	216	5,400	24 Hrs

Observaciones: Por Presentar Número de Colonias del Grupo Coliforme Tot.

Conclusiones: " EL AGUA NO ES apta para el consumo humano.

Fecha: 27-10-87. Nombre: Maria Adela Valdez C.  
 MARIA ADELA VALEZ C.

x *[Handwritten signature]*



DIVISION DE SANEAMIENTO DEL MEDIO  
 AMBIENTE DEL INSTITUTO TECNOLÓGICO DE GUATEMALA  
 POR EL METODO DE MEMBRANAS DE FILTRACION

No. 85/87.

RESUMEN BACTERIOLOGICO:

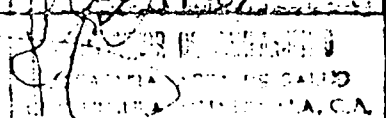
Muestra de: PUEBLO NUEVO UZUMATAIN ZACAPA.  
 Fecha en que fue captada la muestra: 19-11-87.  
 Hora en que fue captada la muestra: 13:55 Hrs PM.  
 Sitio: Pueblo Nuevo .  
 Fuente: Conección Domiciliaria (EUSEBIO JACINTO)  
 Persona que capto la muestra: OSCAR CHACTUN RAMOS. UNEPAR.  
 Fecha en que dió principio el examen: 19-11-87.

CARACTERES GENERALES:

Color: Incoloro Aspecto: Claro  
 Sustancia en suspensión: \_\_\_\_\_  
 Investigación del Grupo Coliforme  
 Incubación a 35°C

No. Membrana Filtrantes	Medio Selectivo	Volumen Muestra	Colonia Coliforme	Coliformes p/100 ml	Tiempo Inob.
2	EDO	25	0	0	24 Hrs.

Observaciones: Por No Presentar Ningún Número de colonias del Grupo  
 Conclusiones: Coliformes Total "EL AGUA SI ES APTA PARA EL CONSUMO HUMANO.  
 Fecha: 20-11-87 Nombre: Maria Adela Valdes C.  
 MARI A ADELA VALDES C.



DIVISION DE SALUBRIDAD DEL MEDIO  
 AMBIENTE DEL INSTITUTO GUATEMALTECO  
 POR EL METODO DE MEMBRANAS DE FILTRACION

No. 82/87.

MEMORIA DE INVESTIGACION:

Muestra de: PUEBLO NUEVO (UZUMATLAN) ZACAPA.  
 Fecha en que fue captada la muestra: 12-11-87.  
 Hora en que fue captada la muestra: 10:04 Hrs.  
 Sitio: Pueblo Nuevo  
 Fuente: Servicio Domiciliario (EUSEVIO JACINTO).  
 Persona que captó la muestra: OSCAR CHAGUN RAMOS UNEPAR.  
 Fecha en que dió principio el examen: 12-11-87.

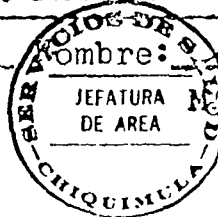
CARACTERES GENERALES:

Color: Incoloro Aspecto: Calro  
 Sustancia en suspensión: Pequeñas Partículas.  
 Investigación del Grupo Coliforme  
 Incubación a 35°C

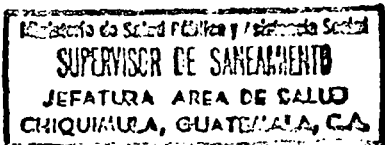
No. Membrana Filtrantes	Medio Selectivo	Volumen Muestra	Colonia Coliforme	Coliformes p/100 ml	Tiempo Inob.
2	ENDO	25	68	1,700	24 Hrs.

Observaciones: Por Presentar "Número de Colonias del Grupo Coliforme Total"  
 Conclusiones: EL AGUA NO ES APTA PARA EL CONSUMO HUMANO.

Fecha: 13-11-87.



Nombre: Maria Adela Valdes C.  
 MARIA ADELA VALDES C.



ENSAYO SOBRE DEGRADACION DE  
DETERGENTES ANIONICOS  
POR EMPLEO DE LA OZONOCOLORACION

Dr Omar J. Simoni

BUENOS AIRES, ARGENTINA, Noviembre 1987

ENSAYO SOBRE DEGRADACION DE  
DETERGENTES ANIONICOS  
POR EMPLEO DE LA OZONOCORACION

Dr. OMAR J. SIMONI

Director del Estudio Consultor en Contaminación Ambiental - ECCA - Maturin 2887,  
Buenos Aires, Argentina

Asesor Técnico de la Federación Argentina de Aguas Gaseosas y Bebidas sin Alcohol

Director Técnico de CIMES - Control Integral Metodológico de Sodas

INTRODUCCION

Se verificó la propiedad del ozonoclorador marca GIDOX en la eliminación de detergentes aniónicos, evaluados cuantitativamente como sustancias reactivas al azul de ortotoluidina.

TECNICA DE EVALUACION

Se prepararon soluciones de detergentes tipo en concentraciones crecientes, de acuerdo a las normas IRAM - Instituto Racionalizador Argentino de Materiales -.

Se procedió al llenado con agua ozonoclorada con una concentración de 10.2 mg/l de oxidante.

Se realizaron luego los ensayos químicos para verificar los valores residuales en las soluciones tipo al cabo de 24 y 48 horas. Tabla 1.

CONCLUSIONES

Se constató la alta eficacia destructiva de la ozonocloración sobre las cadenas hidrocarbonadas de un tensioactivo aniónico lineal.

Los estudios futuros deberán encaminarse a evaluar tiempos de acción concentraciones menores, dispositivos de aplicación continua, etc.

TABLA I - Concentraciones de detergentes aniónicos  
en aguas crudas y tratadas con GIDOX

	<u>Conc. en detergentes (mg/l)</u>		
	<u>Muestra N°</u>		
	<u>1</u>	<u>2</u>	<u>3</u>
Inicial (cruda)	600	300	30
A las 24 horas	8	4	1
A las 48 horas	8	3.2	1

# Ozonocloración con producción in-situ

---

## UNA NUEVA TECNICA DE INTERESANTES POSIBILIDADES

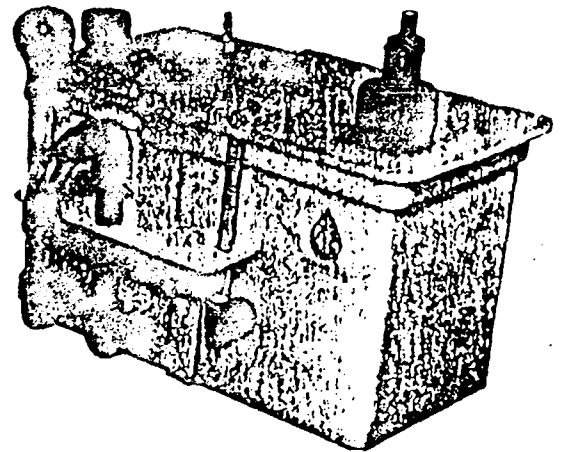
---

La provisión de agua potable y más específicamente la entrega al usuario de agua segura desde el punto de vista microbiológico es un problema que, lejos de estar solucionado, preocupa tanto a los organismos de provisión de agua como a las autoridades de la salud pública.

Según la Organización Mundial de la Salud, 4 de cada 5 camas en todos los hospitales del mundo están ocupadas por enfermos relacionados directa o indirectamente con la mala calidad del agua de bebida y/o inadecuada disposición de excretas, tornándose este problema mucho más aflictivo en las áreas rurales y en la periferia de las grandes ciudades del Tercer Mundo.

La causa, estudiada y reconocida, yace en la falta de equipos y métodos de desinfección que sean sencillos, durables, confiables, de fácil operación y bajo mantenimiento, que sean económicos y que se independicen del problema de compra en lugares alejados (incluida en casos la importación), transporte y almacenamiento de sustancias químicas utilizadas en la desinfección.

Tomado a nivel mundial, la OMS, UNICEF, el CEPIS, el IRC



y numerosas agencias de ayuda internacional han volcado no pocos esfuerzos en conseguir un sistema lo suficientemente confiable y que hiciera frente a los inconvenientes anotados.

En América, la OPS, a través de un programa de Tecnología Apropriada orientada desde su Oficina Central en Washington y contando con el apoyo del Programa de Naciones Unidas para el Desarrollo (PNUD) ha investigado un gran número de alternativas tecnológicas aplicables a la desinfección tales como hipocloración, ozonización, yoduración, radiación UV, así como la cloración

por gases, cloraminas, resinas halogenadas, dióxido de cloro, etc.

Hoy y gracias a este apoyo e iniciativa, parece haberse encontrado un sistema con las mejores posibilidades y que responde a las mayores expectativas: la ozonocloración con producción de gases in-situ.

Sabido es que la ozonización es una técnica de excelentes propiedades desinfectantes y que el uso del cloro aporta el residual indispensable para hacer frente a eventuales contaminaciones ocurridas entre el momento del tratamiento y el del uso del agua.

GIDOX, un exponente de esta



# desinfección

técnica, es un sistema que, en base a agua, aire, electricidad y sal común (sustancia disponible en cualquier lugar por alejado que esté), produce una mezcla de gases oxidantes cuyos principales componentes son ozono, peróxido de hidrógeno, cloro y dióxido de cloro.

Más en detalle, GIDOX es una celda de tipo electrolítico, dividida en dos semiceldas, que descompone la sal y el agua por el pasaje de electricidad de bajo voltaje comandada por un módulo de control electrónico que acompaña al equipo.

El proceso electrolítico produ-

ce en una semicelda dos subproductos que se descartan: hidróxido de sodio e hidrógeno; mientras que en la segunda semicelda se genera la mezcla oxidante la cual, conducida a través de una apropiada conexión, es introducida en el circuito del agua a tratar.

La instalación es sencilla: junto con el equipo se provee un venturi que absorbe los gases producidos en la celda y los inyecta en el torrente de agua. Este venturi debe colocarse en la cañería principal o en una derivación. La operación sólo requiere del agregado de sal y agua a la celda cuando sea necesario y la dilución del hidróxido de sodio que se va produciendo a medida que transcurre el proceso.

La tasa de generación de gas es comandada por la electrolisis, la que a su vez es controlada variando la corriente eléctrica que circula mediante el manejo de un dial en el módulo de control. (Este módulo permite también la incorporación de un buzzer para avisar a distancia si la celda carece de agua y, mediante conexión a un caudalímetro, la producción de gas según demanda de caudal.)

La desinfección óptima y por lo tanto la dosis ideal se consigue variando la producción de gases de forma de obtener en el lugar en que se desee el residual de cloro pretendido, lo que se verifica con el sencillo análisis de la ortotolidina.

Debido a que los gases oxidantes producidos en una unidad GIDOX se componen aproximadamente de un 70% de especies del oxígeno y un 30% de especies del cloro, se puede esperar obtener los mismos subproductos de desinfección que se obtienen cuando estos desinfectantes se utilizan por separado. Además, el ozono y los radicales libres del oxígeno reaccionarían con mayor

facilidad ante sustancias orgánicas que el cloro, dando como resultado un nivel significativamente menor de trihalometanos que el que se obtendría usando sólo el cloro. De manera similar, el oxígeno puede reaccionar con mayor facilidad que el cloro ante los fenoles y las algas debido a su afinidad por la materia orgánica, reduciendo con ello los problemas de sabor y de olor, así como la formación de compuestos organoclorados no deseados. Según la Organización Panamericana de la Salud(1) "Desde el punto de vista de salud pública, GIDOX debería resultar, por lo menos, tan beneficioso y seguro como el cloro". Por añadidura a la solución de problemas de contaminación microbiana, GIDOX también presenta la posibilidad de destruir sustancias oxidables tanto orgánicas como inorgánicas presentes en desagües cloacales e industriales, con un ventajoso comportamiento frente al cloro, tal como se desprende de experiencias verificadas en tratamientos paralelos GIDOX-cloro gas y que se presentan condensadas en los gráficos adjuntos.

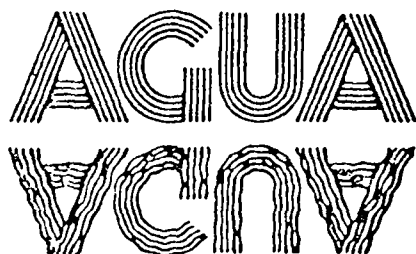
El rango de aplicación varía desde el uso familiar al tratamiento de agua de plantas potabilizadoras de hasta 10.000 habitantes por unidad, a lo que habrá que sumar afluentes y efluentes industriales, cloacales y piscinas de natación. El equipo GIDOX es producido en Argentina por FENAR S.A.

(1): Hojas de Divulgación Técnica - OPS/CEPIS - Nº 32 - 1986

NOTA: Figuras de este artículo en la página siguiente.

**Trabajo preparado por:**  
Ing. Sanit. Felipe Solsona  
FENAR S.A.  
Poysandú 2361  
Buenos Aires

Reproducido de



AÑO XIII - EDICION 50

MAYO DE 1987

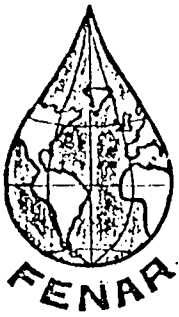
ISSN 0325 - 6235

Es una publicación de:



Producciones S.R.L.

Emilio Mitre 130  
1424 Buenos Aires  
Tel.: 432-5273  
República Argentina  
Registro Nacional  
de la Propiedad  
Intelectual  
Nº 35844  
Director: ,  
Horacio J. Bacot



## GIDOX 2

Por su gran rendimiento y bajo costo, este equipo es ideal para la desinfección de aguas de uso doméstico tales como las de viviendas familiares, edificios de departamentos, countries, hospitales, escuelas, piscinas, etc.

Debido a que este sistema produce ozono y cloro simultaneamente, se reducen los inconvenientes detectados cuando el cloro es el único desinfectante, ya que el ozono, con su mayor poder, destruye la materia orgánica y los amoniacaes presentes en el agua cruda, evitando la formación de cloraminas que otorgan sabor desagradable al agua y de trihalometanos, de probada acción cancerígena; permitiendo sin embargo la permanencia del cloro en el agua como prevención a futuras contaminaciones.

La producción de este equipo, estimada en 100 gramos de oxidante por día permite la desinfección de hasta 100 m<sup>3</sup> diarios (100 000 litros/día), lo que da posibilidad de desinfectar TODA el agua de consumo, que incluye la de preparación de alimentos, higiene personal, lavado de ropa, limpieza de ambientes, etc.

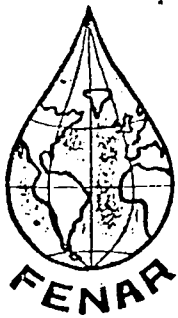
Este equipo se presenta en dos versiones:

GIDOX -2A                    consiste en un generador de gases con su correspondiente inyector y módulo de comando.

GIDOX -2B                    idem al anterior pero con una bomba de recirculación incorporada.

---

FENAR S.A.                    -                    Tecnología en Aguas



## COMO SELECCIONAR UN EQUIPO

### G I D O X - 2

Para la selección correcta de un equipo GIDOX -2 se deben conocer tres datos fundamentales:

1. Dosis de gases desinfectantes a agregar
2. Volumen de agua a tratar
3. Tiempo que debe operar el equipo

Si bien habría que efectuar un análisis químico para conocer con exactitud cual es la carga de contaminación de un agua (carga orgánica o demanda), se puede suponer que para un agua clara proveniente de una perforación o de un depósito limpio, la DOSIS de desinfectante a agregar a un agua cruda es del orden de 1 mg de oxidante/litro de agua (equivale a 1 gramo de desinfectante/m<sup>3</sup> de agua).

Otro dato importante a conocer es el volumen de agua a tratar por día. Esto es el volumen de TODA el agua que se usará en el edificio, establecimiento, etc. Con estos dos datos se puede obtener la cantidad de desinfectante necesario ya que:

$$\text{DOSIS} \times \text{VOLUMEN DE AGUA DIARIO} = \text{GRAMOS DE DESINFEC. NECESARIO POR DIA}$$

Conociendo la capacidad de producción del GIDOX -2 en gramos de oxidante/día que es igual a 100 gramos/día ó 100 g/24 horas, se puede calcular el tiempo necesario que el equipo deberá funcionar para producir tal cantidad:

$$\text{GRAMOS DESINF. POR DIA} \times 0,24 \text{ h/g} = \text{HORAS DE FUNCIONAMIENTO DEL EQUIPO}$$

Si el agua a tratar circula por el inyector un tiempo IGUAL o MAYOR que el tiempo establecido en el cálculo anterior, se deberá usar el GIDOX -2A.

En caso de que el agua circule un tiempo MENOR que el establecido por el cálculo, se deberá usar el GIDOX -2B.

Este último equipo viene provisto de una pequeña bomba independiente que permite el funcionamiento de aquel aún cuando se haya detenido la bomba principal que impulsa el agua al tanque o al sistema de distribución.

El tiempo extra que deberá funcionar el equipo se regula fácilmente por medio de un temporizador incorporado en el módulo de comando. Al término de ese tiempo extra, el módulo detiene automáticamente tanto el funcionamiento de la bomba auxiliar como el del equipo.

#### EJEMPLO:

Supongamos que se deba tratar un tanque de agua de un edificio de departamentos de 10 m<sup>3</sup>, el cual tiene una bomba que lo llena en 2 horas. El tanque es llenado 2 veces por día.

$$\text{VOLUMEN DE AGUA DIARIO A TRATAR} = 10 \text{ m}^3 \times 2 = 20 \text{ m}^3$$

$$\text{DOSIS} = 1 \text{ g desinfectante/m}^3$$

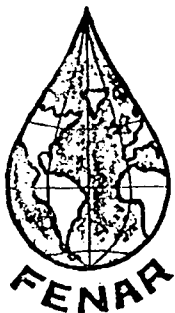
$$\text{GRAMOS DESINFEC. NECESARIOS POR DIA} = 20 \text{ m}^3 \times 1 \text{ g/m}^3 = 20 \text{ gramos}$$

$$\text{HORAS FUNCIONAMIENTO BOMBA PRINCIPAL} = 2 \text{ horas} \times 2 \text{ veces/día} = 4 \text{ horas/día}$$

$$\text{HORAS FUNCIONAMIENTO DEL EQUIPO} = 20 \text{ g} \times 0,24 \text{ hs/g} = 4,8 \text{ horas}$$

Dado que el valor necesario de tiempo de funcionamiento del GIDOX-2 supera al tiempo de funcionamiento de la bomba se debe usar entonces el GIDOX - 2B.

**FENAR S. A. - Tecnología en Aguas**



## CRITERIO PARA SELECCIONAR EQUIPOS GIDOX PARA NATATORIOS

Para la selección de los equipos GIDOX a ser usados en natatorios se deben tener en cuenta factores tales como: 1) volumen de la piscina, 2) tipo de agua, carga de bañistas, exposición a rayos del sol y polvo o tierra y 3) horas de recirculación del equipo filtrante.

En el punto 2) se toman tres tipos de natatorios, cada uno con una cantidad de oxidante a dosificar según el siguiente criterio.

Dosis = 1 g/m<sup>3</sup> de oxidante: Natatorios con agua en buen estado y buen sistema de filtración. Con poca carga de bañistas, poca exposición a polvo o tierra y con parte del día bajo sombra.

Dosis = 2 g/m<sup>3</sup> de oxidante: Natatorios con características intermedias

Dosis = 5 g/m<sup>3</sup> de oxidante: Natatorios con alta carga de bañistas, exposición a polvo o tierra y todo el día bajo sol.

Volumen natatorio = 25 m<sup>3</sup>

HORAS DE RECIRCULACION

	4	8	12	24	EQUIPO GIDOX	
DOSIS	1	G-5	G-2	G-2		G-2
	2	G-10	G-5	G-2		G-2
	5	G-30	G-10	G-10		G-5

Volumen = 50 m<sup>3</sup>

	4	8	12	24
1	G-10	G-5	G-2	G-2
2	G-15	G-10	G-5	G-2
5	2xG-30	G-30	G-15	G-10

Volumen = 100 m<sup>3</sup>

	4	8	12	24
1	G-30	G-10'	G-5	G-2
2	2xG-30	G-30	G-10	G-5
5	4xG-30	2xG-30	G-30	G-15

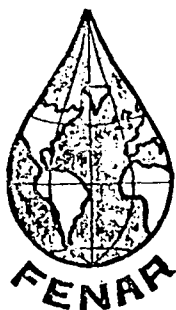
Volumen = 200 m<sup>3</sup>

	4	8	12	24
1	2xG-30	G-30	G-10	G-5
2	4xG-30	2xG-30	G-30	G-10
5		4xG-30	2xG-30	G-30

Volumen = 500 m<sup>3</sup>

	4	8	12	24
1	4xG-30	2xG-30	G-30	G-15
2		4xG-30	2xG-30	G-30
5				3xG-30

**FENAR S. A. - Tecnología en Aguas**



## GIDOX EN LA INDUSTRIA

Uno de los graves problemas que enfrenta la Humanidad en la actualidad es la contaminación del medio ambiente.

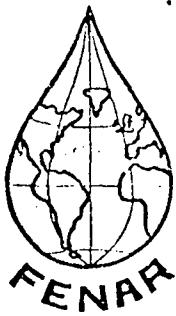
En particular, la contaminación de las aguas es un hecho que preocupa a las autoridades de los países por su magnitud y el origen de sus causas. Entre estas últimas pueden citarse:

- Falta de legislación apropiada y dificultad en la aplicación de la misma.
- Desconocimiento y/o desinterés en aportar medidas de solución por parte de los industriales.
- Falta de equipos o sistemas económicos, de bajo costo de operación y mantenimiento y sencillez de funcionamiento compatibles con los costos industriales.

Sin pretender ser la solución total de cualquier problema de efluentes, el sistema GIDOX aporta una notable sencillez de uso a la vez que una excelente capacidad de tratamiento en todo desague industrial que requiera una oxidación enérgica y que esté compuesto por cianuros, fenoles, amoniacales, orgánicos en general, detergentes, herbicidas, plaguicidas, inorgánicos oxidables, materiales patógenos, etc.

Por sus bondades y costos tanto de adquisición como de operación, GIDOX es el más adecuado para su uso en toda industria con efluentes líquidos de alto riesgo.

FENAR S. A. - Tecnología en Aguas



## GIDOX Y EL AGUA POTABLE

---

Según la Organización Mundial de la Salud, en la actualidad 8 de cada 10 camas en todos los hospitales del mundo están ocupadas por enfermos relacionados directa o indirectamente con el agua que consumen.

Nuestro país no es una excepción, y en la mayoría de las áreas rurales, la principal causa de morbi-mortalidad infantil es la diarrea y las infecciones gastrointestinales de origen hídrico.

Existen leyes y normas que precisan la necesidad de la desinfección de las aguas que se entregan a la población, pero ellas no se cumplen debido principalmente a una serie de factores entre los que figuran:

- = Falta de conocimiento de los niveles de decisión política de la magnitud totalidad y complejidad del problema.
- = Falla en reconocer el riesgo sanitario por parte de la población.
- = Falta de equipos de desinfección en plantas potabilizadoras que cumplan con:
  - Costo reducido de inversión
  - Costo reducido de operación
  - Sencillez de operación y mantenimiento
  - Independencia de la compra, traslado y almacenamiento de peligrosas sustancias químicas

FENAR SA, una empresa argentina cuyos profesionales, consultores de organizaciones de salud internacionales que conocen el problema y lo han estudiado tanto en sus causas como en sus soluciones, presenta la línea GIDOX, equipos de ozono-cloración con producción de gases in-situ, que cumple con la totalidad de los requisitos de un equipo de desinfección ideal y que son los anotados precedentemente.

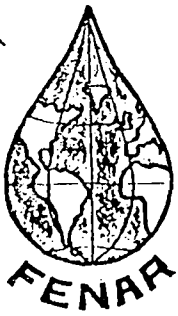
Porque GIDOX es algo más que un equipo de desinfección.

Es un sistema que garantiza la calidad del agua que se entrega a la población no solo por las sustancias altamente desinfectantes que genera, sino por la suma de virtudes que hacen a la operación y manejo del equipo y en forma especial al hecho de no requerir del auxilio de compuestos químicos costosos y peligrosos de manejar. Tan solo electricidad, agua y sal común.

Es por ello que la Organización Panamericana de la Salud ha expresado públicamente su apoyo a este sistema, y es su esperanza que aquellos que tienen poder de decisión en la adquisición y/o uso de estos equipos oigan el llamado y coadyuven para solucionar uno de los grandes problemas de la Humanidad, que no por antiguo deja de ser menos angustiante y grave.

---

FENAR S. A. - Tecnología en Aguas



## MODULOS DE COMANDO GIDOX

Los módulos de comando de los equipos GIDOX para ozonocloración de aguas, tienen por objeto controlar la corriente que circula por las celdas electrolíticas, gobernando así la producción de las mismas.

Los distintos tipos de modelos disponibles, permiten también el acceso a una serie de funciones auxiliares.

Los equipos standard van alimentados con tensión de red, corriente alterna, de 220 V ó 110 V según pedido, pudiendo suministrarse módulos especiales que funcionen con otro tipo de alimentación.

El MODULO C-1 es una fuente de alimentación con dos valores fijos de corriente (100 % y 50 %), que corresponden a la producción máxima nominal del equipo y a su mitad.

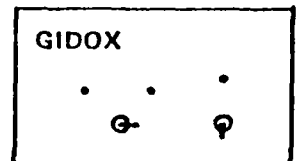
Estos módulos son aptos para instalaciones donde no se requiera un ajuste exacto de la producción, pudiendo regularse la dosificación ya sea controlando el tiempo de funcionamiento del equipo, o bien el caudal de agua. También sirve para el caso en que estén operando en paralelo más de un equipo, donde algunos son de valor fijo (usan el módulo C-1) y otros son de ajuste (usan módulo C-2 ó C-3).

El MODULO C-2 permite el control continuo de la corriente, pudiendo de esa forma ajustarse la dosificación desde cero hasta el valor máximo nominal.

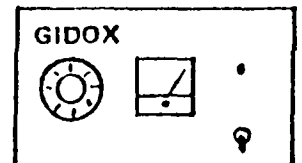
Debido al tipo de sistema de control, éste es muy apto para instalaciones en las que las variaciones de tensión de línea sean muy amplias.

El MODULO C-3, que también controla desde el cero al 100 %, es un acabado sistema de control electrónico, lo que le confiere una gran solidez mecánica y larga vida útil. Tiene un display a leds, lo que permite una rápida visualización del estado del equipo. Con el objeto de acelerar la entrada en régimen inicial, cuenta con un subsistema de sobrealimentación eléctrica. Informa la falta de nivel de agua en la celda tanto visual (luz) como con alarma sónica - buzzer- (opcional). Asimismo posee un sistema realimentado que estabiliza la corriente al valor deseado frente a variaciones de parámetros externos. Admite variaciones de tensión de línea de hasta el 20 % y cuenta con la posibilidad de dosificar según demanda de caudal (opcional).

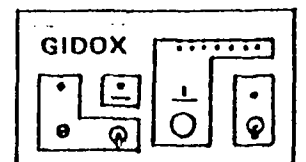
### C-1



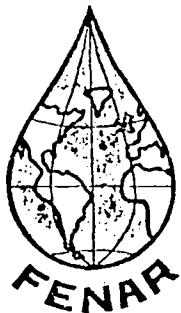
### C-2



### C-3



FENAR S. A. - Tecnología en Aguas



---

SELECCION DE EQUIPOS GIDOX  
SEGUN CAUDAL A TRATAR  
PARA AGUA POTABLE

HASTA CAUDAL  
(m<sup>3</sup> / h)

MODELO

4	G-2
8	G-5
16	G-10
23	G-15
45	G-30

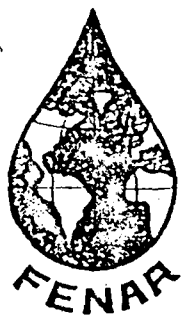
FENAR S. A. - Tecnologia en Aguas

ESTOMBA 1949  
Administración y Ventas: PAYSANDU 2361

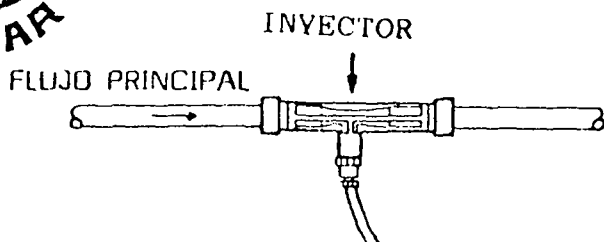
TEL. 59-2154

(1416) BUENOS AIRES  
ARGENTINA

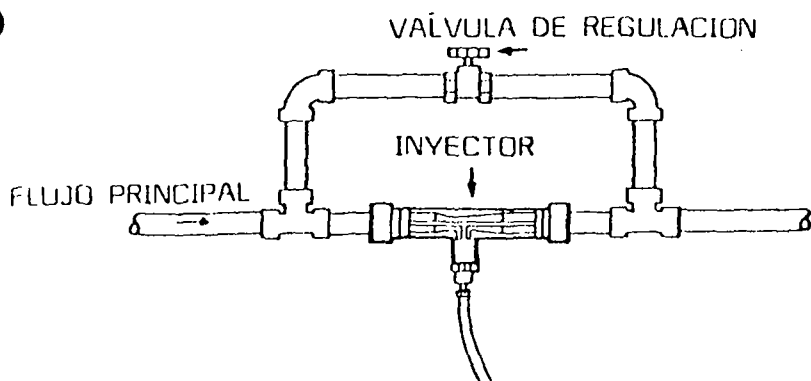




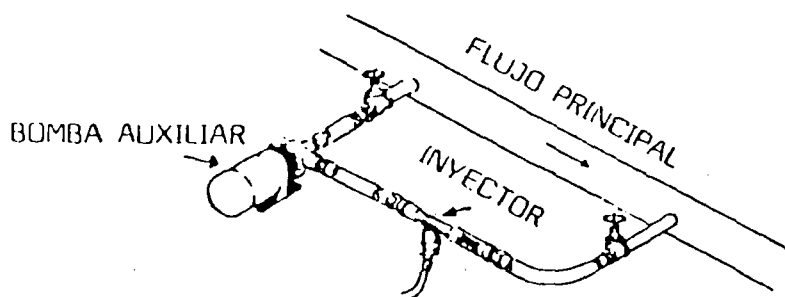
## INSTALACION HIDRAULICA DEL GIDOX



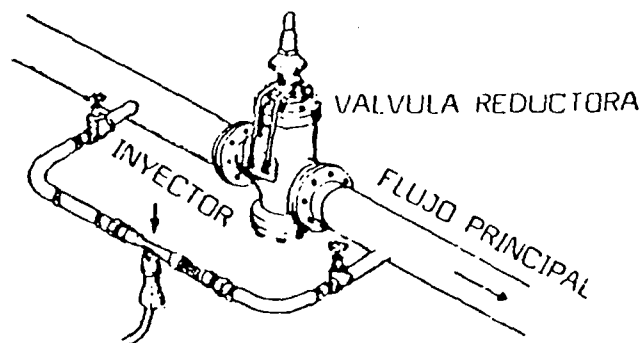
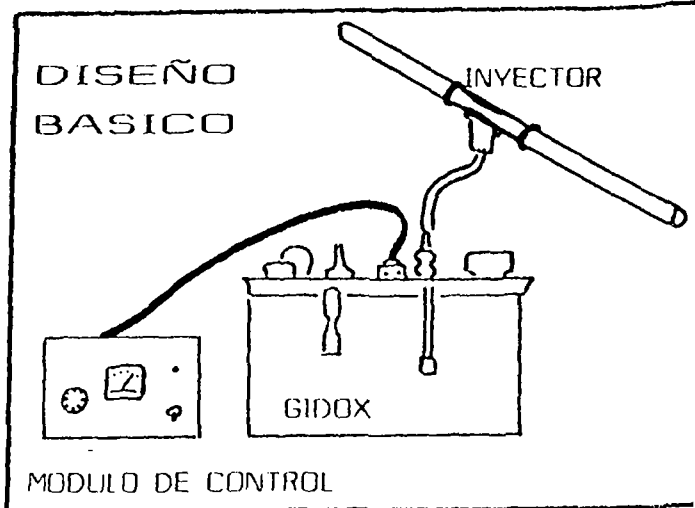
Es la instalación básica y es ideal para tuberías de bajo diámetro y donde no circule demasiado caudal.



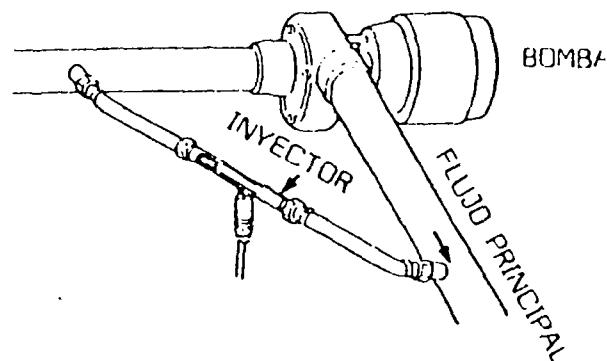
Este esquema es ideal cuando no se desee una pérdida de carga muy grande y cuando la tubería principal sea de diámetro pequeño.



El uso de una bomba auxiliar permite independizarse del sistema en donde se inyecta, y tiene la ventaja de posibilitar tanto la reinyección de agua con los gases en la misma tubería como en un tanque o canal.



Esta configuración puede usarse cuando la tubería principal es de diámetro grande. La derivación se debe armar alrededor de una válvula existente y en caso de que no la hubiere, se deberá intercalar una.

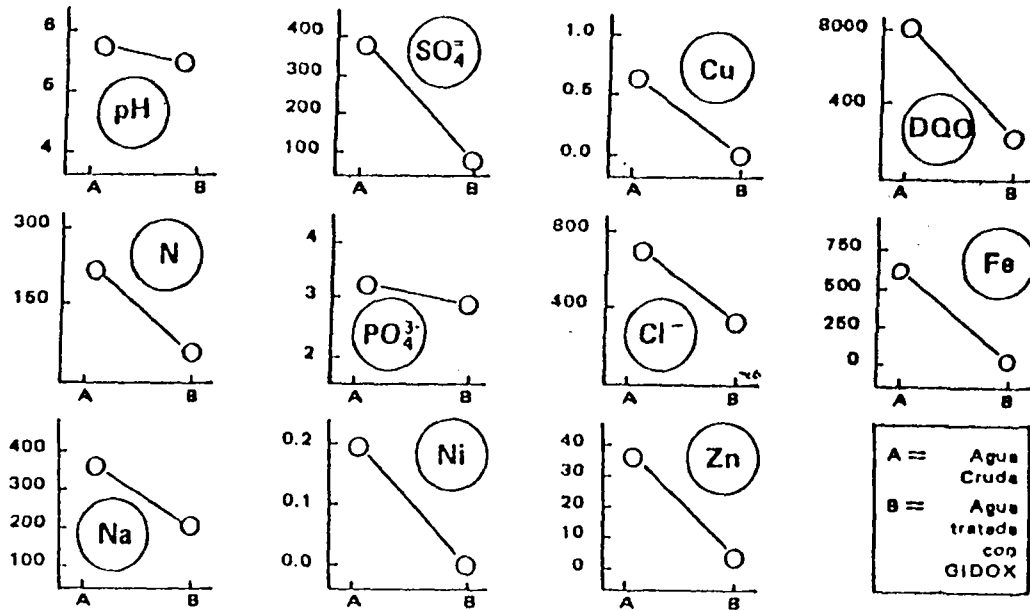


Esta configuración es excelente cuando se tiene fácil acceso a una bomba impulsora instalada en el sistema.

FENAR S. A. - Tecnología en Aguas

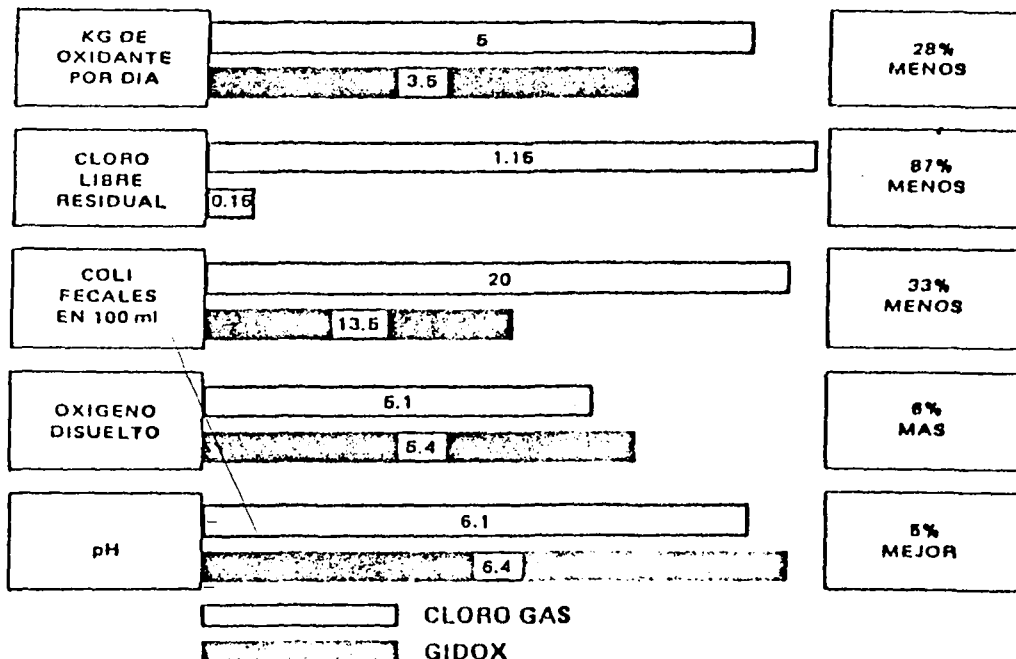
# desinfección

## MODIFICACION POR ACCION DEL GIDOX APLICADO A UN EFLUENTE INDUSTRIAL CONTAMINADO



(Valores en mg/l, excepto para pH)

## ANALISIS COMPARATIVO DEL TRATAMIENTO CON CLORO GAS Y CON "GIDOX" A UN MISMO EFLUENTE CLOACAL





## PLANTAS COMPACTAS POTABILIZADORAS

PCP-1                      PCP-5

La PCP es una línea de equipos modulares, con capacidades de producción de hasta 5 m<sup>3</sup> de agua potabilizada/hora.

El tratamiento del líquido se produce según la secuencia tradicional de Ingreso-dosificación de coagulante-floculación-decantación-filtración-desinfección.

Sin embargo, la modificación de algunos parámetros y la adopción de nuevos equipos permiten en las PCP las mejores calidades físico-químicas y bacteriológicas en el agua efluente a la vez que un reducido espacio ocupado.

Si se parte de aguas superficiales con elevados tenores de turbiedad: el sistema de remoción de la misma a partir del uso de coagulantes comunes y de un decantador de flujo horizontal ascendente con sediplacas incorporadas, se efectúa con altísima eficiencia obteniéndose un producto limpio y cristalino.

Si el agua en cambio es dura o salina, el equipo permite la incorporación, siempre dentro del esquema general, de un ablandador o de un desmineralizador, los que actuando bajo la técnica del intercambio iónico eliminan la carga salina. El ablandador o el desmineralizador son optativos.

La filtración, otra importante etapa del tratamiento, se realiza en un filtro de grava y arenas silíceas, pero si el caso lo requiriera, se puede incorporar al mismo una capa de carbón activado lo que eliminaría también cualquier problema de gusto u olor.

La etapa final del tratamiento, la desinfección, se realiza con el auxilio de un equipo GIDOX, celda productora de ozono y cloro a partir de agua y sal común de mesa. Tal mezcla oxidante garantiza no solo un sabor agradable en el agua, sino y muy especialmente la completa y segura ausencia de gérmenes patógenos.

Pueden resumirse las características de las PCP asegurando que se trata de los más compactos, seguros, simples de operar y mantener, económicos y de alta performance sistemas productores de agua potable, ideales para el medio rural, o para grupo de viviendas, pequeñas poblaciones, escuelas, puestos sanitarios, hospitales, obradores, clubes, countries, fábricas, y aún como plantas móviles para casos de catástrofe, inundación, etc.

FENAR S. A.                      -                      Tecnología en Aguas



**CARACTERISTICAS DE LOS ELEMENTOS  
CONSTITUTIVOS DE LAS PCP**

**DOSIFICADOR DE CUAGULANTE.** Se trata de un depósito de polietileno, con regulación por válvula inferior y dosificación a gotas por inyección en la aspiración de la bomba, lo que facilita la homogénea y perfecta dispersión del coagulante empleado.

**FLOCULADOR.** De accionamiento hidráulico que permite velocidades decrecientes, lo que favorece la formación de coágulos de tamaño apropiados para la decantación. El floculador está integrado al sistema floculador/decantador.

**DECANTADOR.** Posee una cámara compensada para distribución laminar del flujo de ingreso. Cuenta con placas especiales inclinadas en un ángulo prefijado para obtener por una parte la mayor tasa de intercambio y por consiguiente de sedimentación de las partículas de turbiedad, y por otra, un eficiente acción de autolimpieza, lo que facilita su utilización.

**FILTRO.** De cuarzo de dos granulometrías diferentes; con colector plástico de alto impacto; esferas filtrantes roturadas de gran dureza, con manómetro incorporado y purga de aire.

**ABLANDADOR/DESMINERALIZADOR.** Actúa bajo el principio del intercambio iónico, con resinas especiales sintéticas que permiten la eliminación de la carga salina. Este equipo es optativo, si el caso lo requiriera.

**DESINFECCION.** La desinfección está provista por la acción de un equipo GIDUX; sistema único en su género y aconsejado por la Organización Mundial de la Salud. Produce ozono y cloro a partir de agua y sal común seca. La mezcla de gases oxidantes generada por el equipo asegura la total eliminación de bacterias patógenas en el agua efluente de la planta.

**BOMBA.** De tipo centrífuga, horizontal en unblock. Según requerimiento se provee en 12, 220 ó 380 Volts, 50 Hz.

**CUADRO DE VALVULAS Y SISTEMA DE INTERCONEXION.** Todas las cañerías, accesorios y válvulas son de PVC ó de Polipropileno y se presentan en cuadros de manobra de fácil visualización y accionamiento.

**CARACTERISTICAS CONSTRUCTIVAS DEL FLOCULADOR/DECANTADOR, FILTRO Y ABLANDADOR/DESMINERALIZADOR.** Los elementos mencionados están todos confeccionados en chapa de acero al carbono 1010/1020, con cabezales esféricos con bridas abulonadas y tratados con resinas epoxi previo arenado y fosfatizado; lo que asegura una muy larga vida a las plantas a la vez que una elevada robustez y resistencia a los agentes internos y externos.

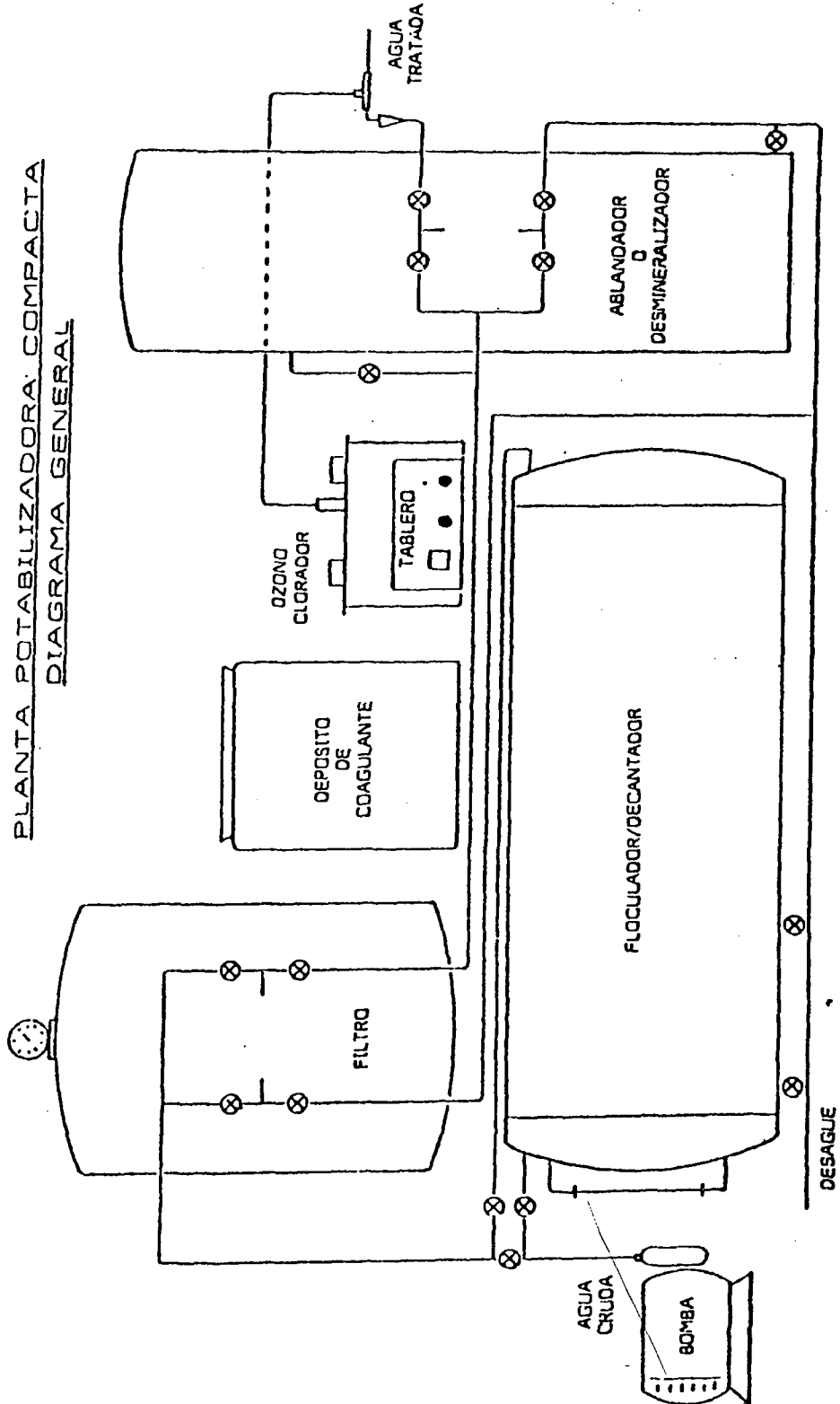
Todo el conjunto se presenta montado en terreno lo que permite su fácil ubicación definitiva ó el traslado sin necesidad de desarme ó pérdida de tiempo.

MODELO	CAUDAL (m <sup>3</sup> /H)	DIMENSIONES (m) *			PESO (Kg)		
		Largo	Ancho	Alto	Vacío	C/carga	En trabajo
PCP-1	1	1.50	0.45	1.8	55	110	250
PCP-5	5	1.80	0.80	1.8	145	230	950

\*con ablandador incluido



PLANTA POTABILIZADORA COMPACTA  
DIAGRAMA GENERAL

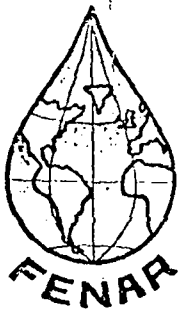


FENAR S. A. - Tecnología en Aguas

ESTOMBA 1949  
Administración y Ventas: PAYSANDU 2361

TEL. 59-2154

(1416) BUENOS AIRES  
ARGENTINA



---

## PLANTA DEPURADORA DE LIQUIDOS CLOACALES

### DESCRIPCION

Planta depuradora que a través de un tratamiento integral del líquido cloacal, permite obtener un efluente cuyas características de alta limpieza, baja DBO y ausencia de gérmenes patógenos, es fácilmente disponible en cualquier curso o terreno.

La planta cuenta con secciones que aunque individuales están integradas en un todo, haciendo a la misma fácil de operar y mantener a través de una total automatización.

### ELEMENTOS CONSTITUYENTES

La planta cuenta con los siguientes elementos de acuerdo al camino que recorre el líquido a tratar:

- Cámara de entrada del líquido cloacal
- Concentrador de sólidos por reja manual o automática
- Cámara de bombeo
- Difusor presurizado
- Sedimentador primario
- Turboeyector
- Primera cámara de barros activados
- Canaleta de eliminación de espumas y recirculación
- Segunda cámara de barros activados
- Dispersor de coagulante
- Floculador
- Sedimentador secundario
- Filtro
- Desinfección por ozono-cloración

---

FENAR S. A. - Tecnología en Aguas



# VENTAJAS DEL SISTEMA FENAR SOBRE LOS CONVENCIONALES EN EL TRATAMIENTO DE CLOACALES

## SISTEMA CONVENCIONAL

## SISTEMA FENAR

### ESPACIO REQUERIDO

Las plantas de tratamiento de efluentes convencionales fueron diseñadas tratando de lograr capacidades y espejos de agua importantes para obtener mejores oxigenaciones y tiempos de permanencia hasta llegar a la degradación biológica por medio de flora aeróbica. Esto demanda obras civiles de envergadura con el consiguiente gasto de espacio.

Las obras civiles requeridas por nuestro sistema de depuración se reducen a una plataforma de apoyo por los estanques metálicos más dos cámaras de recepción de líquidos.

Como ejemplo: para una población que con un sistema convencional requiera 400 m<sup>2</sup>, el sistema FENAR solo necesita 160 m<sup>2</sup>.

### COSTOS

Los costos de esta infraestructura son realmente elevados debido a los estudios de suelo previos a la construcción, evacuación de aguas surgentes donde las hubiere; basamento para las mismas y costos de la obra estructural.

Los costos de infraestructura son reducidos pues no requieren basamento ni espacios importantes.

### TIEMPO DE EJECUCION DE LA OBRA

Los tiempos de ejecución de obra son apreciables aún para empresas de alta capacidad técnica.

Los tiempos de ejecución de obra se reducen notablemente pues los estanques metálicos están conformados por paneles plegados prefabricados, los que son de muy fácil montaje en el lugar de la obra.

### CONSUMO DE ENERGIA

Elementos electromecánicos de gran peso, construcciones rudimentarias con grandes insumos de energía.

Los elementos electromecánicos (aeradores, concentradores, motobombas) son de reducido tamaño y fabricados con tecnología de precisión, siendo el consumo de energía eléctrica requerido, un tercio de los sistemas convencionales

**FENAR S. A. - Tecnología en Aguas**



## EQUIPOS

### BOMBAS

De eje vertical o sumergibles según el caso. De baja presión, alto caudal y rotores semiabiertos para evitar obstrucciones.

### DIFUSOR PRESURIZADO

De acción descendente que permite una rápida y efectiva mezcla del líquido ingresante con los barros activados.

### TURBOEYECTORES

De diseño especial, permiten el desmenuzamiento veloz de los sólidos orgánicos para facilitar su degradación, a la vez que incorpora grandes masas de oxígeno al líquido cloacal.

### DISPERSOR

A motor con eje vertical y 3 vueltas por minuto. Con dosificación del floculante por medio de un conducto eje-central.

### SEDIMENTADOR

De bajo volumen y alta capacidad debido a la disposición de sediplacas oblicuas.

### FILTRO

Abierto de grava y arena; con lavado realizado como en los filtros rápidos convencionales.

### OZONOCOLORADOR

Celda GIDOX para dosificación de gases oxidantes compuestos por ozono y cloro, lo que permite un ajuste fino del proceso oxidante, a la vez que asegura la eliminación completa de los gérmenes patógenos.

## MATERIALES

Hasta 30 m<sup>3</sup>/h se presentan plantas confeccionadas en hierro, plegado, lo que simplifica la instalación y reduce los costos de inversión inicial.

Para caudales mayores se confeccionan módulos en H<sup>2</sup>A<sup>2</sup> y mampostería.

## CONSUMO ENERGETICO

Hasta 30 m<sup>3</sup>/h aproximadamente 1 HP/m<sup>3</sup> tratado.

## CAPACIDADES

Desde 5 m<sup>3</sup>/día en más.

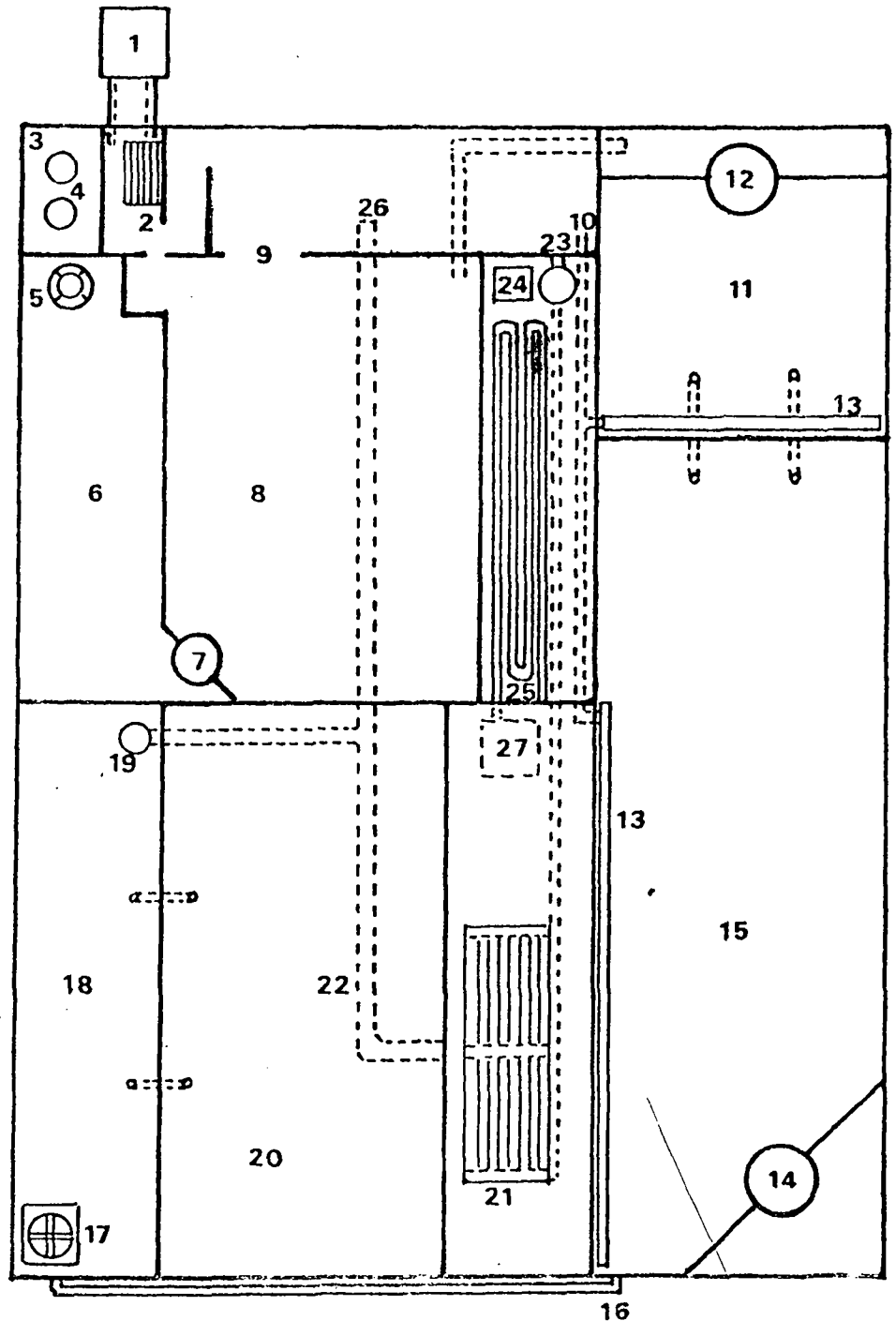
FENAR S. A. - Tecnología en Aguas





## PLANTA DEPURADORA DE LIQUIDOS CLOACALES

- 1. Cámara de entrada del efluente
- 2. Concentrador de sólidos
- 3. Cámara de bombeo
- 4. Bombas
- 5. Difusor presurizado
- 6. Sedimentador primario
- 7. Turboeyector
- 8. Primera etapa de oxidación
- 9. Retorno de sólidos flotantes
- 10. Conducto retorno de pescadores
- 11. Segunda etapa de oxidación
- 13. Turboeyector
- 14. Turboeyector
- 15. Tercera etapa de oxidación
- 16. Conducto al floculador
- 17. Floculador
- 18. Cámara de floculado
- 19. Bomba para sólidos sedimentados
- 20. Sedimentador secundario
- 21. Filtro de grava y arena
- 22. Colector de lodos y contralavado
- 23. Bomba para lavado del filtro
- 24. Ozono-clorador
- 25. Laberinto mezcla desinfectante
- 26. Cámara de lodos
- 27. Cámara de salida y tomamuestras



FENAR S. A. - Tecnología en Aguas.

EVALUACION PRACTICA DEL PODER  
BACTERICIDA DE LA OZONOCLORACION  
SOBRE AGUA GASIFICADA

Dr. Omar J. Simoni

Buenos Aires, Argentina, octubre de 1987

EVALUACION PRACTICA DEL PODER  
BACTERICIDA DE LA OZONOCOLORACION  
SOBRE AGUA GASIFICADA

Dr. OMAR J. SIMONI

- Director del ECCA - Estudio Consultor en Contaminación Ambiental, Maturin 2887, Buenos Aires, Argentina
- Asesor Técnico de la Federación Argentina de Aguas Gaseosas y Bebidas sin Alcohol.
- Director Técnico de CIMES - Control Integral Metodológico de Sodas, Argentina

SUMMARY

This work is related to the evaluation of the disinfecting power of a GIDOX ozonochlorination cell, in a series of gasified water bottles containing Faecal Coliform and Pseudomona Aeruginosa bacteria cultures.

From the final evaluation it can be concluded that the experience proved to be effective for complete immediate removal of F.C. and complete P.A. elimination after 24 hours of treatment, when using water highly contaminated.

INTRODUCCION

El trabajo consiste en la evaluación bacteriológica para obtener el poder bactericida de la ozonocloración, cuando ésta se aplica in-situ sobre envases con agua gasificada -sifones- en líneas de trabajo, actuando sobre la producción directa, previamente contaminada con cepas de Coliformes Fecales y de Pseudomonas Aeruginosas; con mediciones de oxidante.

Para el estudio se contó con un equipo GIDOX-10 producido por la firma FENAR S.A. de Argentina y la colaboración de la Sodería LA MARINA, Andrés Argibel 2860, Buenos Aires, que brindó sus instalaciones.

### TECNICA DE EVALUACION

Se dispuso de 17 envases limpios y se procedió a su desarme manual, inoculándose en cada uno de ellos 50 ml de un cultivo rico en Coliformes Fecales y 50 ml de otro cultivo rico en Pseudomona Aeruginosa, preparados según las técnicas bacteriológicas corrientes de aislamiento de cepas, con posterior enriquecimiento.

Los envases, perfectamente individualizados del 1 al 15 se colocaron en la línea de trabajo usual, retirándose los números 16 y 17 para servir como testigos.

El agua de llenado de los sifones, fue la utilizada en la operación diaria y que sufre el tratamiento de pasaje a través de un filtro de arena y otro de carbón activado; con el agregado en la ocasión de la prueba de los gases oxidantes producidos por el equipo GIDOX; los que fueron inyectados en el efluente del último de los filtros, antes de un pequeño tanque pulmón, con tiempo de permanencia de 5 minutos. Del tanque por tubería de 1½" y longitud de 7 metros el agua es conducida a las máquinas carbonatadora y llenadora.

Los sifones fueron llenados según la operación normal de trabajo, efectuándose un dosaje de cloro libre en el conducto mencionado, verificándose en mediciones constantes el valor de 4 mg/l.

Una vez en el laboratorio del ECCA se llenaron los envases 16 y 17 con agua estéril y junto con las muestras de la prueba fueron analizadas bacteriológicamente por el método de la membrana filtrante, según la técnica del Standard Methods for the Examination of Water and Wastewater, 16th Ed.

### RESULTADOS

Los resultados mostraron ausencia total de Coliformes Fecales en todas las muestras y solamente uno de los envases acusó una cuenta para Pseudomona Aeruginosa (ver Tabla 1).

Por ésta razón y luego de 24 horas de reposo a temperatura ambiente, se procedió a realizar un nuevo dosaje de cloro y se repitió el análisis bacteriológico de la muestra Nº 11, obteniéndose en este segundo análisis los siguientes resultados:

<u>Cloro residual</u>	menor que 0.2 mg/l	-
<u>Pseud. Aeruginosa</u>	0	-

### CONCLUSIONES

Los analisis evaluados permiten verificar -para los ensayos realizados- la eficiencia bactericida del ozonoclorador GIDOX cuando utilizado en aguas de bebida gasificada.

Buenos Aires, Argentina, octubre de 1987.

TABLA 1. Resultados de los análisis efectuados

<u>MUESTRA Nº</u>	<u>COLIFECALES</u> <u>(b/100ml)</u>	<u>PSEU. AERUG.</u> <u>(b/100ml)</u>	<u>CLORO RESIDUAL</u> <u>(mg/l)</u>
1	0	0	0.5
2	0	0	0.5
3	0	0	0.5
4	0	0	0.5
5	0	0	0.5
6	0	0	0.5
7	0	0	0.5
8	0	0	0.5
9	0	0	0.7
10	0	0	1.2
11	0	34	0.6
12	0	0	0.5
13	0	0	0.3
14	0	0	0.5
15	0	0	0.5
16	Incontables	Incontables	-
17	Incontables	Incontables	-

MANUAL DE OPERACIONES Y MANTENIMIENTO PARA EI. MOGGOD

Agosto de 1987

# INDICE

Sección	Página
INTRODUCCION.....	1
ANTECEDENTES - FUNCIONAMIENTO DE LA UNIDAD.....	2
GENERADOR DE DESINFECTANTE.....	3
I.    COSTADO DEL ANODO.....	4
II.   COSTADO DEL CATODO.....	5
III.  LA MEMBRANA.....	6
SEGURIDAD.....	7
MATERIALES NECESARIOS.....	8
LISTA DE VERIFICACION PARA OPERACIONES Y MANTENIMIENTO.....	10
COMO LLEVAR A CABO LA PRUEBA DEL HIDROMETRO.....	13
LIMPIEZA MENSUAL.....	15
PUESTA EN FUNCIONAMIENTO.....	25
REPARACION DEL GENERADOR DE DESINFECTANTE.....	29
REPARACION DE DESPERFECTOS.....	30
GRAFICA DE LA REPARACION DE DESPERFECTOS.....	32
CAMBIO DE FUSIBLE EN EL REGULADOR DE POTENCIA.....	34
REEMPLAZO DE LA MEMBRANA.....	35
REFEMPLAZO DE LAS BARRAS DEL ANODO Y CATODO.....	37
ALMACENAMIENTO.....	41
POSIBLES UTILIZACIONES DEL EXCEDENTE DE HIDROXIDO DE SODIO.....	42



## INTRODUCCION

El propósito de este manual es ayudarle a operar la unidad MOGGOD (Gases oxidantes mezclados generados insitus) y mantenerla en buen funcionamiento por medio de actividades de mantenimiento regulares y reparaciones básicas. El mantenimiento regular le permitirá mantener un nivel de desinfectante apropiado en su sistema hídrico, para poder alcanzar los mayores beneficios de salubridad.

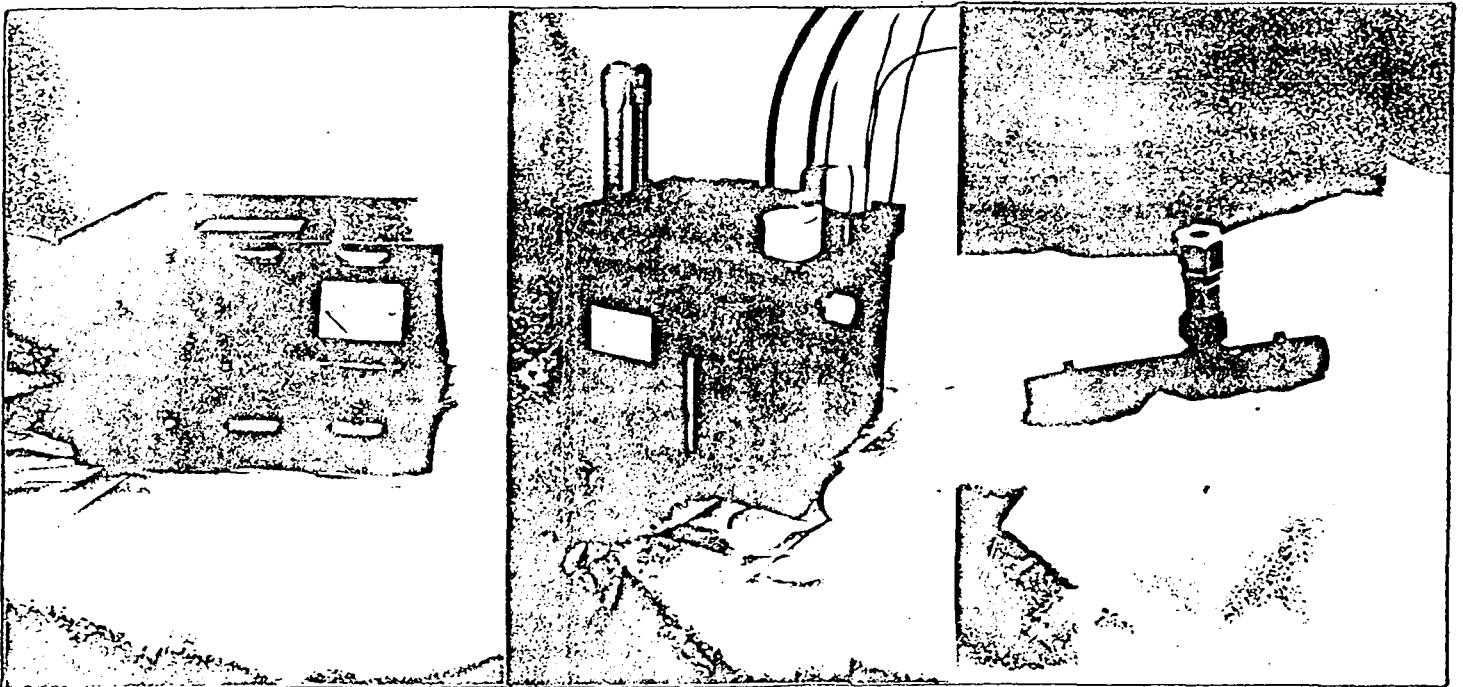
Este manual está basado en la unidad OXI de dos libras (un kilogramo), que en la actualidad es el modelo MOGGOD más comúnmente disponible y ampliamente utilizado. Hay cuatro tamaños diferentes de las unidades MOGGOD disponibles. Cada unidad puede desinfectar los sistemas hídricos que benefician hasta 20.000 personas.

## ANTECEDENTES

### FUNCIONAMIENTO DE LA UNIDAD

El sistema desinfectante de MOGGOD tiene tres componentes principales:

1. Regulador de potencia - controla la cantidad del flujo de electricidad a través del generador de desinfectante.
2. El generador de desinfectante - produce los gases desinfectantes.
3. El tubo de Venturi - conecta al generador de desinfectante con la fuente de agua y crea un vacío que absorbe los gases desinfectantes hacia la fuente de agua.



Regulador de potencia

Generador de desinfectante

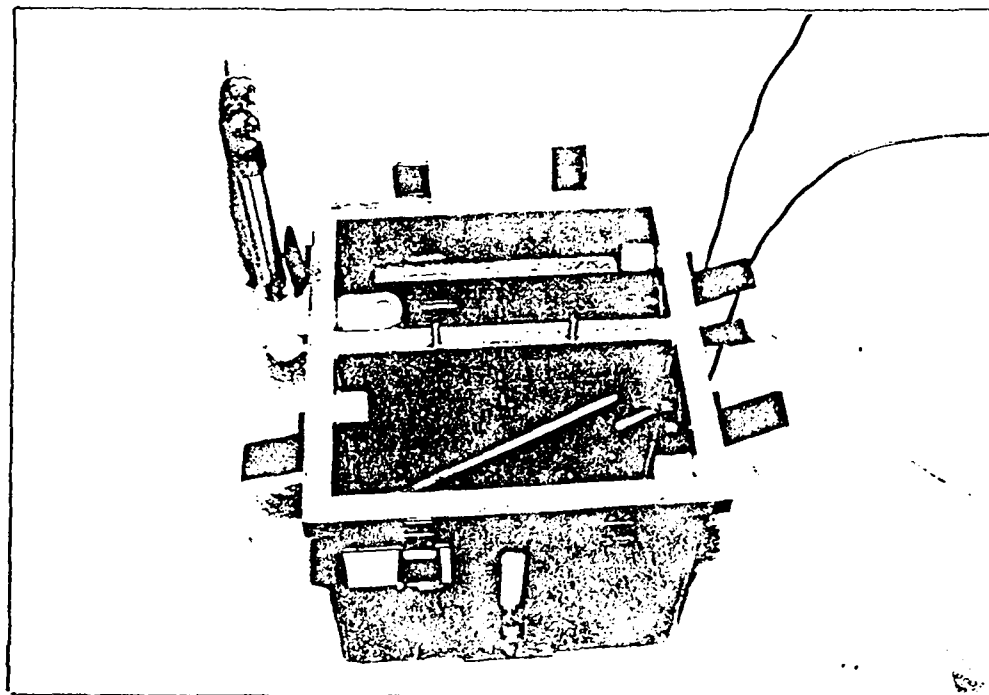
Tubo de Venturi

El sistema de MOGCOD simplemente convierte una solución saturada de agua salada en una mezcla de gases desinfectantes poderosos mediante el uso de la electricidad. El regulador de potencia controla la proporción (cantidad) de desinfectante producido, para medir con exactitud las necesidades de desinfectante del sistema hídrico. El tubo de Venturi se utiliza para inyectar la mezcla de gases desinfectantes en el sistema hídrico.

Antes de intentar la instalación u operación, el usuario debe familiarizarse con cada uno de los componentes, particularmente con el generador de desinfectante.

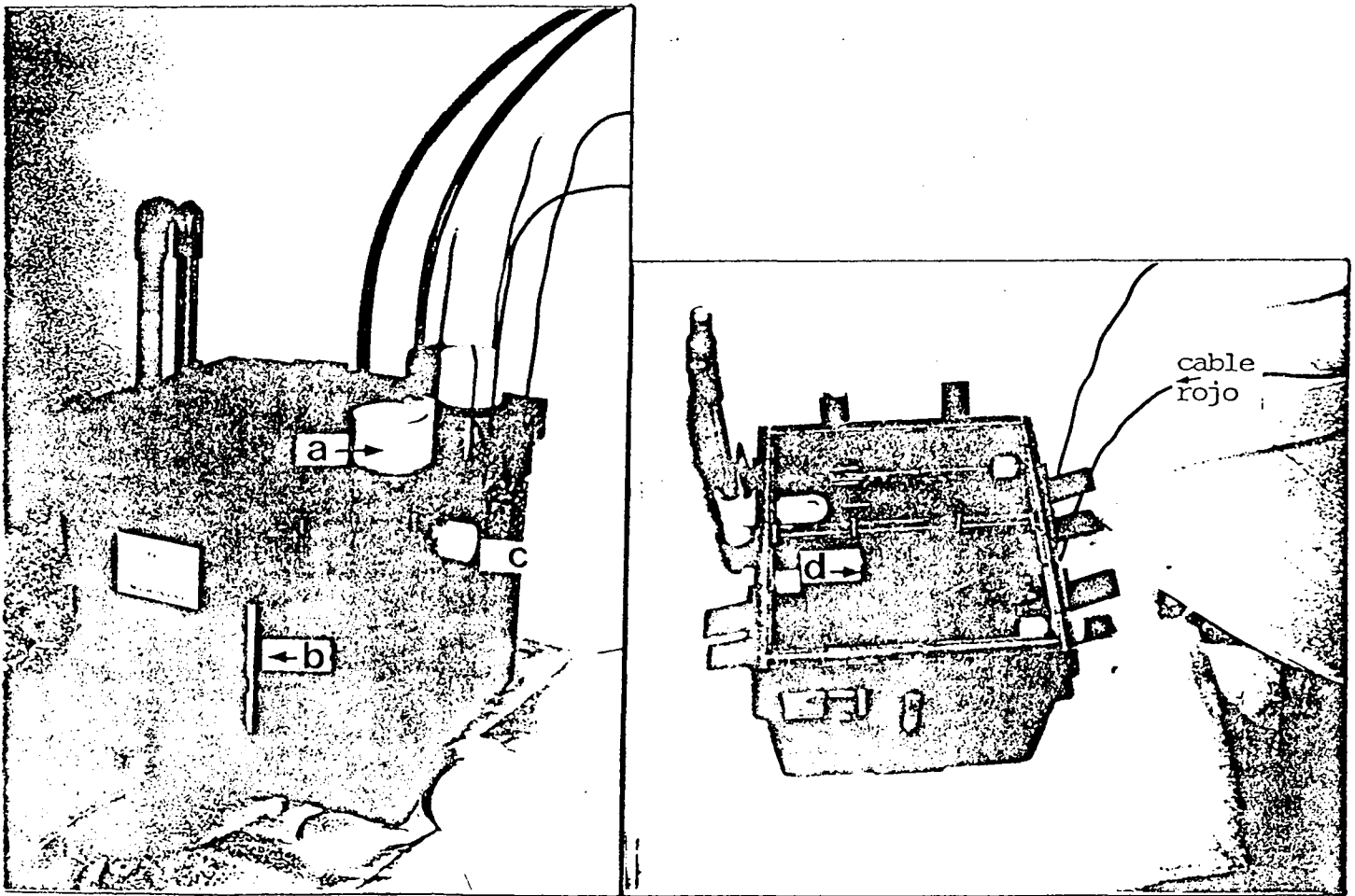
#### GENERADOR DE DESINFECTANTE

El generador de desinfectante es una caja de plástico dividida en dos celdillas, el ánodo (rojo) y el cátodo (negro).



Vista superior de un generador de desinfectante abierto

- I. El costado anódico produce los gases desinfectantes. Puede reconocerse por una tapa grande y el cable rojo conectado a la misma.
- a. Tanto la sal como el agua pasan por el agujero cubierto por la tapa grande.
  - b. La ventanilla de observación muestra los niveles de sal y de agua.
  - c. Las aberturas de rebose permiten la salida de cualquier exceso de agua salada.
  - d. Anodos: barras de metal (titanio), las cuales atraen a los oxidantes de desinfección (los cuales se convierten en gases) de la solución de sal.

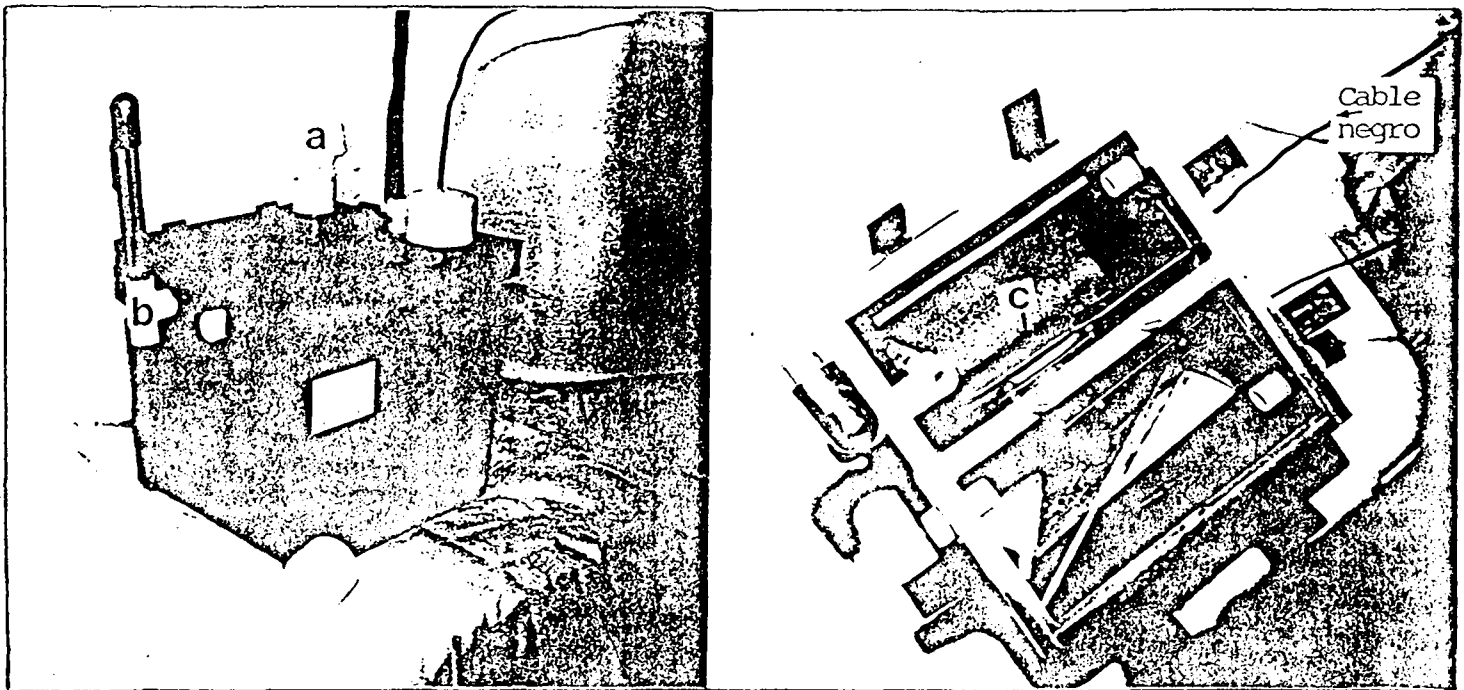


Vista exterior - con  
la tapa grande removida

Vista interior

II. El costado catódico produce gas de hidrógeno y cáustico (hidróxido de sodio), que son los derivados del proceso. Puede reconocerse por la tapa pequeña y el cable negro conectado a la misma.

- a. El agua penetra por el agujero cubierto por la tapa pequeña.
- b. Conector blanco en forma de T para la abertura de hidrógeno y el exceso cáustico del cátodo.
  - la parte inferior del conector permite que salga la solución de agua/hidróxido de sodio
  - la parte superior del conector permite que escapen los gases de hidrógeno.
- c. Cátodo: la lámina de metal (acero inoxidable con agujeros) atrae al sodio y al hidrógeno de la solución de sal.



Vista exterior -  
tapa pequeña removida

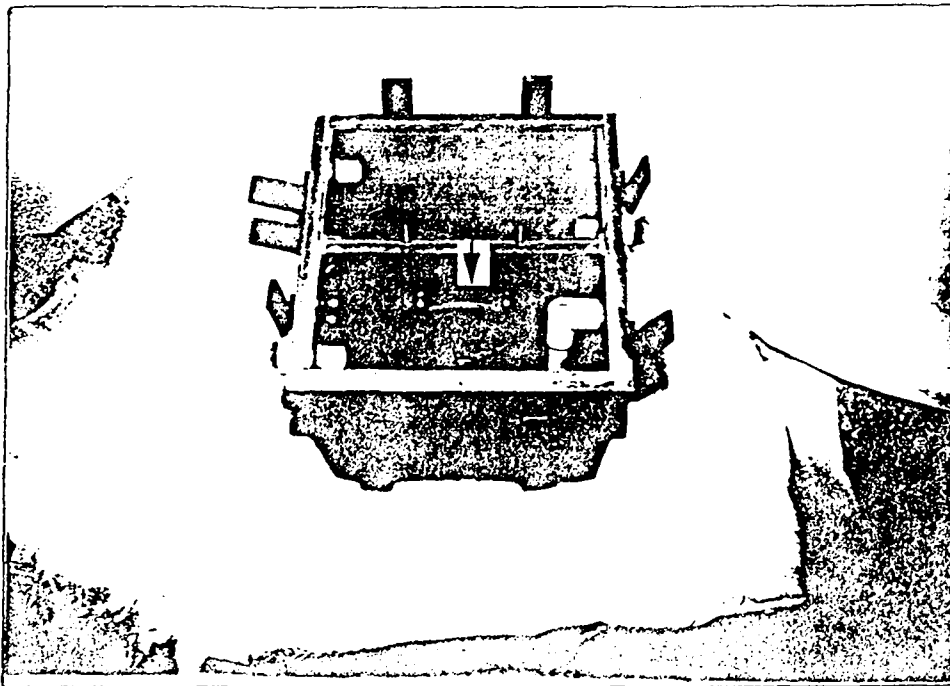
Vista superior sin  
la cubierta

### III. La membrana\*

La membrana es una de las partes más importantes del generador de desinfectante. La misma separa a los compartimientos del ánodo y del cátodo.

El proceso funciona de la manera siguiente:

- a. El sodio (de la sal) y el hidrógeno (del agua) pasan por el costado catódico (-).
- b. El gas de hidrógeno se produce en la celdilla del cátodo. Considerando que el mismo es más liviano que el aire, escapa hacia arriba. Se instala un tubo de escape para expulsarlo hacia afuera.
- c. El cloro no puede pasar a través de la membrana y permanece en la celdilla del ánodo (+). Esta mezcla de cloro y oxígeno en forma de gas es dirigida al sistema de abastecimiento de agua, para su desinfección.



\* La membrana es muy delicada y jamás debería tocarse a menos que se limpie con un chorro de agua.

## SEGURIDAD

Mantenga esta información sobre la seguridad en mente cuando trabaje con la unidad.

1. Instale la unidad de MOGGOD en un lugar bien ventilado.
2. Evite respirar las emanaciones provenientes de la unidad.
3. No ponga sus manos en el líquido que se encuentra en cualquiera de los compartimientos del generador de desinfectante. Si algún objeto se cayese dentro de un compartimiento de la unidad, trate de rescatarlo con una varilla o una manguera de plástico.
4. **ATENCIÓN:** Evite que el líquido de la unidad entre en contacto con sus ojos o su piel.
5. Evite que el líquido de la unidad entre en contacto con su ropa -- producirá manchas o agujeros.
6. **NUNCA** permita a sus niños jugar cerca de la unidad. Mantenga a los niños lejos de la unidad cuando limpie la misma.

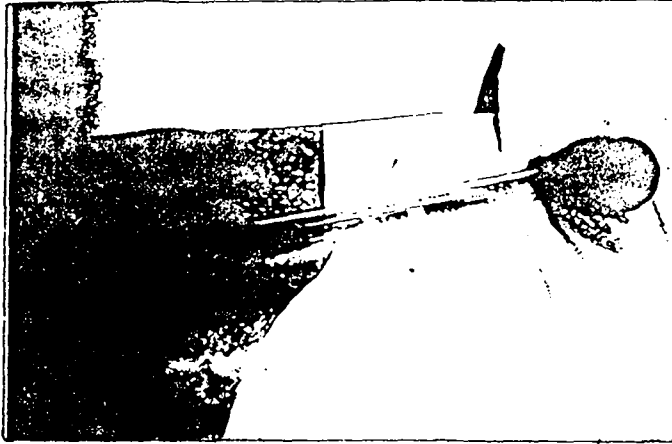
Si usted sufre un accidente, siga los procedimientos que se especifican más abajo.

SI	ENTONCES
Su piel entra en contacto con el líquido del costado del cátodo	Lave <b>INMEDIATAMENTE</b> el área con agua.
Cualquier líquido de la unidad entra en contacto con sus ojos	Lave los ojos inmediatamente con mucha agua.

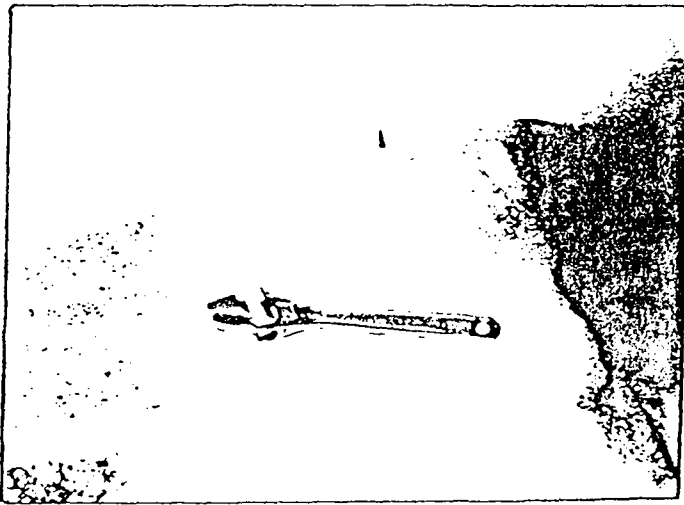
## MATERIALES NECESARIOS

Los siguientes artículos deben estar disponibles para poder llevar a cabo el mantenimiento.

- [ ] 1. Hidrómetro

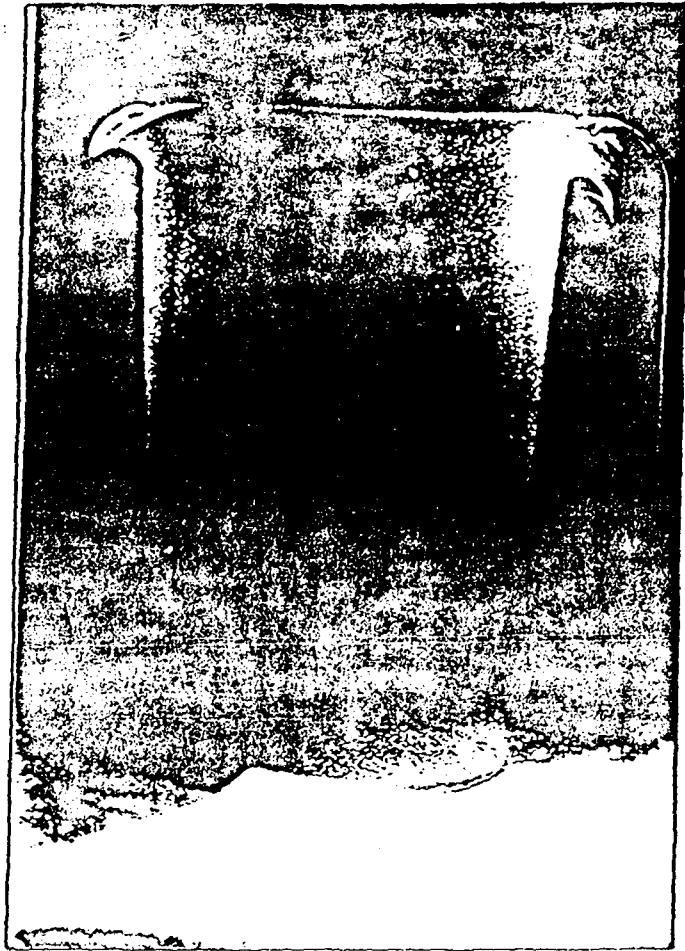


- [ ] 2. Manguera (para lavar y limpiar) conectada a un suministro de agua.
- [ ] 3. Tubo de 3/8 de pulgada para trasegar con sifón (tres pies de largo, o un metro).
- [ ] 4. Llaves de tuerca que son parte del equipo.





- [ ] 5. Tasa de medir, botella, o balde.



- [ ] 6. Balde de plástico para el líquido del cátodo.
- [ ] 7. Sal. (Utilice sal pura. Esto reducirá al mínimo los problemas de operación y mantenimiento, y vale el aumento del costo. No use sal de mar.) La comunidad deberá tener disponible una provisión de sal para un año --aproximadamente 15 bolsas de 50 libras cada una.

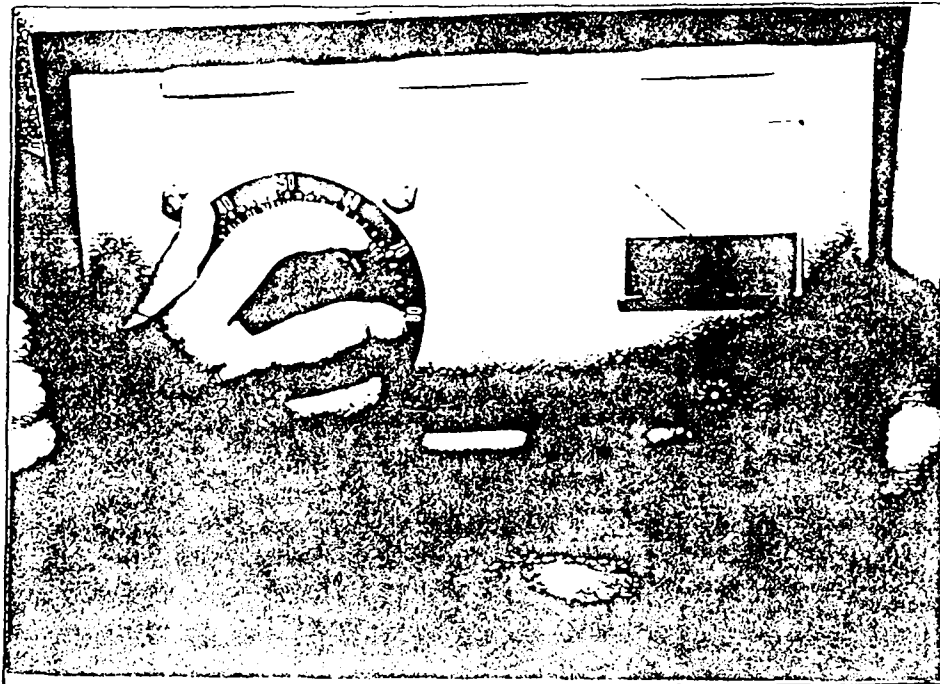
## LISTA DE VERIFICACION PARA OPERACIONES Y MANTENIMIENTO

Utilice esta lista de verificación para recordarle las tareas que usted debe llevar a cabo en forma regular.

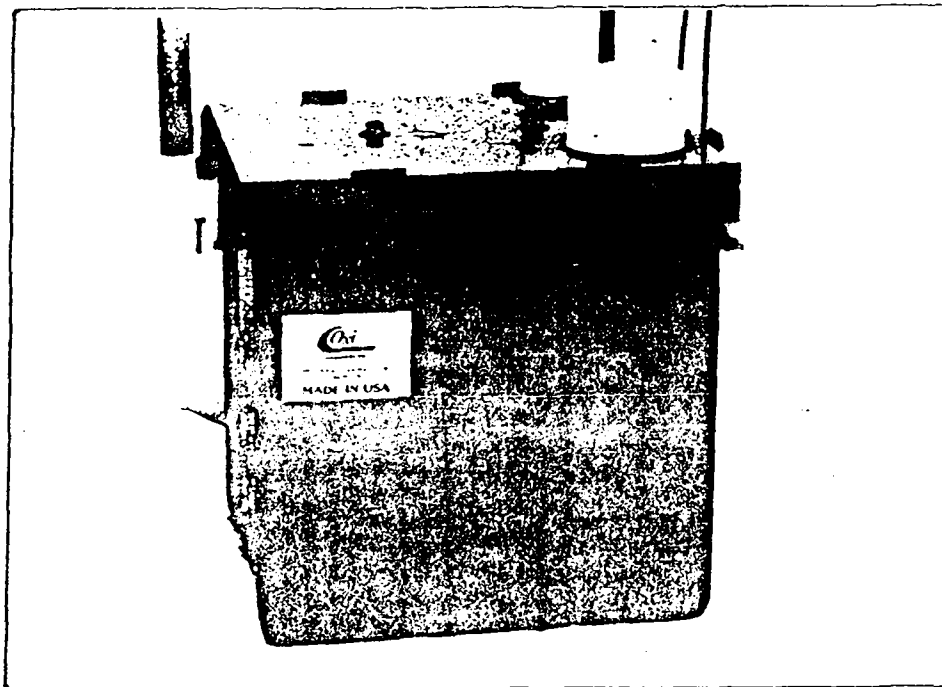
### Diariamente:

- [ ] Examine el medidor de amperios todos los días. Compare la posición de la aguja con la línea roja indicada en su regulador de potencia. (Esto indica el nivel de amperios necesario para mantener el nivel de desinfectante que se desea.) Ajústelo como sea necesario. (Vea los procedimientos de prueba de ajustes en la página del Manual de Instalación y Puesta en Funcionamiento.)

Es posible que usted tenga que ajustar los amperios si se desarrollan cambios en la calidad del agua sin elaborar (tales como una inundación).



- [ ] Examine la ventanilla de observación y asegúrese de que el nivel de sal alcanza la línea indicada. Agregue sal cuando sea necesario.
  
- [ ] Examine la ventanilla de observación y asegúrese de que el nivel de agua en el costado anódico se mantiene entre las marcas indicadas. Agregue agua cuando sea necesario. Evite sobrellenar.



- [ ] Agregue agua al costado catódico, utilizando la tasa de medir proporcionada.



Semanalmente:

- [ ] Evalúe la densidad del líquido del compartimiento del cátodo con el hidrómetro. (Véanse las instrucciones en la página 13.)
- [ ] Complete las verificaciones residuales de los desinfectantes en el sistema hídrico, una vez por semana. (Véanse las instrucciones correspondientes al equipo para la evaluación del cloro.)

Mensualmente:

- [ ] Complete la limpieza mensual. Véanse las instrucciones en la página 15.

## VERIFICACION POR MEDIO DEL HIDROMETRO

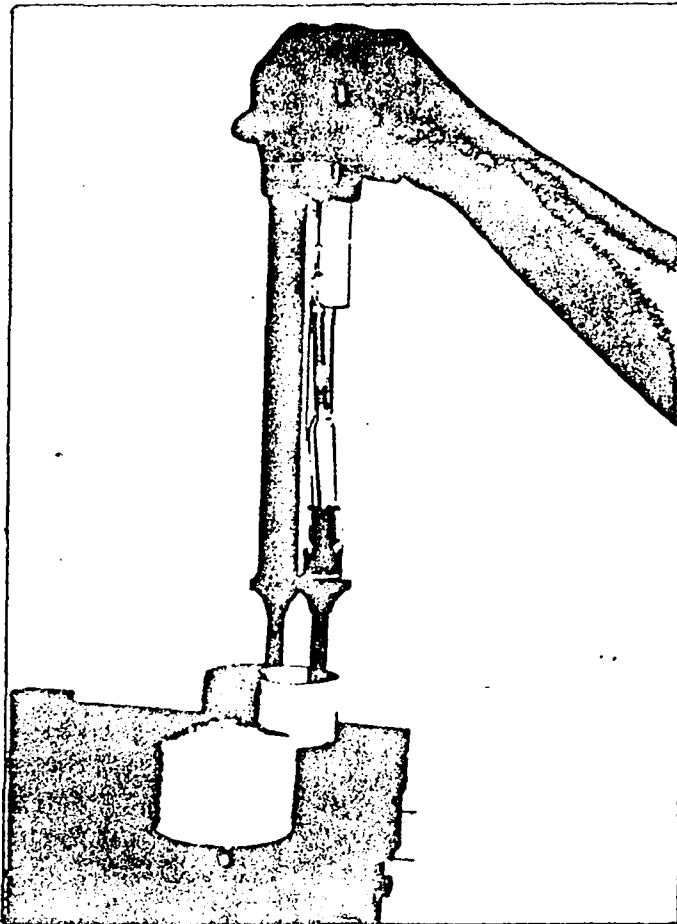
Usted llevará a cabo la verificación por medio del hidrómetro una vez por semana, para determinar que el líquido (hidróxido de sodio) en el costado catódico posee la densidad apropiada (concentración), para el funcionamiento eficaz de la unidad.

El hidrómetro es igual al utilizado para verificar la batería de un automóvil.

Si usted no dispone de un hidrómetro, siga los pasos indicados en la página siguiente.

### Verificación por medio del hidrómetro

1. Remueva la tapa negra del costado catódico.
2. Introduzca el hidrómetro hasta el fondo del compartimiento del cátodo y apriete la perilla y suéltela hasta que el líquido llene el hidrómetro. La parte flotante dentro del hidrómetro está diferenciada por una zona verde, una blanca y una roja.

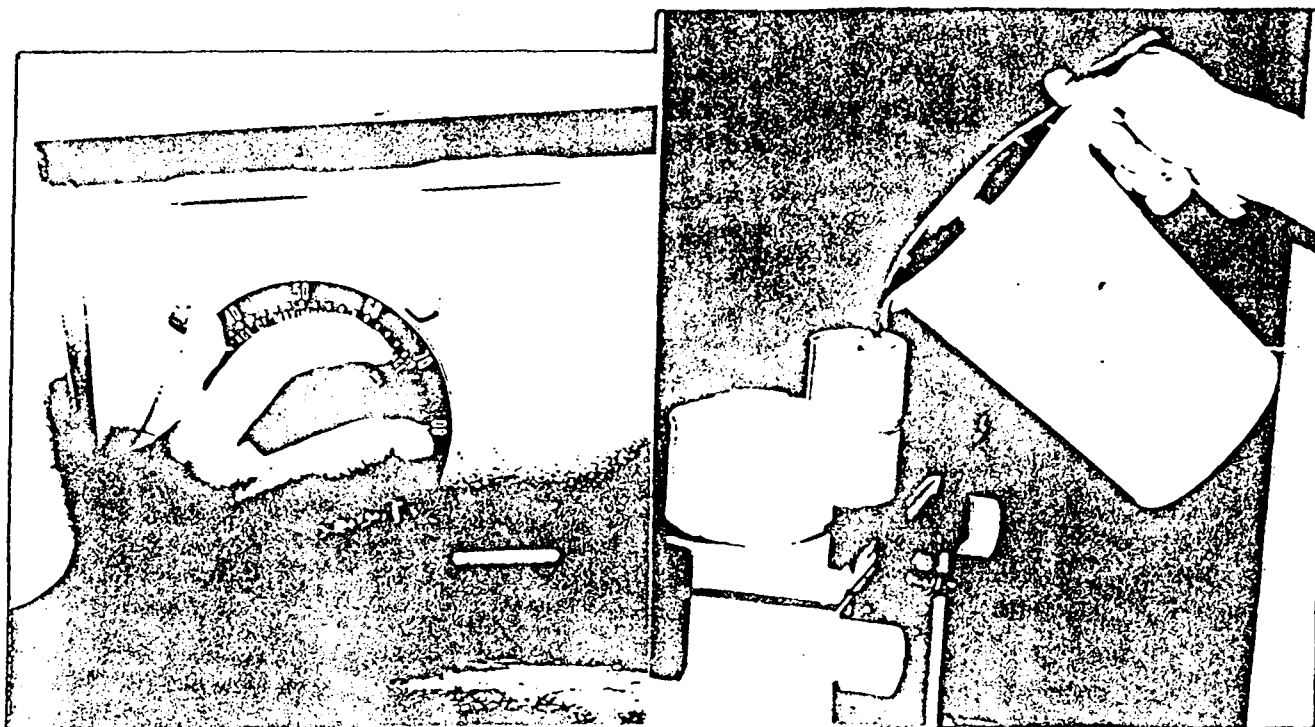


3. El nivel del agua debería permanecer a 1/4 de pulgada por encima o sobre la sección roja del medidor flotante.

SI	ENTONCES
<p>El nivel del agua está por debajo de la zona roja, el líquido es demasiado fuerte o debe diluirse</p>	<p>Agregar un litro de agua de lluvia o agua destilada y examinar nuevamente. Repita este procedimiento, si es necesario, hasta que el nivel del agua esté por encima del tope de la zona roja.</p>
<p>El nivel del agua se encuentra a 1/4 de pulgada por encima de la zona roja</p>	<p>Examínelo nuevamente en uno o dos días y agregue agua cuando sea necesario.</p>
<p>El nivel del agua se mantiene siempre por encima de la zona roja</p>	<p>Disminuya la cantidad de agua de lluvia que agrega diariamente al compartimiento del cátodo.</p>

Si no se dispone de un hidrómetro

Si usted no dispone de un hidrómetro, ajuste el regulador de potencia para que indique cinco amperios, y agregue agua dentro del costado catódico hasta que el indicador baje a cuatro amperios, y después pare. (Este procedimiento deberá tomar entre tres y cinco minutos.)

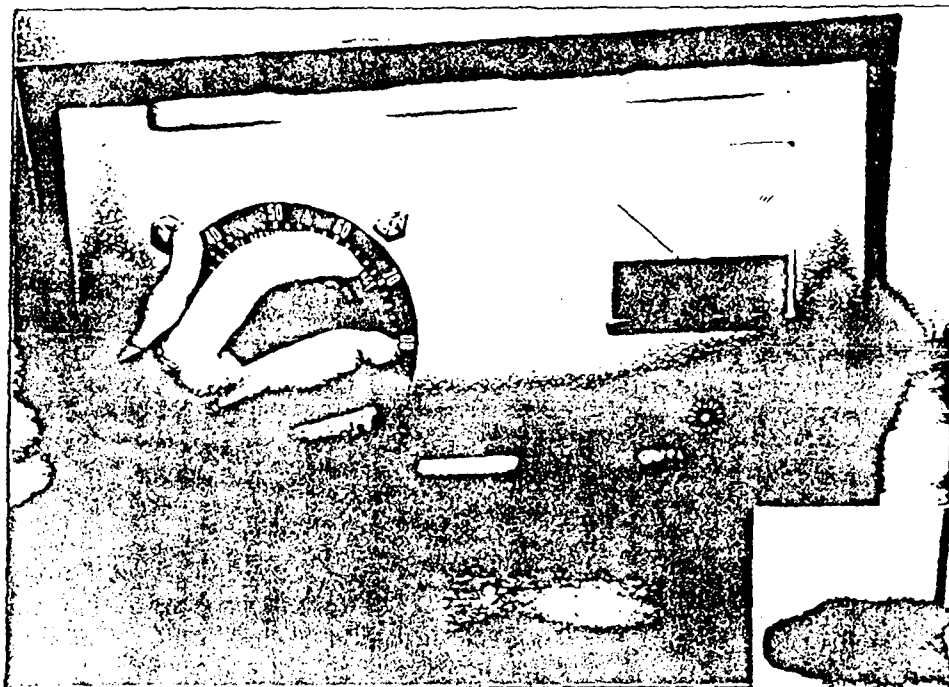


## LIMPIEZA MENSUAL

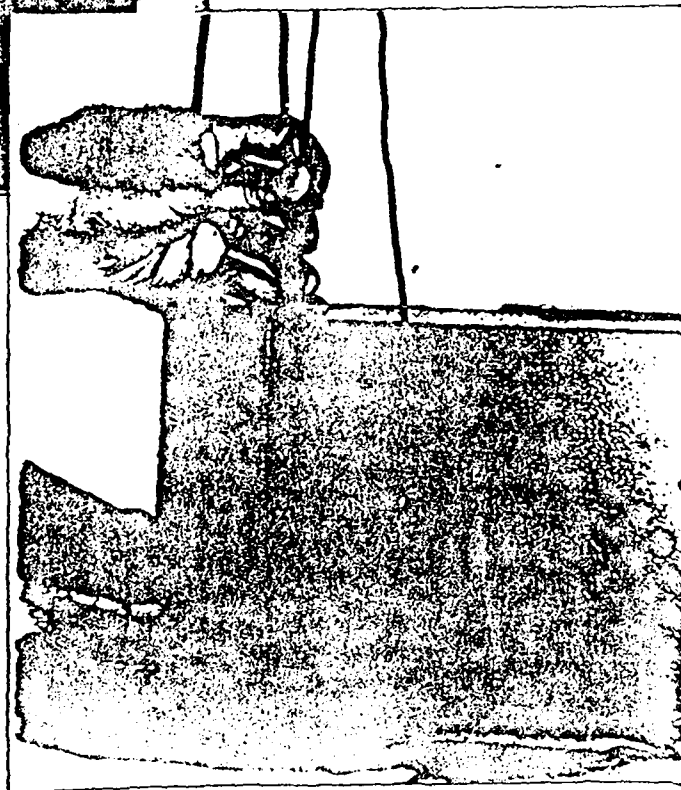
Usted debe tener mucho cuidado cuando limpie el MOGGOD. Evite respirar las emanaciones. Evite que su piel o ropa entren en contacto con el líquido de los costados del cátodo o del ánodo. Repase los procedimientos de seguridad que aparecen en la página 7, antes de llevar a cabo la limpieza.

PRIMERO, interrumpa la electricidad:

1. Apague la unidad.
  - a. Haga girar al dial hasta que el indicador muestre debajo del cero.

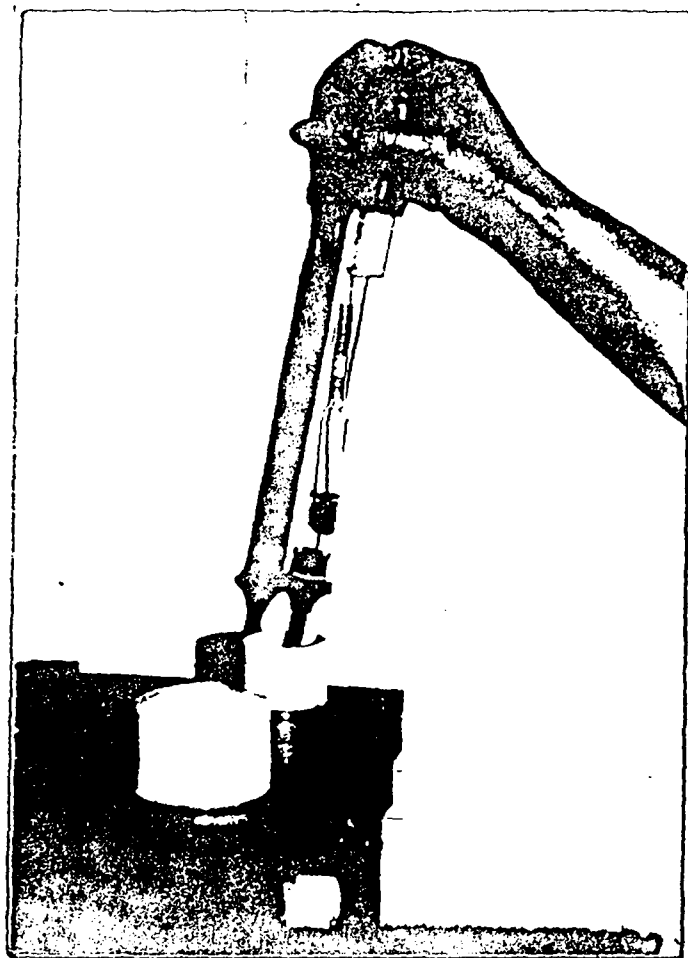
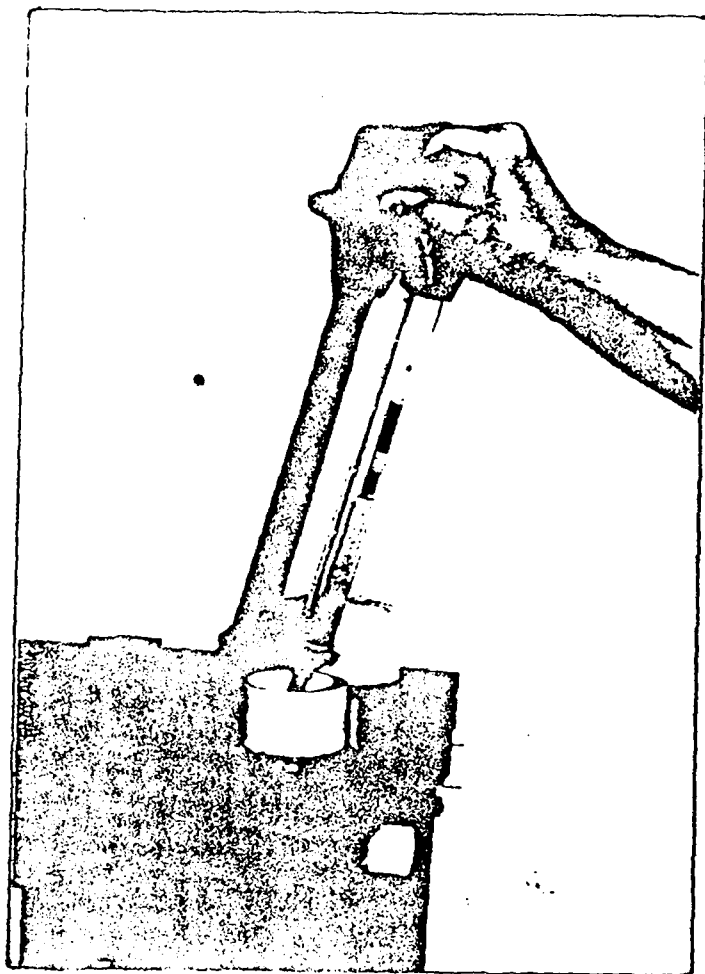


- b. *Desconecte la electricidad (desenchúfelo)*
    - c. *Desconecte los cables rojo y negro de la unidad de potencia.*



Luego, neutralice el gas:

2. Llene el hidrómetro hasta la mitad con el líquido (hidróxido de sodio) del costado catódico, introduciéndolo en el costado catódico a través de la tapa negra pequeña.

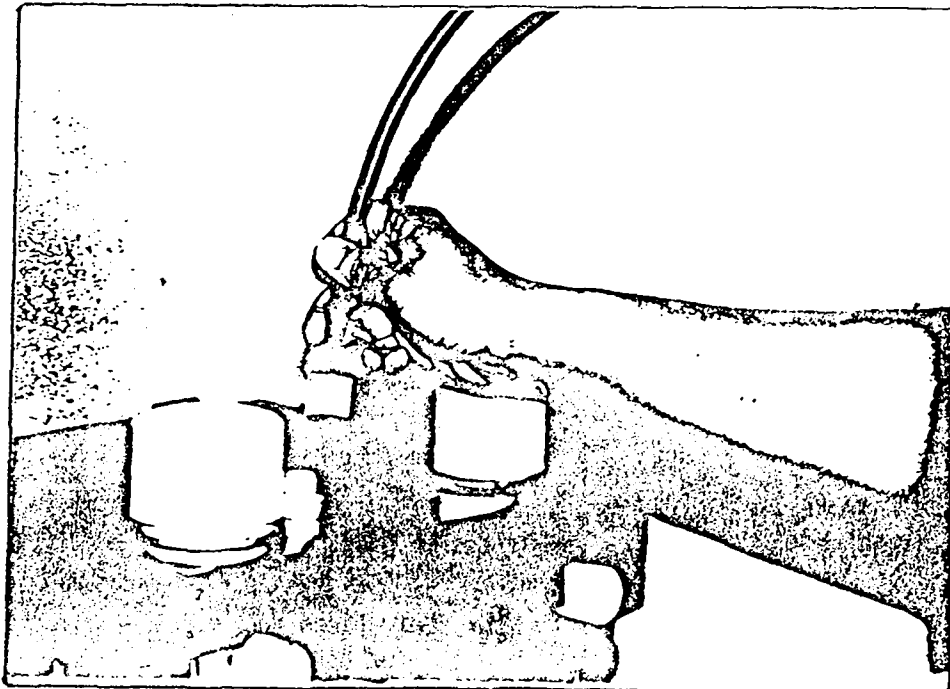
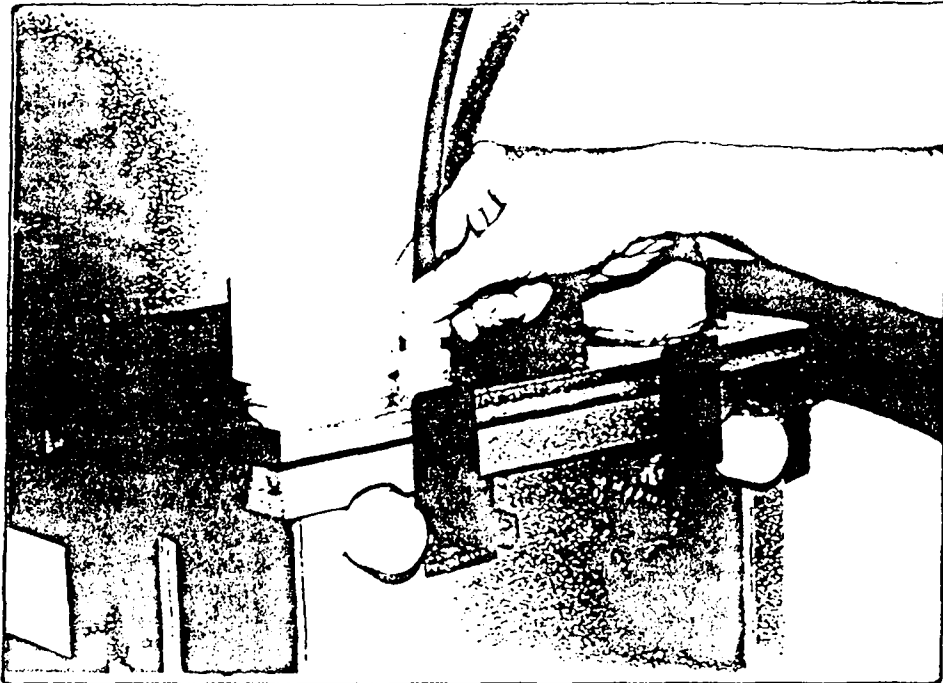


3. Agregue el líquido del punto 2 al costado del ánodo, colocando el hidrómetro a través del agujero de la tapa roja.

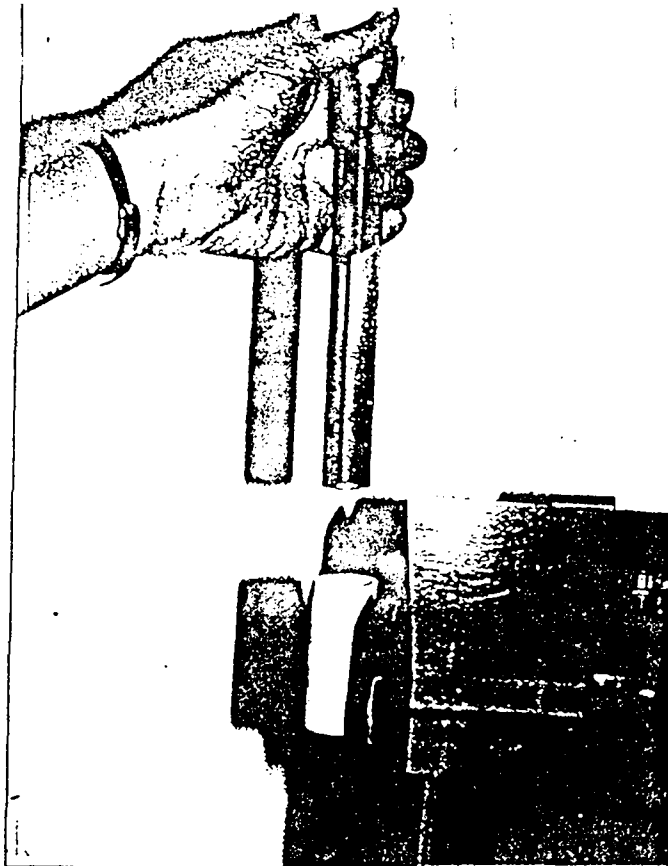


Luego, desconecte todos los tubos y los caños:

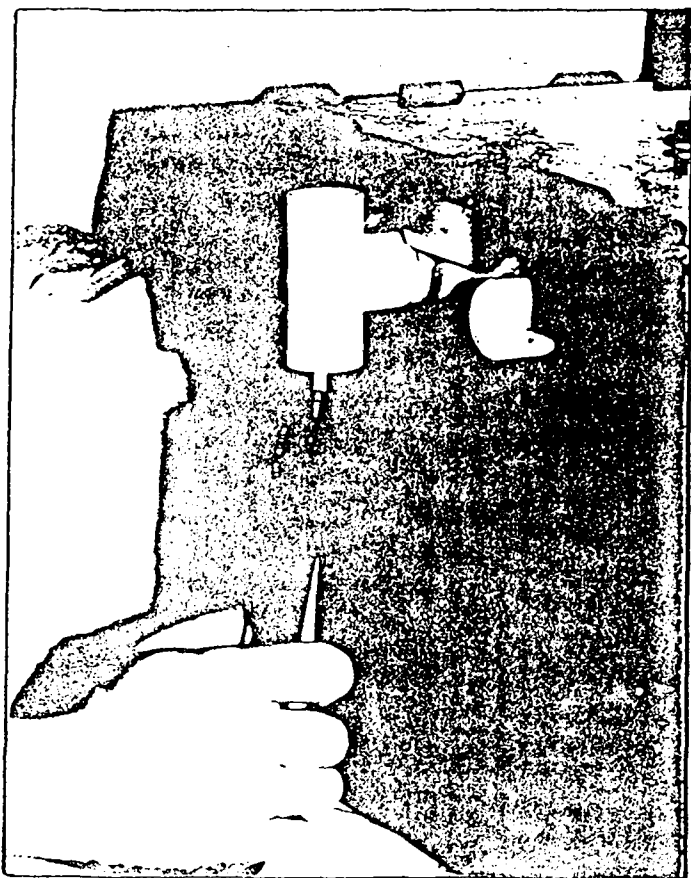
4. Desconecte la línea del gas (tubo flexible de 3/8 de pulgada).



5. Desconecte el tubo de ventilación de hidrógeno (CPV de 3/4 de pulgada) de la parte superior del conector blanco en forma de T.

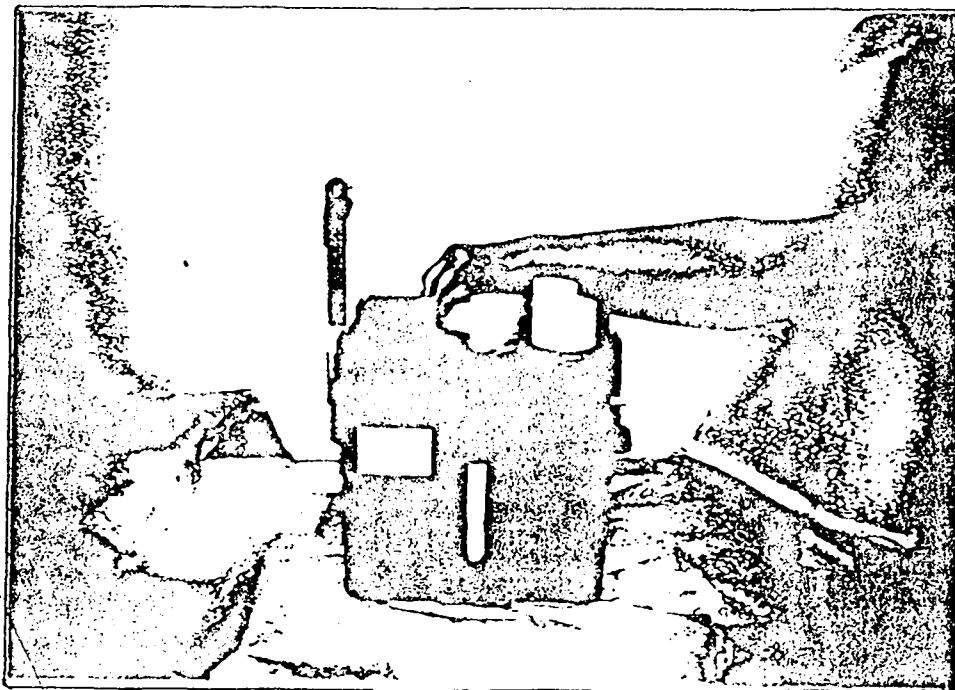
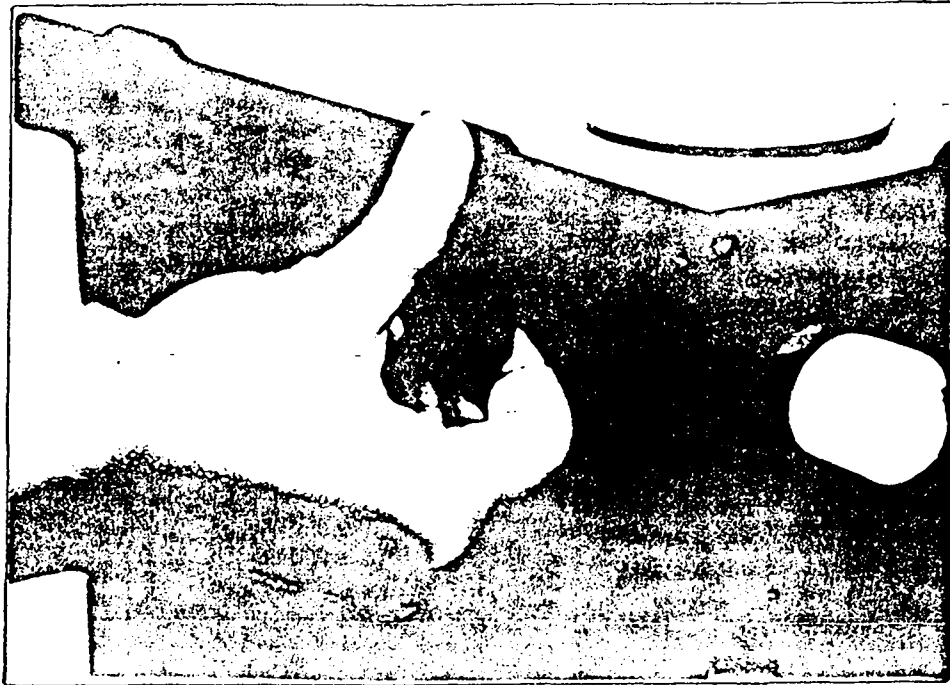


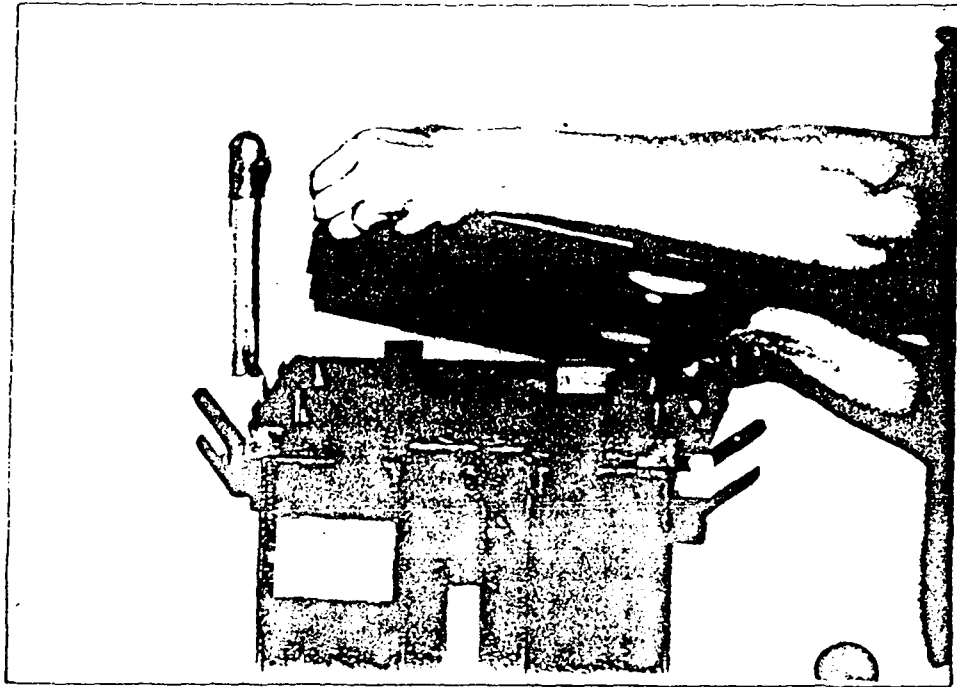
6. Desconecte los tubos de descarga del hidróxido de sodio de la parte inferior del conector blanco en forma de T.



Vacíe ambos compartimientos:

7. Abra las abrazaderas y remueva las tuercas de oreja y las arandelas. Remueva la tapa del generador de desinfectante. Coloque las arandelas y las tuercas de oreja en un lugar seguro.





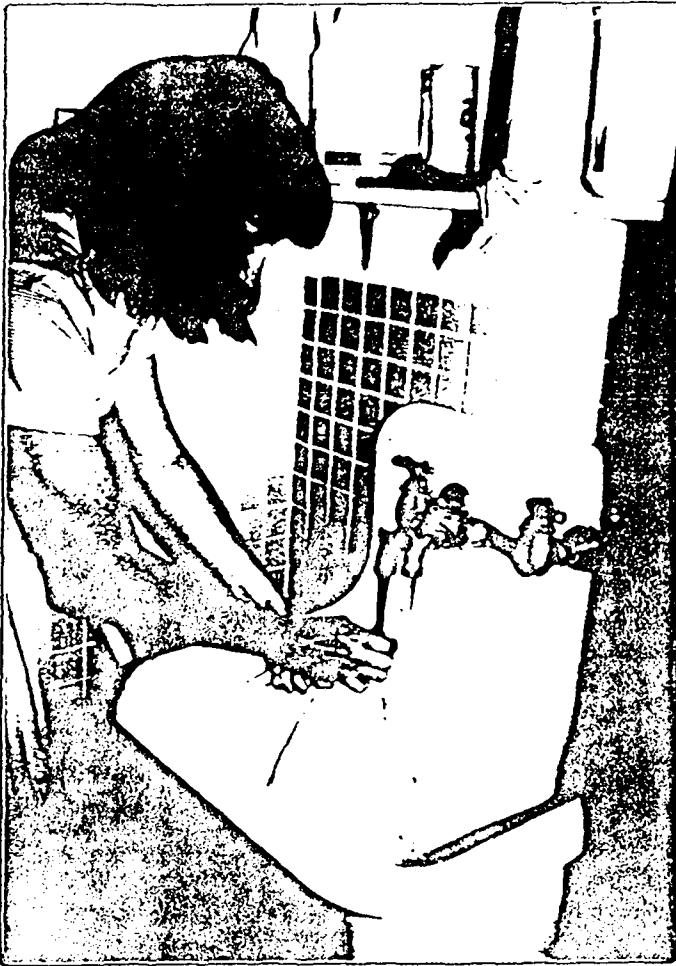
8. Ahora es necesario remover todo el líquido del MOGGOD.

PRIMERO saque con sifón el líquido del costado anódico (tapa roja).

Atención: es posible que se emitan gases durante el procedimiento de trasegado con sifón. JAMAS intente sacar con sifón utilizando su boca.

Como trasegar con sifón:

- a. Llene el tubo de sifón con agua. No deberá haber burbujas.



- b. Coloque sus pulgares sobre cada extremo del tubo, y aguante el agua en su lugar.

- c. Coloque un extremo del tubo dentro del fondo del costado anódico de la unidad, y mantenga el otro extremo cerrado con su dedo. Coloque un extremo a un nivel más bajo que el MOGGOD para vaciar los contenidos en un balde o botella de plástico.



- d. Retire su dedo del extremo de desagüe para poder drenar el líquido del compartimiento del ánodo.

- e. Una vez completado el desagüe, eleve el extremo del tubo correspondiente al ánodo para escurrir el líquido restante. Enjuague el tubo con agua.



9. Luego remueva con sifón el líquido del compartimiento del cátodo y colóquelo en un receptáculo de plástico separado. Siga las indicaciones que se especifican en el paso 8, supra. Guarde dos litros de este líquido (hidróxido de sodio) para utilizarlos más tarde en la puesta en funcionamiento de la unidad. (Puesta en funcionamiento, paso 3b.)

10. Cuando ambos compartimientos están vacíos, recoja la unidad y llévela al lugar de limpieza. Enjuague **AMBOS** compartimientos con agua para remover los sedimentos e impurezas que podrían haberse acumulado en los compartimientos.

11. Lave la membrana con agua.

**EVITE TOCAR LA MEMBRANA!** No intente limpiarle con un cepillo o cualquier otro objeto. Solamente enjuáguela con agua. **LA MEMBRANA ES MUY FRAGIL.**

\* Si la calidad de la sal que se utiliza es muy baja, o si se utiliza un chorro de agua fuerte, la membrana eventualmente acumulará calcio y magnesio. Esta acumulación aparecerá en forma de una capa pesada de color blanco/gris. Entonces, será necesario:

- a. empaparla en vinagre introduciendo vinagre en el costado del ánodo del generador
- b. enjuagarla entonces con agua.

No habrá necesidad de remover la membrana del generador para su limpieza.

12. El resto de los líquidos que usted ha vaciado de los compartimientos del ánodo y del cátodo pueden descargarse en la alcantarilla. Si no existiese dicha alcantarilla, los mismos podrán descargarse en un hoyo pequeño en la superficie. (El hidróxido de sodio proveniente del costado catódico puede utilizarse como un limpiador de plomerías. Ver página 42 para otros usos.)

13. Ponga en funcionamiento el MOGGOD siguiendo las instrucciones de la página 25.



## PUESTA EN FUNCIONAMIENTO

1. No enchufe el cable a la unidad de potencia hasta que llegue al paso 10.
2. Prepare una solución de agua salada saturada en un balde o una botella: empape las piedrillas de sal con agua de lluvia o agua destilada hasta que no puedan disolverse más. Coloque el agua a un lado. No utilice el agua hasta llegar al paso 4.
3. Prepare el compartimiento del cátodo:
  - a. Llene el costado del cátodo con agua de lluvia (o agua destilada).

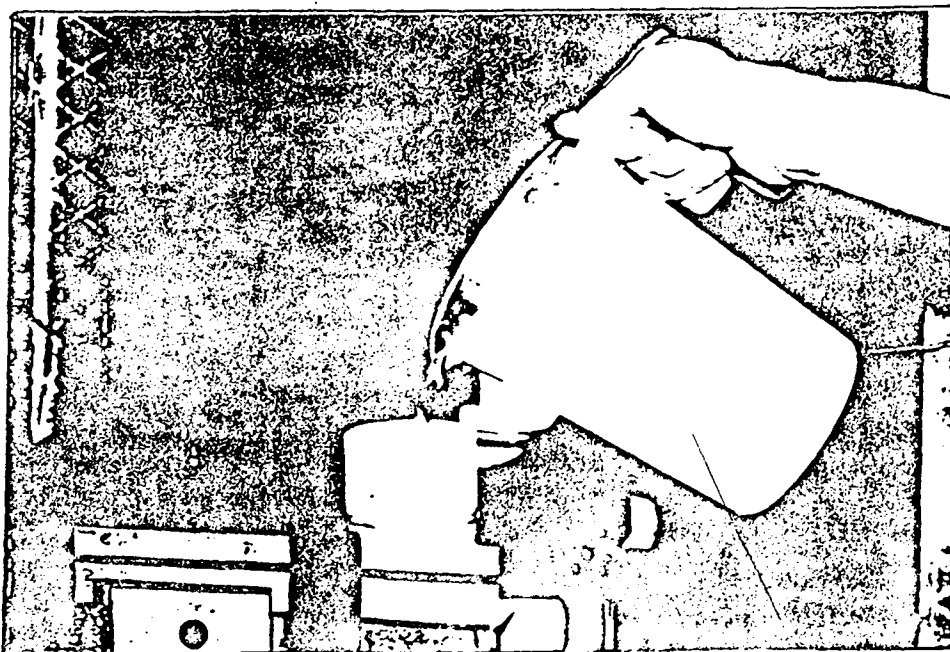


- b. Agregue todo el hidróxido de sodio (cáustico) que usted guardó durante el proceso de limpieza del costado catódico.

(introduzca fotografía)

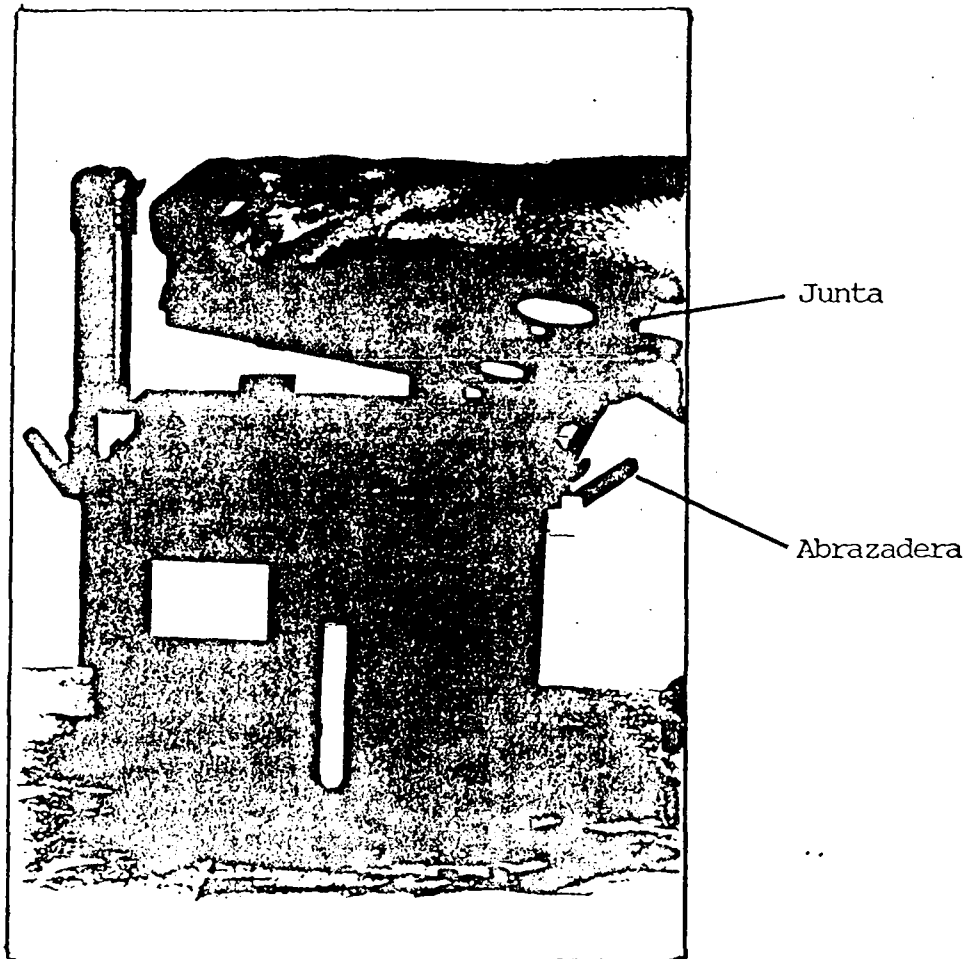
4. Prepare el compartimiento del ánodo:

- a. Llene el compartimiento del ánodo (tapa roja) con sal, hasta el nivel indicado en la ventanilla de observación.
- b. Agregue agua salada saturada lentamente hasta el nivel de las tuercas superiores de la ventanilla de observación. Cuando el agua comienza a gotear por las aberturas de rebose en el costado del generador de desinfectante, significa que usted ha agregado suficiente agua.



Arme nuevamente la unidad y conecte las tuberías

5. Asegúrese de que las juntas que corren por debajo de la tapa no tienen tierra o sal. Coloque la tapa en la unidad. Examine las abrazaderas exteriores para asegurarse de que no haya acumulación de sal, y límpielas cuando sea necesario.

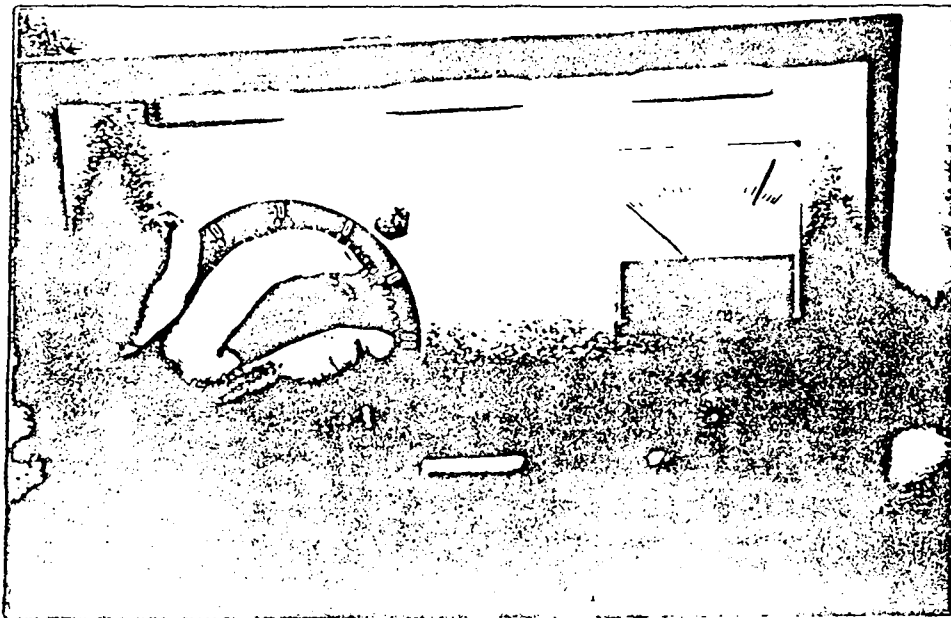


6. Conecte nuevamente la línea de gas (tubo flexible de 3/8 de pulgada).

7. Conecte nuevamente el tubo de ventilación del hidrógeno a la parte superior del conector blanco en forma de T.
8. Conecte nuevamente el tubo de descarga a la parte inferior del conector blanco en forma de T.
9. Conecte nuevamente los cables rojo y negro a la unidad de potencia.
10. Conecte el regulador de potencia a la fuente de potencia, enchufándolo en una toma de electricidad.

(introduzca la fotografía del campo)

11. Coloque el dial del regulador de potencia en la marca indicadora roja.



## REPARACION DEL GENERADOR DE DESINFECTANTE

La unidad generadora de desinfectante MOGGOD es muy durable y sin desperfectos, y rara vez necesitará reparaciones. No obstante, es posible que haya instancias en las cuales el mantenimiento por sí solo no es suficiente para asegurar la operación correcta del sistema. Las secciones siguientes le proporcionarán ayuda para llevar a cabo las reparaciones básicas.

REPARACION DE DESPERFECTOS

<u>Sintomas</u>	<u>Medidas</u>
<p>Si el medidor de amperios en el regulador de potencia no indica ningún tipo de corriente</p>	<p>Primero, asegúrese de que no ha habido un corte de luz</p> <p>a. si hay electricidad, entonces examine el fusible en la parte frontal de la unidad de potencia, y reemplácelo si es necesario. (Ver las instrucciones que aparecen en la página 34.)</p> <p>b. si el medidor aún no registra corriente, asegúrese de que la unidad de bombeo está funcionando y examine el fusible o los interruptores de circuito en el suministro de potencia principal.</p>
<p>Si hay un fuerte olor a gas de cloro en la habitación o recinto protector.</p>	<p>Diríjase a la gráfica que aparece en la página 32, para procedimiento de reparación de desperfectos.</p>
<p>Si no hay residuos de cloro en el suministro de agua (después de haber pasado por el tubo de Venturi).</p>	<p>a. asegúrese de que no ha habido un corte de luz siguiendo los procedimientos indicados más arriba.</p> <p>b. en caso de no haber sufrido un corte de luz, diríjase a la gráfica que aparece en la página 32, para procedimientos de reparación de desperfectos.</p>

Síntomas

Si usted tiene un flujo continuo pero o un residuo de cloro, cuando hace el examen del cloro.

Si el ánodo despide un olor dulce (en lugar de un olor fuerte de cloro).

Si la membrana está rota o perforada.

Medidas

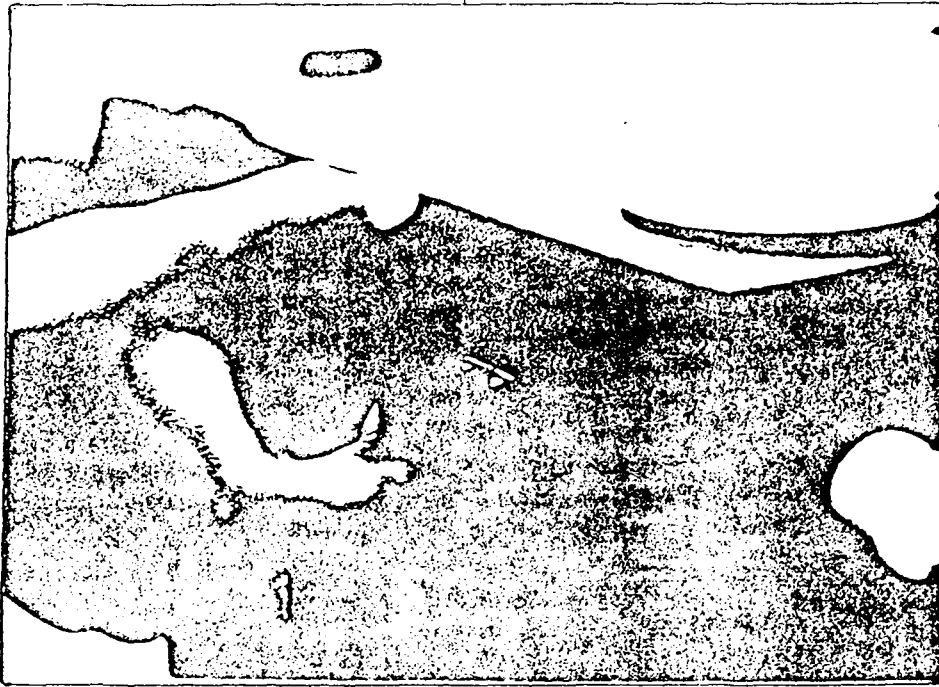
Cambie la membrana

Cambie la membrana

Cambie la membrana

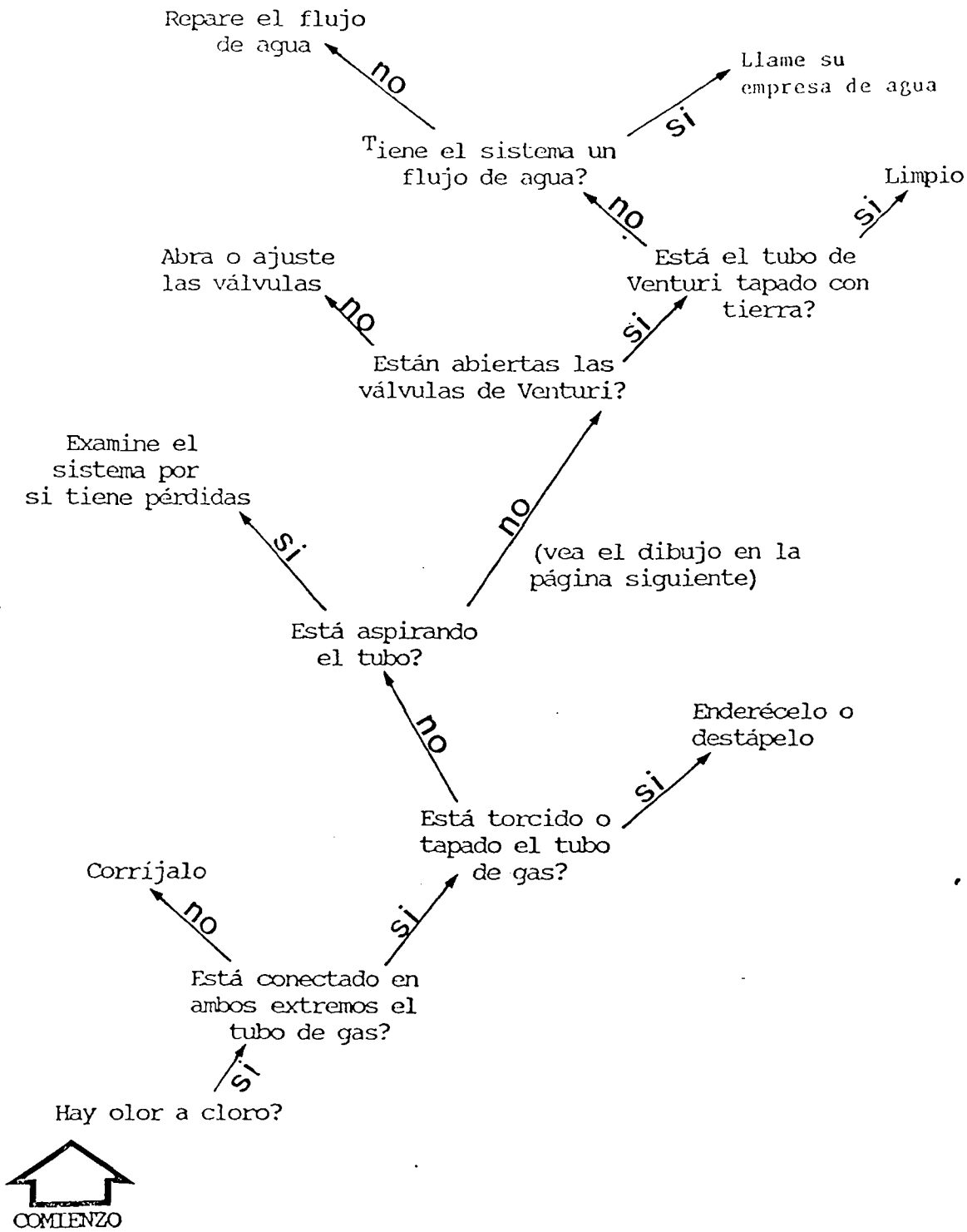
Las abrazaderas exteriores de la tapa del generador de desinfectante no permanecen cerradas.

Examínelas por acumulación de sal y límpielas.



### GRAFICA PARA LA REPARACION DE DESPERFECTOS

Si hubiese olor a cloro alrededor del sistema MOGGOD, podría haber varias explicaciones para ello. Utilice la gráfica que se indica más abajo para tratar de determinar la causa.





Si el Venturi no tiene aspiración, examine las conexiones siguientes:

1. No logrará aspiración en el tubo de Venturi si:
  - a. no hay flujo de agua en las tuberías principales,
  - b. las tuberías de gas están desconectadas en el Venturi o en el generador,
  - c. la válvula B está completamente abierta,
  - d. las válvulas C o D están cerradas,
  - e. el tubo de Venturi está tapado con tierra,
  - f. las tuberías de gas están tapadas o torcidas,
  - g. la bomba tiene una obstrucción de aire.

## COMO CAMBIAR EL FUSIBLE EN EL REGULADOR DE POTENCIA

### Cuándo se debe reemplazar el fusible

- a. Si el medidor de amperios en el regulador de potencia no indica ninguna corriente, apague el regulador de potencia.
- b. Examine el fusible en la parte frontal del regulador. Si el fusible estuviese quemado, reemplácelo. Usted podrá reconocer a un fusible quemado observando unos puntos ennegrecidos y el filamento roto.

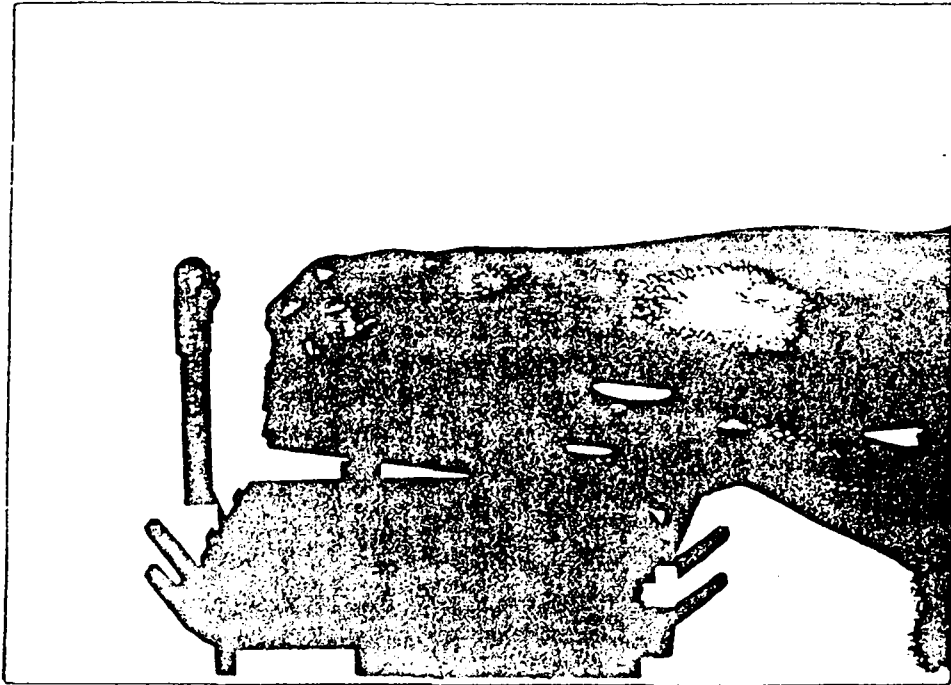
### Cómo reemplazar el fusible

1. De vuelta la perilla negra pequeña 1/4 de pulgada (en la parte frontal del regulador de potencia).
2. Remueva el fusible quemado y tirelo.



3. Introduzca el fusible nuevo en la perilla negra. La posición de los extremos es indiferente.
4. Empuje la perilla negra completamente dentro del receptáculo y enrósquela, con el fusible adentro, nuevamente al regulador de potencia.

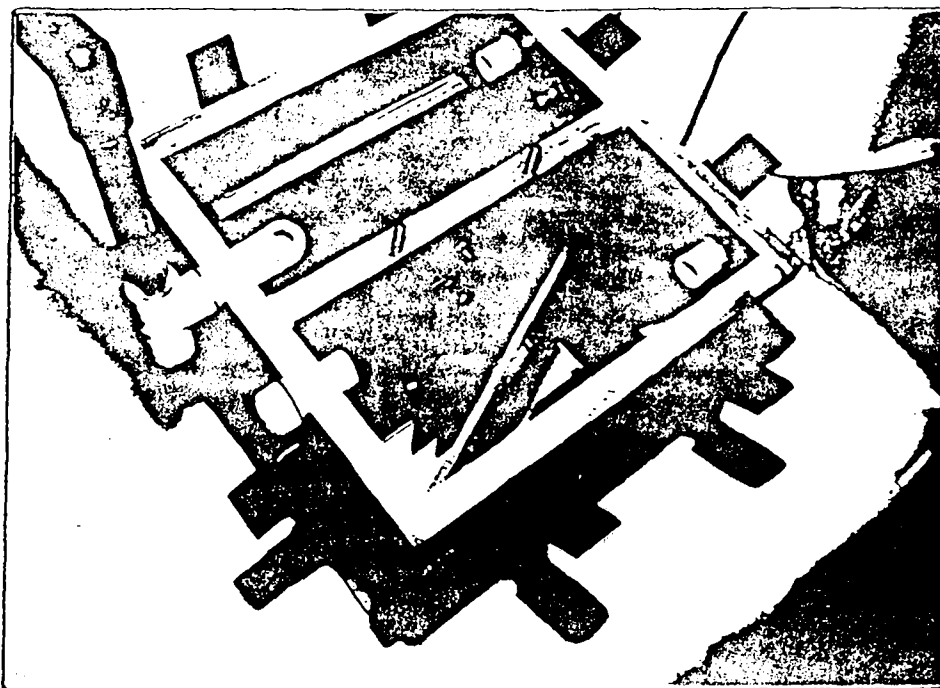
3. Remueva la membrana.
4. Coloque la membrana nueva. La parte de la junta blanca debe colocarse contra la pared separadora.
5. Ajuste las tuercas hasta que la punta de los pernos aparezcan en la superficie.
6. Llene la unidad con agua y sal, hidróxido de sodio, etc., siguiendo el procedimiento de puesta en funcionamiento.
7. Coloque la tapa en su lugar. Ajuste las abrazaderas y las tuercas de oreja.



8. Coloque los tubos flexibles de rebose en su lugar.

## REEMPLAZO DE LAS BARRAS ANODICAS Y CATODICAS

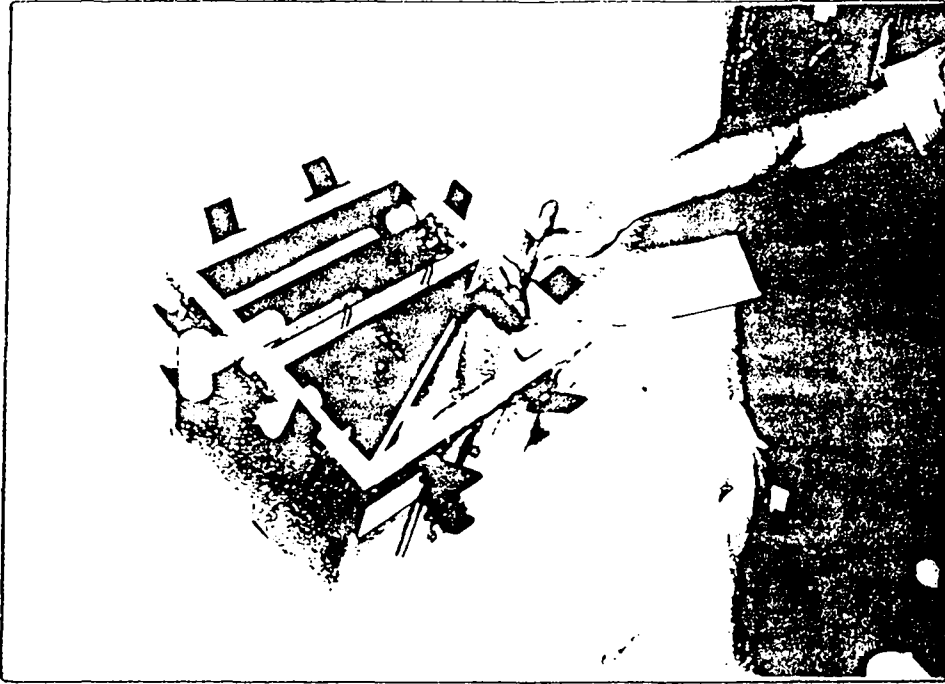
### Cuándo se debe reemplazar la barra anódica



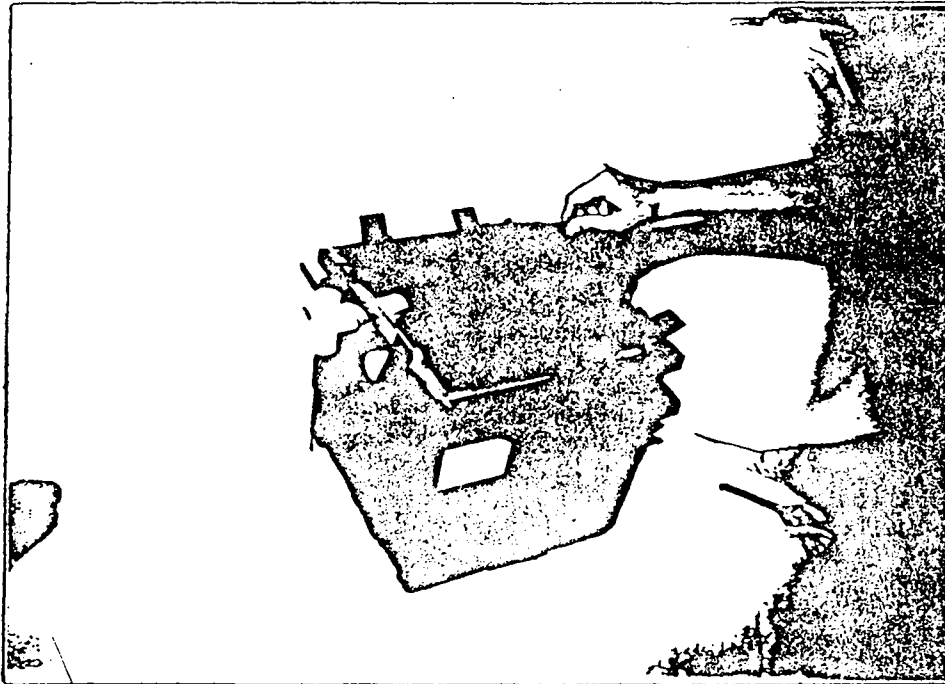
Es muy raro que se tenga que reemplazar el ánodo. Su tiempo de duración está estimado entre siete y diez años. Si es necesario reemplazarlo, refiérase a los pasos siguientes:

1. Remueva la tapa de la unidad y siga los mismos pasos utilizados para la limpieza mensual, pasos 1 a 12 (comenzando en la página 15).

2. Afloje la(s) tuerca(s) que conecta el ánodo a la pared de la unidad.  
(Evite remover las tuercas completamente, sólo debe aflojarlas.)



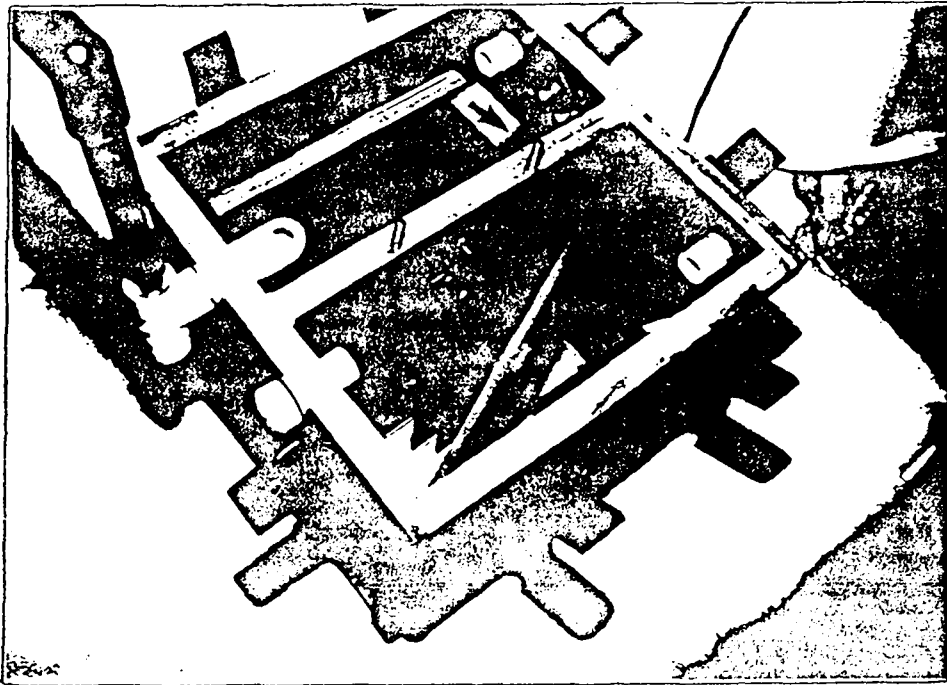
3. Deslice la barra anódica hacia arriba y hacia afuera del perno.



4. Deslice la nueva barra anódica hacia abajo y sobre el perno.
5. Ajuste las tuercas.

Cuándo se debe reemplazar la barra catódica

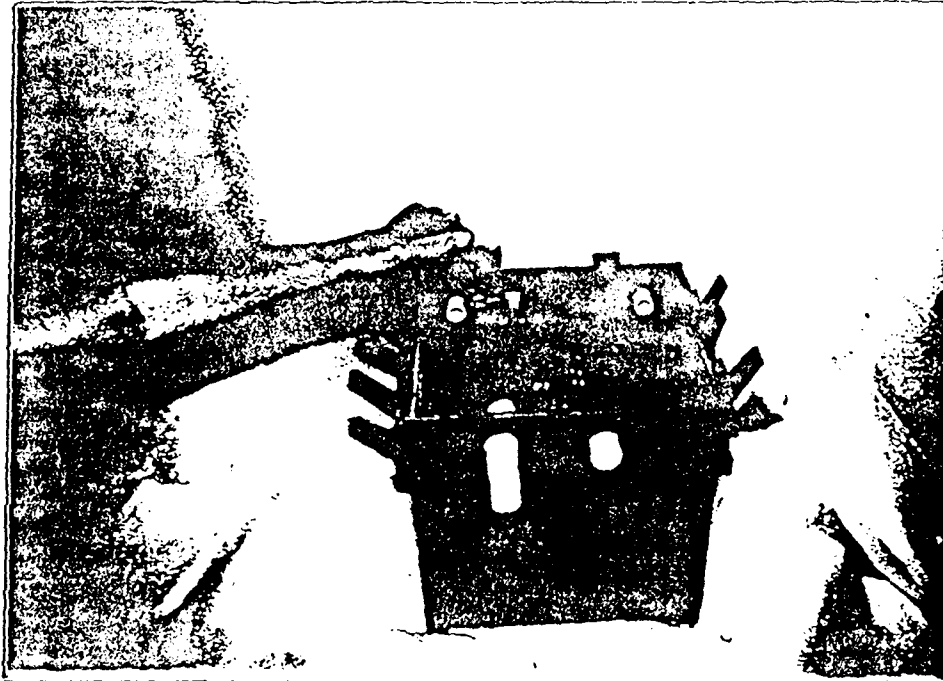
Si el cátodo se halla muy picado en la proximidad de la superficie del líquido.



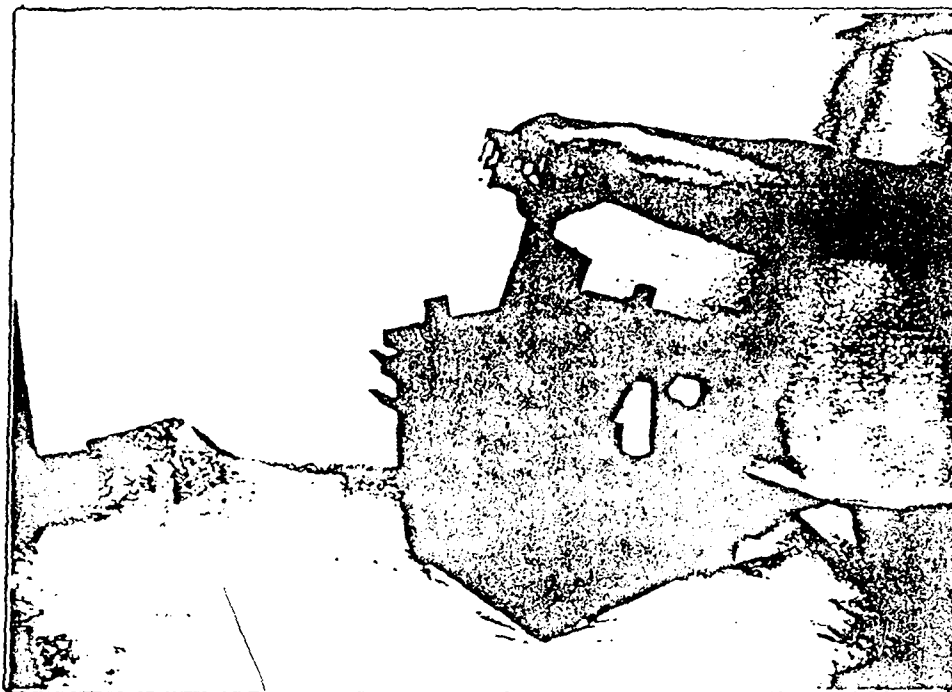
Reemplazo del cátodo:

1. Remueva la tapa de la unidad y siga los mismos pasos que se utilizaron para la limpieza mensual, pasos 1 a 12. (Comenzando con la página 15.)

2. Afloje la tuerca que conecta el cátodo a la pared de la unidad.  
(Evite sacar la tuerca completamente, sólo debe aflojarla.)



3. Deslice la plancha catódica hacia arriba y hacia afuera del perno.



4. Deslice la nueva plancha catódica hacia abajo y sobre el perno.
5. Ajuste el perno.

Posibles usos para el exceso de hidróxido de sodio

- El hidróxido de sodio puede descargarse en el suministro de agua. No causará daño al agua y ajustará el pH.
- El hidróxido de sodio puede guardarse y agregarse más tarde al suministro de agua.
- El hidróxido de sodio puede utilizarse para limpiar el sumidero o el inodoro.
- El hidróxido de sodio puede almacenarse en un recipiente no corrosivo y utilizarse para hacer jabón.



SECRETARIA DE SALUD  
SUBSECRETARIA DE REGULACION SANITARIA Y DESARROLLO  
DIRECCION GENERAL DE INVESTIGACION Y DESARROLLO TECNOLOGICO

CELDA ELECTROLITICA

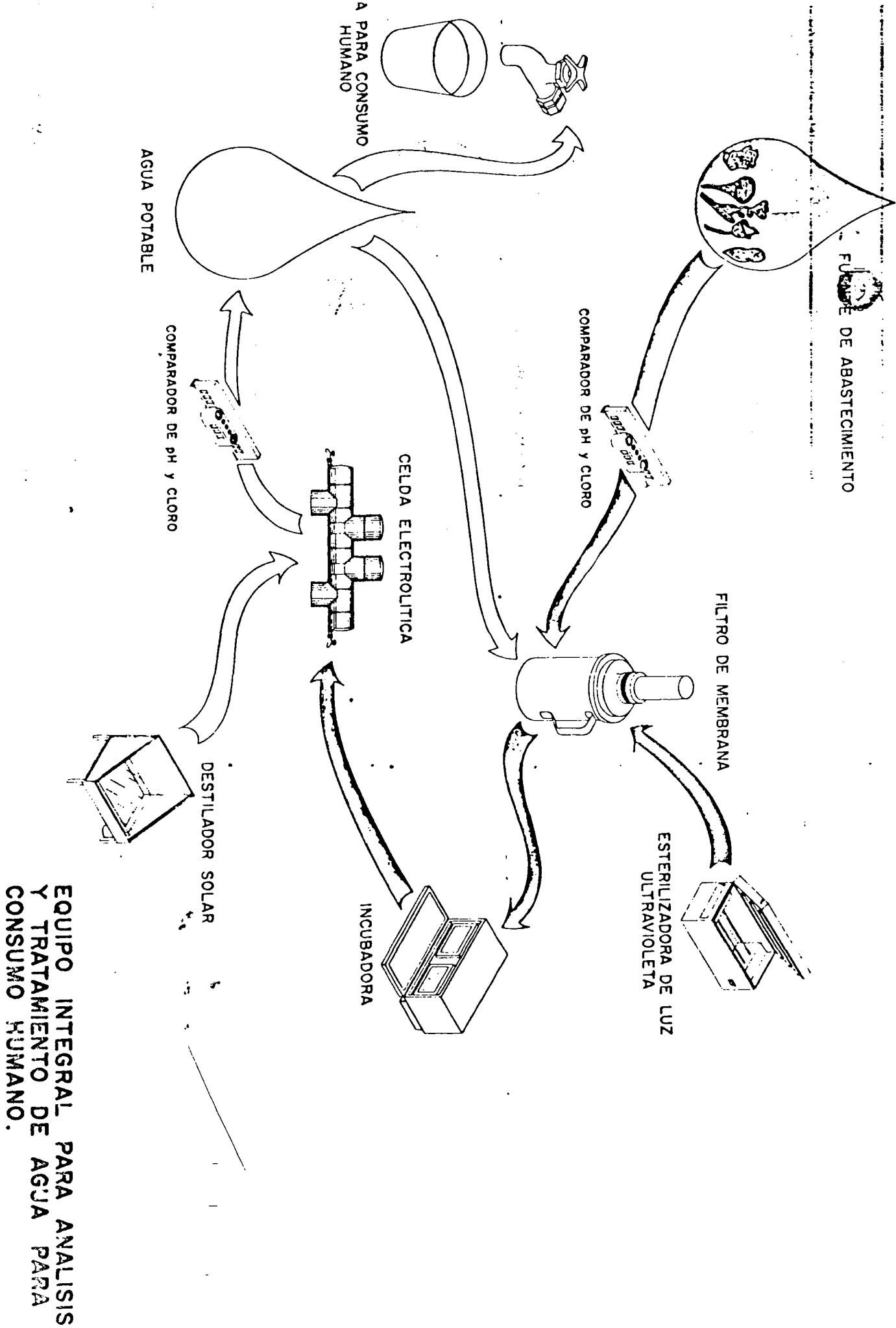
MANUAL DE OPERACION Y MANTENIMIENTO

C E D A T

1987.

# I N D I C E

INFORMACION GENERAL - - - - -	4
ESTRUCTURA DE LA CELDA ELECTROLITICA - - - - -	5
INSTRUCCIONES DE OPERACION	
MANTENIMIENTO DE LA CELDA ELECTROLITICA - - - - -	8
RECOMENDACIONES - - - - -	9
ACCESORIOS Y REACTIVOS - - - - -	11



EQUIPO INTEGRAL PARA ANALISIS Y TRATAMIENTO DE AGUA PARA CONSUMO HUMANO.

## INFORMACION GENERAL

Debido a la acción de corriente directa. la Celda Electrolítica ioniza soluciones de cloruro de sodio, produciendo cloro gaseoso. Al ser dosificado éste al agua para consumo humano, produce la desinfección y potabilización bacteriológica.

## PRINCIPIO DEL METODO

La Celda Electrolítica se basa en el proceso de electrolisis, está formada por dos compartimientos; uno de ellos contiene una solución de cloruro de sodio en agua y, el otro de hidróxido de sodio también en agua. Al pasar la corriente eléctrica a través de los electrodos y soluciones, y de acuerdo con la intensidad medida en amperes que proporcione una fuente de corriente eléctrica regulada, la celda producirá cloro mediante una reacción de electrolisis en el compartimiento del cloruro de sodio. El gas cloro será introducido a la tubería del agua mediante un inyector Venturi logrando con esto desinfectar el agua de consumo humano de poblaciones rurales hasta de 2000 habitantes. En el compartimiento de hidróxido de sodio se producirá hidrógeno que se desprenderá a la atmósfera.

## ESTRUCTURA DE LA CELDA ELECTROLITICA

(Ver Fig. 1)

- a) La celda (A) contiene una solución saturada de cloruro de sodio y un electrodo de grafito (2).
- b) La membrana de Nafion (3) es un polímero permeable a cationes (iones positivos) y compuestos polares.  
Es impermeable a aniones (iones negativos) y a compuestos no polares.
- c) La celda (B) contiene una solución de hidróxido de sodio y un electrodo de acero inoxidable.
- d) Los electrodos están conectados a una fuente reguladora de corriente directa; el electrodo de grafito está conectado al polo positivo (5) de la fuente y el de acero inoxidable está conectado al polo negativo (6) de la misma.
- e) El cuerpo de la celda (A) contiene un orificio de desahogo (7) el cual permite que la presión atmosférica ayude a la extracción del cloro gaseoso que será extraído por un inyector Venturi.
- f) La tapa (8) de la celda tiene en cada uno de sus extremos dos orificios:
  1. En la celda (A)
    - Orificio alimentador para cloruro de sodio (9)
    - Orificio para la salida de cloro gaseoso (10)
    -
  2. En la celda (B)
    - Orificio alimentador para hidróxido de sodio (11)
    - Orificio para la salida de hidrógeno gaseoso (12)

## INSTRUCCIONES DE OPERACION

1. Disolver 900 gramos de cloruro de sodio en 3 litros de agua destilada y depositarlos en la celda (A).
2. Disolver 300 gramos de hidróxido de sodio en 3 litros de agua destilada y depositarlos en la celda (B).
3. Colocar la tapa (8) de la celda, de manera tal que el electrodo de grafito (2) quede sumerfido en el cloruro de sodio y el de acero inoxidable (4) en el hidróxido de sodio.
4. Conectar el electrodo de grafito (2) al polo positivo (5) de la fuente reguladora.
5. Conectar el electrodo de acero inoxidable (4) al polo negativo (6) de la fuente reguladora.
6. Conectar la manguera de succión del cloro a la celda (A) y al eyector Venturi.
7. Tapar los orificios de alimentación (9) y (11) de las celdas con sus respectivos tapones.
8. Dejar libre el orificio (12) de salida de hidrógeno.
9. Permitir el paso del agua a través del eyector Venturi.
10. Conectar la fuente reguladora.

NOTA:

La producción de cloro es proporcional a la intensidad de corriente o amperes que sean pasados a través de la celda; es decir a mayor amperaje, mayor producción de cloro y viceversa.

- Iniciada la operación de la celda, esperar 10 minutos para determinar cloro.
- Comenzar con la toma más cercana a la instalación e ir avanzando a tomas domiciliarias más alejadas para determinar los amperes en la cual la celda debe trabajar, procurando no exceder los 7 amperes de alimentación.

## MANTENIMIENTO DE LA CELDA ELECTROLITICA

- Proporcionar mantenimiento cada 100 horas de funcionamiento de la celda. Esto depende de la calidad de la sal utilizada, ya que algunas marcas del mercado presentan más impurezas que otras.
- Apagar y desconectar la fuente reguladora de voltaje.
- Desmontar las conexiones eléctricas de ambos electrodos (2) y (4).
- Desconectar todas las mangueras o conexiones que estén sobre la tapa (8) de la celda.
- Desmontar la tapa de la celda.
- Desechar las soluciones de las celdas (A) y (B) por medio de los tapones de desagüe (13).
- Enjuagar con chorro de agua ambas celdas (A) y (B) y desaguar nuevamente.
- Desmontar el portamembrana (1) y a chorro de agua, lavese.
- Secar las celdas (A) y (B) y el portamembrana (1)
- Volver a montar el portamembrana (1) respetando la colocación inicial, ya que la membrana Nafion (3) tiene funciones diferentes en cada uno de sus lados.
- Sellar con silicón las uniones del portamembrana (1) a su soporte para no permitir fugas por las uniones.
- Asegurar que el material rojo de empaque esté ubicado en su lugar, o en su defecto sellarlo con silicón.
- Si es necesario, reemplazar o reparar las conexiones y cables eléctricos que conectan los electrodos.



## RECOMENDACIONES

- El cloro es un gas (mortal) más pesado que el aire; por lo que si se presenta una fuga debe desconectar inmediatamente la fuente reguladora de voltaje, permitir una ventilación abundante y abandonar el área.
  - El cloruro de sodio se adiciona de acuerdo al control que se tenga de cloro residual en las tomas domiciliarias, pero es conveniente cambiarlo cada 8 días.
  - El hidróxido de sodio es una solución que produce quemaduras graves en la piel u ojos por lo que se debe lavar inmediatamente con abundante agua la zona afectada. En la piel aplicar una solución al 50% de ácido acético y en y en los ojos una solución de 30 grs de bicarbonato en un litro de agua potable.
  - Cada 10 días se diluye el hidróxido de sodio con 50 ml. de agua ya que éste aumenta su concentración.
  - En ciertas proporciones, el hidrógeno puede ser explosivo, por tal motivo no debe ser retenido; ni fumar en el área de ubicación de la celda.
- No tocar ninguna de las soluciones con los dedos cuando este funcionando la celda, ya que existe riesgo de electrocutarse.
- Al desechar las soluciones, tenga precaución de no salpicarse ya que existe el riesgo de quemaduras.

- El orificio contenido en el cuerpo de la celda no debe estar obstruido.
- Al estar la celda fuera de operación, se debe retirar uno de los cables de los electrodos de la fuente reguladora de voltaje.
- Es recomendable usar sal no yodatada (de grano).
- Al lavar el portamembrana no utilice cepillos ni otros objetos ya que se puede romper la membrana.

## ACCESORIOS Y REACTIVOS

1. Fuente reguladora de ~~energía~~ corriente
2. Manguera de 1/4 de pulgada para la succión del gas cloro.
3. Solución de cloruro de sodio, ~~de concentración de grado químicamente puro.~~
4. Solución de hidróxido de sodio.

A	AUPER	ELECTRODO	M E T O D O				ORTOTOLIDINA		
			YODOMETRICO	D P D	ORTOTOLIDINA				
			Ci2 TOTAL mg./l.	mg. de Ci2/seg.	Ci2 TOTAL mg./l.	mg. de Ci2/seg.	Ci2 TOTAL mg./l.	mg. de Ci2/seg.	
1		Ti-Rod <del>io</del>	5.319	0.7595	5	4.7	0.714	6	0.2558
1		Ti-Rod <del>io</del>	5.319	0.7595	5	4.8	0.714	6	0.3558
1		Grafito	2.6595	0.3797	1.6	1.5	0.228	2	0.2956
1		Moggo	3.546	0.5063	3	2.7	0.4282	4	
3		Ti-Rod <del>io</del>	8.865	1.2659	8	7	1.1424	8	1.1424
3		Ti-Ir	10.638	1.5191	10	9	1.428	10	1.428
3		Grafito	6.2055	0.8861	6	5.7	0.8568	6	0.8568
3		Moggo	7.092	1.0127	7	6.6	0.9996	6	0.8552
5		Ti-Rod <del>io</del>	17.73	2.531	16	15.4	2.2949	16	2.2949
5		Ti-Ir	14.184	2.025	13	12.8	1.8564	14	1.9332
5		Grafito	12.411	1.7722	12	11.7	1.7136	12	1.7136
5		Moggo							
7		Ti-Rod <del>io</del>	18.616	2.6583	18	17.7	2.5704	18	2.5704
7		Ti-Ir	22.162	3.1647	20	19.8	2.856	18	2.5704
7		Grafito	15.957	2.2786	14	13.8	1.992	12	1.7136
7		Moggo	18.721	2.6621	17	16.6	2.6401	18	2.3615

ISOMETRICO

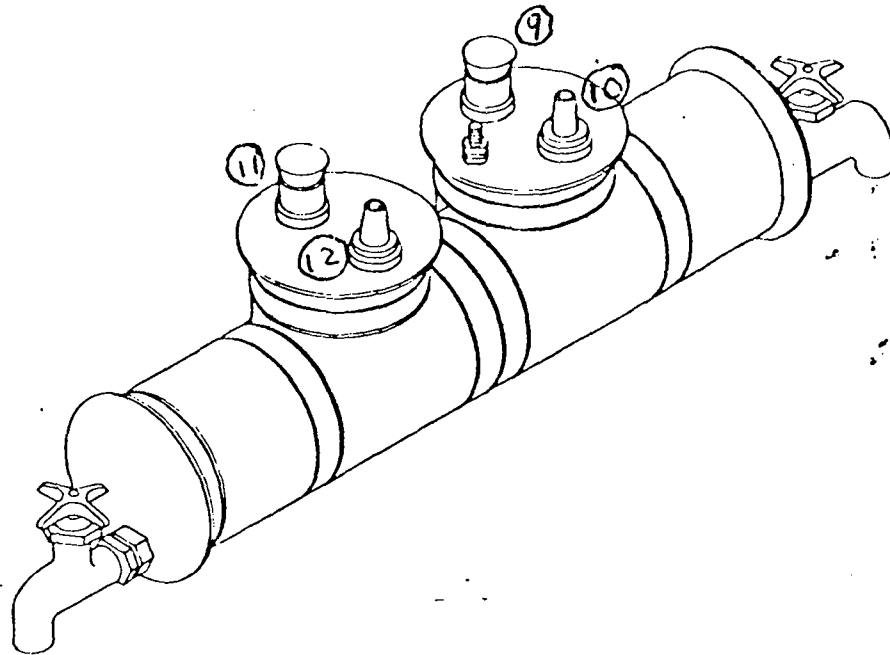
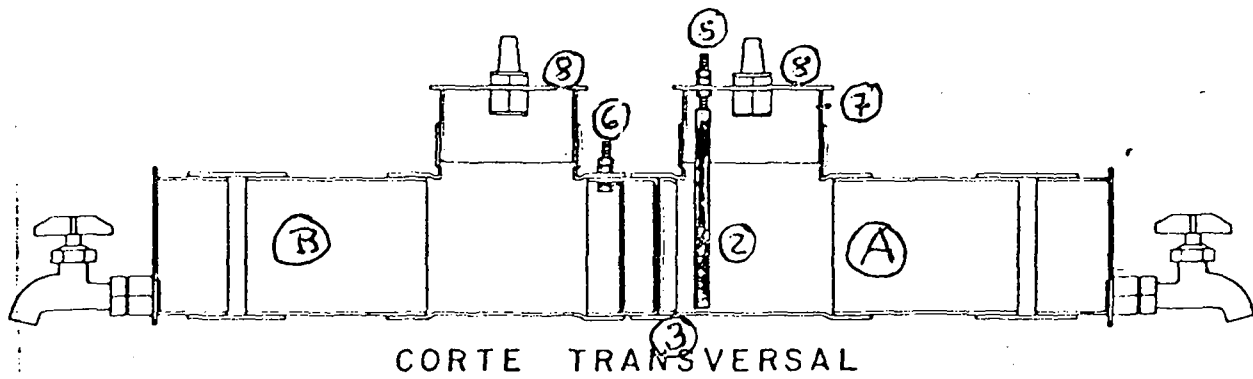


FIGURA 5



CORTE TRANSVERSAL

FIG. 6

CELDA ELECTROLITICA



METODO CEDAT

Nº	VOL. DE AGUA TRATADA (GASTO)	ANALISIS BACTERIOLOGICO			AGUA BACTERIOLOGICAMENTE APTA PARA CONSUMO HUMANO
		VOL. DE LA MUESTRA	COLIFORMES TOTALES	COLIFORMES FECALES	
1					
2					
3					
4					
5					
6					
7					
8					
9					
10					
11					
12					
13					
14					
15					
16					
17					
18					
19					
20					
21					
22					
23					
24					
25					
26					

OPERACION Y MANTENIMIENTO  
DE EQUIPOS OZONOCOLORADORES

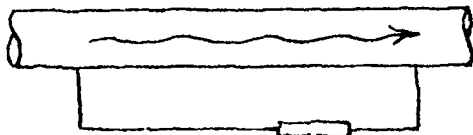
Cartilla simplificada para  
operadores de planta



OPERACION

Recordar . . .

EL EQUIPO SOLO DEBE ESTAR FUNCIONANDO SI EL AGUA A TRATAR ESTA CIRCULANDO



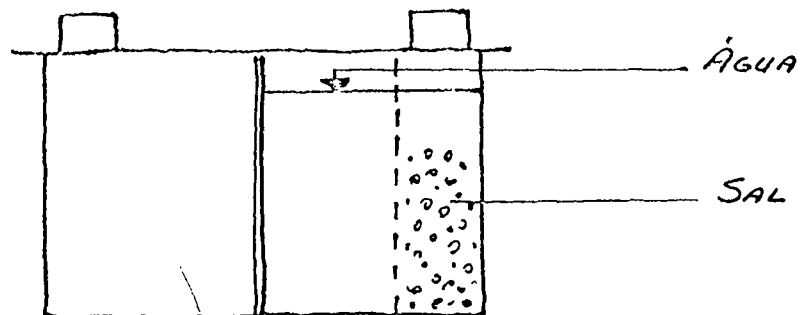
ENCENDIDO



APAGADO

Controles diarios:

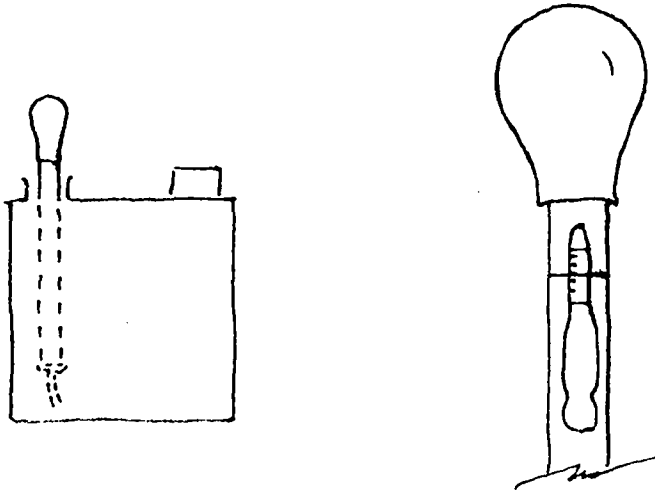
1. QUE LA CELDA TENGA AGUA Y SAL



Si no tuviera, se deberán agregar!

## 2. LA DENSIDAD DE LA SOLUCION DE SODA

Para ello use el densímetro. Saque la tapa e introduzca el densímetro hasta el fondo en el compartimento de la solución de soda. Apriete la pera de goma y deje que el líquido entre en el tubo

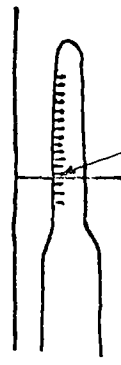


El nivel del líquido debe estar dentro de la zona verde en los equipos GIDOX ó dentro de los valores 1050 - 1125 en los equipos OXI.

Cuando la solución esté muy densa ocurrirá que el nivel estará



EQUIPOS GIDOX



EQUIPOS OXI

Cuando esto ocurra, habrá que diluir la solución de soda. Para ello:

AGREGUE AGUA HASTA QUE LA DENSIDAD ESTE DENTRO DE LOS VALORES ACONSEJADOS

(Vol. de agua a agregar =  $\frac{1}{3}$  -  $\frac{1}{2}$  del volumen de la cámara de soda)

MANTENIMIENTO (OXI)

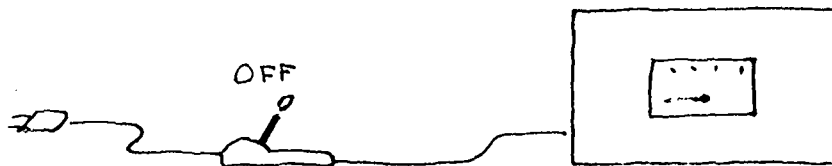
Frecuencia

De acuerdo al tipo de sal usada será la frecuencia de mantenimiento:

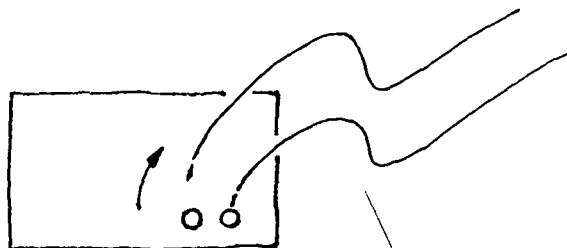
SAL PURIFICADA STERLING = CADA 5 MESES DE OPERACION CONTINUA

SAL COMERCIAL COMUN = cada 1 MES DE OPERACION CONTINUA

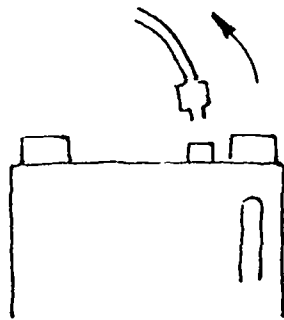
La forma de realizarla ...



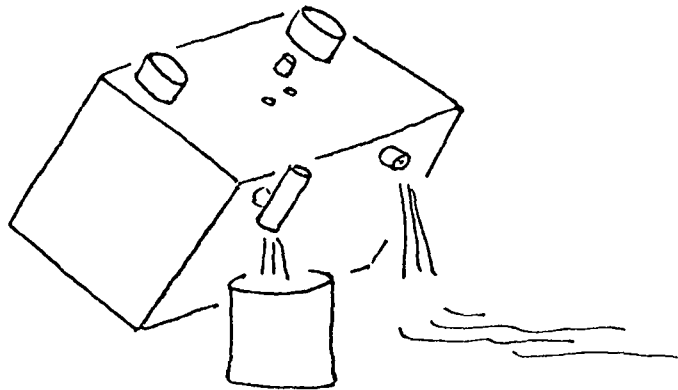
1. CORTE LA CORRIENTE



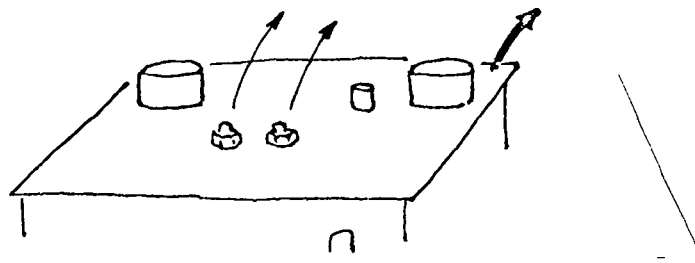
2. DESCONECTE LOS CABLES ELECTRICOS AFLOJANDO LAS TUERCAS EN LA PARTE POSTERIOR DEL COMANDO Y RETIRELOS.



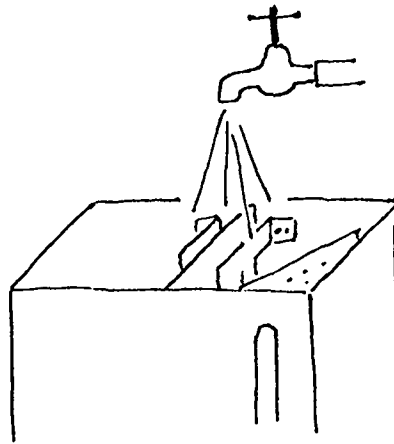
3. DESCONECTE EL TUBO DE LOS GASES EN LA TAPA DE LA CELDA.



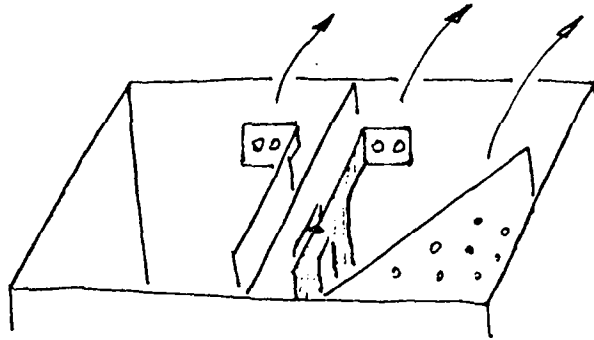
4. INCLINE LA CELDA DE FORMA QUE LAS SOLUCIONES EN AMBOS COMPARTIMIENTOS SALGAN POR LOS DESBORDES. COLOQUE UN RECIPIENTE EN LA DESCARGA DE LA SODA PUES ESTA SOLUCION VOLVERA A SER UTILIZADA. LA OTRA SOLUCION SE DESCARTARA.



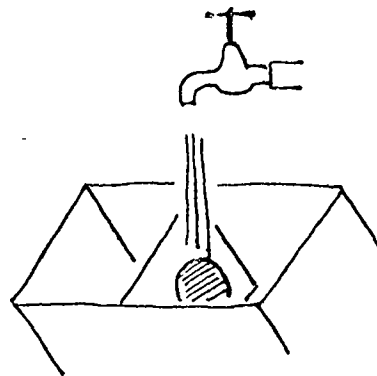
5. QUITA LAS TUERCAS DE LA TAPA Y RETIRE LA MISMA.



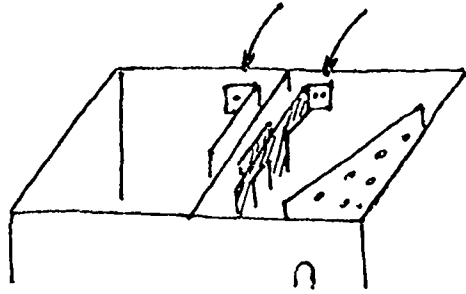
6. ENJUAGUE EL INTERIOR CON AGUA.



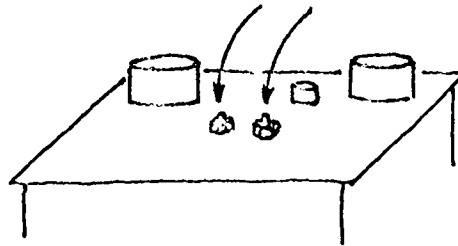
7. REMUEVA LOS ELECTRODOS QUITANDO LAS TUERCAS QUE LO SUJETAN, PARA QUE LA MEMBRANA QUEDE ACCESIBLE. PUEDE QUITAR TAMBIEN EL DIVISOR PARA LA SAL.



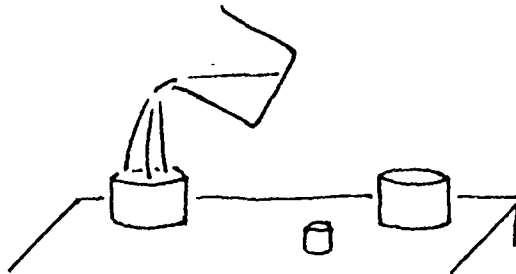
8. ENJUAGUE LA MEMBRANA DE AMBOS LADOS DEJANDO CAER CHORROS DE AGUA SOBRE LA MISMA. PERO NO TOQUE NI RASPE LA MEMBRANA. SI LO HACE, LA MEMBRANA SE MALOGRA Y TODO EL EQUIPO QUEDARA INUTILIZADO



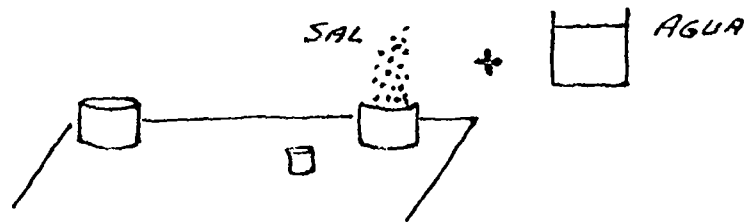
9. REINSTALE EL DIVISOR PARA LA SAL Y LOS ELECTRODOS. ATENCION: EL ELECTRODO DOBLE DEBE IR EN EL COMPARTIMENTO DE LA SAL.



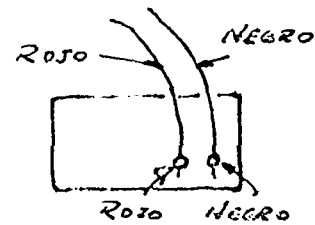
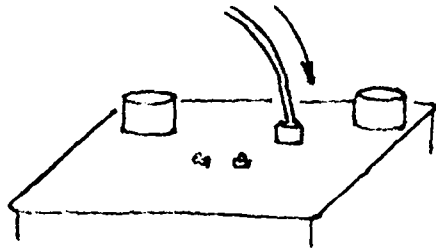
10. COLOQUE LA TAPA Y ASEGURELA POR MEDIO DE LAS TUERCAS.



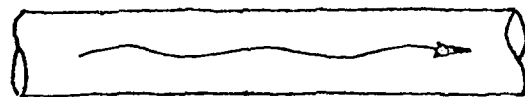
11. ECHE LA SOLUCION DE SODA QUE HABIA GUARDADO EN EL COMPARTIMENTO CORRESPONDIENTE. APROVECHE PARA MEDIR LA DENSIDAD. SI ESTUVIERA MUY DENSA: DILUYALA.



12. LLENE CON SAL EL COMPARTIMENTO DE SAL Y LUEGO LLENE ESE COMPARTI MENTO CON AGUA.



13. CONECTE EL TUBO DE LOS CASES Y LAS CONEXIONES ELECTRICAS (CABLE ROJO AL TERMINAL ROJO Y CABLE NEGRO AL TERMINAL NEGRO).



14. CONECTE LA CORRIENTE Y REINICIE LA OPERACION. ASEGURESE DE QUE POR LA TUBERIA CIRCULA EL AGUA A TRATAR.

\* \* \* \* \*

MANTENIMIENTO (GIDOX)

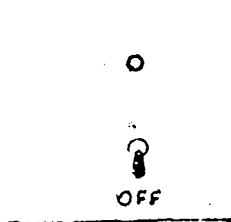
Frecuencia

De acuerdo al tipo de sal usada será la frecuencia de mantenimiento:

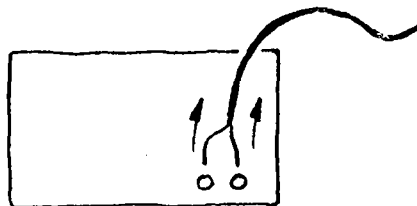
SAL PURIFICADA STERLING = CADA 5 MESES DE OPERACION CONTINUA

SAL COMERCIAL COMUN = CADA 1 MES DE OPERACION CONTINUA

La forma de realizarla . . .

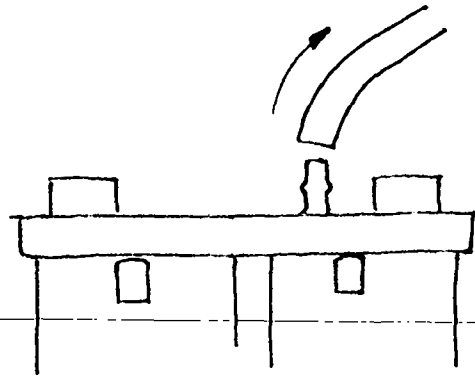


1. APAGUE EL EQUIPO LLEVANDO A LA POSICION OFF LA LLAVE EN EL MODULO DE COMANDO.

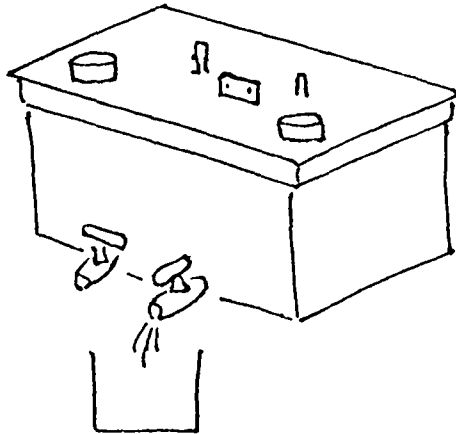


2. DESCONECTE LOS CALBES ELECTRICOS AFLOJANDO LAS TUERCAS EN LA PARTE POSTERIOR DEL COMANDO Y RETIRELOS.

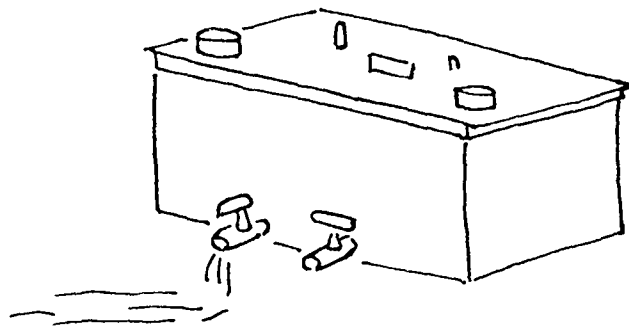




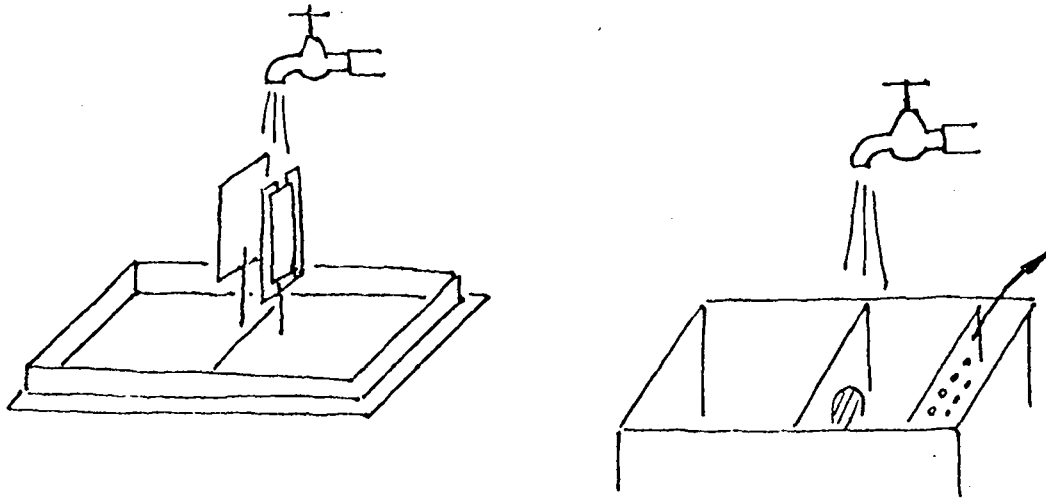
3. DESCONECTE EL TUBO DE LOS GASES EN LA TAPA DE LA CELDA.



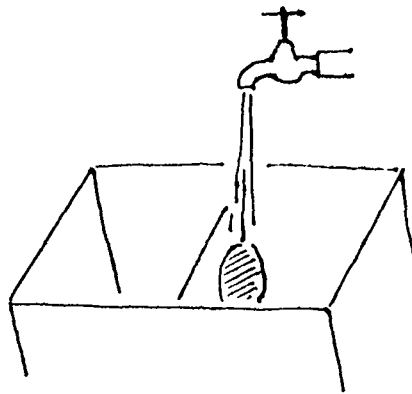
4. DESAGOTE LA SOLUCION DE SODA POR MEDIO DE LA VALVULA EN LA PARTE POSTERIOR DE LA CELDA. COLOQUE UN RECIPIENTE EN LA DESCARGA, PUES ESTA SOLUCION VOLVERA A SER UTILIZADA.



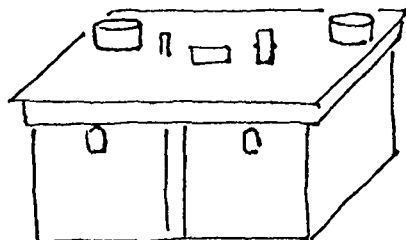
5. DESAGOTE LA SOLUCION SALINA POR MEDIO DE LA OTRA VALVULA. DESCARTE ESTA SOLUCION.



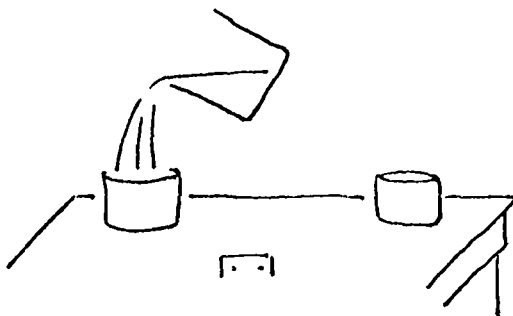
6. ENJUAGUE EL INTERIOR DE LA TAPA Y EL INTERIOR DE LA CAJA. PUEDE QUITAR EL DIVISOR PARA LA SAL PARA FACILITAR LA OPERACION.



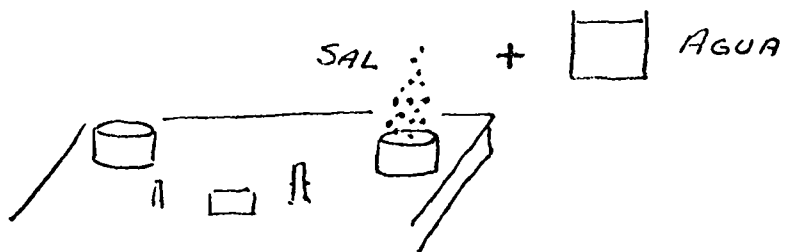
7. ENJUAGUE LA MEMBRANA DE AMBOS LADOS DEJANDO CAER CHORROS DE AGUA SOBRE LA MISMA. PERO NO TOQUE NI RASPE LA MEMBRANA. SI LA MEMBRANA SE MALOGRA TODO EL EQUIPO QUEDARA INUTILIZADO.



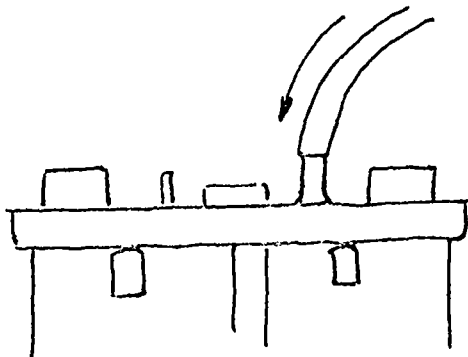
8. REINSTALE EL DIVISOR PARA LA SAL Y COLOQUE LA TAPA.



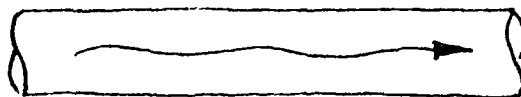
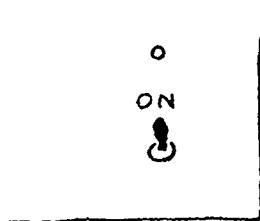
9. ECHE LA SOLUCION DE SODA QUE HABIA GUARDADO EN EL COMPARTIMENTO CORRESPONDIENTE. APROVECHE PARA MEDIR LA DENSIDAD. SI ESTUVIERA MUY DENSA: DILUYALA.



10. LLENE CON SAL EL COMPARTIMENTO DE SAL Y LUEGO LLENE ESE COMPARTI MENTO CON AGUA.



11. CONECTE EL TUBO DE LOS GASES Y LAS CONEXIONES ELECTRICAS.

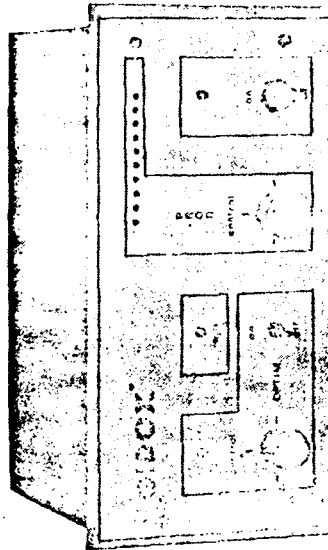
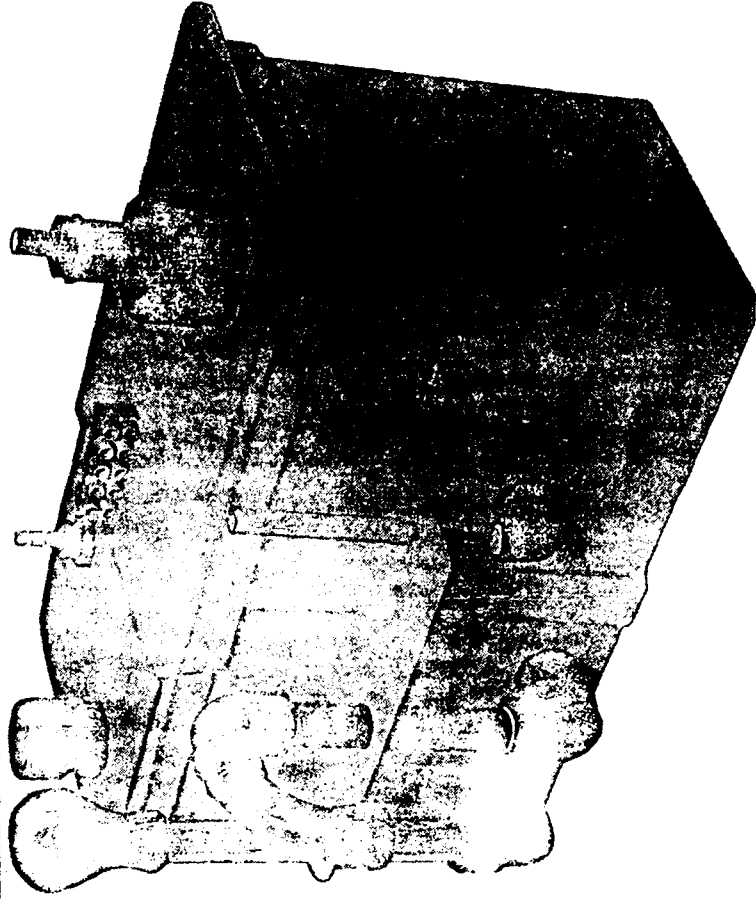


12. REINICIE LA OPERACION ENCENDIENDO EL EQUIPO POR MEDIO DE LA LLAVE EN EL MODULO DE COMANDO (A LA POSICION ON). ASEGURESE DE QUE POR LA TUBERIA CIRCULA EL AGUA A TRATAR.

\* \* \* \* \*

EVOLUCION

**LA AVANZADA TECNOLOGICA  
EN TRATAMIENTO DE AGUAS**



GEOSOX

GIDOX es algo mas que un nuevo equipo. Es un novedoso sistema que está revolucionando la desinfección de las aguas. Los países de avanzada tratan sus aguas de consumo con dos técnicas independientes y sucesivas: ozonización y cloración, logrando una altísima eficacia tanto en la eliminación de germen presentes como en la calidad de agua obtenida, ya que el ozono destruye los microbios en general y el cloro provee un residual que elimina eventuales contaminaciones en las redes de distribución.

El uso del ozono y del cloro es asimismo ideal para eliminar sustancias oxidables tanto orgánicas como inorgánicas, tales como hierro, manganeso, ácido sulfhídrico, cianuros, fenoles, insecticidas, detergentes, amoníaco, etc.

Lo novedoso de GIDOX es generar una mezcla abundante de gases oxidantes (ozono, peróxido de hidrogeno, cloro y dióxido de cloro) combinando ambos procesos (la ozonización y la cloración) en uno solo.

Lo extraordinario del sistema es que tan efectiva mezcla se produce a partir de materias existentes en cualquier lugar del mundo: AIRE, AGUA, SAL COMÚN y ELECTRICIDAD. Esto elimina los problemas de importación en aquellos países en donde no se producen las sustancias desinfectantes, a la vez que soluciona el inconveniente del acarreo y el riesgo de almacenamiento y manipulación de peligrosos compuestos químicos (cloro o cloro derivados).

GIDOX es una celda de tipo electrolítico dividida en dos semiceldas, que descompone la sal común y el agua por el pasaje de electricidad de bajo voltaje comandada por un modulo de control

El proceso electrolítico produce en una semicelda dos subproductos que se descartan: hidróxido de sodio e hidrógeno mientras que en la segunda semicelda se genera la mezcla oxidante, la cual, conducida a través de una apropiada conexión, es introducida en una cañería por donde circula el agua a tratar. Su robusta construcción asegura una muy larga vida al equipo y su sistema modular desarmable permite el rapido intercambio de cualquiera de sus componentes.

Para su instalación solo se requiere intercalar un inyector tipo

GIDOX is something more than a new equipment. It is a novel system that is producing a revolution in water disinfection.

The most developed countries treat their drinking water with two independent and successive techniques: ozonization and chlorination; obtaining thus a very high efficiency in the germ elimination as well as in the water quality, due to the fact that the ozone destroys the microbes, and the chlorine provides a residual that copes up with eventual contaminations in the distribution system. The use of ozone and chlorine is also ideal to remove oxidable organic and inorganic substances, such as iron, manganese, sulphuric acid, cyanides, phenols, insecticides, detergents, ammonia, etc.

The novelty of GIDOX, is that it produces an abundant mixture of oxidant gases (ozone, hydrogen peroxide, chlorine and chlorine dioxide), combining both processes (ozonization and chlorination) in only one.

The outstanding fact of this system is that such effective mixture is produced out of materials that are present everywhere in the world: AIR, WATER, SALT and ELECTRICITY.

This eliminates problems of importing in those countries where disinfecting substances are not produced, and provides a solution to transport, storage and handling of dangerous chemicals (chlorine and chlorine derivatives).

GIDOX is an electrolytic cell divided into two semicells that using low voltage electricity commanded by a control unit decomposes the water and the salt.

In one of the semicells, the electrolysis produces sodium hydroxide and hydrogen, two by-products to be discarded, while in the second semicell the oxidant mixture is produced, and, conducted through a proper connection is injected in a duct where the water to be treated is flowing.

A sturdy structure ensures a durable life, and its modular system allows the change of any of its components.

In order to install the equipment, a venturi type injector must be inserted directly in the circuit of water to be treated or it

venturi (que se provee con el equipo y que aspirará los gases producidos en la celda), ya sea en el circuito del agua a tratar o en una derivación; y luego conectar este inyector con el equipo.

Luego de llenar la celda con agua se agrega en una de las semiceldas sal común y en la otra hidróxido de sodio sólido (que se provee con el equipo). Esto último se realiza solamente la primera vez en que se pone en funcionamiento el aparato.

El módulo de control se conecta a la red eléctrica (220 ó 110 V) y al equipo. La producción de gases se regulará mediante una perilla ubicada en este módulo.

- La operación se reduce a:
- Agregar sal cuando haga falta
  - Verificar el nivel del agua en una de las semiceldas y agregar más si fuera necesario.
  - Controlar la densidad de la solución en el segundo comparativo y en caso necesario diluir mediante el agregado de agua. (El densímetro está incorporado al equipo).
- La frecuencia de estas operaciones puede oscilar entre 1 y 4 veces por semana.

Tiempo de cada operación completa: 1 minuto!

El mantenimiento de los equipos GIDOX se reduce a desagotar la celda y efectuar un enjuague del interior de la misma bajo un chorro de agua; luego de lo cual se colocan nuevamente las soluciones en su interior y se reinicia el funcionamiento.

La frecuencia de las operaciones de mantenimiento es de 1 a 4 veces por mes.

Tiempo total del mantenimiento: 3 minutos!

Un modelo para cada necesidad: desde el uso familiar hasta el tratamiento de agua de plantas potabilizadoras de hasta 10.000 habitantes por unidad.

GIDOX encontrará ideal aplicación en perforaciones y sistemas domiciliarios, plantas de tratamiento de aguas, establecimientos industriales (afluentes y efluentes), desagües cloacales y piscinas de natación.

can be installed on a by-pass on that same circuit; and then connected to the cell.

This venturi is provided with the equipment, and its function is absorbing the gases produced in the cell.

After filling the cell with water, common salt is added to one of the semicells, while in the other solid sodium hydroxide (provided also with the equipment) is dissolved. This last step is performed only the first time the electrolysis is started.

The control unit is connected to the electric power (220 or 110 V) and to the equipment.

The rate of generation of gas is set by a dial in the control unit. The operation is reduced to:

- Add more salt when needed
- Verify the water level in one of the semicells and add more if needed
- Control the second semicell density solution and dilute with water if necessary (The densimeter is incorporated in the equipment).

The frequency of these operations may vary from 1 to 4 times a week.

Time required for a complete operation: 1 minute!

The GIDOX maintenance is reduced to empty the solutions from the cell and wash its interior under a water jet. Then the solutions are replaced inside and operation is restarted.

The maintenance frequency is from 1 to 4 times a month.

Time required for maintenance: 3 minutes!

A model for every need: from family use to water treatment plants for populations up to 10,000 inhabitants in one single unit.

GIDOX is ideal for drilled-wells, house systems, water treatment plants, water for industrial consumption and industrial effluents, sewage, and swimming pools.

# GIDOX

## CARACTERÍSTICAS TÉCNICAS - Technical Characteristics

MODELO Model.	DIMENSIONES L x A x h Size LxWxh (cm)	CONSUMO DE ENERGÍA A MÁXIMA PRODUCCIÓN Energy consumption at maximum production rate (Watt-hour) (Watt-hour)	PRODUCCIÓN MÁXIMA DE OXIDANTE/DÍA Maximum oxidant production/day (Gr/día) (Gr/day)	POBLACION EQUIVALENTE* Equivalent population** (Habitantes) (Inhabitants)
GIDOX - 5	38 x 40 x 35	50	200	2000
GIDOX - 10	43 x 41 x 36	110	400	4000
GIDOX - 15	47 x 45 x 38	180	550	5500
GIDOX - 30	64 x 53 x 38	360	1000	10000

\* Es la cantidad de habitantes que pueden obtener agua desinfectada suponiendo una Demanda de 1 mg/litro y una Dotación de 100 litros/Habitante x Día.  
 \*\* Quantity of persons that can be supplied with disinfected water considering a Demand of 1 mg/litre and an Average Daily Consumption of 100 litres/Inhabitant x Day.

### SEJUELA

#### ORGANIZACION PANAMERICANA DE LA SALUD

"Numerosos prototipos de GIDOX han funcionado en campaña con mínima atención de operación por más de tres años sin virtualmente presentar problemas".

"...es plausible reconocer que una mezcla de desinfectantes sea más efectiva en una gran variedad de condiciones que un desinfectante aislado..."

"Desde el punto de vista de la salud, GIDOX es tan beneficioso y seguro como el uso del cloro".

Reproducido de "Hojas de Divulgación Técnica" OPS-CEPIS # 32-1986

### According to the

#### PAN AMERICAN HEALTH ORGANIZATION

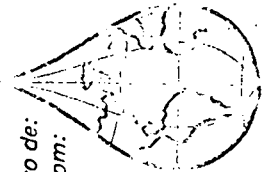
"Several prototypes of GIDOX unit have performed under actual field operating conditions with minimal operator attention and yet with virtually no problems for more than three years".

"...it seems plausible that a mixture of disinfectants is more effective over a wider range of conditions than one single type".

"From a health standpoint, GIDOX should prove at least as beneficial and safe as chlorine".

From the Bulletin "Technical Information" (Hojas de Divulgación Técnica). PAHO-CEPIS # 32-1986

Es un producto de:  
A product from:



TECNOLOGIA EN AGUAS  
Water Technology

Paysandú 2361 - (1416) Buenos Aires - ARGENTINA  
Telefono - Phone (01) 59-2154





LISTA DE PRECIOS

(VALORES F.O.B. EN DOLARES AMERICANOS)

OZONOLABORES GIDOX

MODELO	PRODUCCION (GR/DIA)	CELDA CON MODULO	PRECIO
G-2	100	C-A	472.-
G-5	200	C-1	795.-
		C-2	895.-
		C-3	945.-
G-10	400	C-1	940.-
		C-2	1045.-
		C-3	1095.-
G-15	550	C-1	1210.-
		C-2	1315.-
		C-3	1380.-
G-30	1000	C-1	1510.-
		C-2	1625.-
		C-3	1690.-

OPCIONALES:

BUZZER: Adaptación para buzzer y buzzer incluido

(en celdas con módulo C-3)

PRODUCCION DEMANDA CAUDAL: Adaptación para conexión

a caudalímetro)

PLANTAS COMPACTAS POTABILIZADORAS

MODELO	CAUDAL (M <sup>3</sup> /H)	ELEMENTOS	PRECIO
PCP-1	1	Bomba-Floc/Sed-Filtro-GIDOX	4000.-
PCP-5	5	Idem	5000.-

Los precios incluyen embalaje, gastos administrativos en puerto de embarque y el seguro hasta puerto de destino.

FENAR SA - Julio 1987

FENAR S.A. - Tecnología en Aguas

ESTOMBA 1949

Administración y Ventas: PAYSANDU 2361

TEL. 59-2154

(1416) BUENOS AIRES ARGENTINA

# De l'Agua

water quality for  
developing countries

Directors B J Lloyd PhD  
M Pardon BSc  
D Wheeler BSc

Address PO Box 92  
Guildford  
GU2 5TQ  
England

Our Reference:

Your Reference:

Date:

## VIGILANCIA DE CALIDAD DEL AGUA

Uno de los pilares fundamentales de la estrategia a fin de alcanzar las metas propuestas para la Década del Agua (decenio 1981-1990) es la vigilancia de calidad de agua de consumo humano que se distribuye a las poblaciones.

En mayor o menor medida, los Países en vías de desarrollo se enfrentan a problemas que les impiden implementar en forma adecuada programas de esta naturaleza. En algunos casos, es la falta de personal técnico entrenado adecuadamente; en otros, los costos de equipos e insumos hacen prohibitiva la implementación de estos programas de vigilancia.

De l'Agua es una organización sin fines de lucro basada en Inglaterra cuyos tres objetivos principales son: apoyar Programas de Vigilancia de Calidad de Agua con cursos cortos de entrenamiento en temas relacionados a vigilancia y técnicas analíticas de monitoreo; suministro de equipos de monitoreo al precio de costo de manufactura; y respaldo de insumos para los Programas, suministrándolos a precios de descuento obtenidos en el Reino Unido. Las especificaciones del equipo así como las características de los cursos de entrenamiento y del apoyo que se ofrece se detallan en las páginas siguientes.

Información adicional se puede solicitar a la dirección postal arriba señalada o a:

Mauricio Pardón  
c/o CEPIS  
Casilla Postal 4337  
Lima 100, Perú  
Telex: 21052 PE CEPIS  
Teléfono: 35-4135

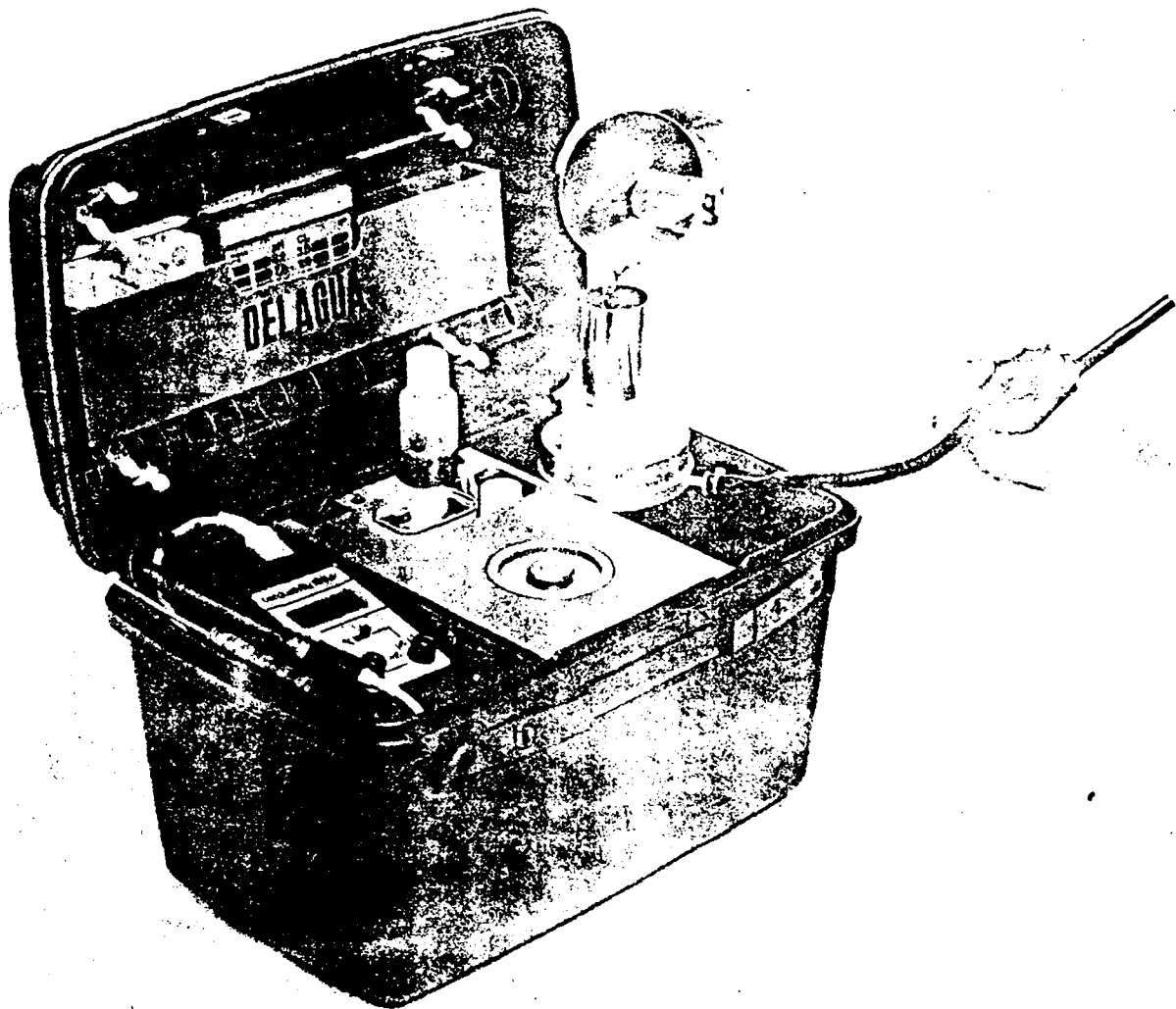
# DelAgua

water quality for  
developing countries

Directors B J Lloyd PhD  
M Pardon BSc  
D Wheeler BSc

Address PO Box 92  
Guildford  
GU2 5TQ  
England

## PORTABLE WATER TESTING KIT



### Components:

- 1: Faecal coliform bacteriology  
Membrane filtration equipment and 44°C integral incubator  
and 12 volt battery + separate charger
- 2: Combination chlorine residual and pH comparator.
- 3: Turbidimeter tubes: High range 20-2000 T.U.  
Low range <10
- 4: Combination electronic temperature and conductivity meter  
Low range 0 - 200  $\mu$ S  
Medium range 200 - 2,000  $\mu$ S  
High range 2,000 - 20,000  $\mu$ S

DelAgua is a non-profitmaking organisation concerned with training consultancy in water treatment, water quality surveillance and sanitation in developing countries.

Registered Number 1860842

Registered Offices 128 High Street Guildford UK

## DELAGUA PUBLIC HEALTH TRAINING PROGRAMMES

### Specification of analytical equipment for water testing schemes

- Faecal coliform test - Performed by the membrane filtration technique using integral, purpose made filtration apparatus.
- Incubator section - Kits incorporate incubators which permit the incubation of up to 17 membranes within reusable aluminium petri dishes.
- Chlorine residual - Performed by a simple comparator method using DPD reagents - results in mg/l.
- Turbidity - Performed by a tube/extinction method for the range 5 - 5000 TU.
- Filterability - For use in conjunction with turbidity for process selection - based on a membrane filtration technique.
- Conductivity - Performed using a robust electronic meter and probe.
- Temperature - Performed using a robust electronic meter and probe.
- pH - Performed by a simple comparator method using phenol red reagent.

The water testing kit is supplied with an integral rechargeable battery, and is capable of independent field operation for a minimum of five days before recharging is necessary. Charging is performed from mains electricity (110 or 220 volts AC) using a matched charger unit which is supplied.

The check list of equipment normally contained within the DELAGUA water testing kit is shown overleaf.

## CHECK LIST OF EQUIPMENT

<u>Item</u>	<u>Quantity</u>	
1: Carrying case with incubator		
2: Membrane Filters		Consumables
3: Pads and Dispenser		Consumables
4: Forceps		
5: Aluminium Petri Dishes		
6: Gas Lighter		
7: Sample Jug and Cable		
8: Filtration Tube		
9: Tube Support		
a: Upper 'O' ring		
b: Lower 'O' ring		
c: Membrane support		
10: Methanol Dispenser		
11: Suction Pump		
12: Suction cup		
13: Turbidity tube		
14: Culture Medium (in small autoclavable bottles)		
15: Chlorine ) ) comparator		
16: pH )		
17: DPD pastilles No. 1		Consumables
18: DPD pastilles No. 4		Consumables
19: pH pastilles Phenol Red		Consumables
20: Conductivity) ) meter		
21: Temperature )		
22: Conductivity electrode		
23: Temperature Probe		
24: Tissue/Clean Cloth		Consumables

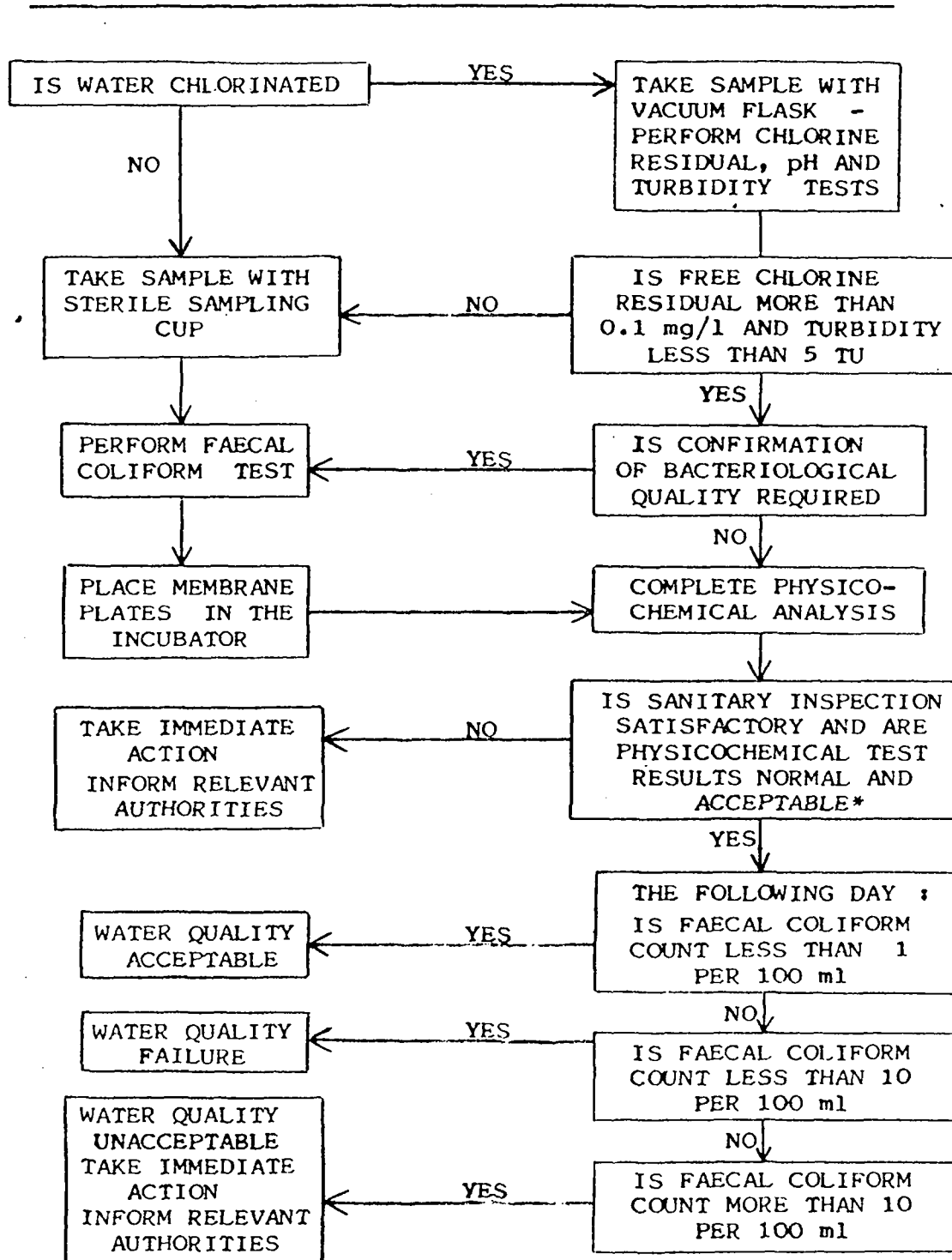
# DelAgua

water quality for.  
developing countries

Directors B J Lloyd PhD  
M Pardon BSc  
D Wheeler BSc

Address PO Box 92  
Guildford  
GU2 5TQ  
England

## CHECKLIST FOR THE OPERATION OF THE 'DELAGUA' WATER TESTING KIT



\* ACCEPTABILITY IS JUDGED BY NORMAL WHO CRITERIA

# DelAgua

water quality for  
developing countries

Directors B J Lloyd PhD  
M Pardon BSc  
D Wheeler BSc

Address PO Box 92  
Guildford  
GU2 5TQ  
England

## DEL AGUA PUBLIC HEALTH TRAINING PROGRAMMES

DelAgua is a non-profitmaking organisation. The following represent only those charges necessary to cover costs.

Training programmes conducted in-country include provision of up to two weeks tuition in public health science, sanitary inspection, water treatment technology, water quality testing, monitoring and surveillance. Any aspect can be emphasised according to the requirements of the commissioning agency.

### CHARGES

Travel and subsistence of two instructors (Latin America)	.....	*
Equipment (per unit)	.....	1000 USD
Air freighting and insurance for equipment (per unit)	.....	250 USD
Course fee for materials (per student)	.....	62.5 USD

\* based on travel fares plus U.N. subsistence allowance rates

# DelAgua

water quality for  
developing countries

Directors B J Lloyd PhD  
M Pardon BSc  
D Wheeler BSc

Address PO Box 92  
Guildford  
GU2 5TQ  
England

## DEL AGUA PUBLIC HEALTH TRAINING PROGRAMMES

The following topics and exercises will be incorporated into the two week training programme;

Introduction; water-borne and water associated disease; The faecal-oral route of infection; Infective doses; Faecal indicators and pathogens in water; The International Water Decade - goals, legislation and standards; GEMS.

Water treatment; the multiple barrier principle; Treatment process selection for rural and sub-provincial water treatment works; Treatment process design, operation and maintenance; prefiltration, slow sand filtration and disinfection; Commissioning and monitoring (quality control); Laboratory exercise on disinfection.

Sanitary inspection; Field visit for sanitarian duties and reporting results; Infrastructural requirements for action on maintenance and repairs.

Water quality monitoring and surveillance; Definition of roles of supply agency and health authorities; Water quality testing; World Health Organisation Guidelines; Volumes I-III.

Water testing; Bacteriology; Field preparation of media; Sterilisation of media; Packaging, checking, and maintenance of testing equipment.

Water testing; Physico-chemical parameters; Field exercises involving sampling of raw, treated, and distributed water samples; Reporting results.

Relevance of standards; Interpretation of water quality results; Formulation of sampling programmes; Water quality and health.



# DelAgua

*water quality for  
developing countries*

*Directors* B J Lloyd PhD  
M Pardon BSc  
D Wheeler BSc

*Address* PO Box 92  
Guildford  
GU2 5TQ  
England

---

## DELAGUA WATER SURVEILLANCE AND MONITORING SUPPORT SERVICES

It is recognised that the cost of consumables for water testing in developing countries is often prohibitive. For this reason DelAgua is resolved to supply all necessary media, membrane filters, pads and spares at cost to any nominated port in the country of use of the water testing equipment. Consumables can be transported by ocean freight or air freight. Prices will be negotiated on bulk purchase in the UK and discounts passed on to the user. Typical current costs for faecal coliform analysis in Latin America by such transfers are less than 0.2 USD per sample.

Unfortunately, DelAgua is not in a position to arrange clearance from ports and customs, and does not have the resources to engage agents. Thus clearance must be arranged by purchasers. However, all goods will be insured against damage or loss in transit.

It is a condition of transaction that all equipment and support services including training be paid for in advance. DelAgua has no administrative support for invoicing in arrears.

Whilst every effort has been made to quote accurate costs DelAgua is not in a position to guarantee these costs for an indefinite period, but DelAgua does guarantee that all equipment and services will be supplied at cost and that costs will continue to be kept at absolute minimum.

DelAgua is a non-profitmaking organisation concerned with training consultancy in water treatment, water quality surveillance and sanitation in developing countries.

Registered Number 1860842

Registered Offices 128 High Street Guildford UK

GRUPO "A"

RECOMENDACIONES DE INVESTIGACIONES PARA EL FUTURO

El grupo reconoce que el equipo de generación de gases oxidantes MOGGOD, es una herramienta más para la desinfección del agua y que se puede elegir de acuerdo con las condiciones locales sin que esto necesariamente constituya la eliminación de otras alternativas ya en utilización.

Por tanto, se plantean las siguientes recomendaciones:

1. <sup>224</sup> La investigación en relación a especies de oxidantes, cantidades en que se producen, eficacia de su acción, formación de organo clorados y otros subproductos, que sea realizada por las instituciones cuya infraestructura es permitida, <sup>debe incluirse la universalidad.</sup> debiendo comunicar a los países y/o instituciones interesadas los resultados de esas investigaciones.
2. Interesar a <sup>AWWA</sup> ACU... y EPA en trabajos de investigación en áreas relacionadas con el MOGGOD y tratar de involucrar a los gobiernos de los diferentes países para financiamiento de las investigaciones.
3. La investigación de la operación (adaptabilidad, instalación, operación, insumos, costos, seguimiento) será ejecutada por los países participantes, debiendo establecerse un protocolo para la investigación y que los resultados sean compartidos estableciéndose un banco de datos al que los países participantes tengan acceso.
4. El protocolo de investigación deberá contemplar, entre otros aspectos, los siguientes:
  - 4.1 Análisis de la situación salud antes, durante y después del proceso de desinfección con el MOGGOD, →
  - 4.2 actitud de las comunidades ante las nuevas experiencias,
  - 4.3 acciones de motivación y educación sanitaria continuada, las cuales deberán aplicarse en las comunidades a beneficiar.
  - 4.4
5. - Desarrollo de tareas de investigación en materiales a emplear en electrodos, membranas y su disposición, y de las partes constitutivas a fin de aumentar su confiabilidad y eficiencia en la operación, así como el estudio de fuentes alternas de energía.

Se utilizará la retroinformación de los protocolos de investigación.

6. La OPS deberá interesar a los gobiernos, a través de los conductos correspondientes, para que se lleven a cabo las acciones recomendadas.

del  
GRUPO B  
227

7. Fomentar la investigación local para la producción y/o readecuación del equipo y sus componentes a fin de mantener en operación las unidades.

#### DESARROLLO Y EVALUACION DE PROYECTOS

1. El desarrollo de la investigación en su etapa inicial deberá realizarse en diferentes condiciones ambientales y/o geográficas e ir acompañada de una información epidemiológica consistente antes y después de la acción de desinfección con el MOGGOD.

Esta información epidemiológica servirá como base de sustentación para la implementación de futuros proyectos en áreas de similares características las que sólo necesitarán análisis microbiológicos y exámenes fisicoquímicos.

2. Replantear y/o continuar el desarrollo de la experiencia con el MOGGOD a fin de establecer o complementar la información técnica en forma acumulativa. En otro orden de ideas, ampliar la experiencia con la utilización de diferentes equipos. *1 de mayo #*
3. En todos los casos, establecer comparaciones técnicas y económicas entre MOGGOD y desinfección con técnicas tradicionales.
4. Las investigaciones deberán desarrollarse en un tiempo prudencial, dependiendo de las facilidades y condiciones locales.

#### COLABORACION HORIZONTAL E INTERNACIONAL

1. Toda la información que se necesite deberá ser canalizada a través de las Representaciones de la OPS/OMS en los diferentes países.
2. Aprovechar el recurso calificado que exista en las regiones como efecto multiplicador para la difusión de esta tecnología.

*Fuentes de financiación .*

*3.- debe organizarse financiación Conferencia .*

GRUPO "B"

RECOMENDACIONES Y FUTURAS INVESTIGACIONES

1. Objetivo del Seminario

- a. Presentación del equipo y avances realizados en cada país
- b. Intercambio de experiencias
- v. Desarrollo tecnológico

Comentario. En el presente seminario se pudieron apreciar los problemas de instalación de los equipos en cuanto a operación y parámetros básicos de control (oxidabilidad, análisis bacteriológico, demanda de cloro).

2. Recomendaciones

2.1 Específicas

- 2.1.1 Instalado el equipo, consideramos conveniente llevar a cabo las determinaciones básicas sobre:

*Análisis Fisicoquímicos.*

- demanda de cloro
- cloro residual
- análisis bacteriológicos: coliformes totales y coliformes fecales

Previa a estas determinaciones, se requiere llevar a cabo un estudio epidemiológico antes de la instalación de estos equipos de mezcla de gases oxidantes, estudios tales como incidencia de enfermedades gastrointestinales, desnutrición, etc.

- 2.1.2 Evaluar comparativamente con el equipo de gases oxidantes los otros equipos de desinfección que vienen funcionando.

2.2 Generales

- 2.2.1 Que a través del CEPIS <sup>de tener</sup> tener una red de información sobre el ~~funcionamiento~~ financiamiento del equipo de mezcla de gases oxidantes en los países participantes en el seminario.

- 2.2.2 Continuar con la investigación del equipo y monitoreo.

- 2.2.3 Recomendar a la industria para la investigación nacional sobre el perfeccionamiento del equipo de acuerdo a las necesidades y las condiciones propias de cada lugar (unidades de bacteria, sal común).

*que sea factible.*

- ✓ 2.2.4 Vincular a las universidades con el desarrollo de investigaciones básicas, tendientes a evaluar y desarrollar la aplicación de la tecnología.
- ✓ 2.2.5 Estimular la creación de pequeñas industrias o de capitales locales para la producción de estos equipos.
- ✓ 2.2.6 Incluir en la evaluación un mayor número de equipos para utilizarlos en diferentes comunidades.
- ✓ 2.2.7 Estudio epidemiológico para ver el impacto del sistema de desinfección en la comunidad, especialmente en la población infantil.
- ✓ 2.2.8 Recomendar el incentivo de la promoción y educación sanitaria, con la finalidad de propiciar la aceptación del equipo de mezcla de gases oxidantes en las comunidades o lugares a instalarse.
- ✓ 2.2.9 Se propone tener los <sup>primeros</sup> resultados de la evaluación y desarrollo de la investigación en el período de un año.

### ✓ 3. Fuentes de financiamiento

Para la evaluación y adquisición de equipos de gases oxidantes es necesario contar con la colaboración de las siguientes entidades:

- OPS/OMS
- UNDP
- BID
- AID
- GTZ
- CEPIS (asistencia técnica e intervención más activa)
- CIID
- CIR (Holanda) *Centro Internacional de Referencia.*
- Colaboración entre las entidades de salud, universidades

En el caso específico de cada país, ver la posibilidad de financiar la preparación de tesis sobre la evaluación del equipo de gases oxidantes por parte de los estudiantes.

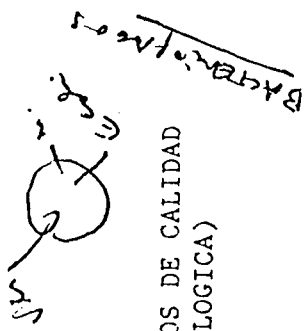
GRUPO "C"

RECOMENDACION DE FUTUROS PROYECTOS INMEDIATOS

- ✓ 1. Uniformización de formatos de captura de datos:
  - a. Control de operación
  - b. Control de calidad: bacteriológica y físicoquímica
- ✓ 2. Elaboración de manuales de operación y mantenimiento prácticos y accesibles (a nivel de las personas que manejarán el equipo).
- ✓ 3. Después de determinar la zona en donde se <sup>instalará</sup> aplicará el equipo, desarrollar un estudio de morbilidad de la población (por estatus de edades) para observar el impacto social-sanitario de utilizar un nuevo desinfectante.
- ✓ 4. Hacer un estudio para determinar el nivel de cloro residual necesario en tanque y/o red de distribución para obtener agua sanitariamente segura.
- ✓ 5. Efectuar un análisis comparativo (técnico-económico) de la utilización del equipo generador de gases oxidantes versus otros procesos de desinfección.
6. Desarrollar una tecnología práctica y a bajo costo para la purificación de la sal comercial.
7. Verificar la producción de gases oxidantes a diferentes condiciones de presión y temperatura.

RECOMENDACIONES A LARGO PLAZO

1. Investigación sobre la producción de electrolisis a partir de otro tipo de energía no convencional.
2. Investigación sobre el uso de diferentes electrodos (y su eficiencia) y membranas, con miras a reducir costos.
3. Estudio de la factibilidad de producción parcial o total del equipo MOGGOD a nivel nacional.
4. Continuación de la investigación concerniente a la caracterización de los gases generados con la finalidad de evaluar sus efectos sobre la salud.


  
 Bacteriología

FORMATO DE DATOS DE CALIDAD  
 (BACTERIOLOGICA)

Origen: POZO SANTA CLARA

Localización: Distrito Vitarte (Lima, Perú)

*Remando de bacterias fecales*

M.A. (Col/ml)	Colif. fecales (NMP/100 ml)	Agua influente	Parásitos
	Colif. totales (NMP/100 ml)	Virus (UFP/100 l)	

Fecha	Hora	Toma de muestra	Dosis de Amper. gases mezclad. ml	M.A. Col/100 ml	C. Fec. NMP/100 ml	C. Tot. NMP/100 ml	Virus UFP/100 ml	Parásitos	Cl2 libre resid. mg/l	Gases oxid. resid. mg/l	Otro resid. mg/l

OBSERVACIONES:

Nota: Procesar los datos calculando el % de remoción (o mortalidad) y compararlo con la norma regida para agua potable.

FORMATO DE DATOS DE CALIDAD  
(FISICOQUIMICA)

Origen: POZO SANTA CLARA

Localización: Distrito Vitarte (Lima, Perú)

T° °C	Cr mg/l	pH	Agua Influyente						
			Turbiedad U.T.	Color U.C.	As mg/l	Fe mg/l	Mn mg/l	Co3 mg/l	

---

Fecha Hora	Toma muest.	C.A. amp.	T° °C	Cr mg/l	pH	Turb. U.T.	Color U.C.	As mg/l	Fe mg/l	Mn mg/l	CO3 mg/l

---



---



---



---



---



---



---



---



---



---

OBSERVACIONES:

---



---



---



---



---





## UNIDAD DE PURIFICACION DE AGUA

### 1. DESCRIPCION DEL SISTEMA ELECTROLITICO

Los Alamos Technical Associates, Inc. (LATA) ha desarrollado un método electrolítico simple de bajo voltaje para la esterilización del agua potable, que se puede emplear en localidades remotas, países en vías de desarrollo y áreas de desastres naturales. El método sólo requiere de una solución de sal o agua de mar para producir una mezcla sinérgica de oxidantes directamente en solución. Un volumen de la corriente del ánodo mezclado con 500 a 1,000 volúmenes de agua contaminada extermina rápidamente los microorganismos y patógenos humanos resistentes, produciendo agua apta para el consumo humano y quedando un residual de cloro para impedir el crecimiento interior de los microorganismos durante el almacenaje y distribución. Los requerimientos energéticos son 12 V CC, 14A para una unidad capaz de producir 8,000 galones de agua tratada por hora.

La unidad prototipo de purificación electrolítica de agua es un módulo sencillo y resistente. Una unidad modular consta de una bomba, tubería, transformador CC, una celda electrolítica de 3 x 5 x 0.5 pulgadas, controles y un recipiente sellado para romper el vacío. Este módulo cabe en un estuche de fibra de vidrio intemperizado de 24 x 24 x 12 pulgadas. La unidad pesa aproximadamente 23 kg, principalmente en razón del transformador y el estuche de fibra de vidrio.

Para operar la unidad se requiere de una fuente de energía externa, como por ejemplo una batería de automóvil (batería de almacenamiento de 12 V) o panel solar (14-45 W), y una solución de alimentación de salmuera diluida, 0.75 M NaCl. Cuando la salmuera diluida entra en contacto con las superficies catalíticas de metales Grupo VIII de la celda electrolítica, se produce en el ánodo una mezcla de oxidantes que incluye cloro libre, hipoclorito, radicales libres de cloro y oxígeno y ozono. Esta corriente de efluente del ánodo se utiliza para tratar el agua contaminada. La corriente de efluente del cátodo se elimina.

Cuando la corriente del ánodo se mezcla con 500 a 1,000 volúmenes de agua contaminada, los oxidantes de corta vida matan a los microorganismos, destruyen los componentes orgánicos como fenoles, precipitan metales pesados como óxidos y mejoran el color, olor y sabor del agua. El cloro proporciona un residuo de larga duración para impedir que vuelvan a crecer las bacterias y permite verificar el tratamiento de agua mediante pruebas patrón de concentración de cloro. La Figura 1 presenta un diagrama del proceso.

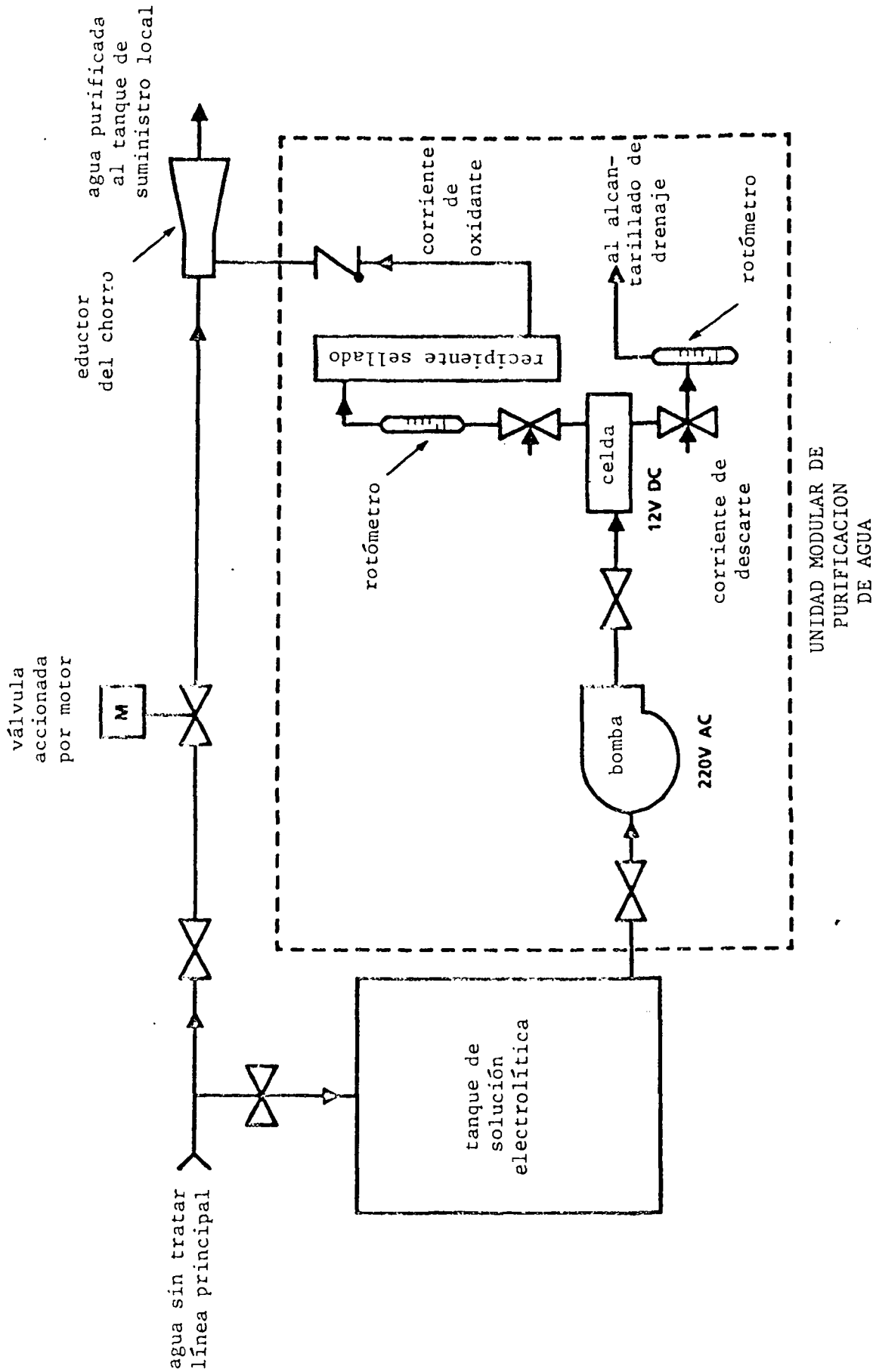


Figura 1. Diseño esquemático de la unidad LATA de purificación de agua.

## 2. POSIBLES APLICACIONES

Esta unidad simple, pequeña y resistente de tratamiento de agua puede utilizarse en muchas localidades ya que no necesita de una red de suministro eléctrico desarrollada, personal de mantenimiento capacitado, suministros químicos peligrosos o importados, ni tampoco de un apoyo industrial adyacente. Entre sus posibles aplicaciones podemos mencionar:

- Localidad permanente remota,
- grupos de exploración móvil,
- operaciones de rescate en desastres naturales,
- unidades militares,
- instalaciones de embarcaciones marítimas, y
- como algicida en sistemas de agua refrigerante.

El tamaño de la unidad puede adecuarse a la aplicación deseada, pudiendo colocarse varios módulos en serie para aumentar el volumen de agua tratada. Las unidades pueden sacarse individualmente de la línea para su mantenimiento, sin afectar la producción. El método es 100% efectivo contra E. coli, Legionella pneumophilia, Pseudomonas aeruginosa, quistes de Giardia y esporas de Bacillus subtilis.

## 3. PUNTO DE CONTACTO

Para mayor información relacionada a este método exclusivo de tratamiento de agua dirigirse a:

Los Alamos Technical Associates, Inc.  
P.O. Box 410  
1650 Trinity Drive  
Los Alamos, New Mexico 87544  
E.U.A.

Atención: H.F. Gram  
Teléfono: (505) 662-9080

PRIMER SEMINARIO INTERNACIONAL SOBRE DESINFECCION  
DEL AGUA POR OXIDANTES MEZCLADOS  
MINISTERIO DE SALUD  
REPUBLICA DE PANAMA

Ing. Francisco Osorio

I.- DESCRIPCION DEL PROGRAMA:

El Ministerio de Salud a través de la Dirección Nacional de Ingeniería Sanitaria y Conservación es el responsable de dotar de agua potable a la población rural de menos de 500 habitantes mediante sistemas de acueductos o pozos públicos accionados con bombas manuales. Las comunidades rurales de mayor población y el área urbana, son abastecidas por el Instituto de Acueductos y Alcantarillados Nacionales (IDAAN).

El programa de acueductos rurales del Ministerio contempla que una vez construido el acueducto la comunidad beneficiada sea la responsable de administrar, operar y mantener el sistema, limitandose el Ministerio de Salud a las responsabilidades de supervisión y apoyo técnico requerido por la comunidad. Este mecanismo de trabajo se ha desarrollado con bastante éxito en la República de Panamá y debido a este se han podido construir más de 1000 sistemas de acueductos rurales en todo el país, abasteciendo a más de 340.000 habitantes del área rural con conexión domiciliaria.

De los 1000 sistemas construidos aproximadamente el 90% utilizan agua subterránea como fuente de abastecimiento, mediante pozos profundos o manantiales captados en su nacimiento. El 10% restante utiliza agua superficial que en la mayoría de los casos es tratada a través de filtración len

ta antes de ser distribuida.

Menos del 5% de los sistemas en operación son clorados actualmente y los análisis de agua se hacen en forma puntual sin obedecer a un verdadero programa de control de calidad del agua abastecida.

## II.- EXPERIENCIA CON EL EQUIPO MOGGOD

La OPS/OMS ha donado a la República de Panamá (8) equipos MOGGOD completos con su correspondiente sal TNAS. Este equipo fué distribuido en la siguiente forma:

- (4) equipos para ser instalados por el IDAAN
- (4) equipos para ser instalados por el Ministerio de Salud

El Ministerio de Salud instaló el 18 de noviembre de 1987 el primer generador de gases oxidantes con una capacidad de 1/2 libra de oxidantes por día en la comunidad de Loma Bonita, Provincia de Panamá. Esta comunidad se dedica más que nada a la ganadería y la agricultura y por su cercanía a la ciudad de Panamá, parte de su población trabaja en la misma.

### 1.- Características Principales del sistema de acueducto:

Número de conexiones	= 65
Población servida	= 330 habitantes
Fuente de Abasto	= Pozo profundo con forro de 6"Ø
Caudal de bombeo	= 45 gal/min. (2.85 l/s)
Capacidad de almacenamiento	= 4500 galones (17.0 m <sup>3</sup> )
Equipo instalado	= bomba sumergible de 2 H.P.
Red de distribución	= 1 km de radio aproximadamente en 2"Ø PVC

### 2.- Instalación del equipo:

El equipo fué instalado siguiendo las indicaciones que aparecen en el manual suministrado, se utilizó una válvula de paso para crear una

presión diferencial y regula el vacío producido por el venturi.

Hasta la fecha no se ha podido instalar un medidor de gases que permita conocer la cantidad de oxidantes producidos.

La instalación eléctrica se hizo de manera que el generador de oxidantes sea controlado con la cajilla de la bomba y sus controles de niveles.

No hubo problemas técnicos en la instalación de este equipo.

3.- Calidad del agua cruda:

El agua cruda es de buena calidad, ya que los análisis no presentaron bacterias coliformes, con una demanda de cloro de 0.5 mg/l a una temperatura de 25°C.

4.- Funcionamiento del Equipo:

La operación del equipo se inició a diferentes amperajes para obtener el que se ajustase más a la producción diaria de agua, obteniéndose un amperaje óptimo de 5 amp. para mantener un cloro residual de salida de 0.8 a 1.0 mg/l. Con esta producción de gases se obtuvo en la red un cloro residual de 0.6 mg/l en las casas más céntricas a 0.3 en las viviendas más alejadas.

5.- Ventajas observadas de la desinfección con el equipo MOGGOD:

- Fácil instalación
- Fácil operación para el personal con poco adiestramiento encargado de operar los acueductos rurales.
- Mejor control en la dosificación para obtener un cloro residual deseado, comparado con el clorinador por goteo.

- El equipo de 1/2 libra diaria se ajusta a las demandas diarias de agua de las poblaciones y a la calidad del agua abastecida por el Programa de Acueductos Rurales.

( - Desventajas:

Debido al poco tiempo que tiene el equipo MOGGOD de estar instalado y a la poca información disponible sobre el mismo se desconoce lo siguiente:

- Principales problemas de mantenimiento y reparación de los mismos.
- Disponibilidad y costo de repuestos, sobre todo la membrana semipermeable y los electrodos.
- Experiencias obtenidas trabajando con corriente directa.

-- Asuntos importantes de instalación del MOGGOD:

Se ha querido resaltar el hecho de que debido a que la producción del pozo disminuye en la estación seca y la bomba es controlada automáticamente por el control de niveles, se decidió que el equipo MOGGOD fuese controlado igualmente en forma automática por este control, para evitar que siguiese produciendo gases en el intervalo de parada del equipo que dura aproximadamente 10 minutos. Sin embargo, esto produce una entrada de corriente instantánea al transformador que se desconoce el efecto que pueda tener en el mismo a largo plazo.



\*\*\* DESINFECCION, UTILIZANDO EL MOGGO \*\*\*

Esta unidad de desinfección fue instalada primeramente en un pozo con un gasto de 25 L.p.s., siendo muy elevado para la capacidad de la unidad oxi que se instaló, esto se manifestó en el residual de cloro máximo que se alcanzó en la red, el cual fue de 0.1 ppm.; aún con esto, se lograron buenos resultados, tal y como se muestran en el Cuadro No. 1 los análisis bacteriológicos del agua, antes y después de tratamiento a las 12 hrs. de funcionamiento. Por otra parte, en este lugar se tuvo problemas de taponamiento de la membrana y su funcionamiento era de unas 20 hrs., aproximadamente.

El Moggo se cambió a otro lugar, donde se tiene problemas de contaminación, este pozo tiene un gasto de 12 L.p.s. y 240 Coliformes Totales/100 Ml., en este lugar se presentaron problemas para la desinfección, ya que la zona es alimentada por dos pozos, y, el agua tratada llega a una pequeña zona, encontrándose en estos lugares, residuales de cloro libre de 0.2 p.p.m. y 0 de coliformes Totales/100 Ml., los resultados se indican en el Cuadro No. 2. En esta parte el equipo duró en funcionamiento nueve días, se quitó para darle mantenimiento por presentar fuga.

Actualmente se encuentra instalado en una pequeña comunidad, con un gasto de 2.7 L.p.s., 632 Coliformes Totales/100 Ml. y 1 Coliforme Fecal/100 Ml.; para óptimo funcionamiento del equipo, se instaló una bomba de ayuda para vencer la presión y, como el Venturi es muy frágil, éste fue sustituido por el inyector de un equipo clorador, con lo cual se ha tenido buen funcionamiento.

\*\* RESULTADOS DE ANALISIS BACTERIOLOGICOS \*\*

(LAS MUESTRAS FUERON TOMADAS EN LOS MISMOS LUGARES ANTES Y DESPUES)

ZONA	AGUA CRUDA		AGUA TRATADA	
	CLORO RESIDUAL	COLIFORMES/100 ML. TOTALES	CLORO RESIDUAL	COLIFORMES/100 ML. TOTALES
1	0.0	28	0.1	0
	0.0	40	0.1	0
	0.0	78	0.1	0
	0.0	30	0.1	0
	0.0	10	0.1	0
	0.0	18	0.1	0
2	0.0	630	0.0	71
	0.0	1150	0.0	20
	0.0	1187	0.0	30
	0.0	712	0.0	80
	0.0	118	0.2	0
3	0.0	640	0.2	0
	0.0	760	0.2	0
	0.0	710	0.2	0
	0.0	820	0.5	0
	0.0	750	2.0	0
	0.0	720	0.3	0
	0.0	670	0.3	0
	0.0	690	0.3	0
0.0	670	0.3	0	

DESINFECCION DEL AGUA MEDIANTE EL MOGGO :

La unidad oxi 2 lb. de capacidad es probada en la salida de un tanque de almacenamiento con un gasto de 17 -- l.p.s., ésta agua tiene una concentración bacteriana -- de 86 coliformes totales/ 100 MI y 0 de coliformes ---- fecales/100 MI.

Este tanque abastece a una población de 12,000 habitantes.

Se encontró que el agua con un residual de cloro libre' de 0.2 PPM a la salida del tanque llega hasta el punto' más alejado de la red de distribución sin cloro resi--- dual, teniendo una eliminación bacteriana del 98 % .

\*\* RESULTADOS DE ANALISIS BACTERIOLOGICOS \*\*

ZONA	AGUA CRUDA		AGUA TRATADA			
	CLORO RESIDUAL	COLIFORMES/100 ML.		COLIFORMES 100/ML. FECALES		
		TOTALES	FECALES		TOTALES	
1	0.0	91	0	0	0.3	0
	0.0	221	0	0	0.2	0
	0.0	129	0	0	0.2	0
	0.0	59	0	0	0.3	0
	0.0	65	0	0	0.3	0
	0.0	150	0	0	0.1	0
	0.0	140	0	0	0.2	0
2	0.0	150	0	0	0.4	0
	0.0	650	0	0	0.0	12
	0.0	650	0	0	0.0	11
	0.0	260	0	0	0.1	0
	0.0	240	0	0	0.2	0
3	0.0	235	0	0	0.1	0
	0.0	90	0	0	0.5	0
	0.0	100	0	0	0.2	0
	0.0	130	0	0	0.2	0
	0.0	120	0	0	0.2	0
	0.0	135	0	0	0.3	0

ZONA 1 LOMAS DEL MARQUES 2,000 HAB.  
 ZONA 2 RANCHO SAN ANTONIO 8,000 "  
 ZONA 3 BOLAÑOS 2,000 "

# PROGRAMA DE VIGILANCIA Y MEJORAMIENTO DE CALIDAD DE AGUA

## FORMULARIO DE INSPECCIONES RURALES SISTEMAS DE GRAVEDAD SIN TRATAMIENTO

Guía Hoja 1

Comunidad..... Fecha ...../...../.....

### GUIA PARA EL LLENADO DEL FORMULARIO

1. PLANIFICAR para hacer por lo menos:
  - una visita por año a cada comunidad
  - y una visita adicional por año, por cada una de las siguientes condiciones:
    - cuenta con un sistema de bombeo
    - cuenta con una planta de tratamiento
    - tiene un población servida de más de 500 hab.
2. NOTIFIQUE a la comunidad de su visita con anticipación  
NUNCA hacer más que un inspección por día
3. HAGA su inspección y COMPLETE el formulario en presencia de un representante del pueblo (autoridad de agua). El( los) debe(n) firmar abajo.
4. LLENAR el formulario con letra de imprenta
5. CONTESTE todo el formulario.
  - para contestar sí, marque así: sí ( x ), no ( )
  - para contestar no, marque así: sí ( ), no ( x )
  - cuando haya varias posibilidades, marque la apropiada ( x )
  - para números, nunca marque ( - ) ó ( x ), siempre coloque 0 ó el valor correspondiente.

USE los espacios de "Observaciones" y "Esquema Sencillo" para clarificar o poner otra información de importancia

6. Al día siguiente- complete una copia del formulario para enviar a la BRD-Región Central a fin de mes ( a máquina)
  - complete dos formularios de informe al pueblo ( a máquina) y ENVIELOS ( una copia a la BRD\* y una copia al pueblo)(\*BRD = Base Regional de DITESA)

### Determinación de la Potencia de Cloro en Polvo

1. Tome una muestra de unos gramos en una bolsa plástica y guárdelos en un lugar oscuro, frío y seco hasta el momento del análisis. Siempre haga el análisis antes de las 48 horas.
2. Mida 1g del polvo con la balanza de precisión.
3. Disuélvalo en 1 litro de agua limpia (destilada si es posible).
3. Tome 5 ml de la solución en una pipeta y échelo en 1 litro de agua, mezcle bien.
4. Chequee la concentración de cloro total en el agua con el comparador (= x) mg/l
5. Potencia ( %) = concentración ( x ) x 200

**PROGRAMA DE VIGILANCIA Y MEJORAMIENTO DE CALIDAD DE AGUA**

*Hoja GST-1*

**Comunidad**..... **Fecha** ..... / ..... / .....

**INSPECCION**

Fecha de Inspección ..... / ..... / .....

Inspección hecha por 1.....

2.....

Del PVMCA-.....(base)

**LUGAR**

**Código**.....

Comunidad.....

Distrito.....

Provincia.....

Departamento.....

Nombre del Barrio del pueblo	con servicio de agua	población total	No. Usuarios/población servida
.....	sí ( ), no ( )	.....habs	.....habs
.....	sí ( ), no ( )	.....habs	.....habs
.....	si ( ), no ( )	.....habs	.....habs
.....	sí ( ), no ( )	.....habs	.....habs
.....	si ( ), no ( )	.....habs	.....habs
<b>TOTALES</b>		.....habs	.....habs

**GENERALIDADES**

Numero de horas de viaje desde la base del PVMCA a la comunidad=..... horas

distancia=..... Km

por: carro ( ), tren ( ), moto ( ), caballo ( ), otro=.....

Ministerio de Salud: Puesto ( ), Centro ( ), Botiquín Comunal ( ), otro=.....

qué distancia del centro del pueblo .....Km, ..... horas de viaje

Médico ( ), Enfermera ( ), Sanitario ( ), Promotor ( ), otro = .....

Hay una escuela en la comunidad? sí ( ), no ( )

Hay luz en la comunidad? sí ( ), no ( )

**FIRMAS**

Firmas de los Inspectores del Equipo de Vigilancia:-

1..... 2.....

NOMBRE..... NOMBRE.....

CARGO..... CARGO.....

Firmas de los representantes del pueblo

1..... 2.....

NOMBRE..... NOMBRE.....

CARGO..... CARGO.....

PROGRAMA DE VIGILANCIA Y MEJORAMIENTO DE CALIDAD DE AGUA

Hoja 65T-3

Comunidad..... Fecha ...../...../.....

FUENTE DE AGUA

Tipo de fuente: manantial captado directo ( ), lago/laguna ( ), pozo ( ), río ( ), riachuelo ( ), quebrada ( ), canal de riego ( ), otro = .....

Nombre de la fuente.....

Contaminación de la fuente de agua: minería ( ), letrinas ( ), basura ( ), ganado ( ), lavandería ( ), animales ( ), humanos ( ), otros = .....

Cantidad de agua existente en la fuente = ..... litros por segundo (Ver Hoja 2) es la cantidad usual (todo el día y todo el año): sí ( ), no ( ). (si no, EXPLIQUE en Observaciones)

a veces, no hay agua: sí ( ), no ( ) -cuántos días al año..... Cuándo..... -cuántas horas al día..... Cuándo.....

Se utiliza para irrigación: sí ( ), no ( )

La fuente está ubicada en terrenos de .....

Observaciones.....

CAPTACION

Manantial captado en directo y protegido sí ( ), no ( )

Está sellado? sí ( ), no ( ), o tiene tapa removible: sí ( ), no ( )

Está seguro (bajo llave)? sí ( ), no ( )

- con aletas: sí ( ), no ( ) -con sello (losa) de protección atrás: sí ( ), no ( ) -con tapa sanitaria: sí ( ), no ( ) -la protección es efectiva: sí ( ), no ( ); (si no, EXPLIQUE en Observaciones) -con cerco o muro: sí ( ), no ( ) que puede evitar el ingreso de animales: sí ( ), no ( ) -con canaletas de desvío para aguas superficiales: sí ( ), no ( ) -cuántos metros de la captación ..... metros -que puede prevenir el ingreso de las aguas: sí ( ), no ( )

Cantidad de agua que ingresa al sistema = ..... litros por segundo

Punto de aforo = .....

Existe control de flujo: sí ( ), no ( )

- por vertedero triangular: sí ( ), no ( ) de .....° (ángulo) -por vertedero rectangular: sí ( ), no ( ) -de qué materiales.....

Existe un medio para evacuar el exceso de flujo: sí ( ), no ( )

- por tubería de rebose vertical ( ) de ..... pulgadas de diámetro -u horizontal ( ) de ..... pulgadas de diámetro -o aliviadero ( ) de ..... centímetros de largo -se puede evacuar el 100% del ingreso: sí ( ), no ( )

Existe una tubería removible para limpieza: sí ( ), no ( ) o válvula de purga: sí ( ), no ( )

A la salida: -existe una canastilla: sí ( ), no ( ) o malla de protección: sí ( ), no ( ) -existe una válvula de control de salida ( )

Observaciones.....

Acciones Requeridas.....

PROGRAMA DE VIGILANCIA Y MEJORAMIENTO DE CALIDAD DE AGUA

Hoja GST-5

Comunidad..... Fecha ...../...../.....

RESERVORIO

Caja de válvulas:

Está sellada: sí ( ), no ( ) o tiene tapa: sí ( ), no ( ); seguro bajo llave sí ( ), no ( )
hay problemas con las válvulas: sí ( ), no ( ) (ESPECIFICARLOS en Observaciones)
puede evacuarse, agua de la caja de válvulas: sí ( ), no ( ). {por un hueco al fondo ( ) o por fondo de grava ( ) o por otro ruta=.....}
tiene rebose sí ( ), no ( ); tiene válvula de limpieza sí ( ), no ( )

Boca de inspección:

Existe: sí ( ), no ( ); protegida por tapa sanitaria: sí ( ), no ( )
Está sellada con concreto: sí ( ), no ( ), o seguro bajo llave: sí ( ), no ( )

El Tanque

Tiene ventilador(es): sí ( ), no ( ); con boca hacia abajo: sí ( ), no ( ) y protegido por malla: sí ( ), no ( )
Puede entrar el agua de lluvia: sí ( ), no ( ) o de la superficie: sí ( ); no ( )
Tiene fugas (el tanque): sí ( ), no ( )
Dimensiones Interiores: Largo=.....m, ancho=.....m, diámetro=.....m, altura de piso a rebose =.....m, Volumen = .....m³

Observaciones.....

Acciones Requeridas.....

LINEA DE ADUCCION (Longitud del Reservoirio al Pueblo)

Longitud aproximada = .....Km
Diámetro = .....pulgadas
Material: PVC ( ), FcOo ( ), Eternit ( ), otro = .....
Hay fugas: sí ( ), no ( ); cuántas.. .....(ANOTARLAS en el esquema sencillo)
Otros problemas: sí ( ), no ( ); cuáles.....(ANOTARLOS también)
Cuenta con caja(s) rompe presión: sí ( ), no ( ); cuántas .....(ANOTARLAS)
-cuenta con tapa sanitaria: sí ( ), no ( )
-cuenta con rebose: sí ( ) no ( ):
-por tubo ( ) o aliviadero ( ); adecuado para evacuar todo el rebose: sí ( ), no ( )
-protgido (p.e. por malla) contra el ingreso de cuerpos extraños: sí ( ), no ( )
-se saca agua de la(s) caja(s): sí ( ), no ( ):
-para consumo humano ( ) o para animales ( ) o para irrigación ( )
Cuenta con válvula de aire: sí ( ), no ( ) Cuántas.....(ANOTARLAS en el esquema)
Cuenta con válvula de purga: sí ( ), no ( ), cuántas .....(ANOTARLAS en el esquema)
Observaciones (ANOTAR si los componentes no funcionan).....

Acciones Requeridas.....







