

4846
36

213.2
4846

***CASE STUDY AND TECHNICAL
MANUAL TO A RAIN WATER
CATCHMENT TANK PROJECT***

213.2-4846

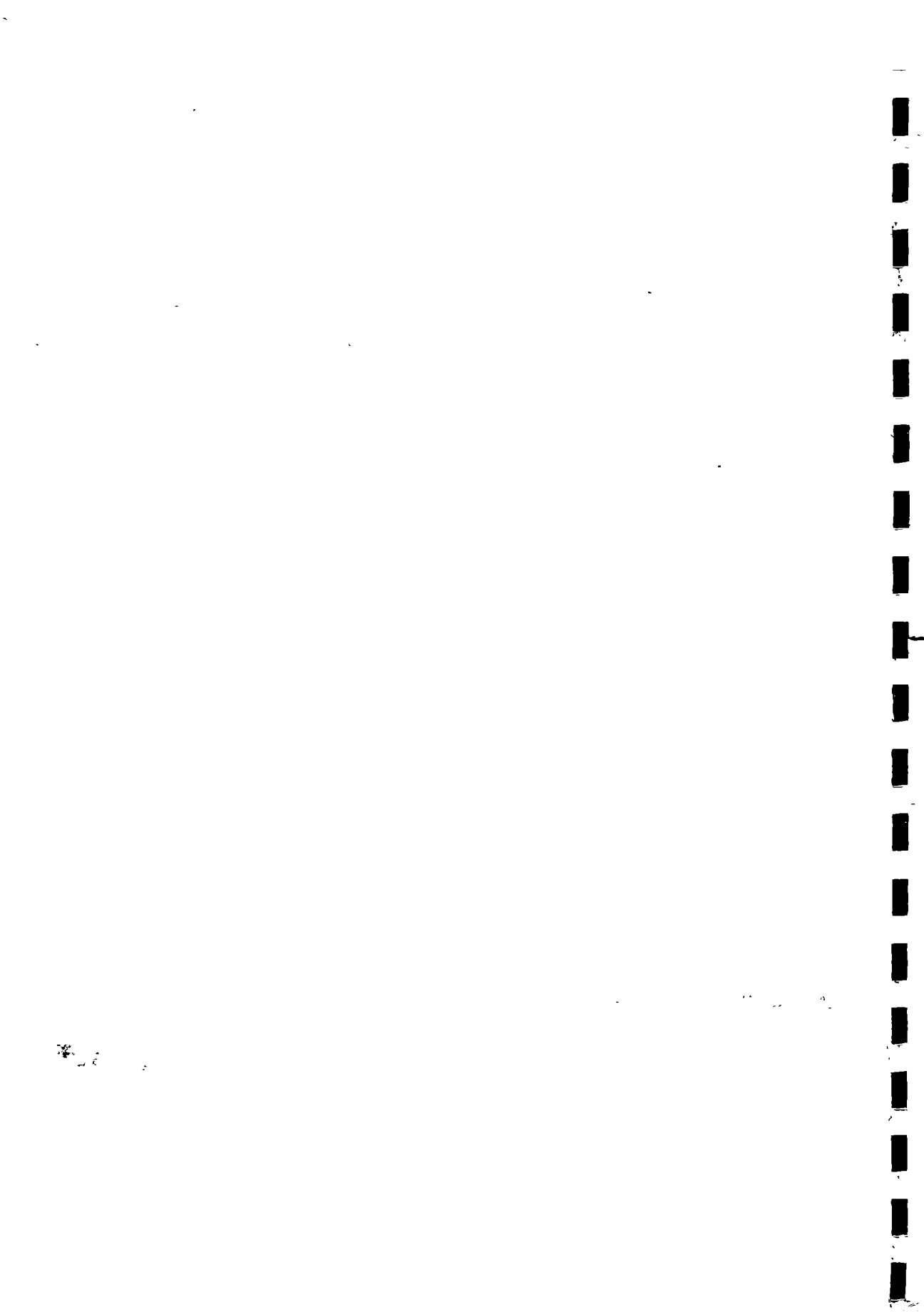

Heynen / Private

FROM FERRO TO BAMBOO

*a case study and technical manual
to Yayasan Dian Desa's rain water
catchment tank project*

MARCUS KAUFMAN

LIBRARY, INTERNATIONAL REFERENCE	
CENTRE FOR RAINWATER SUPPLY	
AND ...	
P.O. ... The Hague	
Tel (070) ... ext. 141, 142	
RN: 4846	ISBN = 4846
LD: 213 2	83FR



Yayasan Dian Desa is a private, Appropriate Technology Development Foundation located in Central Java, the Republic of Indonesia. This case study and technical manual of the Foundation's rain water catchment tank project was produced with the support and co-operation of The Asia Foundation, a U.S. based, non-profit organization. The Swiss Center for Appropriate Technology at ILE also provided valuable assistance. Reproduction of any or all parts of this publication is absolutely okey.

Marcus Kaufman

1983 Yayasan Dian Desa

Post Office Box 19 Bulaksumur

Yogyakarta, Indonesia

All rights reserved

Research assistance : Christine Arisanti

Cover design and layout : Marcus Kaufman

Original artwork : Haryoto

Technical assistance : Edwin Soedjarwo

Cows? If we had enough water around here to raise cows, I'd grow two crops of corn instead.

- Gunung Kidul Farmer

LIBRARY
INTERNATIONAL REFERENCE CENTRE
FOR COMMUNITY WATER SUPPLY AND
SANITATION (IRC)

SPECIAL THANKS TO UNICEF AND THE INDONESIAN DEPARTMENT OF HEALTH FOR THEIR SPONSORSHIP OF THE DIAN DESA PUBLICATION PENAMPUNG AIR HUJAN BAMBU SEMEN FROM WHICH MUCH OF THE TECHNICAL INFORMATION FOUND IN THIS BOOK HAS BEEN DRAWN.



Yayasan Dian Desa

Yayasan Dian Desa (YDD) is a private, non-profit foundation which, for more than ten years, has been conducting its own breed of development activities in rural communities throughout Indonesia. Project activities cover a wide range, from improved farming and food processing techniques, to social research and the publication of various technical manuals and reports. YDD's principal work however, has traditionally been in village water supply, and it is in this capacity that YDD has had its most far-reaching effect on the communities in which they work.

The Foundation's history goes back to 1969 when Anton Soedjarwo (YDD's founder and present Director) and four students

from Gadjah Mada's engineering school, conducted some "hands-on" volunteer work on the slopes of Java's Mount Merapi. This single project, a gravity supply water system serving just one village, grew and grew, and eventually led to the birth some years later, of Yayasan Dian Desa itself.



Anton Soedjarwo (left) in 1975: still on the slope of Java's Mount Merapi

Water

While considerable progress has been made in Indonesia since 1969, millions of families in rural areas still suffer from a perennial scarcity of clean drinking water. In many regions this is due to recurrent drought or simply chronically low rainfall. But other factors, such as deforestation, pollution and extreme population pressures, have also contributed to compound-

ing the seriousness of Indonesia's water supply problem.

It should be no surprise that water, the most basic of human needs, is a matter of primary concern to rural villagers and to the Government and non-government groups active in village development work in Indonesia. Organizations such as OXFAM, UNICEF, and CARE for example, receive countless requests for assistance with water supply projects (YDD like several other Indonesian foundations, conducts a considerable percentage of its village based projects with funds from such international organizations). The Indonesian Government also spends a respectable portion of its development money on both drinking water and irrigation projects.

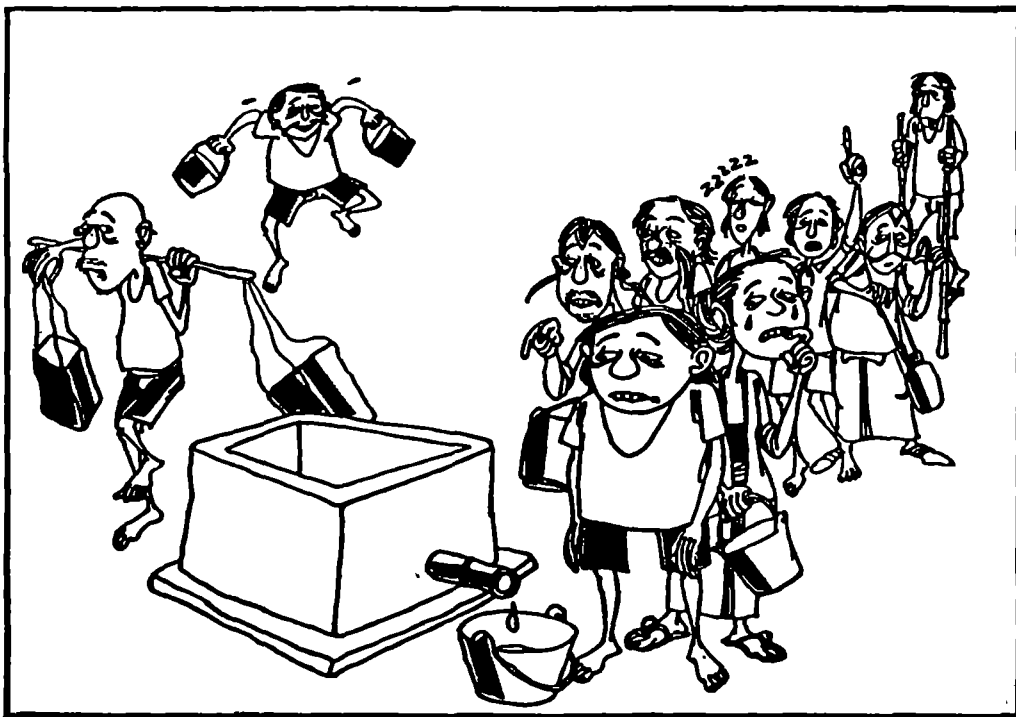

Water... a matter of primary concern

Appropriate Technology

YDD describes itself as an "Appropriate Technology Group" and as such always attempts to design village water supply systems which utilize simple, low-cost technologies. These projects, to a large extent, depend on local skills and resources, and on the active participation of local community members in all stages of work. YDD points to this "self-help" aspect of their work as one of the main reasons they have been successful in so many of their community development programs which begin with water supply.



Pre-project meeting with local residents: entering the mainstream

YDD's Director, Anton Soedjarwo describes their approach: "Instead of just 'dropping' a foreign piece of technology in a village setting, and then going on our way, we take a more careful, sympathetic approach. Our field workers live in a village for some time before any 'hard-ware' work takes place; and through surveys and discussions with the local people they attempt to determine what types of technological changes are feasible and appropriate for each particular village. In this manner, we hope to achieve a state of 'village development' which is more meaningful and lasting than a mere piece of equipment can ever be. Our normal strategy is to work through key, local individuals on what we call 'social overhead' projects (such as water supply) to address needs most crucial to local villagers; needs which perhaps are preventing them from ever progressing to a point where they can enter into the mainstream of Indonesia's 'Development Economy.' Our next step is to work on secondary projects (again through the same key, local people) to raise incomes and local standards of living. Our experience has shown that this strategy is a viable approach for a wide variety of community development problems."

Ferro Cement

In 1978, YDD began experimenting with what, for them was a completely new technology: ferro-cement. Ferro-cement is a peculiar construction technique consisting of a reinforced framework of iron rod (rebar) and chicken wire plastered internally and externally with a thin layer of Portland cement. Ferro-cement has for years been successfully used for boats, jars, walls and roofs; but YDD's goal was to design a ferro-cement

water tank which could be used for rain water catchment in villages where rain represents the only feasibly exploitable water resource.

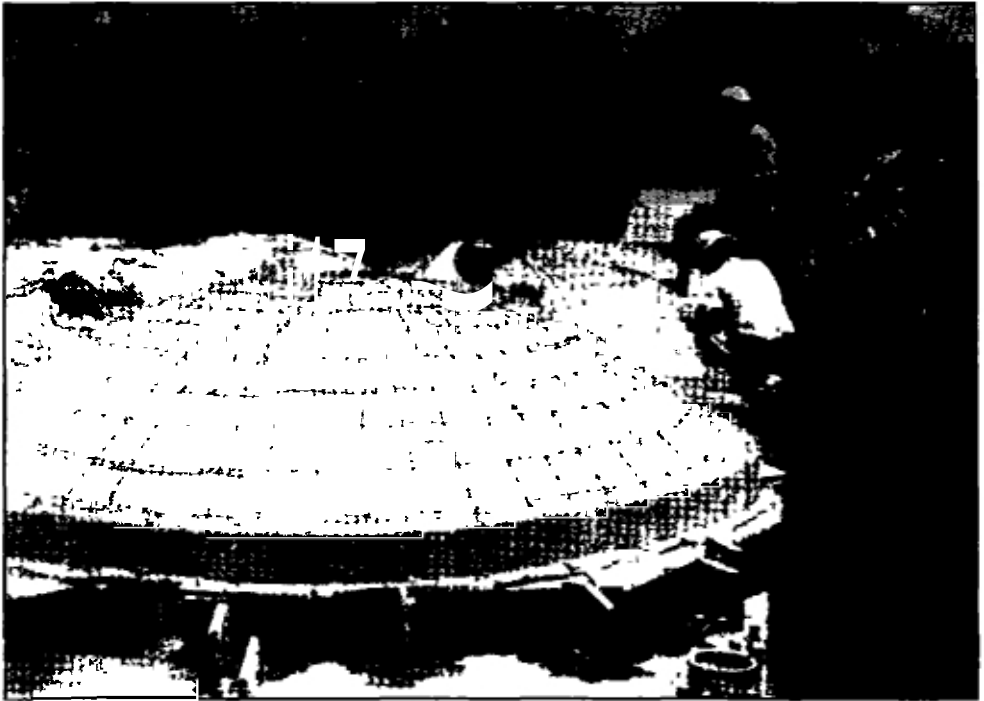

Ferro-cement roof atop Dian Desa's Yogyakarta center: isolated experiments

In 1978, after a number of isolated experiments, YDD finalized a preliminary design for a $10M^3$ "two family" tank. The tank was looked upon as having great potential. The construction process was such that it could easily be mastered by the ever-clever Indonesian villagers. The tank was, as well, priced considerably below other available alternatives (masonry, steel, fiberglass); and its small size was felt to be much more appropriate, especially in terms of maintenance, than larger, communal water tanks. With this new technology in hand, YDD's water supply staff were ready for some trial, village-based work.

Gunung Kidul

The dry range of mountains southeast of Yogyakarta, known as Gunung Kidul (the Southern Mountain) is a particularly critical area in every sense of the word. The land is largely deforested, good soil is extremely scarce, and ground water virtually non-existent (porous limestone covers most of the region to a considerable depth). Local residents draw their water from drainage ponds and subterranean caves and often have to walk many kilometers to do so. Very few other sources of water exist and in the dry season (which often lasts as long as six months) water becomes as scarce as money, in most of Gunung Kidul.

It was in this context that YDD first introduced the ferrocement rain water catchment tank on a trail "pilot project" ba-



Kids and goats in Gunung Kidul

sis. Together with a select team of local "cadre", they built first 20, then 60, then 100 tanks in a small hamlet called Sidorejo.

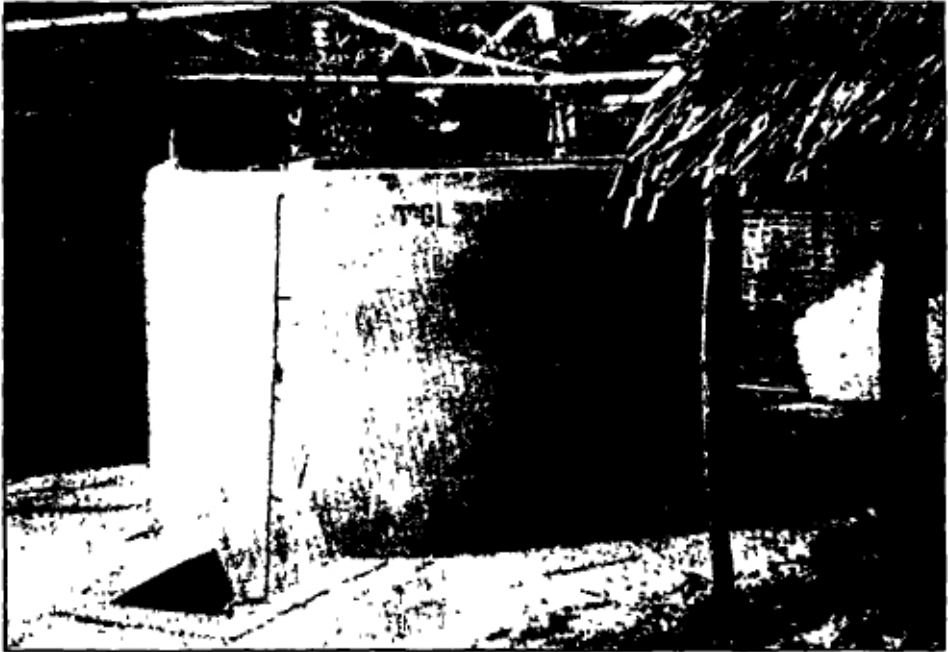

An early ferro-cement rain water catchment tank

In an early progress report, YDD's principal field worker described the basic principles behind the project:

- (1) The project must be implemented such that local community members fully participate in all stages of work. In this manner, technical skills as well as confidence and self-esteem will be developed.
- (2) The project must be designed such that dependence on outside products and materials is kept to a minimum.
- (3) Local lifestyles and traditions must be considered in planning all tank locations.

(4) Project work schedules must be matched with local time constraints.

(5) The transfer of technical skills and maintenance know-how must be considered a primary goal of the project.

(6) Local opinions regarding water consumption and water use patterns must always be taken into consideration.

The tanks were originally intended to serve as a water resource of "last resort"; meaning that villagers would continue to use existing local sources for as long into the dry season as they could - and turn to the tanks only when these other resources were completely exhausted. In this manner, a safe supply of water could be held in reserve, to be used during those two to three months of the dry season when fresh water was completely unavailable. The planned follow-up activity for each tank project was most often the introduction of a new crop (winged bean) or food processing technology (cassava dryers).

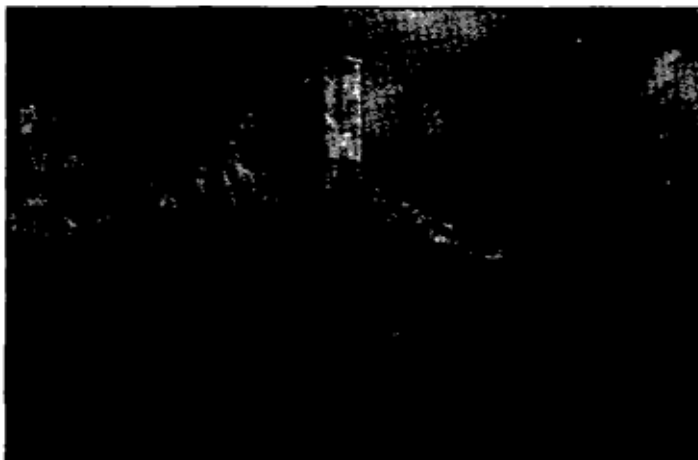

Improved cassava dryers: a follow-up activity

YDD conducted other catchment tank projects in 1978, in villages throughout Gunung Kidul - using their original ferro-cement tank design and following a project plan similar to the one used in Sidorejo. Local village cadre continued to play a large role in the implementation of the projects and the quantity of tanks constructed soon began to be numbered in the hundreds. However, feedback regarding the appropriateness of the original tank design soon required that several changes be considered. A better, more efficient means of constructing the rebar frame was needed, as was a more permanent and effective tank filter and lid. Early in 1979, YDD designed a new ferro-cement



Bending rebar

tank which incorporated these two changes as well as several others. The new tank however, did not even begin to address a number of other criticisms which were being voiced about the ferro-cement technology; most basic of which concerned the cost and



Plaster: the final ingredient

availability of the essential raw materials - rebar, chicken wire, cement and sand.

Considering the economic means and standard of living of a typical Indonesian farm family, it is easy to understand the financial problems posed by the ferro-cement tank technology. In short, an individual farmer would be hard pressed to purchase on his own, the materials needed for a ferro-cement tank. While ferro-cement is certainly less expensive than many other types of tanks, its cost is still beyond the means of all but the most wealthy villagers. This fact alone, greatly limited the extent to which the tanks could ever be financed and built by villagers themselves without the assistance of YDD or some other outside agency. Thus, the extent to which the tanks would be spread with purely local initiative was limited, and several of YDD's own principles were, therefore, not being met in the project. The

technology was *not* easily reproducible (given its prohibitively expensive cost); and as virtually all raw materials had to be procured outside the village, villagers were forced into an undesirable dependency on imported goods.

It is at moments like these that YDD's "careful, sympathetic approach" to village development pays off: many of the villagers involved in the project had already developed a strong sense of pride in their ability to build tanks and thus participate in solving a common local problem. These cadre were by no means mere "coolies" on the job - rather they were the daily managers and engineers on a fairly sophisticated development project. Thus when faced with the problem of transforming the ferro-cement technology, such that it could more easily and economically meet local needs, the cadre were equal to the task.



Village cadre: no mere coolies on the job

Bamboo Cement

In late 1979, a discussion took place in G. Kidul between two of YDD's field staff and one of the principal village cadre. The village head, Pak Sumarno was also present. They discussed the days' work and in particular, the rise in cost of rebar. As they had done many times before, they considered new ways in which they could reduce the quantity of rebar needed for each tank - or better still, eliminate the rebar from the construction process altogether. Then Pak Sumarno made the observation that the ferro-cement frame in many ways resembled his cassava storage bin, except of course that his storage bin was made of woven bamboo. "Would it perhaps be possible to replace some of the rebar with bamboo?," he queried. The local cadre, Pak Har, said he thought it might work and added that in constructing pit latrines, he often used a cylindrical woven bamboo liner, which he plastered with cement. Such a cylinder could conceivably be built above ground and function as a water tank.

Thus was born a new hybrid technology: Bamboo-Cement.

Experiments with the new technology progressed swiftly, with trial tanks of various shapes and sizes being built in Sidorejo. The majority of the new tanks were large ($10M^3$) cone-shaped affairs, "kind of like the Colombia rocket;" but soon a smaller "single-family" tank was designed ($4.5M^3$) which has since become the YDD standard. With the development of the small bamboo-cement tank, YDD's field staff began to witness the spread of the technology beyond their own project area. States Haryoto, one of the designers of the final bamboo tank design: "Many villagers in Gunung Kidul were already adept weavers of bamboo, thus they quickly mastered the frame construction technique. And since the

new tanks no longer required expensive rebar and chicken wire, the overall cost was now acceptable to many farmers."

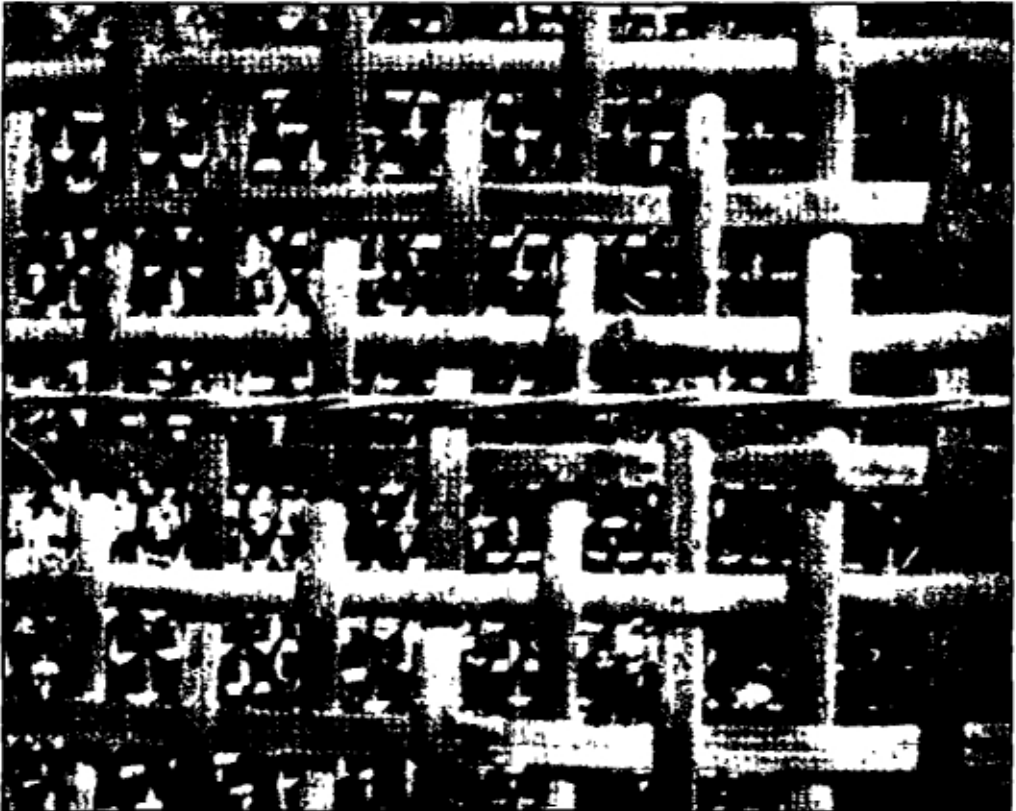

Bamboo: the basic raw material

Since the bamboo tanks' original development in 1979, some 200 have been built by villagers throughout Gunung Kidul on their own initiative. The role which trained village cadre played in this regard was again very significant. In many instances trained cadre were the principal means whereby other villagers learned of and mastered the bamboo-cement construction process. This ability of YDD trained cadre to, in turn, train other cadre is but another indication of the benefits of following a participatory approach in such development efforts.

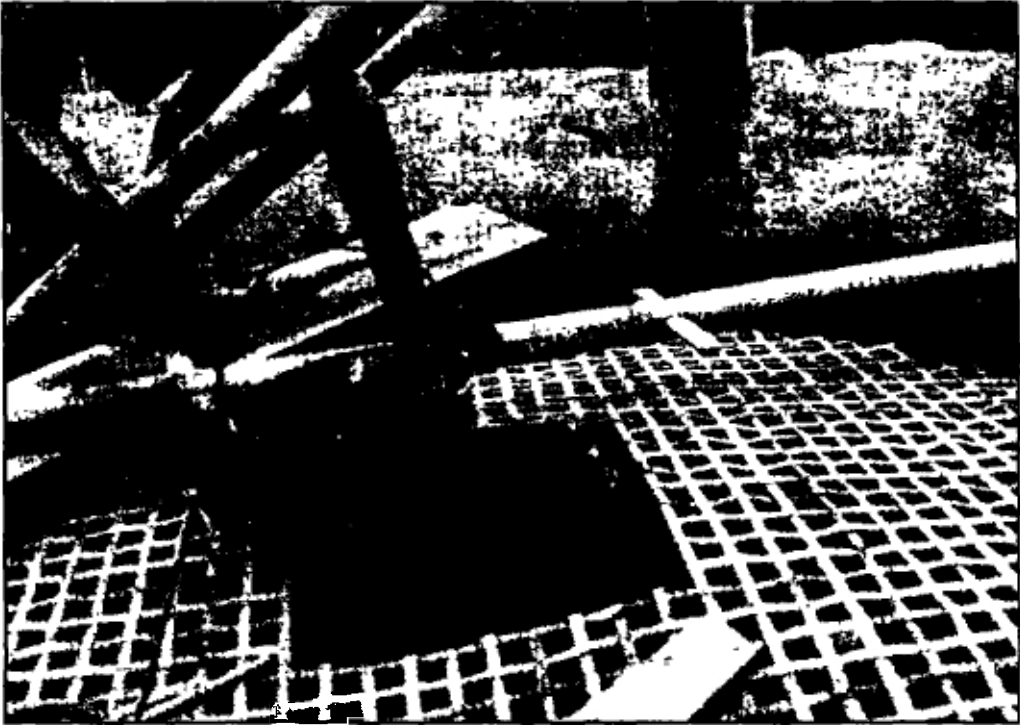

Helping hands: cadre training cadre

Problems

In 1980, YDD's "Social Section" conducted research to determine to what extent the new tanks were indeed successful in addressing the problem of dry season water scarcity. Their findings show that "misuse" or "improper use" of the tanks was rampant; and that to a large extent, the tanks were not yet achieving their intended effect on the local water situation.

They found that, ironically, the tanks were most useful in the rainy season; as at such time they were a convenient source of good, clean water. In the dry season, however, many tanks were left empty. Apparently, quite a few tank owners were exhausting their convenient supply of tank water in the transition

period between the rainy and the dry season. The tanks would then remain empty throughout the critical period of water scarcity. Further problems identified, included the indiscriminate use of the clean tank water for "non-essential" tasks such as personal bathing and watering livestock. Still another problem concerned a local (Gunung Kidul) affinity for muddy water which caused some tank owners to dump buckets of mud into their otherwise sanitary tanks. Gunung Kidul residents often described the stored rain water as "hamber" (bland). One further problem

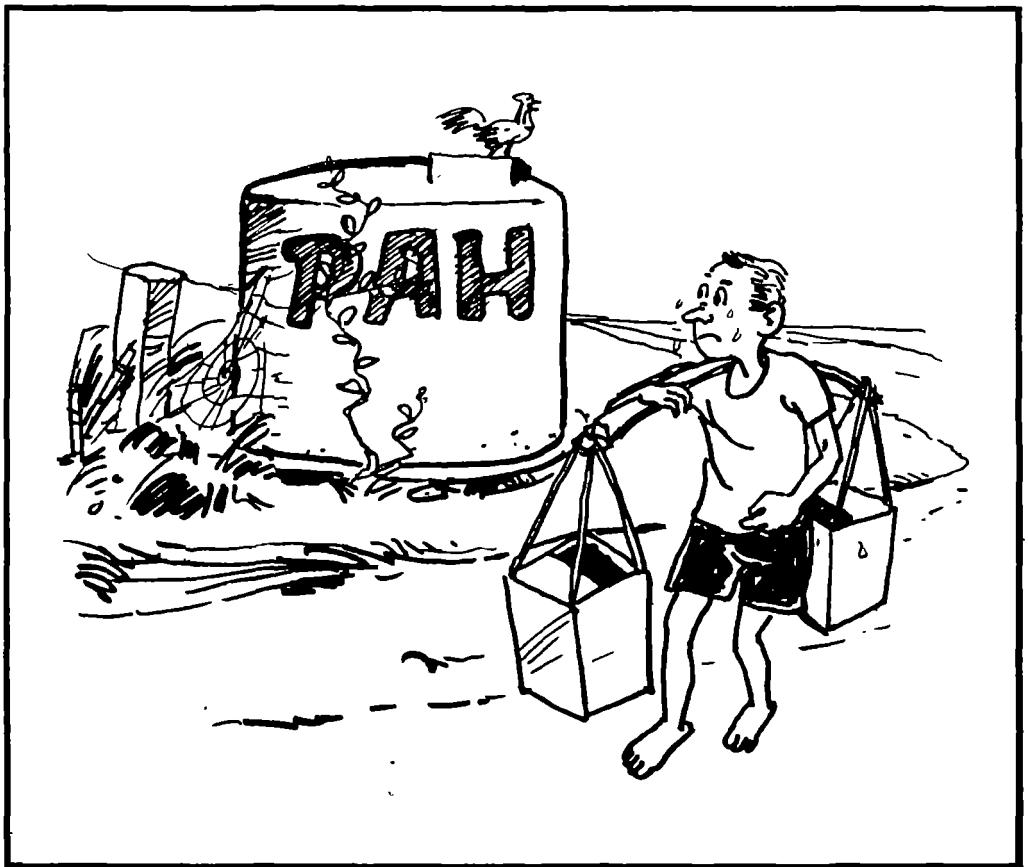

Problems, problems, problems: no water when it's most needed

had a totally unanticipated effect on existing water resources: a new local practice, that of filling the rain water catchment tanks with pond water, was increasing the overall consumption of water in Gunung Kidul, and was thus causing drainage ponds to dry up even faster than before. This practice has caused additional hardship for those families who do not yet own tanks.

YDD's social section concluded their report with a call for more controlled and intelligent use of tank water resources. They recommended improved and expanded educational efforts on YDD's part, to help insure that tank recipients would someday become more careful and conscious in the use of their emergency water supply, and as well, better managers of existing water resources.



A nearly completed bamboo-cement tank: a technical success

Impact

The biggest impact YDD water projects often have is on a supra-village level. That is, the projects constitute examples which are oftentimes adopted by supra-village agencies and organizations. In the case of ferro and bamboo-cement catchment tanks, the tank design and project approach has been followed by UNICEF, The World Bank, BañDes and the Indonesia Department of Health. Literally thousands of YDD-style tanks have been constructed by the above agencies in project sites throughout Indonesia. This wholesale adoption of an appropriate technology by the Indonesian Government is but one example of initiative in the private sector leading to large scale changes in Government policy. Indeed, many people feel that private Indonesian Foundations make their most important contribution to National Development when fulfilling this role of innovator and experimenter for the more regimented Government and quasi-Government organizations.



Literally thousands of tanks...

However, while Government and aid agencies have certainly been enthusiastic in their adoption and promotion of ferro and bamboo cement technologies, their approach has often not followed the same "careful and sympathetic" lines characteristic of YDD's work. Technical quality has also been of a lesser degree and the selection of recipient families has often not followed "most deserving, poorest of the poor" criteria. The wholesale promotion of a set tank size, irregardless of local conditions, has also plagued many such efforts.

At the village level itself, YDD tank projects have provided Indonesian villagers with an opportunity to participate in solving one of their own local problems. YDD is convinced that villagers, once exposed to such a participatory process, are more likely to remain active in the village decision making process and thus contribute more fully towards their village's development. Indeed, evidence has shown that follow-up activities run much smoother in projects where initial work was conducted on a participatory basis.

Of more immediate concern, the tanks *are* successfully functioning in many regions as the emergency water supply source they were intended to be. In parts of Nusa Tenggara Timur, Pulau Kambing and in Gunung Kidul many villagers no longer have to face the same basic lack of clean water year in and year out. Nevertheless, improper use of the tanks in these same areas has severely limited the extent to which the technology has been totally successful in solving dry region water supply problems. As YDD's own "Social Section" has advised: "more concerted and systematic attention will have to be paid to addressing the non-technical and educational problems the catchment tank technologies have spawned. Only in this manner can guarantees be made

regarding the impact these tanks will have on dry region water supply problems.

The Technology

YAYASAN DIAN DESA's design and construction methodology for a $4\frac{1}{2}$ M³ Bamboo-Cement tank is simple enough and clear enough that, with a little care, anyone with a good supply of hard bamboo and technical acumen should be able to build one on their own. The following therefore is a step by step explanation of the construction process. Note that the bamboo-cement tank described in the following pages has a capacity of $4\frac{1}{2}$ M³. While in the past YDD has experimented with larger dimensions, $4\frac{1}{2}$ M³ is now considered to be the largest size possible for a bamboo reinforced cement tank. If a larger tank is necessary, then ferro-cement or some other technology should be used. In short, base your decision on what type and size of catchment tank to build on

1. your analysis of local water needs and patterns of usage
2. local rainfall levels, and
3. the suitability and size of the catchment surface.

Do not make the mistake of constructing catchment tanks which are either too small to fulfill local needs or too large to ever be filled to capacity (due to low rainfall levels or the limited size of the catchment surface).



Design

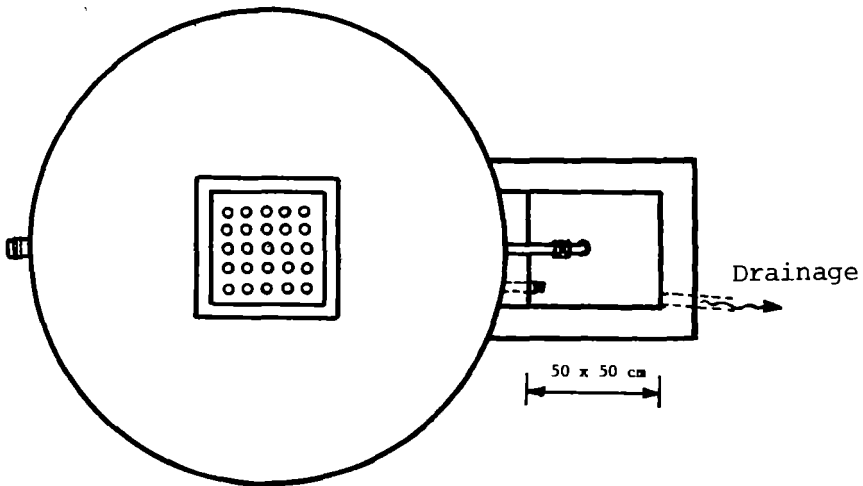
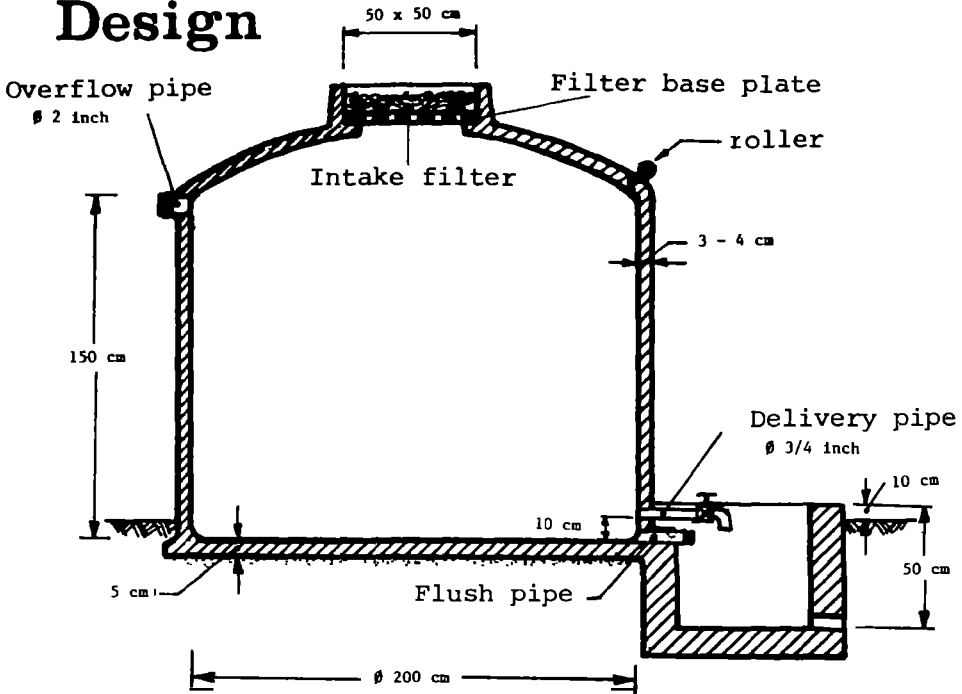

Volume : $4\frac{1}{2}$ M³

Height : $1\frac{1}{2}$ M

Diameter : 2 M

Wall Thickness : \pm 4 cm.

Inlet : rapid filter
(fibre and gravel)

Delivery : tap

Materials List

Main materials :

1. 10 (@ 40 kg) sacks of Portland Cement
2. 1 M³ of clean river sand
3. 18 large poles of bamboo

Accessories

1. 3/4 " tap
2. 3/4 " elbow pipe
3. 3/4 " delivery pipe
4. 1 " flush pipe
5. 2 " overflow pipe
6. Tank depth indicator set
(roller, string, weight,
roll gauge, plastic bottle)
7. Wire screen (for mosquito protection)
8. Palm fibre and gravel for inlet filter.

Tools

rubber gloves, hoe, trowel,
bucket, plastic string,
3 sheets of woven bamboo
matting, 6 batter boards,
bamboo twine or wire,
assorted wood planks and rope

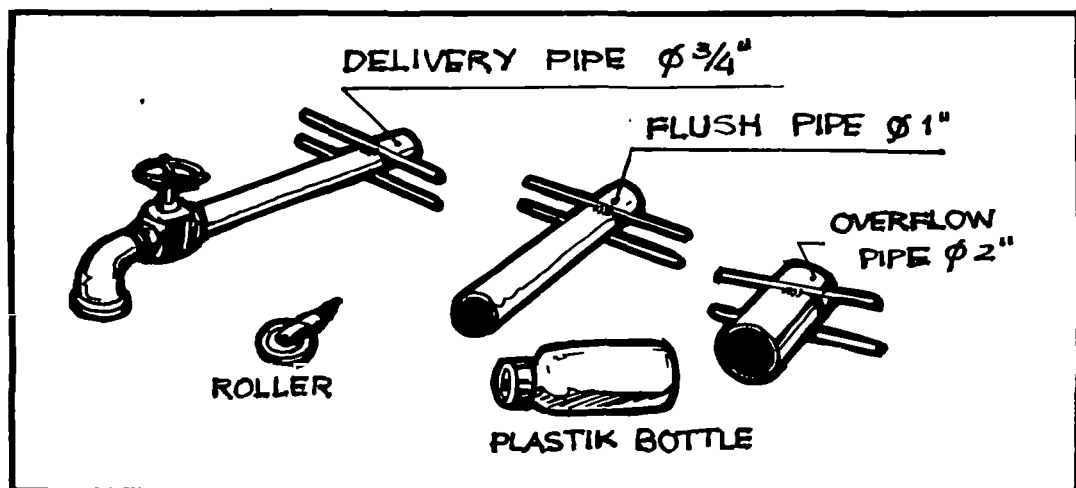

Braze rod anchors to all pipe fittings

THE CONSTRUCTION PROCESS

I. Preparing The Bamboo

1.1. Split the bamboo poles lengthwise into strips. The hard and sturdy outer skin of the bamboo is the necessary construction material. The inside "heart" of the bamboo should be separated from the outer skin with a knife and discarded. For the entire tank framework (floor, wall and top) the dimensions of bamboo strips to be prepared are the same. Only the lengths of the strips vary. All the strips must be + 2 mm thick and + 1½ cm wide. Prepare quantities and lengths as follows :

- for the wall : 35 strips, 640 cm long
 155 strips, 155 cm long
- for the floor : 120 strips, 250 cm long
- for the top : 120 strips, 250 cm long



Separating the internal "heart" from the outer skin with a sharp knife

II. Weaving the Bamboo Framework

2.1. To weave the bamboo wall, three lengths of string are first stretched out and pegged down on a flat surface. The strings should be 640 cm long and positioned on 75 cm centers.

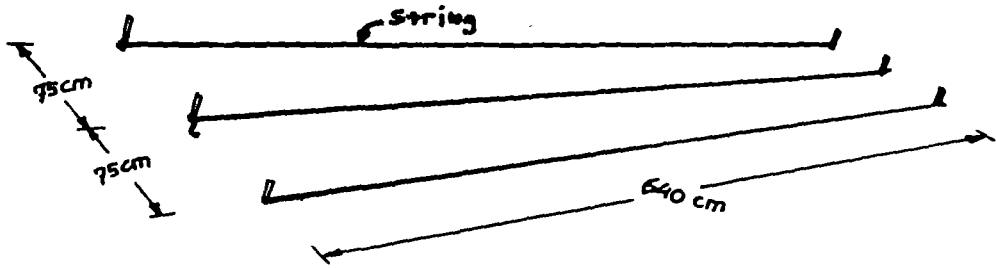

2.2. The 35 long strips of bamboo are then laid down in a parallel fashion on top of the strings. Each strip should be laid down alternately skin up, skin down, skin up, skin down; 3 cm apart. The dimension of this the "warp" portion of the weave is thus 150 cm x 640 cm.

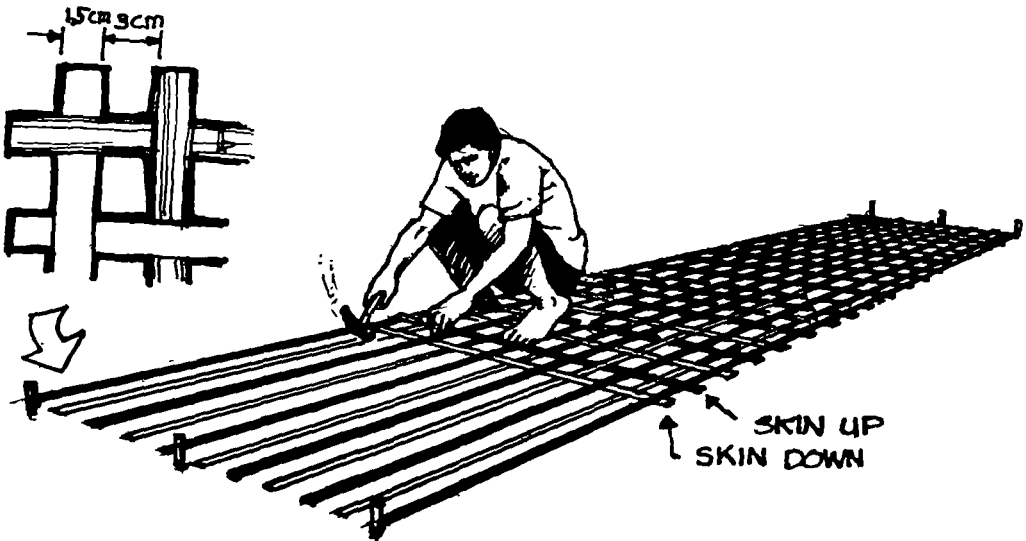

2.3. The shorter horizontal strips are then woven, in a simple over-under pattern, in between the long parallel strips. This the "weft" portion of the weave should also be on 3 cm centers and the bamboo strips should be woven alternately skin up, skin down, skin up, skin down, etc.

2.4. The edge of the finished woven sheet should immediately be secured with bamboo twine. This should keep the woven wall from unravelling.



Bamboo twine holds the woven sheets together

2.5. The next step is to roll the sheet into a large open-ended cylinder, and position the cylinder in an up-right position. The sheet ends are then interwoven and secured with bamboo twine.

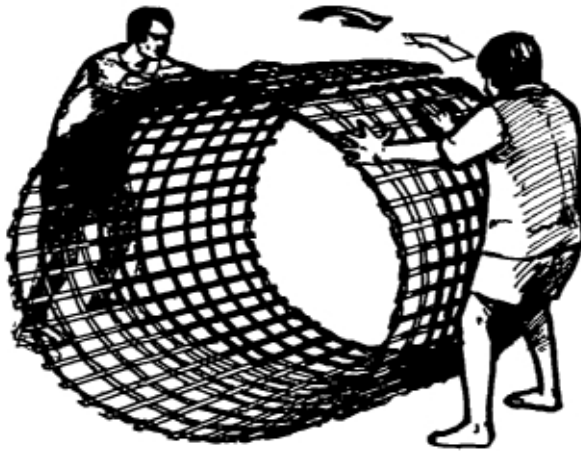

2.6. Following the same procedure described above, weave separately the tank floor sheet and top sheet. Don't forget to position the strips alternately skin up, skin down, etc. The warp and weft should once again be woven + 3 cm on center, and the sheet edges should be secured with bamboo twine. It is not necessary to use string as an aid in weaving these two smaller sheets.

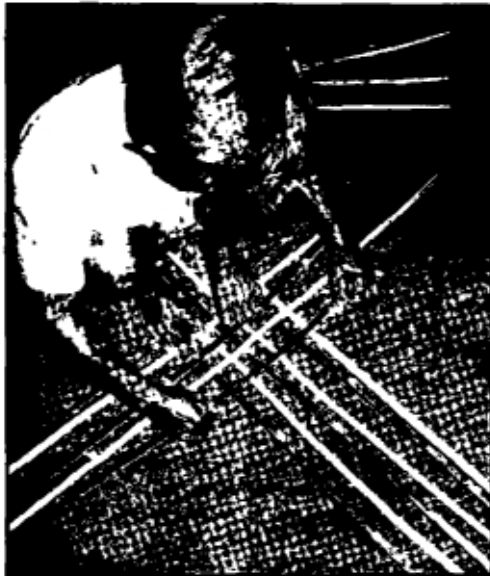

III. Assembling The Framework

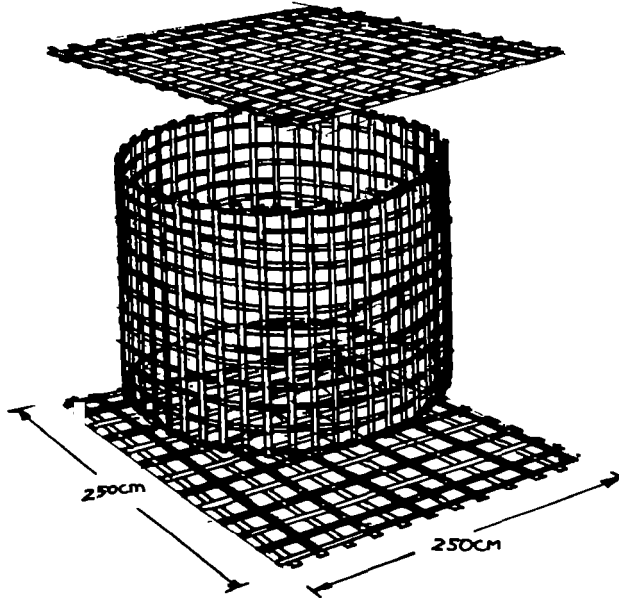

3.1. The next step in the construction process is to assemble the three woven sheets. To insure that the finished tank will have a strong, cylindrical shape, begin the assembly process by scoring a 1 M radius ring on a flat surface. Then, pound short stakes of wood or bamboo around the perimeter of the ring as illustrated below. The stakes should stick up about 10 cm and number + 30 overall.

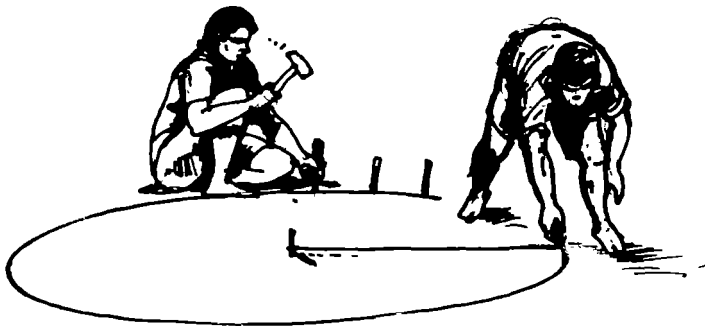

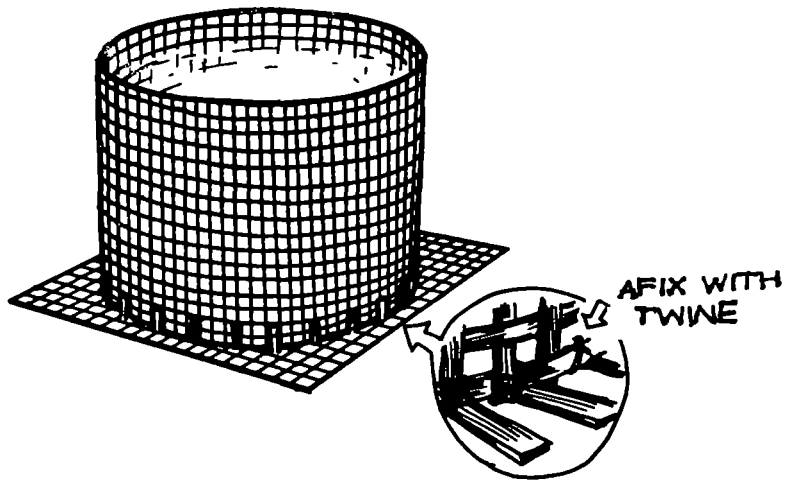

3.2. Next, lay the woven floor sheet down on top of the ring, and work the stakes in through the gaps in the weave. When the floor is in position, place the cylindrical wall down on top. Position all of the wall either inside or outside the guide stakes. When this has been accomplished, afix the wall to the floor sheet with bamboo twine or wire. Then, flip the framework over, and weave the ends of the bamboo floor strips into the edge of the cylindrical framework; thus creating a strong, but-tressed corner.

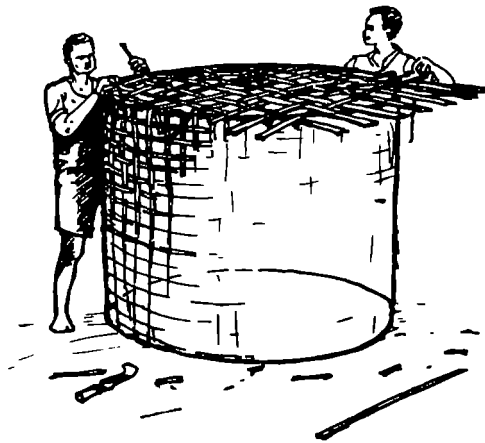

3.3. This last step is repeated exactly when afixing the tank top. The only exeption being the top piece should be forced into a bubble or domed shape as it is connected to the cylindrical wall (a bamboo pole placed inside the framework as shown in illustration will help in this regard). This will give the tank a gently curving roof. When everything has been secured with wire or twine, and all strip end pieces have been woven into the wall, the framework is finished. Use a saw to cut a $\frac{1}{2} \times \frac{1}{2}$ M hole in the exact center of the top, which will function later as the tank's intake port.

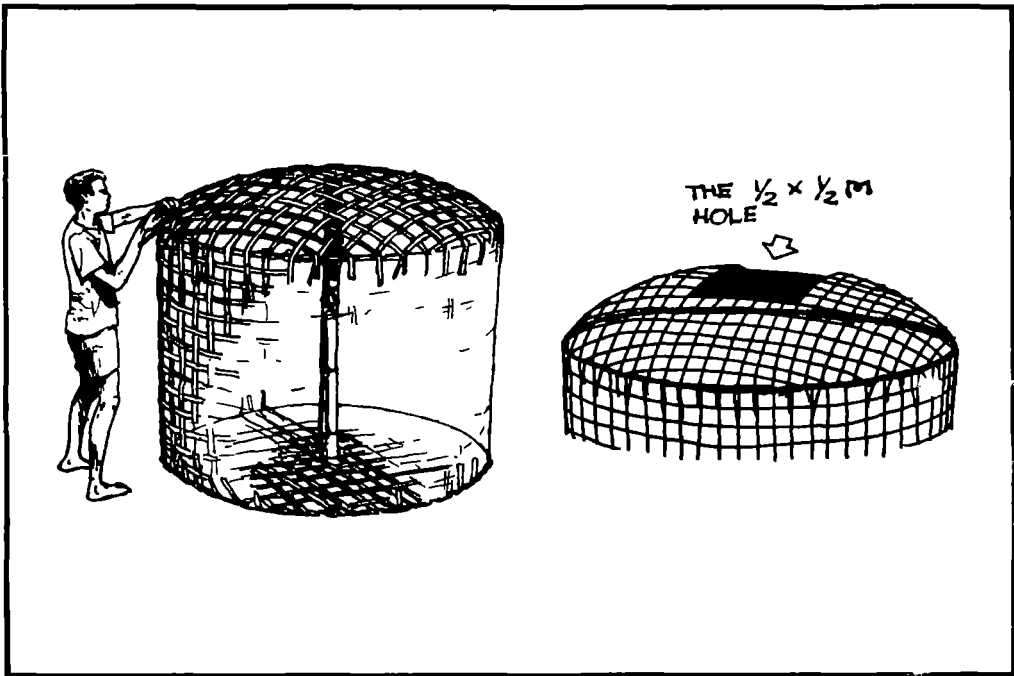

3.4. Finally, the loose strands of bamboo not integral to the frame should be burned away with fire. Use a torch or brand, but be careful not to destroy your work.

IV. Preparing to Plaster

4.1. The site chosen for the tank's eventual location must be excavated and levelled to a depth of ± 15 cm. A 2 to 3 cm layer of sand or gravel should be laid down to provide a level, homogenous bed for the tank.

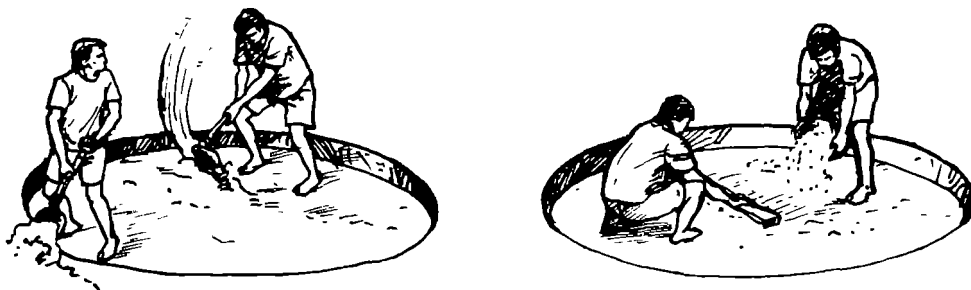

4.2. Next, cement sack paper should be spread over the entire excavated area.

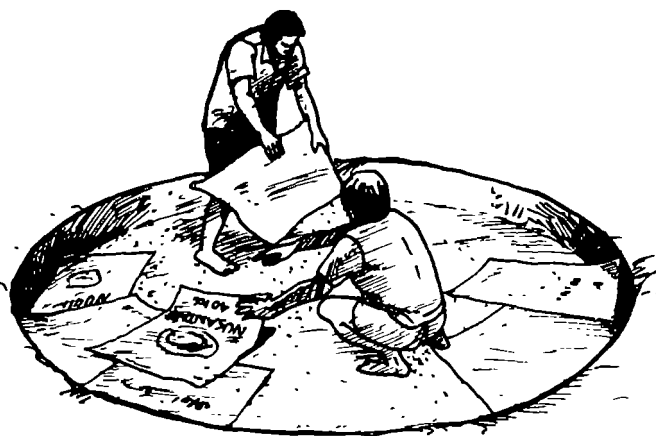

4.3. Mix quantities of plaster using dry cement and dry sand which has been strained or put through a sieve. Allow no gravel to pollute the mix! The plaster should contain 1 part portland cement, 2 parts sand and 0,4 parts water by weight. Do not use too much water as this will adversely affect the strength of the mix. Work the mortar until it becomes a smooth homogenous mass.

4.4. The framework should next be wrapped with sturdy bamboo matting, which can be reinforced with wood planks at regular intervals around the framework. Both the mats and the planks should be bound tightly against the framework with strong rope. Holes should be cut at this time for the overflow, delivery and flush pipes (see tank design figure for locations).



Left: securing the supportive matting in place with rope

Above: Positioning the overflow pipe

V. Plastering The Tank Floor (Foundation)

5.1. Spread a $\pm 2\frac{1}{2}$ cm layer of plaster on the cement sacking. Use rubber gloves to spread the plaster and masonry trowels to smooth the surface. Next, "seal" the surface by applying a mixture of pure cement and water (no sand). Apply the sealant mix with a paint brush; brushing the surface until it becomes smooth and shiny. Let the foundation sit for 15 minutes or until it begins to dry.



Plastering the foundation: be sure soil does not pollute the plaster

5.2. Position the framework on top of the foundation and install the various pipe fittings. Secure the pipes in place with twine or wire.



*Left: positioning the framework
Right: securing pipe fittings*

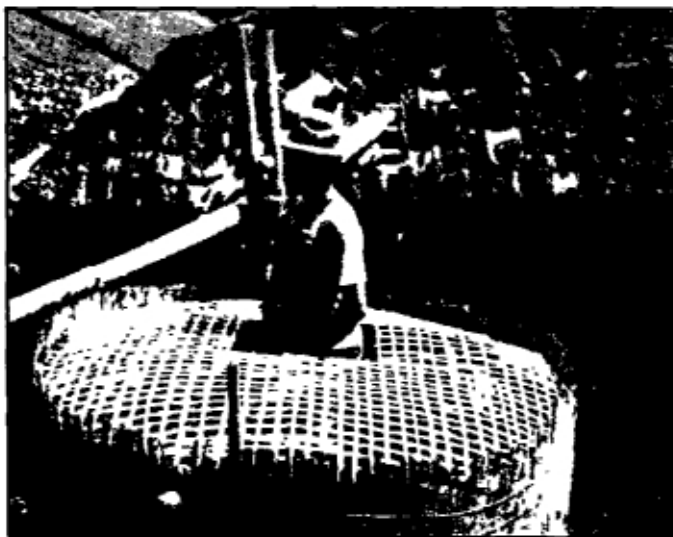

scaffolding for easy entry and exit

5.3. Now the internal plastering of the tank floor can begin. Using first rubber gloves and finally masonry trowels, spread a 2 cm layer of plaster on the tank floor. Make sure the plaster is smooth, even and penetrates into all small nooks and crannies in the bamboo framework.

Warning : Do not fail to completely plaster over ever bit of bamboo ! Exposed portions of bamboo may be subject to rot or insect infestation.



*Left: internal plastering of the tank floor
Right: applying plaster with rubber gloves*

VI. Plastering The Tank Wall

6.1. Immediately after plastering the floor, begin to plaster the inside of the tank wall. Begin at the bottom of the tank and work upwards, using rubber gloves. Apply a thin layer only to the tank wall, but add extra plaster where the wall and floor meet. This portion of the tank will be under considerable pres-

sure when the tank is filled, so make it extra strong. Reinforce as well the areas around all pipe fittings.

6.2. Continue to apply plaster with rubber gloves until the entire inside wall is completely covered. Do not stop to rest until this portion of work is completed.

6.3. Now, take a rest and let the plastered floor and wall dry a little. After waiting a half an hour, begin to apply a second layer of plaster to the internal tank wall. This time use a mason's trowel and make the wall as smooth and even as possible. The combined thickness of the two layers should total ± 2 cm. Finally, "seal" the tank's internal floor and wall by brushing on a mixture of pure cement and water. Make the walls as smooth and shiny as you can. Rubbing the surface with cement sacking will help to eliminate all the small pores and irregularities.



A second coat of plaster is applied with masonry trowels

6.4. Wait about 2 hours to let the plastered portions of the tank become somewhat dry. Only then will it be safe to remove the supportive wrapping of rope, planks and bamboo mats. Allow the tank to dry for an additional 1 hour, after removal of the supports. Next, begin to plaster the external tank wall; this time using just the masonry trowels. Apply just a thin layer of plaster (+ 2 cm), but be sure to completely cover all exposed bamboo and repair any irregularities in the surface. Again, make the surface as smooth as possible, and finish the job by brushing on a mixture of pure cement and water, and by rubbing the surface with cement sacking (or banana leaves). Wait 12 hours and then begin to plaster the tank top (roof).

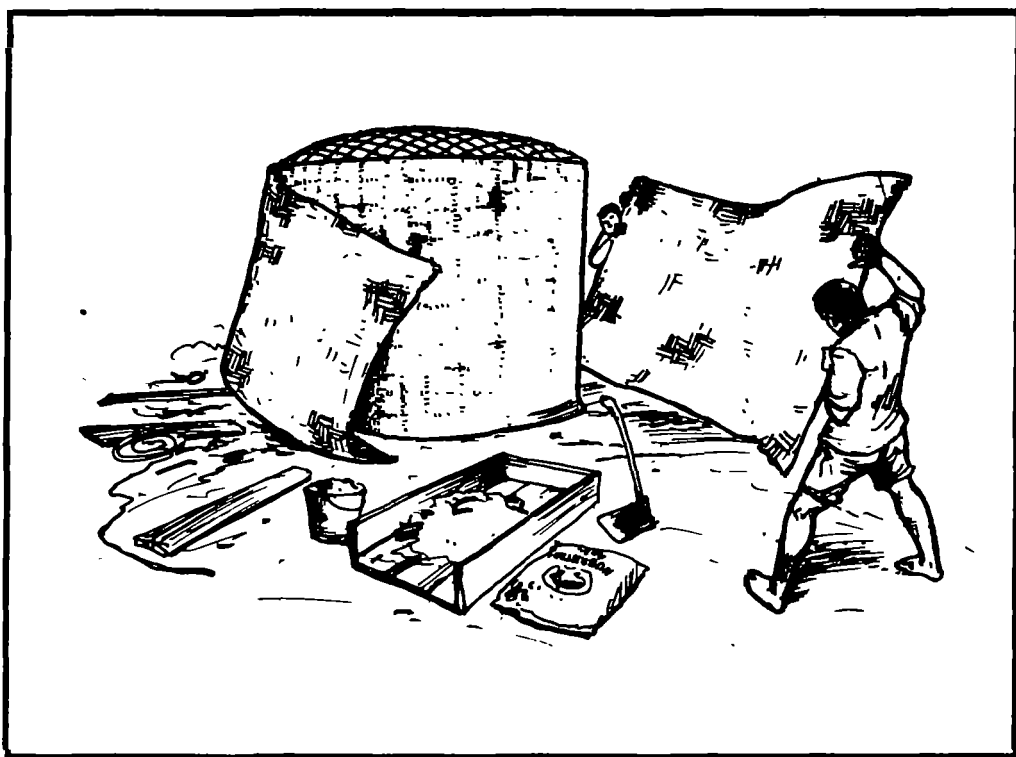



*Left: removing the supportive mats
Right: plastering the outer wall*

VII. Plastering The Tank Top (Roof)

7.1. Before plastering the roof, it is necessary to construct a supporting formwork of bamboo matting, wood planks and poles inside the tank. This formwork will act as a backing for the externally applied cement plaster. The formwork must be strong enough to support the weight of the cement plaster and that of one or two workers.

7.2. Next, insert a number of small cement "props" between the woven top sheet and the formwork backing. These small props (which can be made from plaster, cast into small 3 x 4 cm blocks) will allow the plaster, when applied, to penetrate and cover both sides of the woven top. When this has been accomplished,

begin to plaster the tank top. Using rubber gloves, spread the plaster evenly over the roof; being careful to fill in all the holes and gaps. Do not plaster over the intake port, rather, plaster to its edge in a neat and orderly fashion. When the top has been smoothly and evenly plastered, make a hole for the depth indicator and position and install the metal roller (see design figure for location).



Left: positioning bamboo and wood plank supports in preparation of plastering the tank roof. Below: Plastering the roof



7.3. Next, construct a simple wooden mold or form for the intake filter box, place it over the intake port, and fill the mold with thick plaster. Experience has shown that removing the inner walls of the form is easier when the casting is still somewhat wet. However, wait until it is almost completely dry before attempting to remove the outer form walls. Repair any inadequacies in the casting by applying more plaster. Next, smooth and seal the entire surface of the roof as described previously.



Filling the wooden intake port mold with plaster

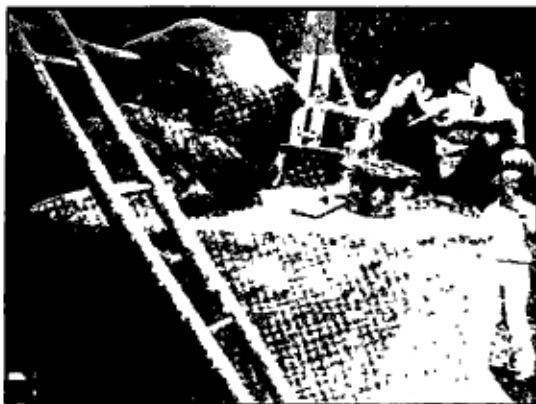

Finishing work...

Wait 3 or 4 days before disassembling the internal formwork. Finish the underside of the roof by applying more plaster where needed and by smoothing and sealing the surface as described previously. Fill the tank at this time with about 10 cm of water. Splash water on the tank daily for 10 days. At all times during this "curing" period keep the tank shaded from the sun. These measures will ensure that the tank dries slowly and does not develop cracks.



VIII. Constructing The Delivery Box

8.1. The delivery box is meant to provide a clean location in which to draw water, and can be constructed from mortared brick, stone or coral. It should be made big enough to accept local water jars or cans; $\frac{1}{2} \times \frac{1}{2} \times \frac{1}{2}$ M is in general an appropriate size.



An extra large delivery box

The delivery box is normally provided with a drainage pipe to prevent spilled water from becoming a breeding ground for pesky mosquitoes. However in particularly dry regions even this small amount of water should not be wasted and can be used to water gardens or livestock.

IX. Finishing Touches

9.1. Finish the tank by installing the depth indicator set; and fine mesh screen in the overflow pipe. Construct a thin bamboo-cement disc, replete with large perforations, to act as the base plate for the rapid filter in the intake port. Install the plate in the intake port and fill the remaining portion of the box with palm fibre, gravel or other suitable materials.



The bamboo-cement filter base plate

9.2. Finally, position a sheet metal or bamboo gutter to channel rain water from the catchment surface into the tank. Depending on rainfall levels, you may need to use the catchment area of several roofs to harvest a sufficient quantity of water. Be sure to consider this factor when choosing tank locations.

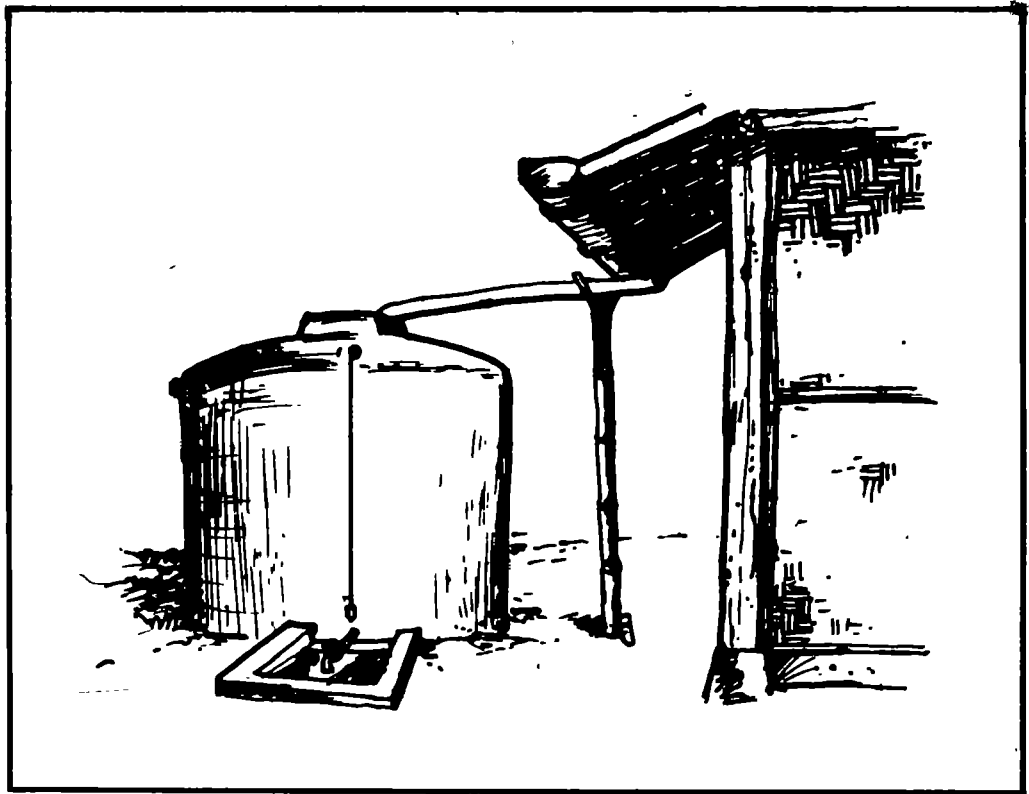

X. Construction In Areas Where Bamboo Mats Are Not Available

10.1. Inexpensive bamboo mats, used as walls in home construction, are common throughout much of The Republic of Indonesia. However, as such craft is not found everywhere, an alternative construction process has been developed using burlap fabric. This alternative method simply entails sewing 9 or 10 split burlap sacks together, to form a large sheet which can then serve as a replacement for the bamboo mats used to wrap and support the framework during the internal plastering. A more liberal use of supportive wood planks is advisable, as the burlap fabric is not nearly as stiff as the bamboo mats.

XI. Maintenance

11.1. Maintenance begins immediately after the tank has been built. Be sure to keep the tank shaded for 10 - 15 days and splash the tank with water to help it dry slowly and evenly and cure without cracking. Never let the tank become completely dry. In daily use, keep the tank and the surrounding area clean and tidy, and allow no foreign matter to pollute the clean, stored water. Manage and control the use of the tank's water such that it fulfills its intended role as an emergency water supply.

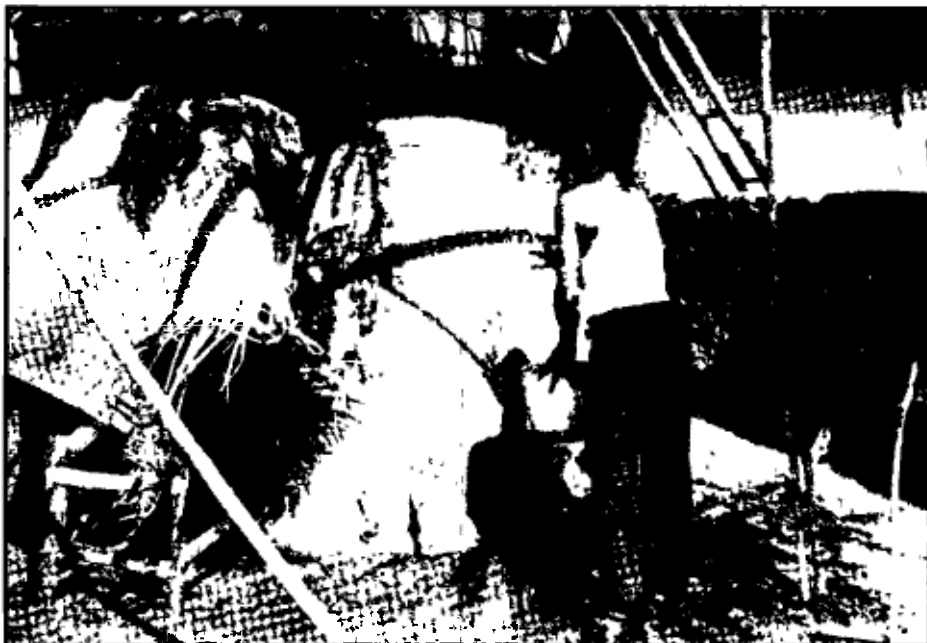

Sprinkle the new tank with water daily

11.2. If signs of cracking do appear, repair the cracked portion immediately, as neglected cracks can grow and grow and ruin the tank. Insects can also infest the tank through cracks, so be careful.

Cracks are most often caused by :

1. Poorly proportioned plaster mixes (too much water, not enough cement, etc.).
2. Poor quality sand or water containing silt or organic matter.
3. Improperly or unthoroughly mixed plaster.
4. Pollution of the plaster by gravel or soil.
5. Thin or weak sections in the bamboo-cement wall.
6. Failure to properly cure or shade the tank in the weeks following construction.

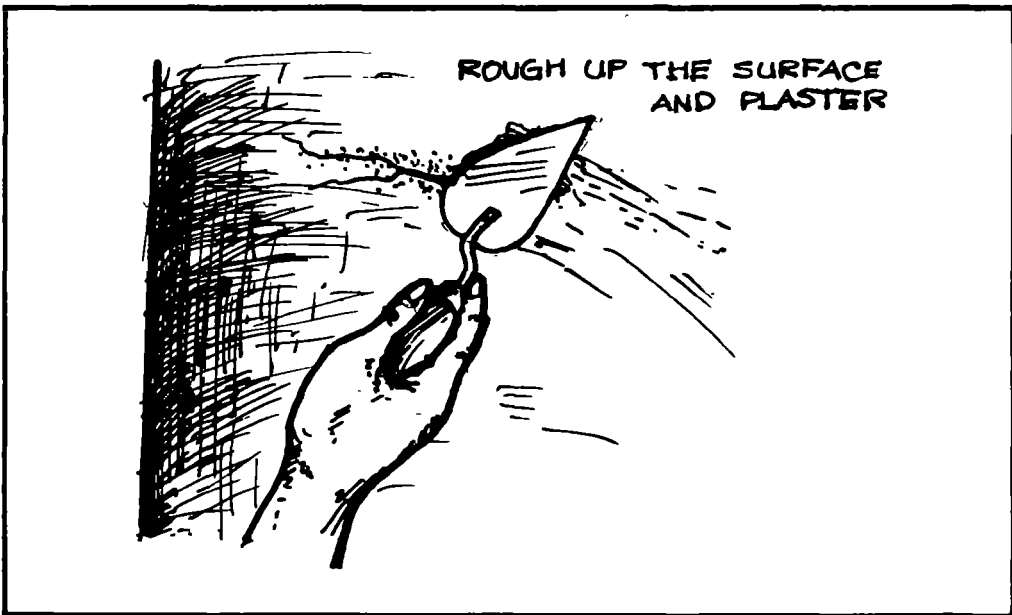

11.3. Repair shallow cracks on the tanks outer surface by roughing up the surface around the crack, moistening the area with water, and then filling the crack with plaster. Smooth the repaired portion with cement paper.

11.4. Deeper cracks which penetrate inside the tank require a more elaborate repair. Chisel away the cement in the area around the crack, cover the wound with chicken wire and then plaster the hole shut from both sides of the wall. Splash water on the repair for a few days to help the patch cure slowly.

11.5. Leaks in the tank's floor are most often due to an insufficient thickness in the plaster. Rough up the surface of the floor with a chisel, and then apply an extra 2 cm layer of plaster. Smooth and seal the plaster as during construction.

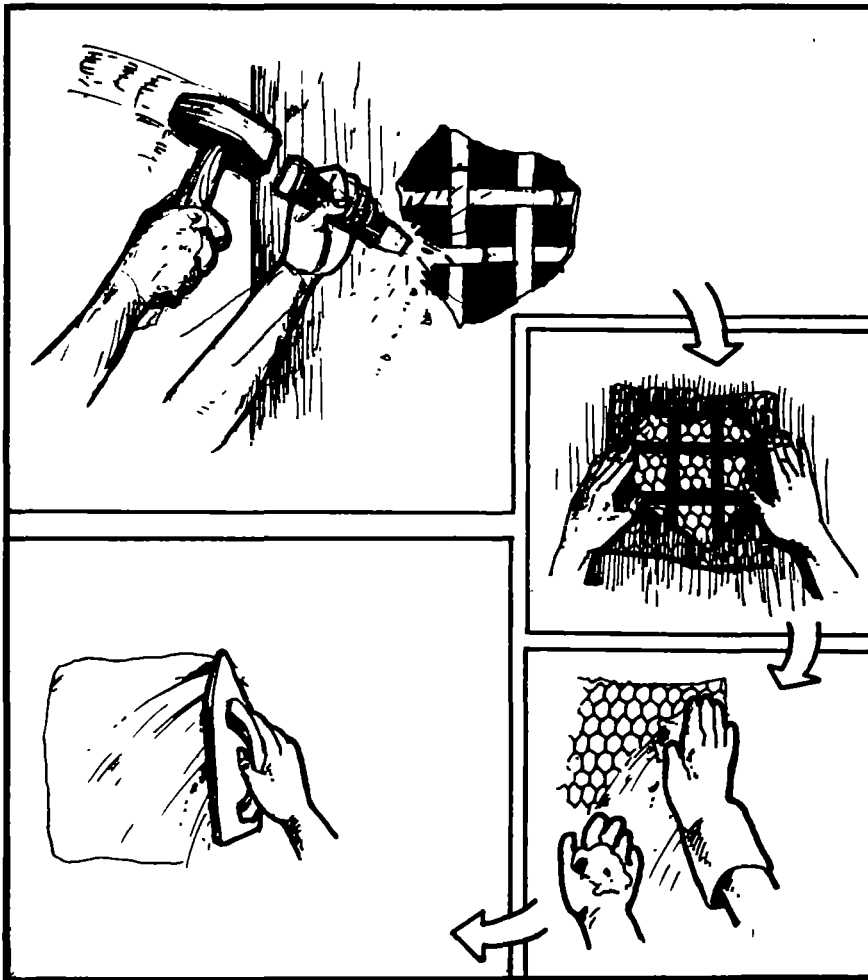

The Participatory Approach

As Dian Desa's own field staff and social researchers have repeatedly discovered, the ultimate "perfection" of a piece of technology in no way guarantees its troublefree and successful introduction at the village level. Indeed, non-technical social, educational and attitudinal considerations are just as likely to adversely affect project success, as the relative "appropriateness" of the new technology itself.

In Gunung Kidul, Dian Desa's field staff were helped out of a difficult technical conundrum by the local village cadre. Their participation in, and responsibility for project activities, implicitly encouraged an innovative and creative role on their part. However, non-technical problems associated with the technology, especially those relating to the habits and idiosyncracies of the tank's "end users", have affected, to a great extent, the smooth attainment of overall project goals.

Villager participation in development activities must not, therefore, be limited just to the local crew of kader working on the project. A concerted effort must be made to foster an understanding of, and commitment to, project activities and goals; and this amongst every sector of the local community. However, just as the preferred technology must be appropriate to local needs, non-technical "soft-ware" programs must also match the needs and capabilities of field staff and local villagers. Systematic attempts to address non-technical problems (such as "participatory needs assesment", "group problem solving" or programs in Non-Formal Education) will have little chance of success if more basic and preliminary outreach work

has not been accomplished beforehand. Dian Desa's approach includes the long-term residency of its' field staff in all project villages. Through simple and straightforward discussions and interactions with the local villagers they seek to attain a degree of intimacy and familiarity with local problems; and villagers own feelings regarding possible solutions. Such long-term interactions should at all times form the basis of *The Participatory Approach*.



