

213.0 82PR

PROCEEDINGS OF THE  
INTERNATIONAL CONFERENCE  
ON  
RAIN WATER CISTERN SYSTEMS

INTERNATIONAL CONFERENCE CENTRE  
for Community Water Supply

June 1982



WATER RESOURCES RESEARCH CENTER  
UNIVERSITY OF HAWAII AT MANOA  
Honolulu, Hawaii 96822

LO: 2130.82 PR  
150-1108

f 169,30 wa Waltman

**DISCLAIMER**

Contents of this publication do not necessarily reflect the views and policies of the sponsors of this conference, nor does mention of trade names or commercial products constitute their endorsement or recommendation.

**COVER PHOTOGRAPH**

The photograph of a redwood rain catchment tank, surrounded by mountain foliage on the slopes of Tantalus, O'ahu, was taken by Dr. Yu-Si Fok.

**PUBLICATIONS STAFF**

Faith N. Fujimura ..... Editor  
Jean T. Nakahodo ..... Publications Assistant  
April W.L. Kam ..... Graphic Illustrator  
Grace Young ..... Student Typist

\$35/copy  
For information write to:  
Water Resources Research Center  
2540 Dole Street, Holmes Hall 283  
Honolulu, Hawaii 96822-U.S.A.

PROCEEDINGS OF THE  
INTERNATIONAL CONFERENCE  
ON  
**RAIN WATER CISTERN SYSTEMS**

GENERAL CHAIRMAN  
Yu-Si Fok

June 1982

LIBRARY, INTERNATIONAL REFERENCE  
CENTRE FOR COMMUNITY WATER SUPPLY  
AND SANITATION (IRC)  
P.O. Box 93190, 2509 AD The Hague  
Tel. (070) 214911 ext 141/142  
RN: 150 = 1108  
LD: ~~#WRRC 82~~ 213.0 82PR

LIBRARY  
International Reference Centre  
for Community Water Supply

EDITOR  
Faith N. Fujimura

SPONSORS  
U.S. Department of the Interior  
Office of Water Research and Technology  
University of Hawaii at Manoa,  
Water Resources Research Center

~~KD 4068~~  
71 71  
IN 82 WRRC 8:  
articles:  
KD 4068 - 4076  
ISN 1108

**INTERNATIONAL CONFERENCE ON RAIN WATER CISTERN SYSTEMS**

15-17 June 1982  
Prince Kuhio Hotel  
Honolulu, Hawaii

**SPONSORS**

U.S. Department of the Interior  
Office of Water Research and Technology  
University of Hawaii at Manoa,  
Water Resources Research Center

**COSPONSORS**

International Water Resources Association  
World Bank  
UNESCO  
United Nations Environment Program  
American Geophysical Union  
American Society of Agricultural Engineers  
American Society of Civil Engineers  
American Water Resources Association  
American Water Works Association  
Water Pollution Control Federation, Hawaii Chapter  
University of Hawaii at Manoa,  
College of Engineering

**GENERAL CHAIRMAN**

Dr. Yu-Si Fok, Professor  
Department of Civil Engineering  
and Researcher  
Water Resources Research Center  
University of Hawaii at Manoa

**PROGRAM ARRANGEMENTS**

College of Continuing Education  
and Community Service,  
University of Hawaii at Manoa

## GENERAL CHAIRMAN

Dr. Yu-Si Fok

## CONFERENCE COMMITTEES

### EXECUTIVE & ADVISORY

Dr. John J. Cassidy, Director  
Water Research Center  
Washington State University  
Pullman, Washington 99163-USA

Dr. Chao-Lin Chiu, Professor  
Dept. of Civil Engineering  
University of Pittsburgh  
Pittsburgh, Pennsylvania 15213-USA

Dr. Ven Te Chow, Professor  
Dept. of Civil Engineering  
University of Illinois  
Urbana, Illinois 61801-USA

Dr. John S. Gladwell, Director  
Division of Water Sciences, UNESCO  
7, Place de Fontenoy  
75700 Paris, FRANCE

Dr. Yoshiaki Iwasaki, Professor  
Hydraulics Laboratory  
Dept. of Civil Engineering  
Sakyo-Ku, Kyoto, JAPAN

Dr. A. Ivan Johnson, P.E.  
Consulting Engineer  
7474 Upham Court  
Arvada, Colorado 80003-USA

Dr. L. Stephen Lau,  
Water Resources Research Center  
University of Hawaii at Manoa  
2540 Dole Street, Holmes Hall 283  
Honolulu, Hawaii 96822-USA

Mr. R. Olembo, Acting Director  
Div. of Environmental Management  
UN Environmental Programme  
P.O. Box 30552  
Nairobi, KENYA

Dr. James Wiggert, Professor  
Dept. of Civil Engineering  
Virginia Polytechnic Institute  
Blacksburg, Virginia 24061-USA

Dr. Ben C. Yen, Professor  
Dept. of Civil Engineering  
University of Illinois  
Urbana, Illinois 61801-USA

### ORGANIZING

Dr. Koichi Aki  
166 Sakuragaoka  
Hodogaya, Yokohama, JAPAN

Dr. Mahmoud Abu-Zeid, Director  
Ministry of Irrigation  
Cairo, EGYPT

Dr. Ellis L. Armstrong, Consultant  
3709 Brockbank Drive  
Salt Lake City, Utah 84117-USA

Dr. Asit K. Biswas, President  
International Society of  
Ecological Modeling  
76 Woodstock Close  
Oxford, England OX2 8DD-U.K.

Ing. Alejandro Giron Braghirolli  
17 Av. 8-46  
Guatemala City 11, GUATEMALA

Dr. Nathan Buras  
Faculty of Agricultural Engineering  
Israel Institute of Technology  
Haifa 32000, ISRAEL

Arg. Luis Sánchez de Carmona  
Director General de Ecología Urbana  
Humanos y Obras Publicas  
Constituyentes No. 947  
Col. Belem de Las Flores  
México 18, D.F., MÉXICO

Ing. Luis Viega da Cunha  
National Institute of Technology  
Av. do Brasil  
Lisbon 5, PORTUGAL

Mrs. Srimoerni Doelhomid  
Jalan Bank 5, No. 8  
Jakarta, Selatan, INDONESIA

Dr. Yu-Si Fok, *ICORWCS Cochairman*  
Water Resources Research Center  
University of Hawaii at Manoa  
Honolulu, Hawaii 96822-USA

Dr. Jean J. Fried, Director  
Institut de Mécanique des Fluides  
2, Rue Boussingault  
67000 Strasbourg, FRANCE

**ORGANIZING—Continued**

Mr. C.H. Gischler  
Regional Hydrologist  
for Latin America  
UNESCO

Bulevar Artigas 1320-24  
Casilla de Correo 859  
Montevideo, URUGUAY

Dr. Janusz Kindler, Chairman  
Resources & Environment Area  
International Institute for  
Applied Systems Analysis  
Schloss Laxenburg, AUSTRIA

Dr. Soontak Lee  
Dept. of Civil Engineering  
Yuengnam University  
Taegu, KOREA

Prof. Dr. Emil F. Mosonyi, Director  
Institut für Wasserbau und  
Wasserwirtschaft  
75 Karlruhe 1  
Kaiserstrasse 12, WEST GERMANY

Mr. Kamil Ali Mohamed  
Director of Nile Waters  
Khartoum, SUDAN

Mr. Y.K. Murthy  
c/o Central Board of Irrigation  
and Power  
Kasturba Gandhi Marg  
New Delhi 110001, INDIA

Dr. Carpofofo Olivares  
Oficina Tecnica de Estudios  
Hidraulicas  
Edificio Candilito piso 6  
Av. Urdaneta esq. Candilito  
Caracas 101, VENEZUELA

Dr. George S. Ongweny  
University of Nairobi  
P.O. Box 30197  
Nairobi, KENYA

Prof. Dr. S.J. Perrens, *ICORWCS*  
*Cochairman*  
The University of New England  
Armidale, N.S.W., AUSTRALIA 2351

Ing. Rubem La Laina Porto, Director  
Centro Tecnológico de Hidraulica  
Cidade Universitaria  
São Paulo, BRASIL

Dr. Peter J. Reynolds  
Water Planning & Management Branch  
Environment Canada  
Inland Waters Directorate  
Ottawa, Ontario KIA-OE7, CANADA

Ing. Oscar Vega Roldán  
c/o C.I.E.P.S., S.C.  
Córdoba 127  
México 7, D.F., MÉXICO

Mr. Leonard E. Taylor  
Central Water Planning Unit  
Reading Bridge House  
Reading RG1 8PS, U.K.

Ing. Andrew D. Therianos  
P.O. Box 1414  
Omonia, Athens, GREECE

Ing. Oscar Gregorio Velez  
Subsecretaría de Informática  
Secretaría de Planeamiento  
25 de Mayo 459-P.B.  
1002 Buenos Aires, ARGENTINA

**TECHNICAL**

Dr. Samir A. Ahmed, Professor  
Dept. of Civil Engineering  
Oklahoma State University  
Stillwater, Oklahoma 74074-USA

Mrs. Faith N. Fujimura, Admin. Asst.  
and Editor  
Water Resources Research Center  
University of Hawaii at Manoa  
2540 Dole Street, Holmes Hall 283  
Honolulu, Hawaii 96822-USA

Dr. PingSun Leung, Asst. Professor  
Dept. of Agricultural & Resource  
Economics  
University of Hawaii at Manoa  
2545 The Mall, Bilger Hall 302  
Honolulu, Hawaii 96822-USA

Dr. Andrew Lo  
Dept. of Agronomy & Soil Science  
University of Hawaii at Manoa  
3190 Maile Way  
Honolulu, Hawaii 96822-USA

Dr. Kaw-Kai Wang, Professor  
Dept. of Agricultural Engineering  
University of Hawaii at Manoa  
3050 Maile Way, Gilmore Hall 110  
Honolulu, Hawaii 96822-USA



*To Dr. Ven Te Chow*  
Scholar, Scientist, Humanitarian, Friend  
(19 August 1919-30 July 1981)

## CONTENTS

### HISTORY OF CISTERNS

Lessons of History in the Design and Acceptance of Rain Water Cistern Systems. . . . .	1
<i>George W. Reid</i>	
Outlook on Ancient Cisterns in Anatolia, Turkey. . . . .	9
<i>Ünal Öziş</i>	
History of Yucatán Cisterns. . . . .	16
<i>Tuchée Gordillo, Ernesto González L., and Salvador Gaona V.</i>	
X Present and Past Development of Catchment Areas in the Mediterranean Coastal Desert of Egypt . . . . .	23
<i>Abdu A. Shata</i>	
X Rain Water Cistern Systems for the Himalayan Region. . . . .	33
<i>Raj Kumar Gupta and Vidya Sagar Katiyar</i>	
Carthaginian-Roman Cisterns in Sardinia. . . . .	37
<i>Francesca M. Crasta, Costantino A. Fassò, Francesco Patta, and Giorgio Putzu</i>	

### RAINFALL ANALYSIS

Stochastic Dynamic Models for Rainfall Processes . . . . .	46
<i>Samir A. Ahmed and Yu-Si Fok</i>	
Stochastic Model of Daily Precipitation Using the Time Series Methodology. . . . .	54
<i>Silvia Vega and S. Gaona V.</i>	
Estimation of Extreme Point Rainfall over Peninsular India. . . . .	61
<i>O.N. Dhar, P.R. Rakhecha, and A.K. Kulkarni</i>	
Frequency Distribution of Weekly Rainfall at Bahadradabad, India . . . . .	68
<i>S.M. Seth, Jagdish Mohan, and S.S. Tiagi</i>	
General Methodology for the Characterization of Rainfall Time Distribution. . . . .	77
<i>Van-Thanh-Van Nguyen</i>	
Deterministic and Probabilistic Processes of Weekly Rainfall . . . . .	83
<i>Yu-Si Fok, Ronald H.L. Fong, Edwin T. Murabayashi, and Andrew Lo</i>	
Computerized Methods in Optimizing Rainwater Catchment Systems. . . . .	92
<i>Eric J. Schiller and Brian Latham</i>	
Hydrographs for Roof-Top Runoff Under Varying Rainfall Conditions. . . . .	102
<i>Bhaskar Datta and G.C. Mishra</i>	



**DESIGN, COST, AND POLICY**

	Design Strategy for Domestic Rainwater Systems in Australia . . . . .	108
	<i>S.J. Perrens</i>	
	Feasibility Analysis of Rain Water Cister Systems as an Urban Water Supply Source. . . . .	118
	<i>Shuichi Ikebuchi and Seiji Furukawa</i>	
	Determining the Desirable Storage Volume of a Rain- Catchment Cistern System: A Stochastic Assessment . . . . .	128
	<i>PingSun Leung and Yu-Si Fok</i>	
X	Optimal Catchment Design by Marginal Analysis. . . . .	135
	<i>Richard J. Heggen</i>	
	Application of Gould Matrix Technique to Roof Water Storage. . . . .	144
	<i>Terry L. Piggott, Ian J. Schiefelbein, and Mark T. Durham</i>	
X	Design and Calculation of Rainwater Collection Systems . . . . .	151
	<i>C.L.P.M. Pompe</i>	
✱	Assessment of Rainwater Catchment and Storage Systems on Majuro. . . . .	158
	<i>Rebecca A. Stephenson, Hiro Kurushina, and Stephen J. Winter</i>	
	Adjusting Operation Policy for a Rain Water-Cistern System. . . . .	164
	<i>Andrew Lo and Yu-Si Fok</i>	
X	Reliability of Roof Runoff in Selected Areas of Indonesia. . . . .	171
	<i>J.L. Irish, Sukarna, and D. Murdiyarso</i>	
X	Rain Water as a Water Supply Source in Bermuda . . . . .	184
	<i>D.H. Waller</i>	
	Rain Water Collection and Utilization at Tamil Nadu Agricultural University, Coimbatore, India . . . . .	194
	<i>R.K. Sivanappan</i>	
	Rain Water as an Alternative Source in Nova Scotia . . . . .	202
	<i>D.H. Waller and D.V. Inman</i>	
✱	Cost Analysis of Rain Water Cistern Systems. . . . .	210
	<i>Yu-Si Fok and PingSun Leung</i>	
	Some Aspects of Roof Water Collection in a Subtropical Region. . . . .	220
	<i>Adhityan Appan</i>	
	Rain Water Cistern System Impact on Institutional Policy. . . . .	227
	<i>Yu-Si Fok</i>	

**WATER QUALITY**

✱	Quality of the St. Thomas, U.S. Virgin Islands Household Cistern Water Supplies . . . . .	233
	<i>G. Fred Lee and R. Anne Jones</i>	

Effect of Acid Rain on Cistern Water Quality . . . . .	244
<i>Thomas L. King and P.B. Bedient</i>	
Occurrence of Selected Heavy Metals in Rural Roof-Catchment Cistern Systems . . . . .	249
<i>William E. Sharpe and Edward S. Young</i>	
✧ A Water Quality Argument for Rainwater Catchment Development in Belau . . . . .	257
<i>Charles Romeo</i>	
✧ Rain Water Cistern Utilization in Selected Hamlets of the Republic of Belau, Western Caroline Islands . . . . .	266
<i>Christine O'Meara</i>	
✧ Roof Catchments: The Appropriate Safe Drinking Water Technology for Developing Countries. . . . .	276
<i>B.Z. Diamant</i>	
<b>CURRENT AND FUTURE PRACTICES</b>	
Recent Initiatives in Raintank Supply Systems for South Australia. . . . .	284
<i>Peter J. Hoey and Stephen F. West</i>	
✓ Rural Rainwater Cistern Design in Indonesia. . . . .	294
<i>Winarto</i>	
✧ Rainwater Collectors for Villages in West Java, Indonesia. . . . .	299
<i>Ron van Kerkvoorden</i>	
Effect of Rationing on Reliability of Domestic Rainwater Systems. . . . .	308
<i>S.J. Perrens</i>	
Integrating Rain Water Cisterns with Public Water Supply Systems. . . . .	317
<i>Yu-Si Fok</i>	
Cistern Systems: The California Perspective . . . . .	323
<i>Alan Thane Ingham and Charles Franklyn Kleine</i>	
<b>RELATED TOPICS</b>	
✧ The Terrace-Cistern System: New Perspectives in Soil and Water Management . . . . .	332
<i>Ulpio Nascimento</i>	
✧ Underground Pipes to Recharge Rainwater Storage in Aquifers. . . . .	338
<i>Katsuyoshi Ishizaki, Fumio Yoshino, and Akira Terakawa</i>	
Rain Water Cistern Systems in China. . . . .	348
<i>Jiawiang Zheng</i>	
Water Demand Analysis for Agricultural Watersheds. . . . .	350
<i>Prabhat K. Chowdhury</i>	
Transient Mixed-Flow Models for Storm Sewer Systems. . . . .	360
<i>Charles C.S. Song and James Angus Cardle</i>	

	Flood Routing Through a Series of Detention Ponds. . . . .	368
	<i>Rong-Shun Liu and Johnny R. Barker</i>	
	Rain and Waste Water Reuse for Toilet Flushing: A Simulation Model . . . . .	377
	<i>A. Fewkes and S.A. Ferris</i>	
X	Rain Water Cistern Systems in Indonesia. . . . .	387
	<i>Srimoerni Doelhomid</i>	
	<b>AUTHOR INDEX . . . . .</b>	<b>396</b>

## FOREWORD

As I was writing the final report for my research project, "Evaluation of Roof-Cistern Systems for Residential Water Supply," supported by the U.S. Department of the Interior, Office of Water Research and Technology (Proj. No. A-073-HI), my interest in the subject continued to increase. Even before the final report was published, I was receiving letters of inquiry and answering questions on various aspects of rain water cistern (RWC) systems. Because RWC systems have regained the interest of water resources decision makers and planners as an effective alternative or supplement for an urban as well as rural water supply, I became interested in the possibility of an international conference where researchers could present their papers, followed by a workshop where ideas could be shared and problems discussed. The conference would also draw attention to and support the United Nations' General Assembly proclamation of 1981-1990 as the International Drinking Water Supply and Sanitation Decade whose goal is to provide by 1990 all people with water of safe quality and adequate quantity and with the basic sanitary facilities. I was encouraged to pursue this goal.

The International Conference of Rain Water Cistern Systems (ICORWCS) thus became a reality because of the encouragement and support of the following to whom I wish to extend my special appreciation: Dr. Ven Te Chow, to whom this proceedings is dedicated and who had strongly supported this conference and was to be our keynote speaker; Dr. S. J. Perrens, for his input and support during the initial planning stage of the conference and for his continuing encouragement throughout the program development; Dr. L. Stephen Lau, University of Hawaii at Manoa Water Resources Research Center Director, for his endorsement and support of this conference; Mrs. Faith N. Fujimura, for the editing of the conference papers; and the Office of Water Research and Technology, U.S. Department of the Interior, through the University of North Carolina, for the supporting research grant.

I wish to thank all the authors who, by responding to the call for conference papers, have contributed to the success of the conference; the Water Resources Publication Office staff, especially Mrs. Jean Nakahodo for her invaluable assistance to the conference editor in the preparation of the papers, and Miss April Kam for the graphic illustrations and for her assistance in proofreading the manuscript; and Mrs. Mary Y. Kamiya, Center for Engineering Research, College of Engineering for the printing of the proceedings.

My sincere thanks to the members of the following conference committees: Advisory Committee, for their suggestions; Organizing Committee, for their assistance in publicizing this conference; and Technical Committee, for their review of the papers and for their help in organizing the program. In addition, I wish to thank Mrs. Susan Yokouchi of the College of Continuing Education and Community Service, University of Hawaii at Manoa for the logistic support of the conference. Finally, but not least, I want to thank the sponsors, cosponsors, session chairmen, and the participants for their support and interest in this conference which was transformed from a goal into reality.

Yu-Si Fok  
*ICORWCS General Chairman*

## LESSONS OF HISTORY IN THE DESIGN AND ACCEPTANCE OF RAIN WATER CISTERN SYSTEMS

George W. Reid, Regents Professor  
School of Civil Engineering  
and Environmental Science  
Bureau of Water and Environmental  
Resources Research  
University of Oklahoma  
Norman, Oklahoma 73019, USA

Technology is the application of science to the resolution of a current problem. There are several sub-classifications, such as intermediate technology, appropriate technology, retrogressive technology. If one were to advocate the use of cisterns today, it would be retrogressive technology because in early times—about 2000 B.C.—in the Middle East (Ancient and Medieval), typical middle class dwellings stored rain water in cisterns; irrigation works were used as a domestic supply, private bathing facilities for the wealthy, and sewage and solid wastes deposited in streets and open spaces. During the 8th century, the Greeks (Olynthus) used aqueducts of terra-cotta pipes; houses with bathrooms, cisterns, lavatories, and a waste pipe running through the outside wall to the street; a central alley in each block for drainage; and covered brick masonry drains.

Hippocrates advocated boiling water for disinfection and prevention of odors, as did the Egyptians (47 B.C. Alexandria) where prominent families were provided with cisterns.

Thus, one can envision technology being applied and perfected, as required by one's environment. This leads to the conclusion that the technology used is also a function of socioeconomic conditions. Historically, most development has been associated with socioeconomic growth. The concepts of technological growth are shown in Table 1 and that of life style in Table 2. A third variable would be time (Table 3).

Now one might reflect on these ideas, first as one's life style shifts from hunting and fishing, to agriculture, industry and to mass production. One progresses (if that's the word) from rural to urban life, increased services, ultimately 70 to 80% urbanization, 70 to 75% service employment and 3 to 5% in agriculture; and develops progressively, resource strains, pollution and scarcities. Water requirements escalate from 1 to 2 l/person/day to 8000 l/person/day because of large irrigation and industrial components. Water service increase needs in the home from 7 to 8 l to 400 to 500 l/day. Eighty to 90% of the water used is contaminated, and needs treatment before recycling can occur. Thus, in successive order, water requires treatment, then is discharged as sewage, and finally is a reuse product.

As the population has increased, so have life spans. With this growth, technology also developed. The socioeconomic growth stages (I, II, III, IV) are characterized for lesser developed countries (I) to developed countries (IV).

TABLE 1. CLASSIFICATION OF WATER AND SANITATION TECHNOLOGY LEVELS

Level	Water	Sewage
I	Dug wells, springs, or rivers (local supplies); transport by water carriers Disease as result of improper handling Individual cisterns Aqueducts, canals (more distant supplies); village hydrants, fountains Disease as result of improper handling	Scavenging system for sewage and solid waste, sometimes for use as fertilizer Privy vaults, public latrines with water flushing; drainage systems; sewage farms
II	Controlled catchments Pumps, piped water, lead plumbing, fire control Typhoid, dysentery, sewage problems	Privy vaults, "close stools", some water closets; cesspools
III	Inside plumbing, slow sand filters, growth of industrial need, need for growing supply Cholera, typhoid	Water closets; combined sewers; dilution as disposal method; sewage farms
IV	Rapid filtration, chlorination, ozonation, water-softening, aeration, continued growth of industrial need Incidence of typhoid fever and other water-borne diseases decreased	Separate sewerage systems; trickling filters, activated sludge treatment
V	Rain water cisterns Fluoridation, recarbonation, advanced treatment systems, concepts of water conservation, recycling, multiple use Death from typhoid practically zero	Reuse, sewage farms
VI	Rain water in island sites	

NOTE: A detailed historic sequence (time vs. process) appears in "Appropriate Methods of Treating Water Wastewater in Developing Countries" (USAID 1977, pp. 293-315).

TABLE 2. CLASSIFICATION OF LIFE-STYLE LEVELS

Level	
I	Agricultural civilization, peasant and herdsman (the most important members of the community)
II	Balance between agriculture and hand-craft industry with a close connection to agriculture (Economically cheap and technically crude implements, most made of wood; power source irregular and often water)
III	Industrialization (Cheap and uniform implements, much use being made of iron; power source coal and steam engine)
IV	Industrialization and automation (Much use made of alloyed metals; power source often electricity)

NOTE: For a more complete description of the four levels of classification developed in the study on Appropriate Methods of Treating Water and Wastewater in Developing Countries, see the "Description of the Social-Technological Levels (STL)," p. 68 above.

A three-way reference of life style, technology (I manual, II mechanical, III chemical, IV electronic) and time are shown in Table 3. Their growth can be graphically seen in Figures 1 and 2 with an interrelationship in Figure 3. Figure suggests that, historically, the life style provides a key to an appropriate acceptable, and supportable technology.

Changing historic patterns in pollution, resources, stresses, energy costs, and dis-economies of scale all suggest a use of retrogressive technology, that is, technologies from earlier times (based on convenience, economies of scale) and abundance of cheap energy that might be acceptable today. An excellent non-water example has been the current concentration on wood and peat for fuel because of the rising cost of petroleum, environmental nuclear hazards, and still developing solar technology. Wood as an energy source lacks much of the convenience associated with electricity. Technology resources over the years developed in terms of greater convenience from wood, to peat, to char, to coal, to coke, to oil, to electricity. Cisterns present a similar potential in reduced complexity because they require no energy, nor regulation, no chemicals, and are cheap. They are adequate for reasonable water requirements and are convenient.

RAIN WATER CATCHMENT. Thus, water for domestic use may be abstracted from the hydrologic cycle at various points: as roof drainage before it reaches the ground, as ground catchment before it runs off or percolates downward, as groundwater, as spring water at the point of re-emergence to the ground surface, and as surface water from rivers and lakes. To these natural possibilities may be added man-made ones, such as abstracting water vapor from the atmosphere by condensation and creating or increasing groundwater supplies by induced or artificial recharge. Not all of these possibilities are available everywhere or at all times, and each of them has special advantages and disadvantages. Assuming an annual rainfall of 0.5 m and a roof catchment with

TABLE 3. HISTORICAL TIME SCALE, DEVELOPED REGIONS

Rome			Europe, Medieval and Modern			United States		
Life-Style Level	Technology Level	Time Span	Life-Style Level	Technology Level	Time Span	Life-Style Level	Technology Level	Time Span
I	I	750 B.C.-588 B.C.						
	II	588 B.C.-100 B.C.						
II		100 B.C.-537 A.D. (Population about one million.)						
I	I	537 A.D.-1000 A.D. (Population dwindled.)	I	I	500 A.D.-1000 A.D. (Population declined.)			
				II	1000-1600 (Cities grew.)			
			II			I	I	1600-1700 (Communities small.)
				III	1600-1800 (Industrial Revolution begins, 1750.)		II	1700-1750
						II		1750-1800 (Industrialization and growth of cities.)
			III	IV	1800-1870	III	IV	1800-1870
				V	1870-1950		V	1870-1930
			IV	VI	1950-	IV	VI	1930-



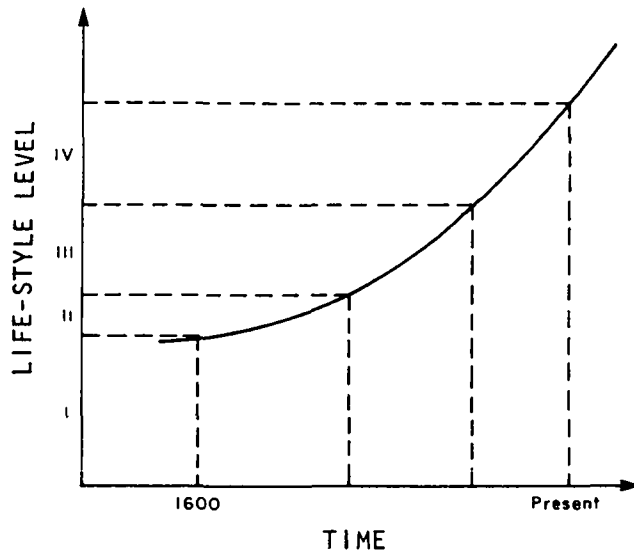

Figure 1. Technology growth in life styles I-IV, 1600 to present

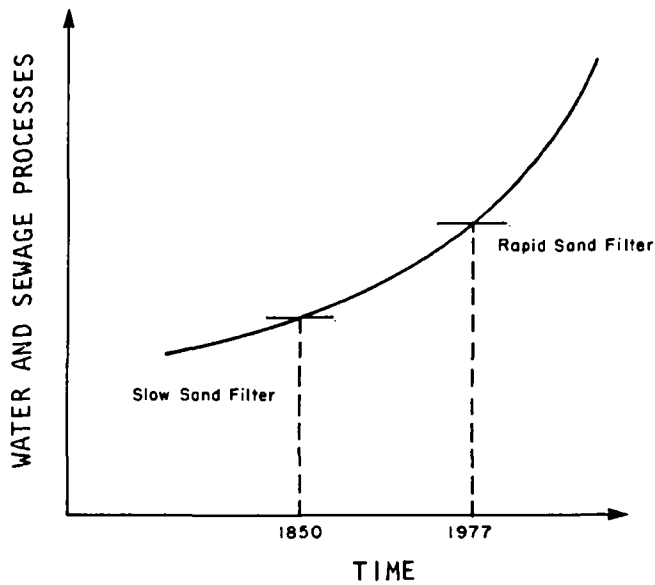

Figure 2. Technology development in water and sewage processes, 1850-1977

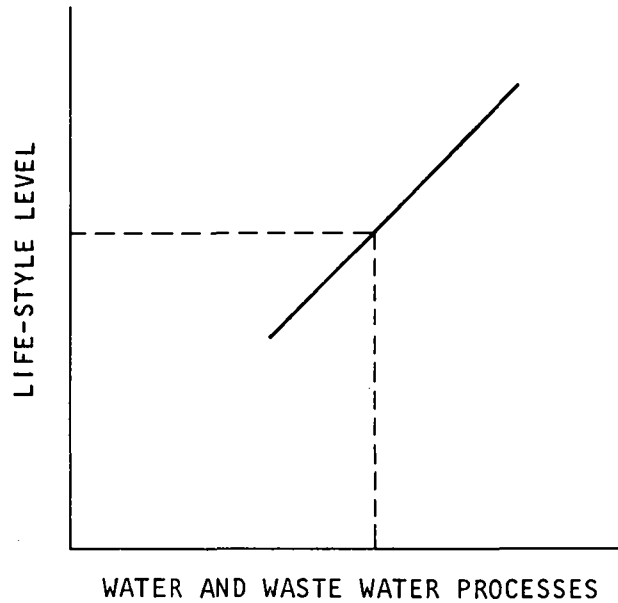

Figure 3. Relationship of life style to water and waste water processes

an efficiency of 80 to 90%, an amount of  $0.425 \text{ m}^3/\text{m}^2/\text{yr}$  becomes available. For a family of five with minimum requirements, the consumption equals 35  $\ell$ /day or  $12.8 \text{ m}^3/\text{yr}$  for which a catchment area of  $30 \text{ m}^2$  (15 x 8-ft roof) is sufficient. If the period without rain lasts for 6 months, a storage of  $6.4 \text{ m}^3$  is theoretically required. In Oklahoma, the average annual is 787.4 mm (31 in.) with 101.6 mm (4 in.) in the winter, 254.0 mm (10 in.) in spring, 228.6 mm (9 in.) in summer and 203.2 mm (8 in.) in fall. Taking into account evaporation losses, this amount must be increased to  $7.5 \text{ m}^3$ , which may be accommodated, for example, in a cistern, 2 m in diameter with a depth of 2.5 m. Often storage tanks are covered or filled with rocks or sand to reduce evaporation. When water requirements are larger, ground catchments may be used. For the same rainfall of 0.5 m/yr, an efficiency of 60 to 80% and minimum requirements of 65  $\ell$ /day, the required catchment area increases to  $68 \text{ m}^2$  and the necessary storage area to  $14 \text{ m}^3$ . In general, the size of the catchment area will provide no problems, but the necessary cistern volume is too large an effort for a single family. For small communities, filter cisterns may be applied. Rain water harvested with the help of ground catchments will always be polluted by bird droppings, by wind-blown dust, and when left unprotected, by the excrements of animals. This is the reason that cisterns equipped with sand filters are beneficial because they can produce a clear water which in many cases will also be fairly reliable, hygienically.

**CATCHMENT.** For individual households, roof catchment would be the first solution to consider, although poor roofing may call for some improvement. The quality of water supply is affected by the nature and the degree of maintenance of the catchment surfaces and the collection troughs. Rough surfaces are likely to retain wind-blown dust which is later collected by the rain water. Galvanized iron roofing provides excellent, smooth surfaces for the collection of rain water. Methods of ground catchment include alteration, or, simply, clearing the slopes of a hill of rocks and vegetation, sometimes com-

pacting the soil surface and making ditches or rock walls along hill-side contours. When erosion is not excessive, this can be a very economical solution. Another method is soil treatment. This can be the use of chemicals which fill the pores or make the soil hydrophobic, but it can also be ground stabilization with lime. This is an old technique, now scientifically approached, whereby lime is added to the soil and the soil is compacted. A third method is soil covering with waterproof membranes or asphalt layers. Sometimes the membranes have to be covered with gravel to protect them against damage by radiation, wind or cattle. There are also many different synthetic sheets.

**STORAGE.** The rain water storage tank consists in its simplest form of an oil drum and in its most complex form of a reinforced concrete cistern. Sometimes small reservoirs are used. To strain out suspended matter, sand filters may be built at the entrance of storage tanks; however, one can never rely on the safety of such water, so that disinfection will always be necessary.

**EVAPORATION.** Great losses may be experienced from evaporation during storage, particularly with the use of small reservoirs. To reduce these losses, the adaptation of monolayers of aliphatic alcohols and other liquid chemicals is a possibility. It seems to be very difficult to keep the alcohol barrier intact because of wind and water action. Furthermore, the films do not reduce the amount of solar energy which the water absorbs, and they decrease the amount of heat normally lost because inhibiting evaporation also inhibits the cooling effect of evaporation. Thus, the higher water temperature increases evaporation at any part of the water surface which the barrier does not cover. A better solution seems to be wax that softens due to the heat of sunlight and flows over the water surface to form a flexible, continuous film. The film can crack during cold weather, but the heat of the sun will reform it again. Blocks of floating and, if possible, light-colored reflecting materials have also been used with reasonable success. In the Sudan, sand-filled reservoirs have been used. The disadvantage of this system is that the required tank volume increases considerably. Another method is simply to cover the tank.

**BENEFITS.** Thus, to use this older pioneer technology, one has a system that needs less water and less convenience (energy, chemicals, etc.). It also relates to self sufficiency vs. larger integrated systems and their economies of scale.

An interesting "by-product" would relate to storm water pollution. In the continental USA, dispersed (storm water) runoff, and pollutional load are equal to that of organized (point sources).

There are numerous approaches to reducing storm water pollution, and one concept would be to totally retain the rain water on the individual residual lots and otherwise constrain it, thus reducing the flow and modifying the hydrograph in Figure 4.

These programs suggest storing all ppt in the lot, not just the roof, with a large cistern under the structure. Although never really tested, speculation indicates almost a complete reduction in water needs and a 50% reduction in hydraulic and pollution loads. Coupled with (a SCS of the city program, dams, terraces, plantings) filters reduced both hydraulic and pollutional loads—a unique, added benefit.

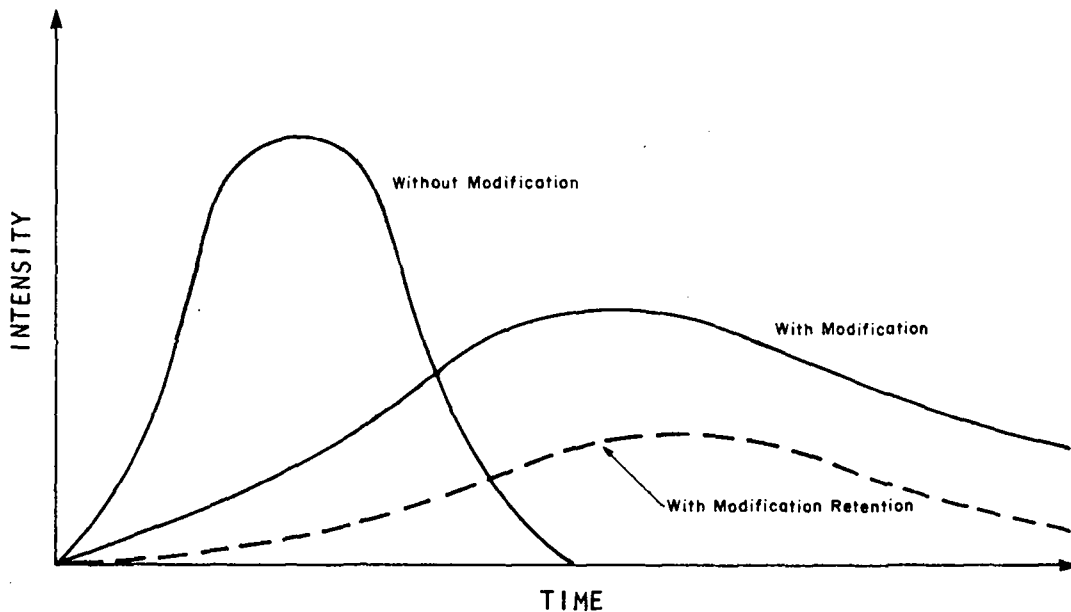

Figure 4. Hydrograph of storm water flow, with and without modification

In a larger sense, cisterns could be relied on to supply the domestic fraction of municipal water. Similarly, reuse and conservation concepts could reduce the industrial and commercial fractions. Any reduction in need is equitable to a new source. Domestic use, mostly carriage, sanitation and convenience, can, of course, be reduced by 20% if sewerless toilets or water saving toilets are used; similar reductions are possible with working modification, by reuse and cascades.

SUMMARY. Historically, cisterns or catchment areas provided simply and cheaply a safe and adequate supply for homes. Environmental conditions of life-style have, in many ways, completed the cycle, and once again these methods may be applicable in concert with storm technologies. Societies are not socioeconomically homogenous, so historically, cisterns were used in the 19th century, and kept for soft water in the 20th in cities or towns, and relied upon in water-short areas, such as Key West and the Virgin Islands. Ancient and Modern History has identified the conditions and proved the "cistern" technology.

## OUTLOOK ON ANCIENT CISTERNs IN ANATOLIA, TURKEY

Ünal Öziş, Professor  
Civil Engineering Faculty  
Ege University  
Bornova, İzmir, TURKEY

### INTRODUCTION

Evidence of human civilization in Anatolia goes back to millions of years: remains of civilization date back to the VII millenium B.C.; those of water works to the II millenium B.C. These ancient water works also included cisterns which played a certain role in water supply throughout the entire history of our country either as the only source or as an emergency water system.

Present day efforts in collecting rainfall precipitation directly into cisterns is somewhat similar to the harnessing of solar energy. Almost one-third of the solar radiation reaching the earth's crust drives the hydrological cycle and thus creates renewable fresh water and water power potential. Although actually only one-fifth of the economically feasible hydroelectric potential is exploited, with regard to spatial distributions of the water power potential and to time projections of energy needs, man actually tried to directly exploit solar energy.

Similarly, the need for fresh water in areas of scarce surface water or groundwater resources may be met by direct collection of precipitation and storage in cisterns. Besides the opportunities lying in modern mathematical methods to deal with the hydrological process involved, the physical application of this mode of water supply is thousands of years old.

In this respect, Anatolia was the crossroads of civilizations and can perhaps be considered as an open air museum of ancient water works, showing the greatest richness and variety on earth.

During the seminar session concerning ancient hydraulic works of the XVII I.A.H.R. Congress, nine contributions dealing with historical water works in Anatolia were presented (I.A.H.R. 1977); the same subject was also part of the IXIII I.A.H.R. Congress and included new contributions (Öziş et al. 1979). The author presented a key paper at the opening of the sixth T.B.T.A.K. Science Congress (Öziş 1978), a special binational symposium held in Istanbul, Turkey (Braunschweig 1979). It should be noted that the History of Hydraulic Engineering is offered as an elective course in the Civil Engineering Faculty of Ege University.

So, like all ancient water works in Anatolia, cisterns too deserve special interest. This paper is intended to provide a brief outlook on ancient cisterns in Anatolia.

### HITTITE TO EARLY ROMAN PERIODS

HITTITE PERIOD. The earliest remains of water works in Anatolia date from the Hittite period, primarily the second millenium B.C. (Öziş 1981a). Besides

Karakuyu, which is one of the oldest dams of the world (Schnitter 1979) and an outstanding spring water collection chamber near Boğazköy (Neve 1969/70), there are also remains of some cisterns from the Hittite period.

The cisterns at the acropolis of Hattusa (Boğazköy), the capital of the Hittite state, are noteworthy (Bittel 1970; Akurgal 1973). These cisterns, which date presumably from the XIV century B.C. and are excavated in rock, are apparently fed by precipitation water, which was considered as a sacred process by the Hittites (Neve 1971).

URARTU PERIOD. The Urartians developed some of the oldest water resource systems during the IX to VII centuries B.C. in east Anatolia (Garbrecht 1979). These systems include over half a dozen dams and canals with individual lengths up to over 50 km (Şamram)—most of which are still used without significant modification.

The predecessors of underground irrigation systems, which were later widely used in Iran and called Kanat systems (Biswas 1970), were also dug by the Urartians.

In spite of all these rather centralized water systems, remains of Urartian cisterns are also encountered, particularly at hill-top locations. In some cases they are combined with wells, but the main source appears to be directly collected precipitation.

#### IONIAN, PHRYGIAN, LYDIAN, LYCIAN, AND CARIAN PERIODS

During the last half of the second millenium B.C. and especially the last half of the first millenium B.C., several small states or city-state unions flourished in central, western and southern Anatolia (Akurgal 1973; Bean 1966, 1968, 1971, 1973).

Cisterns, which are mostly excavated, well-like features, were encountered at several sites. Since almost this entire area later formed a Roman province, it is not easy to identify the date of these cisterns, such as whether they belong to the archaic or to later Hellenistic or Roman periods.

#### PERSIAN, HELLENISTIC, AND EARLY ROMAN PERIODS

During 550 B.C., most of Anatolia came under the rule of the Persians, who towards 330 B.C. were defeated by Alexander the Great. After his death, some of his commanders founded small states in Anatolia and this Hellenistic age lasted until 30 B.C. when most of Anatolia became a Roman province that began with Pergamon from 133 B.C.

There exist remains of very interesting water supply systems from Hellenistic times, like those of Pergamon (Garbrecht and Holtorff 1973) and Priene (Tanrıöver 1974), that consist primarily of spring water conveyance through clay pipes.

The remains of water supply systems from early Roman times, especially from the I and II centuries A.D., belong perhaps to the most exciting examples

of ancient water systems in the world. Anatolia is an open air museum with numerous Roman water supply systems, consisting usually of rock-carved or masonry canals with high aquaducts that cross deep valleys. Among them are included the systems and conveyance lengths of Side (İzmirligil 1979) and Alabanda (Utku and Haşal 1978; Öziş et al. 1979) with over 20 km of Ephesus (Linguri, Tulgar, and Şamlı 1974; Baltalı and Büyükbeci 1977; Ersöz and Arat 1977) with over 40 km; Pergamon (Braunschweig 1975/79) with over 60 km; and Phoea (Önen, Özyurt, and Yağcı 1979) with over 90 km of the best investigated examples.

As mentioned earlier, remains of cisterns are encountered at most of the Hellenistic and Roman sites; those at Termessos, Selge, Caunos, Nysa, Hierapolis, Ephesus, and Teos being the noteworthy ones. Some of these may belong to earlier periods, and used rather as an individual emergency reservoir during later times. Others, at locations not served by the conveyance water system, remained as the principal water source in the locality.

In this respect, large cistern at Termessos, spread over several locations on the acropolis, are fine examples of masonry cisterns with vaulted roofs.

#### LATE ROMAN TO BYZANTINE PERIODS

**LATE ROMAN PERIOD.** The transfer of the Roman capital from Rome to Byzantion (thereafter called Constantinople and now Istanbul) in 330 A.D. and the split of the Roman empire in 395 A.D. into two parts led to the foundation of the Byzantine state as the eastern Roman empire. Although supplied with a fine water system extended during the middle of the IV century (Dalman 1933), the earliest interesting cisterns in Istanbul date also from this period (Eyice 1979).

In fact, rather than to supply water, this cistern (called actually Binbirdirek, because of its  $16 \times 14 = 226$  columns covering a  $64 \times 56$  m rectangular area) served as a heightening substructure for the above situated residence of the Roman Senator Philoxenus, with a maximum interior height of 14 m under the vaulted roof cover (Forchheimer and Strzygowski 1893; Mamboury 1925).

**BYZANTINE PERIOD.** Cisterns, particularly those of Istanbul, are the most remarkable water works of the Byzantine period (Yücel 1969). The first systematic investigation reported about eight covered cisterns (Andreossy 1818). The most authoritative investigation deals with 33 cisterns (Forchheimer and Strzygowski 1893); and later discoveries almost doubled this figure according to recent publications that quote 60 to 65 byzantine covered cisterns in Istanbul (Müller-Wiener 1977; Eyice 1979).

The largest covered cistern is Yerebatan, constructed during the reign of Justinian during the middle of the VI century. Covering a rectangular area of  $140 \times 70$  m, the roof rests on  $12 \times 28 = 336$  columns with a height of 8 m (Wiegand and Mamboury 1934). This cistern was fed by the Kırkçeşmeler conveyance system and served as seasonal regulation reservoir.

Some of the other cisterns served the same purpose; others served as a substructure to level off the topography and/or heighten the main building. However, especially after the invasions by Avars and other people during the

VII and VIII centuries and destruction of the water conveyance systems outside the fortification walls, cisterns fed from precipitation became the major source of water supply. In some cases, cellars were improvised into cisterns. Almost all these cisterns are colonnaded structures that are covered with vaulted roofs, some of them dating even as late as the XIII century (Forchheimer and Strzygowski 1893; Eyice 1979).

There are also some open-air pool-like cisterns in Istanbul dating from the V century. The cistern of Aetius (near Edirnekapı) covers a 244 x 85 m rectangular area with a depth of 13 m; that of Aspar (near Sultanselim), a 152 x 152 m square area with a depth of 11 m; that of Mokios (near Altimermer), a 170 x 147 m rectangular area with a depth of 11 m; and a fourth called Filhane (near Bakırköy) that dates probably from the VIII century and covers a 127 x 76 m area with a depth of 11 m (Forchheimer and Strzygowski 1893; Mamboury 1925; Eyice 1979).

These cisterns along with the covered ones create a seasonal regulation volume of about 1 000 000 m<sup>3</sup>, which is fairly large when compared to XIX century European cities (Forchheimer and Strzygowski 1893). This also explains the misleading quotation in some old literature that the ancient dams of Istanbul date from the Byzantine period (Forchheimer and Strzygowski 1893; Mamboury 1925), whereas, they completely belong to the Ottoman period and constructed during 1620 to 1839 (Dalman 1933; Çeçen 1979; Öziş 1981b).

#### SELJUK AND OTTOMAN TURKISH PERIODS

After the fall of Byzance in 1453, Sultan Mehmet the Conqueror extensively repaired the Halkalı conveyance system of Istanbul. A century later under the reign of Sultan Süleyman the Magnificent, the Great Architect Sinan almost completely rebuilt the Kırkçeşmeler conveyance system; a third large conveyance system, Taksim, was added during the XVIII century (Dalman 1933, Çeçen 1979).

With regard to these centralized water systems, the role of cisterns in Istanbul decreased, but continued in remote areas not served by them. The same happened in other parts of the country.

A very interesting cistern type emerged in this period in rural areas. Contrary to the rectangular plan of byzantine cisterns, these are circular in shape. A large part of these cisterns found in south-west Anatolia date from the XVI century, and served military logistic purposes of the Ottoman army. They are about 7 m diameter structures, having a domed roof with a height about one third of the diameter on a superstructure 1 to 2 m high and a substructure a few meters in depth, with stairs descending to the bottom of the cistern. Most of them are still in use for livestock water supply.

#### CONCLUSION

Remains of cisterns, dating from the last three to four thousands of years, are encountered in Anatolia. However, all of them were not intended to collect precipitation water and serve as the major source of water supply. In some cases they served for seasonal regulation of water brought by large conveyance systems; in other cases, they served primarily as substructures to



level off the topography for the foundation of buildings and/or to provide additional height to them.

Cisterns were especially the basic water supply elements in elevated locations of most ancient cities and as emergency solutions in case of warfare. Furthermore, they were and still are used in rural areas in small towns of Turkey where the urban water supply systems are insufficient or water is scarce.

The fast growing population and the even faster growing socioeconomic development in economically developing countries impose a heavy need on water supply. The application of modern hydrologic and construction techniques for cisterns deserves special interest since they may still play a significant part in scattered and small populated areas of these countries.

The cisterns of Anatolia quoted in this paper, though far from being a complete review, may serve as a source of inspiration for modern applications of cisterns.

#### REFERENCES

- Akurgal, E. 1973. *Ancient civilizations and ruins of Turkey*. Istanbul: Haşet, 3.ed., 390 p., 112 pl.
- Andreossy, C. 1818. *Voyage à l'embouchure de la Mer Noire*. Paris, France.
- Baltalı, D., and Büyükbeci, M. 1977. *Antik Efes şehrinin güney kaptajı (Kuşadası yönü)* (Southern water supply of the antique city Ephesus: Kusadası direction). İzmir, Ege Üniversitesi, Mühendislik Bilimleri Fakültesi, İnşaat Mühendisliği Bölümü, Diploma Çalışması (Yön.: T. Acatay).
- Bean, G.E. 1966. *Aegean Turkey*. London: Benn. 288 p.
- Bean, G.E. 1968. *Turkey's southern shore*. London: Benn. 188 p.
- Bean, G.E. 1971. *Turkey beyond the maeander*. London: Benn. 267 p.
- Bean, G.E. 1978. *Lycian Turkey*. London: Benn. 197 p.
- Biswas, A.S. 1970. *History of hydrology*. Amsterdam, North Holland, 336 p.
- Bittel, K. 1970. *Hattusa, the capital of the Hittites*. New York: Oxford University Press.
- Braunschweig, T.U. 1975/1979. *Leichtweiss-Institut für Wasserbau, Mitteilungen*. Braunschweig: Technische Universität, H.44, 45, 54, 60, 61, 64 (by G. Garbrecht, H. Fahlbusch, K. Hecht, H. Kalweit).
- Braunschweig, T.U. 1979. *Istanbul İ.T.Ü. Symposium über historische Wasserversorgungsanlagen*. Braunschweig, Technische Universität, Leichtweiss-Institut für Wasserbau, Mitteilungen, H. 64.

- Çeçen, K. 1979. Osmanische Wasserbauten in Istanbul. Braunschweig. Technische Universität, *Leichtweiss-Institut für Wasserbau, Mitteilungen*, H.64.
- Dalman, K.O. 1933. *Der Valens-Aquädukt in Konstantinopel*. Bamberg, Archäologisches Institut des Deutschen Reiches, *Istanbuler Forschungen*, Bd.III.
- Ersöz, H., and Arat, E. 1977. *Antik Efes şehrinin Belevi kaptajları* (Bekis water supplies of the ancient city of Ephesus). Ege Üniversitesi, Mühendislik Bilimleri Fakültesi, İnşaat Mühendisliği Bölümü, Diploma Çalışması (Yön.: T. Acatay).
- Eyice, S. 1979. Byzantinische Wasserversorgungsanlagen in Istanbul. Braunschweig: Technische Universität, *Leichtweiss-Institut für Wasserbau, Mitteilungen*, H.64.
- Forchheimer, P., and Strzygowski, J. 1893. *Die byzantinischen Wasserbehälter von Konstantinopel*. Wien, Beiträge zur Geschichte der byzantinischen Baukunst und zur topographie von Konstantinopel, 270 p.
- Garbrecht, G. 1979. Urartäische Wasserversorgungsanlagen im Bereich des Van Sees. Braunschweig: Technische Universität, *Leichtweiss-Institut für Wasserbau, Mitteilungen*, H.64.
- Garbrecht, G., and Holtorff, G. 1973. Wasserwirtschaftliche Anlagen des antiken Pergamon: Die Madradağleitung. Braunschweig: Technische Universität, *Leichtweiss-Institut für Wasserbau, Mitteilungen*, H.37, 100 p.
- I.A.H.R. 1977. *XVII Congress Proceedings*. (Papers by Omay, Öziş, G. Garbrecht, Brinker, Fahlbusch, Friedel, Schmidt, Gieger, J. Garbrecht.) Baden-Baden 6:740-743; 747-780.
- İzmirilgil, Ü. 1979. Die Wasserversorgungsanlagen von Side. Braunschweig: Technische Universität, *Leichtweiss-Institut für Wasserbau, Mitteilungen*, H. 64.
- Linguri, M.; Tulgar, T.; and Şamlı, F. 1974. *Antik Efes şehri su getirme ve kanalizasyonu* (Water supply and sewerage of the ancient city of Ephesus). İzmir, Ege Üniversitesi, Mühendislik ve Mimarlık Yüksek Okulu, Diploma Çalışması (Yön.: T. Acatay).
- Mamboury, E. 1925. *Constantinople*. Istanbul, Rizzo, 565 p.
- Müller-Wiener, W. 1977. *Bildlexikon zur topographie Istanbuls*. Tübingen, pp. 271-285.
- Neve, P. 1969/70. Eine hethitische Quellgrotte in Boğazöy. Tübingen: *Istanbuler Mitteilungen* XIX/XX:97-107.
- Neve, P. 1971. Regenkult-Anlagen in Boğazköy-Hattusa, ein Deutungsversuch. Tübingen: *Istanbuler Mitteilungen* Beiheft V.
- Önen, N.; Özyurt, S.; and Yağcı, G. 1979. *Foça tarihsel su iletimi* (Historical water conveyance to Foça). İzmir, Ege Üniversitesi, İnşaat Fakültesi, İnşaat Mühendisliği Bölümü, Hidroloji ve Su Yapıları Diploma Çalışması,

n.43 (Yön. Ü. Öziş, O. Baykan).

- Öziş, Ü. 1978. Su mühendisliği tarihi açısından Anadoludaki eski su yapıları (Ancient water works in Anatolia with regard to hydraulic engineering history). In *VI Bilim Kongresi, Mühendislik Araştırma Grubu Tebliğleri*, T.B.T.A.K., Ankara, no. 384/MAG-49, pp. 1-21.
- Öziş, Ü. 1981a. Anadoluda su kaynaklarının geliştirilmesinin dünü, bugünü, yarını (Yesterday, today, tomorrow of water resources development in Anatolia). In *Su ve Toprak Kaynaklarının Geliştirilmesi Ulusal Konferansı* (National Conference on Water and Land Resources Development), R.1, Activities for the Centenary of Atatürk's birth, D.S.I. (State Hydraulic Works), Anakar, 26-28 May 1981 (in press).
- Öziş, Ü. 1981b. The ancient dams of Istanbul within the perspective of dam technology history. In *I Congress on the History of Turkish-Islamic Science and Technology Proceedings*, Istanbul Technical University, Istanbul, 14-18 September 1981 (in press).
- Öziş, Ü.; Atalay, A.; Haşal, M.; and Atalay, V. 1979. Antike Fernwasserleitungen von Alabanda und Gerga. Braunschweig: Technische Universität, *Leichtweiss-Institut für Wasserbau, Mitteilungen*, H.64.
- Öziş, Ü.; Harmancıoğlu, N.; Baykan, O.; Ünal, Ş.; and Tolkun, N. 1979. Flood flows and capacities of the historical Pergamon and Nysa tunnels in Anatolia. In *I.A.H.R. XVIII Congress Proceedings*, Cagliari.
- Schnitter, N. 1979. Antike Talsperren in Anatolien. Braunschweig: Technische Universität, *Leichtweiss-Institut für Wasserbau, Mitteilungen*, H.64.
- Tanrıöver, A. 1974. *Prienedeki tarihi su yapıları* (Historical water works in Priene). İzmir, Ege Üniversitesi, Mühendislik Bilimleri Fakültesi, Hidroloji ve Su Yapıları Diploma Çalışması, No. 23 (Yön.: Ü. Öziş).
- Utku, V., and Haşal, M. 1978. *Alabanda ve Gerga tarihi su iletim sistemleri* (Historical water Conveyance systems of Alabanda and Gerga). İzmir, Ege Üniversitesi, Mühendislik Bilimleri Fakültesi, Hidroloji ve Su Yapıları Diploma Çalışması No. 37 (Yön.: Ü. Öziş ve A. Atalay).
- Wiegand, T., and Mamboury, E. 1934. *Die Kaiserpaläste von Konstantinopel*. Berlin, Germany, pp. 54-71.
- Yücel, E. 1967. Istanbul'da Bizans sarnıcları. *Arkitekt, Istanbul* 325:16-20; 326:62.

## HISTORY OF YUCATÁN CISTERNs

Tucheé Gordillo, Researcher  
 Department of Hydrology  
 Faculty of Civil Engineering  
 University of Yucatán  
 P.O. Box B-1423  
 Mérida, Yucatán, MÉXICO

Ernesto González L., Researcher  
 Centro Regional del Sureste del  
 Instituto Regional de Antropología  
 e Historia  
 Ap. Postal 1015, Mérida, Yucatán,  
 MÉXICO

Salvador Gaona V., Professor<sup>1</sup>  
 Institute of Physics  
 Universidad Nacional Autónoma de México  
 México 20-364 D.F., MÉXICO

## INTRODUCTION

The development of civilizations is always associated with sources of fresh water—the more usual sources being natural rivers or lakes. In some cases, the state of technical development permits the settlement of cities where only rain water is available. The systems constructed to collect and store rain water are historically the oldest hydraulic works. This system is practiced all over the world under the same principles: a catchment area that collects rain water, a transport system that conducts the collected water and a storage vessel where the water remains until needed. The differences vary according to the type of material, ecological/economic conditions and the state of the architecture or design. Here is a brief presentation of the ways developed by the Yucatecans settled in the Peninsula of Yucatán—the Mayas and modern inhabitants. The observations and data were obtained from different studies and direct observations and measurements of the authors. The presentation covers the beginning of the classical Maya period (300 A.D.) to the present.

## STUDY AREA

The peninsula of Yucatán is located in the eastern part of México, surrounded to the north and west by the Gulf of México and to the east by the Caribbean Sea (Fig. 1); to the south are Guatemala and Belice. The peninsula is made up of Tertiary and Quaternary calcareous sediments that form a plain at the north and a plateau at the south. This plain rises from sea level along the coast to slightly more than 30 m above sea level inland. A low hill (Sierrita de Ticul), from which the plain starts, is 150 m above sea level. Neither lakes nor rivers are present in the peninsula. Soil is very sparse and the intercalating layers of limestone and saskab (Isphording 1974) are highly porous and permeable, thus absorbing the rainfall. The mean annual temperature is 26.5°C, with 8°C in winter and 40°C in summer. The relative average humidity is 50% and the rainfall is 967 mm. The dry season includes the months of November to April.

<sup>1</sup>Presently, member of a cooperative program at the Dept. of Hydrology, University of Yucatán, México.

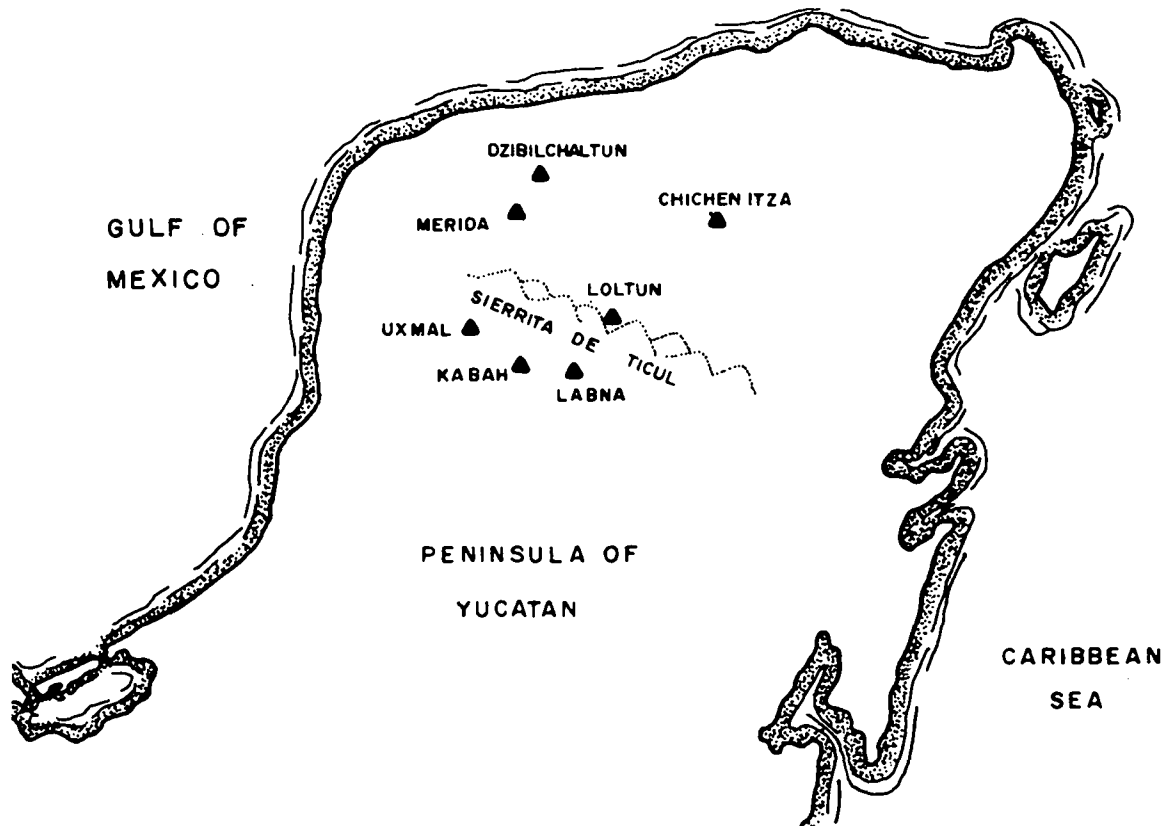
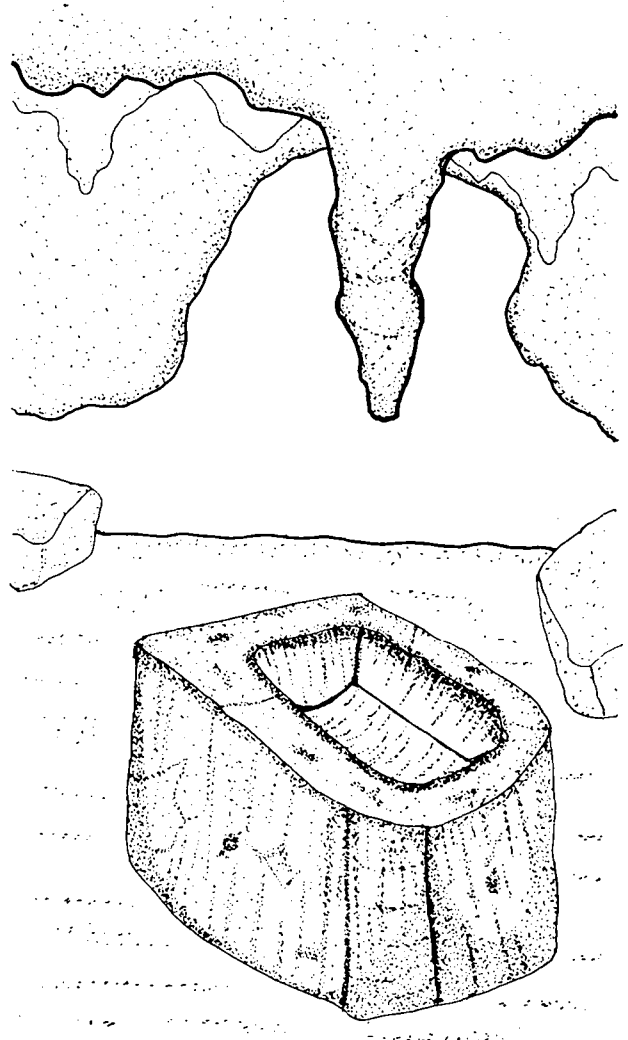

Figure 1. Location of the studied area

#### RAINWATER SYSTEM IN YUCATÁN

The Yucatán region is known as the cradle for one of the most important cultures of the continent. The development and settlement of cities at the northern part of the peninsula, for example, Dzibilchaltun and Chichen-Itza, were closely related with sources of fresh water wells called *cenotes* (Gaona, Gordillo, and Villasuso 1981), which are karstical manifestations of this region (Fig. 2). At the south of the peninsula, the depth of the water table increases as the terrain rises in elevation. The *cenotes* have been replaced by cavern system that make it more difficult to reach the water. To solve their water needs, the Mayas had to develop different catchment and storage systems for rain water.

The more primitive system consisted of collecting water dripping from the stalactites in caverns in stone containers called *haltunes* (Fig. 3). After a long incursion through the caves, however, only a few liters could be obtained from each collection, and this *zuhuy ha* (virgin water) was used mainly in ritual ceremonies. Water was also caught from the cavern ceilings in clay vessels. Because carrying out the vessels was difficult through the small tunnels and along slippery floors, very often the vessels were dropped as evidenced by the great amount of pottery shards. To increase the amount of available water, these people developed *akalches* which are natural depressions in rock surfaces that were cleaned and made impermeable with stucco plastering.

Figure 2. *Cenote*Figure 3. *Haltun*

These systems are frequently found in Uxmal, Labna and Kabah. Mercer (1975), Stephens (1963) and Gonzalez (1979) have presented detailed descriptions of the locations and characteristics of these types of systems. The stucco, which was also used to waterproof floors and walls, was made with shell or powdered limestone, fired in huge pyres for several days, and then after the pieces of wood were removed, the mineral and ashes were mixed with water and applied to the surface.

However, the *haltunes* and *akalches* did not solve the water supply problem, which got worse as the population increased. The Mayas constructed new hydrau-

lic works called *chultunes*, which were classified in three different ways: those associated with geological strata, those related with public buildings and those with *akalches*.

It is possible but not certain that in the first attempt the volume of the *akalches* was increased by digging reservoirs with bottle-like forms under the *akalches* (Fig. 4). This type of *akalche* served as a container and catchment area, and an example can be found in the rancho Jalal in Yucatán.

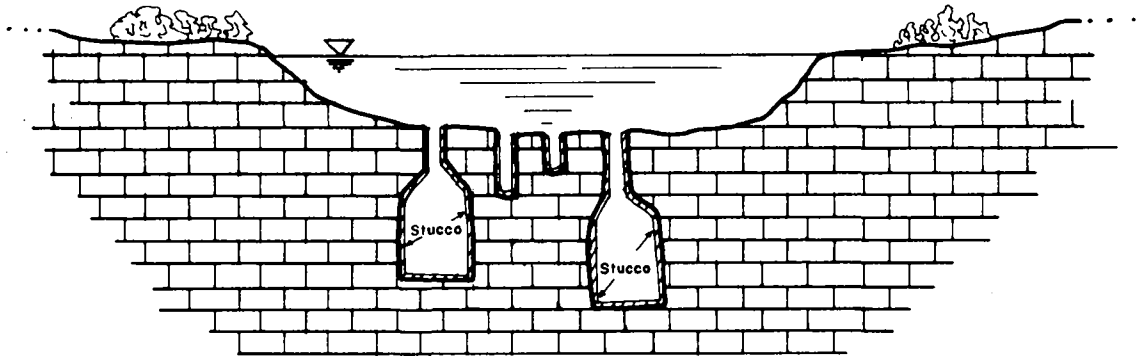
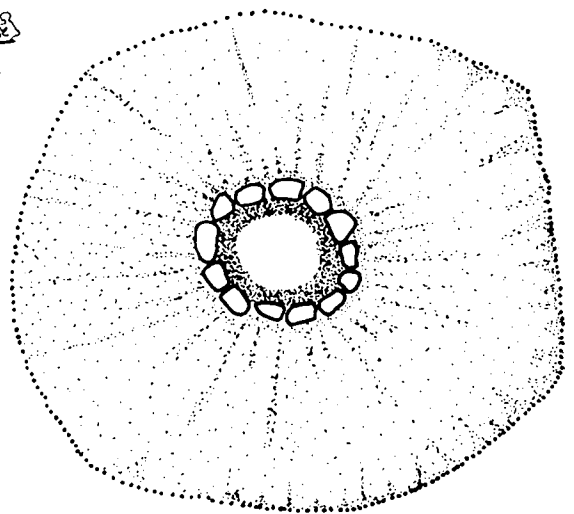
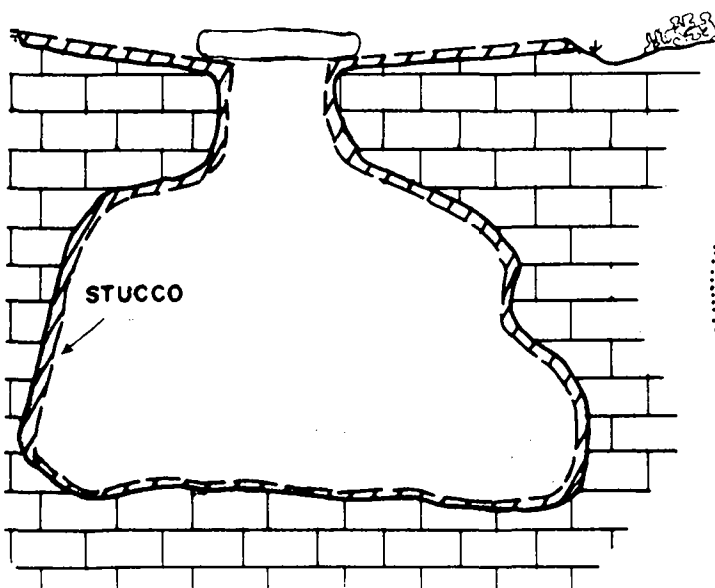

Figure 4. *Akalche* with *chultunes*

Where *akalches* were not available where water was needed, *chultunes* and the catchment area were constructed in places where limestone (just a few centimeters thick) was underlaid by saskab. The limestone was drilled and the shell removed until the cavity had a bell-jar form, unless because of the geologic formation, only irregular shapes were made (Fig. 5). The cavities were covered with a thin coat of stucco and decorated with aquatic motifs and some with anthropomorphic representations.

CROSS SECTION



PLAN VIEW

Figure 5. *Chultun*

The catchment area of these systems were terraces or circular waterproof sections sloped so that the water could drain into the *chultun*. When public buildings or palaces were constructed, the mounds were leveled; from that moment, *chultunes* were built to take advantage of the construction of covered arches or vault mayas (Andrews 1975). Depending on the configuration of the architecture, water was either partially or totally caught in cistern; and where buildings did not exist, any hillside served as a catchment area for *chultunes* excavated at its base. During the rainy season, stone slabs were placed at the mouth of the *chultun* to prevent the entrance of foreign material; in the dry season, the *chultunes* were covered and sealed with a carved limestone block. Baltazar González (1979) has described some of these which are located in Uxmal, and Morley (1956) has mentioned that one of them has an approximate 10 000-ℓ capacity. Typical depths of these systems are from 3 to 6 m, with diameters of 5 to 7 m. Today, some of these *chultunes* are still in use.

In colonial times, the Spaniards dug wells. It was because of the hardness of water and, perhaps its contamination, that from the Henequen's Haciendas (Sisal) time, systems known as *aljibes* (cisterns) were developed. These underground *aljibes* were of enormous capacity—storing 25 000 ℓ of rain water caught on the roof and piped to the main house. It is possible to visit haciendas with these systems, some which are very artistically decorated. Water for human needs, other than drinking, was withdrawn from dug wells until 1965 when water supply systems were installed.

After the Mexican Revolution, houses were constructed and the water supply systems of the haciendas were adopted. In modest houses, the underground systems were substituted with surface-level tanks that were first made of iron, and later of concrete. These 3 m mean diameter, 2.5 m high tanks had two drains, one at the bottom for cleaning and another a few centimeters from the bottom for withdrawal. A metallic grid was placed at the catchment surface to serve as a filter; another filter to which some people added lime, sulfur or chlorine, was placed at the water tap to purify the water.

At the end of the dry season, the Yucatan swept and washed their roofs and tanks or cisterns. Sometimes they also applied a whitewash of pure lime. Water from the first rain was not collected but was used to clean the roofs and to flush the piping for the system. By means of a valve, the water used for cleaning was deflected, thus preventing its entrance into the cistern. Sometimes when the water from the year before was mixed with the new, biological processes were accelerated and the water acquired a disagreeable odor, which was removed by boiling. Such a process was not usual and only applied under those circumstances when gastrointestinal diseases were prevalent.

The potable water system construction was initiated in 1905 in the city of Mérida. However, some people still use rainwater catchment as a source of fresh water because of the high ion content. In Table 1, it can be seen that the water quality values of water stored in cisterns (column 2) have a higher dissolved ion content than the container and catchment areas.

From this presentation, it can be seen that rain water played a very important part in the development of the Mayan culture and in the lives of the present inhabitants of the Yucatán Peninsula. From the results also presented at this conference by Vega and Gaona, the future role of water will be the



TABLE 1. WATER QUALITIES, MÉRIDA

PARAMETERS	WATER QUALITY AVERAGE		
	Rainfall	Cisterns	Potable Water
	----- (mg/l) -----		
pH	7.12	8.37	7.36
Conductivity, micromhos	121.80	244.00	1076.00
Hardness (CaCO <sub>3</sub> )	76.36	164.10	425.00
Hardness of Calcium	36.52	99.25	242.40
Hardness of Magnesium	39.84	64.85	183.50
Alkalinity (HCO <sub>3</sub> <sup>-</sup> )	60.12	99.90	336.10
Calcium	14.52	39.70	96.97
Magnesium	9.89	15.74	44.59
Sulfate	2.85	4.45	42.00
Chloride	3.29	14.03	202.00
Sodium	0.00	2.30	108.82
Potassium	0.00	1.95	9.12
Nitrate Nitrogen	0.39	1.33	----
Phosphate	0.02	----	----
Acidity	5.25	----	----

same. What seems to be important is that more research work must be done from the sanitary and constructive point of view to prevent water-related diseases.

#### ACKNOWLEDGMENTS

We wish to thank Miguel López Lugo and Gaspar Mejía for their valuable comments and contributions to this paper. In addition, we want to express our appreciation to Jaime Barrera, Alvaro Mimenza and Carlos L. Tamayo for their historical information, and Julia Pacheco for the chemical analyses. Our thanks also to Patty Bush for the review of the manuscript and to Rosa Méndez for the typing of the original draft.

This work was supported by a grant from the Dirección General de Investigación Científica y Superación Académica of the Secretaría de Educación Pública, México.

REFERENCES

- Andrews, G.F. 1975. *Maya cities*. Norman: University of Oklahoma Press.
- Gaona, V.S.; Gordillo, de A.T.; and Villasuso, P.M. 1981. "Cenotes Karst caracteristico: Mecanismos de formacion." Submitted to *Revista Instituto de Geologia, Universidad Autonoma de Mexico, México*.
- González, B. 1979. Los chultunes de Uxmal. In *I Congreso Interno del Centro Regional del Sureste del Instituto Nacional de Antropología e Historia*. Mérida, Yucatán, México. (In Press)
- González, L.E. 1980. Proyecto Loltun, temporada 1980. In *II Congreso Interno del Centro Regional del Sureste del Instituto Nacional de Antropología e Historia*. Mérida, Yucatán, México. (In Press)
- Isphording, W.C. 1974. Weathering of Yucatan limestone: The genesis of Terra Rosas. In *Annual Meeting of the Geological Society of America*, pp. 77-93, New Orleans Geological Society, at Miami, Florida, 1974.
- Mercer, H.C. 1975. *The hill-caves of Yucatan*. Norman: University of Oklahoma Press.
- Morley, S.G. 1972. *La civilizacion Maya*. México: Fondo de Cultura Economica.
- Stephens, J.L. 1963. *Incidents of travel in Yucatan*. New York: Dover. Volumes 1 and 2.

# PRESENT AND PAST DEVELOPMENT OF CATCHMENT AREAS IN THE MEDITERRANEAN COASTAL DESERT OF EGYPT

Abdu A. Shata  
Professor of Hydrogeology  
Desert Institute  
Cairo, EGYPT

## INTRODUCTION

The Mediterranean Coastal Desert of Egypt comprises a narrow zone having an east-west length of about 1 000 km and a north-south width of about 20 km. This coastal desert, located between the Cyrenaican Massif (+700 m) to the west and the Negev-Lebanon Massif (+2 000 m) to the east, occupies a portion of the great Sahara Desert of Africa and extends northward to the Mediterranean Sea (Fig. 1). The climate of this coastal desert differs from the inland desert areas to the south, and is characterized by winter rainfall of 150 to 300 mm frequent and comparatively high periods of humidity, and small diurnal temperature variations.

This paper deals with the western portion of the coastal area, which is historically known as the Mareotis District. The district extends westward to the Libyan border and was once an area of prosperous cultivation. But by the 10th century, the area gradually declined and changed into an almost desert tract. As discussed by Kassas (1972), it is "unlikely that there have been major climatic changes during the last 2000 years that could have caused the deterioration of this area." Facts obtained from the work carried out in connection with the dating of groundwater using carbon 14 techniques (Shata et al.

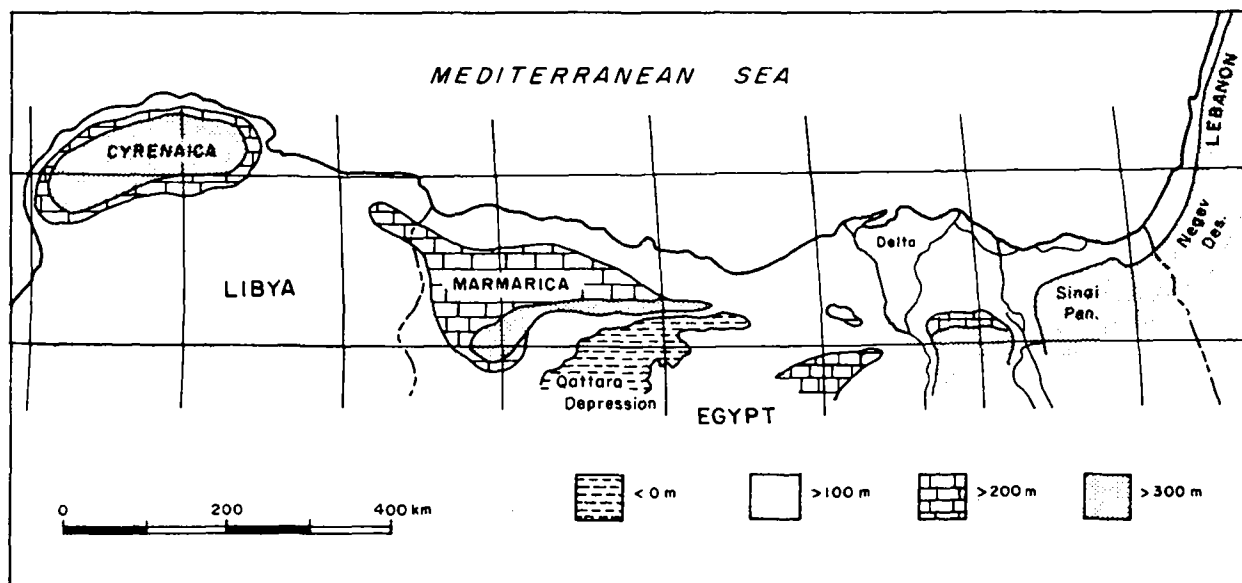

Figure 1. Geographical location

1962) support this conclusion and show that the last rainy interval coincided with the "Late Würme" some 7000 years before. The coastal area "must have depended for its cultivation on dry farming that included methods of water management and conservation."

In this paper on the development of catchment areas, emphasis will be given to the following two methods used since Roman times in the Mediterranean Coastal Desert area: (1) cisterns and (2) Karms or vineyards. Before describing the details of such systems based on personal experiences and on information available in the literature (Hume and Hughes 1921; De Cosson 1935; Shafie 1952; Paver and Pretorius 1954; Murray 1955; Kassas 1972), the physiographic features and the water resources of the area will be discussed.

### PHYSIOGRAPHIC FEATURES

The western Mediterranean Coastal Desert occupies the northern extremity of a rocky platform characterized by fairly regular surface relief that includes the following principal topographic features.

1. A low coastal plain with elevations rarely exceeding +50 m. This plain that extends in an east-west direction is characterized by a number of undulations corresponding to headlands protruding into the sea and to short embayments and gulfs. The surface of the coastal plain is marked by elongated ridges running parallel to the present Mediterranean coast. Such ridges mark the position of the receding coast during Quaternary times, and alternate with lagoonal depressions filled with calcareous loamy deposits. In the depressions where the surface is near sea level, the loamy deposits become inundated with salt water, and marshy areas or lagoonal lakes or both are formed. Thus, the elongated ridges serve as watershed areas for rain water and the depressions as ponding areas. The width of the coastal plain exceeds 10 km in some places and narrows to a few meters in others.
2. A calcareous plateau bounding the coastal plain on the southern side. This plateau is homoclinal, rises about 100 m above the coastal plain, and is generally separated by an escarpment to the north. The transition from the coastal plain to the plateau area is gradual and is marked by gentle slopes of 1 to 5 degrees (Fig. 2).

### WATER RESOURCES

The western Mediterranean Coastal Desert depends essentially on local rainfall (Fig. 3; Tables 1, 2) for its water supply. Based on an average annual rainfall of 100 mm, the amount of water falling on the surface of this desert area of 10 000 km<sup>2</sup> is on the order of one billion cubic meters—an amount considered low by international standards and also "variable between locations within the year and between years." However, if the better conservation and management techniques of the past were used, this amount of rainfall would add to the water supply of the area and, consequently, to the reclamation and development of this coastal desert which is suffering from continuing desertic processes.

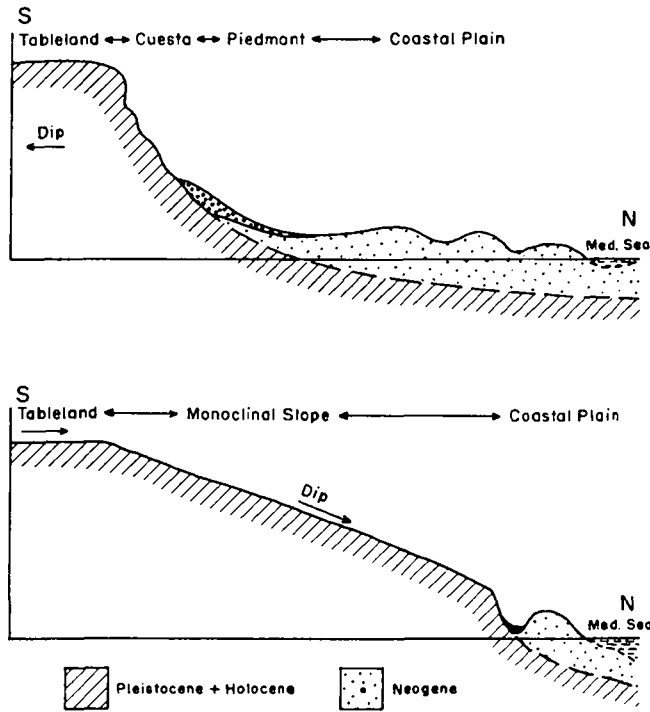

Figure 2. Types of slopes

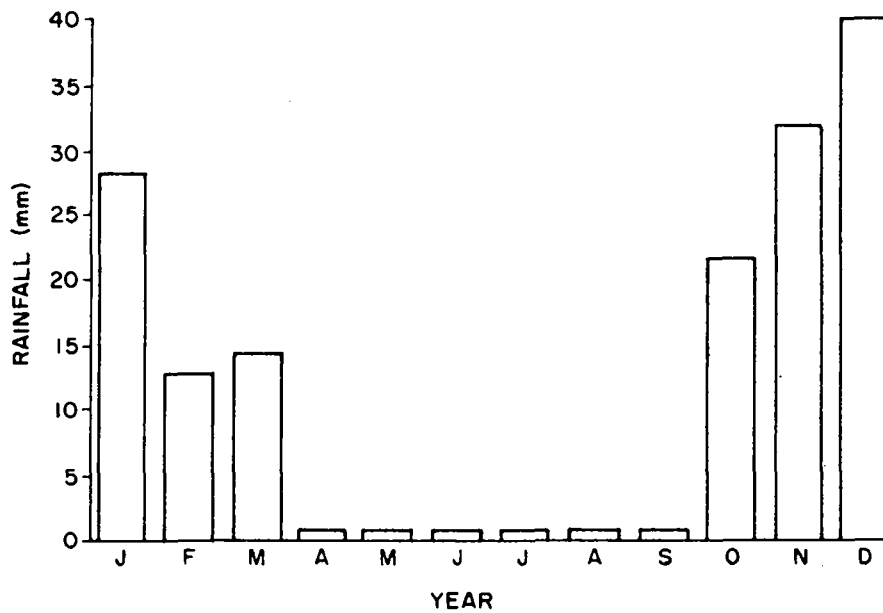

Figure 3. Mean monthly rainfall distribution

TABLE 1. AVERAGE MONTHLY AND ANNUAL RAINFALL, 1925-1939, 1951-1965, MAREOTIS DISTRICT, EGYPT

STATION	MONTHLY RAINFALL												ANNUAL RAINFALL (mm)
	Jan.	Feb.	Mar.	Apr.	May	June	July	Aug.	Sept.	Oct.	Nov.	Dec.	
	----- (mm) -----												
Alexandria	46.4	27.3	8.9	3.0	1.7	0.0	---	0.0	0.5	7.8	33.4	57.6	180.6
Burg-El-Arab	42.1	22.1	4.7	4.1	0.6	0.0	---	0.0	0.4	13.7	31.4	35.5	156.6
El-Hammam	28.5	18.7	5.3	1.5	0.5	0.0	---	0.0	3.1	8.9	25.1	28.3	119.9
El Dab'a	32.6	18.1	9.2	2.6	2.6	0.0	---	0.3	1.0	8.1	29.3	36.8	140.6
Fuka	21.8	18.5	4.8	1.0	1.5	0.0	---	0.0	0.8	11.7	19.1	29.2	108.4
Mersa Matruh	36.4	20.3	10.3	3.8	2.2	1.9	---	0.5	0.9	12.1	23.6	35.6	147.6
Sidi Barrani	38.1	19.4	10.2	1.6	2.8	0.1	---	0.1	0.3	14.4	21.9	35.0	143.9
Salum	21.3	15.8	8.2	1.3	2.8	0.0	---	0.5	0.1	7.9	19.8	24.5	102.2

TABLE 2. MEAN NUMBER OF RAINY DAYS, 1957-1965  
MAREOTIS DISTRICT, EGYPT

STATION	RAINY DAYS			
	R 0.1	R 1	R 5	R 10
	----- (mm) -----			
Alexandria	47.7	30.2	11.7	5.2
Dab'a	24.6	17.1	8.0	4.0
Mersa Matruh	41.9	23.1	7.3	3.1
Sidi Barrani	40.2	25.1	8.7	3.8
Salum	31.7	14.1	5.2	2.2

Of this amount of water, 100 million cubic meters is accounted for as surface runoff from the plateau area and the coastal ridges. The major portion of the surface runoff is lost to the sea and to coastal depressions. The surface runoff depends on a number of factors which include the shape of the hydro-graphic basins, the elevation, the soil cover and thickness, and the slope. In the coastal desert area, the infiltration amount of rain water into the rock is on the order of 40% (Paver and Pretorius 1954), or an amount of 300 million cubic meters of water that infiltrates pore spaces and fissures. Only 50% of this amount (150 million m<sup>3</sup>) is expected to reach the groundwater tables.

In this area, the normal water table occurs at sea level where there is a dynamic equilibrium between a thin layer of fresh water in the upper surface of the salt water resulting from the inflow of sea water. Vertical wells, known locally as Sawani, are dug by hand to perched water tables which are developed particularly where the geologic structure and/or facies are favorable.

#### DEVELOPMENT OF CATCHMENT AREAS

In the Mediterranean Coastal Desert area, there are two types of catchment areas: (1) local catchment areas located within the ridges of the coastal plain and (2) regional catchment areas located within the calcareous plateau.

The coastal ridges, rising to +35 m, run generally in an east-west direction, and its surface slopes both to the north and to the south. In the eastern portion of the coastal plain, such ridges can be followed for more than 100 km. The width of the ridges varies from about 1 km to less than half a kilometer. The summits are either barren rocks or covered with dune sand accumulations. Incised by short and shallow runnels, the slopes are covered with a thin mantle of down-wash deposits composed of calcareous silt and stone fragments.

The rain water which falls on the ridges continues down the slopes and into depressions at the foot of the slopes. Along the slopes are scattered evidences of attempts to conserve runoff water. These attempts consist essentially of the construction of cistern and Karms (vineyards). However, the cisterns are mostly clogged with silt and the Karms destroyed by gully erosion.

The calcareous plateau, forming the regional catchment area, occupies almost all of the southern portion of the coastal plain and terminates generally to the north with an escarpment. The rain falling on this catchment area is generally directed northward and accounts for the development of outwash channels (about 218 in number)—of which a good number discharge into the sea.

Present and past efforts in water conservation within the plateau area include the following:

1. Spreading water along well-defined outwash channels
2. Damming the water and forming artificial lakes
3. Storing the water in underground chambers known as cisterns and in surface basins known as Karms.

This paper deals only with cisterns and Karms used to conserve water in the Mediterranean Coastal Desert areas.

## CISTERNS

Along the western Mediterranean Coastal Desert, the number of cisterns is estimated to range from 2000 to 3000 (Shafie 1952; Paver and Pretorius 1954; Murray 1955; Kassas 1972). A cistern is described as a large underground chamber excavated in the ridge and plateau rock (Fig. 4). Excavated in Roman times (Ball 1935), the cisterns served as covered water reservoirs with capacities ranging from 200 to 500 m<sup>3</sup>, and some 2 000 m<sup>3</sup>.

The chamber interiors were plastered to prevent leakage. The material used by the ancients were either lime or homra (terra rosa or red soil) or even ash (Shafie 1952). Today, plastering is composed of a 1 to three ratio of sand-cement mortar which has proved to be durable. Canals transport the water to the mouth or orifice of the cisterns. The mouth of the cistern is underlaid with a mostly circular well with an approximate diameter of 1.0 meter. The walls of the wells are recessed to facilitate entrance for cleaning the chambers from the accumulation of silt.

The cistern site is carefully chosen to collect runoff from a considerable area, such as the following: (1) sloped surfaces of the coastal ridges; (2) top portion of the northern edge of the plateau (Fig. 5); (3) escarpment face (between +35 and +100 m) at the northern edge of the plateau where a variety of slopes (vertical, concave, waxing, dip) are found (Fig. 2); and (4) piedmont plain (+35 m) separating the escarpment face from the coastal plain (Figs. 6, 7).



Figure 4. A cistern in the ridge



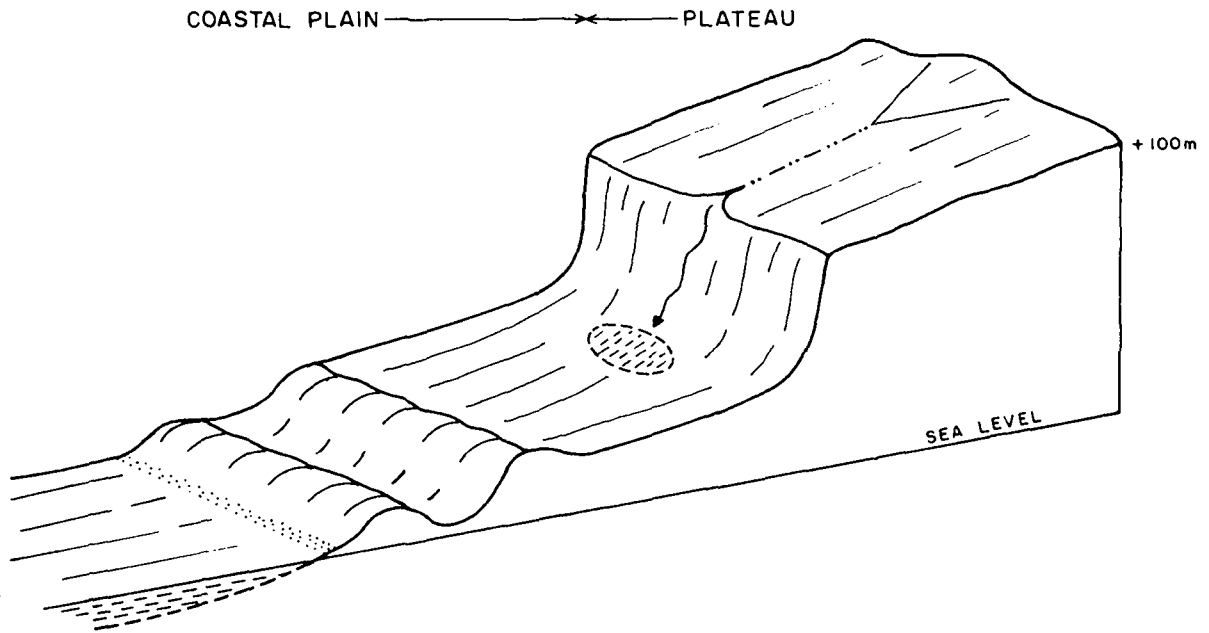

Figure 5. An odd cistern at Mersa Matruh

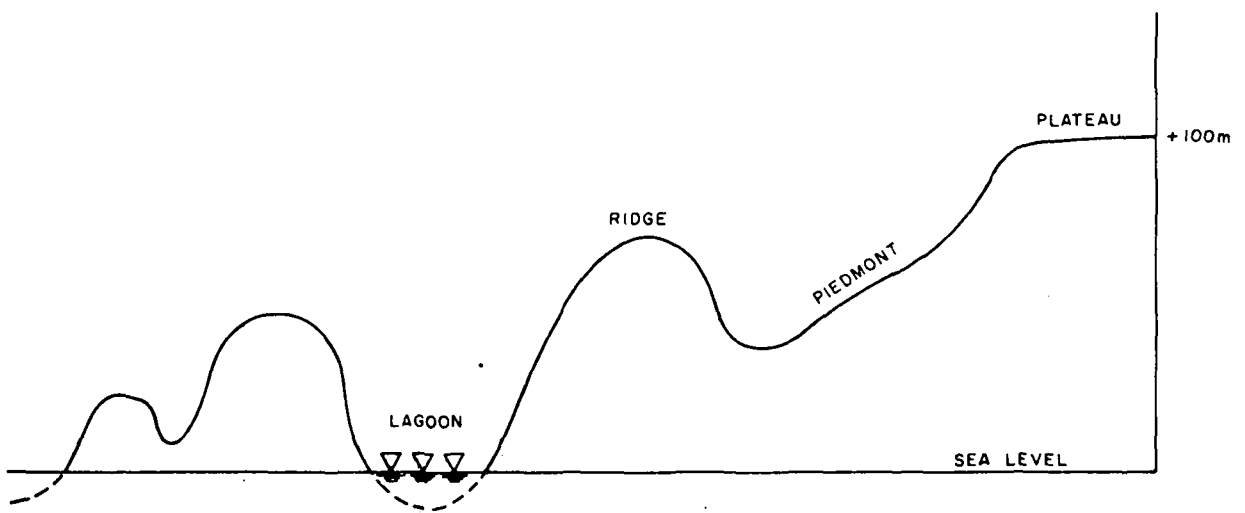

Figure 6. Different habitats of cisterns and karms

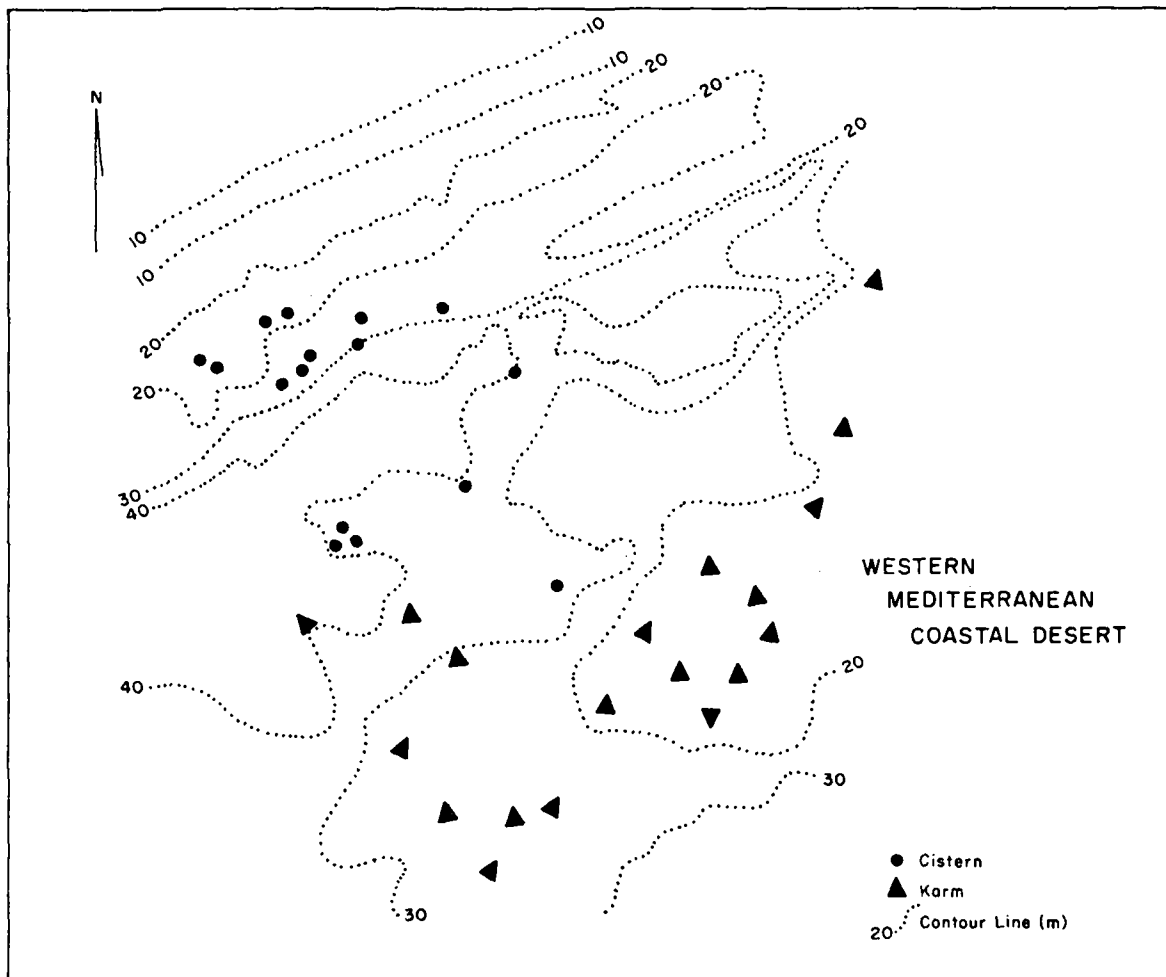

Figure 7. Distribution of cisterns and Karms

When the General Desert Development Organization was established in Egypt in 1959, the following program was presented in connection with the development of cisterns:

- Explore the location of ancient cisterns
- Clear accumulated sediments forming a cone from the discovered cisterns
- Repair and plaster the canals and banks or arms (pitched with stone set in cement and water) which transport water to the canals
- Provide silt traps in front of the cistern orifice and remove cattle troughs from the area to prevent contamination; and provide metal doors and locks on the wells leading to the cistern
- Construct new cisterns in locations similar to old cisterns.

In Egypt, cisterns belong to the government. Thus, although they cannot be monopolized by any individual, they can be used without cost by everyone.

## KARMS

Karm is the Arabic word for vineyard. A Karm is comprised of a series of artificial hillocks arranged in different forms (rectangular, circular, horse-shoe). According to Shafie (1952), these are open reservoirs or tanks formed by raised earth banks; but according to Murray (1955), Hellestrom (1955) and Kassas (1972), Karms are described as "artificial means of collecting rain water and concentrating it into limited areas where plants are grown." The runoff flows inside and outside the Karms on the slopes of the hummocks. Rectangular types of Karms are most dominant and the banks rise usually 3 to 4 m above the ground surface. The sides may not extend completely around the enclosed space (Kassas 1972).

In a detailed study of one Karm located close to Alexandria, Shafie (1952) noted the following:

1. The original Karm capacity was on the order of 25 000 m<sup>3</sup>; the present capacity hardly exceeds 10 000 m<sup>3</sup>
2. Banks were breached in two places as a result of gully erosion and/or holes of desert rats (*gerboa*)
3. No masonry outlets were found associated with the ancient construction
4. Water did not remain for a long period in the Karm; it disappeared in 20 to 30 days as a result of seepage and evaporation
5. Soils inside the Karm are conspicuously saline; today, Bedouins remove the saline crust before the winter rainy season.

In his discussion of the geographical distribution of Karms in the Mareotis District, Hughes (1921) found that "the vast majority do not begin till about the 5-meter contour above sea level and are seldom found above the 40-meter contour." According to De Cosson (1935) and as cited by Kassas (1972), Karms are found 30 km inland and mark the limit of cultivation in Graeco-Roman times.

## CONCLUSION

The Mareotis District receives an annual rainfall reaching one billion cubic meters. The major portion of this amount is, at present, lost through direct flow into the sea and into unfavorable areas in the foreshore lagoons. At least 250 million cubic meters of rain water can be conserved in that district through the improvement of ancient cisterns and Karms, as well as the construction of new ones. Both systems are the cheapest means for water conservation in that coastal desert area.

## REFERENCES

- Ball, J. 1935. The water supply of Mersa Matruh. Paper 43, Egypt Survey Department. 41 p.
- Ball, J. 1942. Egypt in the classical geographer, Cairo, Egypt: Government Press.

- De Cosson, A. 1935. *Mareotis*. London: Country Life.
- Hellstrom, B. 1955. *Water problems in arid zones*. Bull. No. 40, Institute of Hydraulics, Roy Institute of Technology, Stockholm, Sweden.
- Hume, W.F., and Hughes, F. 1921. The soils and water supply of the Maryut District west of Alexandria. Paper 37, Egypt Survey Department, 52 p.
- Murray, G.W. 1955. Water from the desert: Some ancient Egyptian achievements. *Geographic J.* pp. 121-171.
- Paver, G.L., and Pretorius, D.A. 1954. Report on reconnaissance hydrogeological investigations in the Western Desert coastal zone. Publi. Inst. Desert d'Egypt 5:145.
- Shafei, A. 1952. Lake Mareotis, its past history and its future development. Bull. No. 2, Inst. Desert d'Egypt, 71 p.
- Shata et al. 1962. Age and origin of groundwater in some desert areas of Egypt. Bull. No. 2, Inst. Desert d'Egypt.
- Shata, A. 1970. Geomorphology, pedology and groundwater geology of the Mediterranean Coastal Desert of Egypt. In *Symposium of the Geology of Libya*.

## RAIN WATER CISTERN SYSTEMS FOR THE HIMALAYAN REGION

Raj Kumar Gupta, Scientist

and

Vidya Sagar Katiyar, Scientist  
Central Soil and Water Conservation  
Research and Training Institute  
Dehradun (UP), INDIA

### INTRODUCTION

The Himalaya receives very heavy to heavy rainfall during the monsoon months of July to September. The annual rainfall varies from 900 to more than 2 000 mm in the western Himalaya, and even more in the eastern Himalaya of Assam, the location of Chirapunji which means "always raining". During the monsoon months, the region receives more than 80% of the total rainfall.

Most of the rainfall is lost as runoff into streams and rivers and causes problems of flooding in the lower reaches of the rivers. Acute scarcity of potable water is experienced in the region. Rural women are the worst sufferers because they have to walk long distances to fetch drinking water from far-off streams and springs. Due to heavy deforestation in the catchment areas, perennial springs supplying potable water have dried. Rainwater cistern systems could easily meet drinking water requirements in many areas, while in others, water could be harvested for livestock and life-saving protective irrigation.

### WATER RESOURCES AND CISTERN-SYSTEM DESIGN

The water consumption demand for domestic use has been standardized as per IS\* 1172 (1975), which comes to nearly 135 l/person. Availability of water from rainfall from the northwest Himalayan region is given in Table 1. Harvesting of water from roof catchment is an age-old practice. A case study conducted in the 370-ha Bhaintan watershed in the Tehri District of Gashwal, Himalaya, showed that 90% of the runoff amounting to 1 710 mm, of a total 1 900 mm, would be available from catchment. With an allowance of 20% reduction as evaporation, the net harvested rainfall available for water supply would be 1 368 mm. As an example, if the average roof surface is 6 x 5 m, the average water harvested would be  $30 \times 1.368 \text{ m}^3$  or  $41.04 \text{ m}^3$ , out of which 80%, i.e.,  $32.83 \text{ m}^3$ , would be available during the monsoon season. If an allowance of 10% utilization is maintained during the monsoon, water that could be stored would be about  $30 \text{ m}^3$ , on the basis of a storage tank size of 5 x 4 x 1.5 m.

Another method for designing a rainwater cistern is by using the water balance method, i.e., the input outflow method. The weekly probability of rainfall at 80% could be calculated and the outflow, i.e., evaporation and consumption, deducted from expected runoff. The tank size is determined on the maximum accumulated net water to be stored during the year.

\*Indian standard.

TABLE 1. MONTHLY RAINFALL OF SOME STATIONS IN THE NORTHWEST HIMALAYAN REGION

STATION NAME	RAINFALL												Total
	Jan.	Feb.	Mar.	Apr.	May	June	July (mm)	Aug.	Sept.	Oct.	Nov.	Dec.	
Nanital*	36.6	40.3	16.9	10.4	27.3	190.0	485.6	468.3	242.4	31.5	3.0	13.6	1565.9
Kilpuri	29.7	34.8	16.3	8.6	27.7	167.4	430.2	416.8	232.9	37.1	6.3	11.4	1419.2
Almora	42.9	49.3	42.2	27.9	48.3	143.8	264.9	234.9	130.3	32.3	7.4	21.3	1045.5
Pithoragarh	44.2	56.4	40.4	28.2	72.6	182.9	299.7	287.3	149.3	33.3	6.9	21.4	1222.6
Ranikhet	54.1	62.0	46.2	31.0	50.0	144.0	331.5	344.4	165.9	33.5	7.4	22.9	1292.9
Pauri Garhwal	60.7	66.8	55.1	32.0	51.6	132.3	326.1	359.9	148.3	33.8	8.1	28.2	1302.9
Srinagar†	55.1	56.1	36.8	22.1	42.7	118.4	244.1	223.3	97.3	24.9	5.6	21.8	948.2
Joshimath	65.8	92.7	98.5	54.4	35.1	88.9	176.3	184.7	108.5	28.2	12.2	27.4	972.7
Lansdown	16.8	73.1	45.0	28.5	53.1	201.9	626.4	627.9	316.0	44.5	6.1	27.2	2066.5
Simla	61.2	69.9	62.7	45.5	60.5	149.1	418.3	416.1	177.0	30.0	9.9	27.9	1528.1
Dharamshala	113.0	111.3	100.6	59.2	54.6	195.3	877.3	1000.0	324.1	37.6	14.0	57.1	2944.1

\*Includes 12 district stations.

†Garhwal.

Evaporation should be calculated from the total surface area of the storage system (storage tank). The size of the storage system can be calculated by a trial-and-error method as

$$W_{sm} = A_1/1000 CR_1 - E_r E_w - W_c/1000$$

and the depth of storage system determined as

$$D_s = W_{sm}/A_2$$

where

$W_{sm}$  = Maximum harvested water available for storage for future use in the year, in  $m^3$

$C$  = Runoff rainfall ratio

$R_1$  = Weekly precipitation, in mm

$E_r$  = Ratio of stored water surface area to catchment area

$E_w$  = Average daily evaporation, in mm

$W_c$  = Average weekly consumption by human and livestock, in  $\ell$

$A_1$  = Area of catchment, in  $m^2$

$A_2$  = Area of storage tank, in  $m^2$

$D_s$  = Depth of water to be stored (i.e., depth of water storage tank), in m.

The water requirement for human and livestock population can be calculated from Table 2.

TABLE 2. ANNUAL WATER STORAGE REQUIREMENTS FOR HUMAN AND LIVESTOCK POPULATION

FAMILY SIZE	NO. OF LIVESTOCK	WATER REQUIREMENT ( $m^3$ )		
		Domestic Use	Milch Cattle, Bullocks	Sheep, Goats
1	1	21	14	3
2	2	42	30	5
3	3	61	42	9
4	4	82	55	11
5	5	100	70	14
6	7	118	100	21
7	10	135	137	27
8	15	152	205	42
10	20	193	274	55

Assuming an average family size of five with four (1 buffalo, 3 sheep/goats) milch animals, the annual water requirements would be  $100 + 14 + 9 = 123 m^3$ . Hence, the water requirements for three months would be around  $31 m^3$ ,

and a 30-m<sup>3</sup> catchment would meet this requirement.

Rain water cisterns of 5 x 4 x 1.5-m size are sufficient to harvest water from roof areas of 30 m<sup>2</sup> using gutters of 'V' or 'U'-shaped channels of galvanized iron or polythene sheets. The storage system may be constructed with cement concrete or M.S. sheets. Since rain water is free from chemicals or other impurities, it may contain little sand particles, leaves or foreign material, which can be separated by simple screening. It would be desirable to construct this cistern 1 to 2 m above ground level to avoid lifting of water by pressure.

#### ACKNOWLEDGMENTS

Thanks are due to Mr. G.P. Juyal, Scientist, S-1 (Engrg.) and Mr. C.P. Mathur, Scientist 'S' of the Central Soil and Water Conservation Research and Training Institute, Dehradun (UP) for the help provided.



## CARTHAGINIAN-ROMAN CISTERNS IN SARDINIA

Francesca M. Crasta, Researcher  
 Institute of Philosophy  
 University of Cagliari  
 09100 Cagliari, ITALY

Costantino A. Fassò, Professor  
 Institute of Hydraulics  
 University of Cagliari  
 09100 Cagliari, ITALY

Francesco Patta, Professor  
 Institute of Hydraulics  
 University of Cagliari  
 09100 Cagliari, ITALY

Giorgio Putzu, Researcher  
 Institute of Hydraulics  
 University of Cagliari  
 09100 Cagliari, ITALY

### HISTORICAL INTRODUCTION

The island of Sardinia remained a Phoenician-Carthaginian colony for about a millenium. The Phoenicians first began to settle on the island during the 9th to 7th century B.C., founding several ports of call to carry out trade by sea. Of these ports, Cagliari, Nora, Bithia and Tharros are evidence of the role that the island's southern coast played in supporting the commercial routes of the Mediterranean (Fig. 1).

From the 6th century B.C. onwards, the Phoenician colony of Carthage, which had become one of the most important cities of the Mediterranean basin, assumed hegemony of the sea traffic, and the Phoenician centers in Sardinia passed under its domination. Carthaginian expansion in the island reached its peak between the 4th and 3d century B.C.: the existing ports of call became real urban centers and, in addition, new inland settlements emerged for the development of agriculture and the exploitation of mines.

With the first of the three wars between Rome and Carthage, Carthaginian supremacy in the Mediterranean and in Sardinia was immediately compromised. In fact, in 238 B.C., three years after the end of this war, the Romans occupied the island and from 227 B.C. it became, together with Corsica, a Roman province.

However, the political annexation of the island to Rome did not shatter Carthaginian resistance, fomented and supported by the Sardinians, who had gradually integrated themselves with the Carthaginians, thus giving rise to a civilization usually referred to by historians as Sardo-Carthaginian. The main reason why this civilization remained and the cause of its vitality is to be sought not only in the widespread Carthaginian penetration and in the ethnic integration between Sardinians and Carthaginians, but also in the well-being that the island had enjoyed during the period of Phoenician-Carthaginian commercial and political supremacy. This civilization, which enjoyed the height of its splendour in the 3d century B.C., continued to resist Roman occupation. It was only in the 2d to 3d century A.D., i.e., long after the destruction of Carthage (146 B.C.) and when the process of Romanization of the island had been decisively concluded that the Sardo-Carthaginian civilization began to decline.

The prolongation of the Phoenician-Carthaginian presence on the island is clearly witnessed by archaeological and epigraphical findings. For instance,

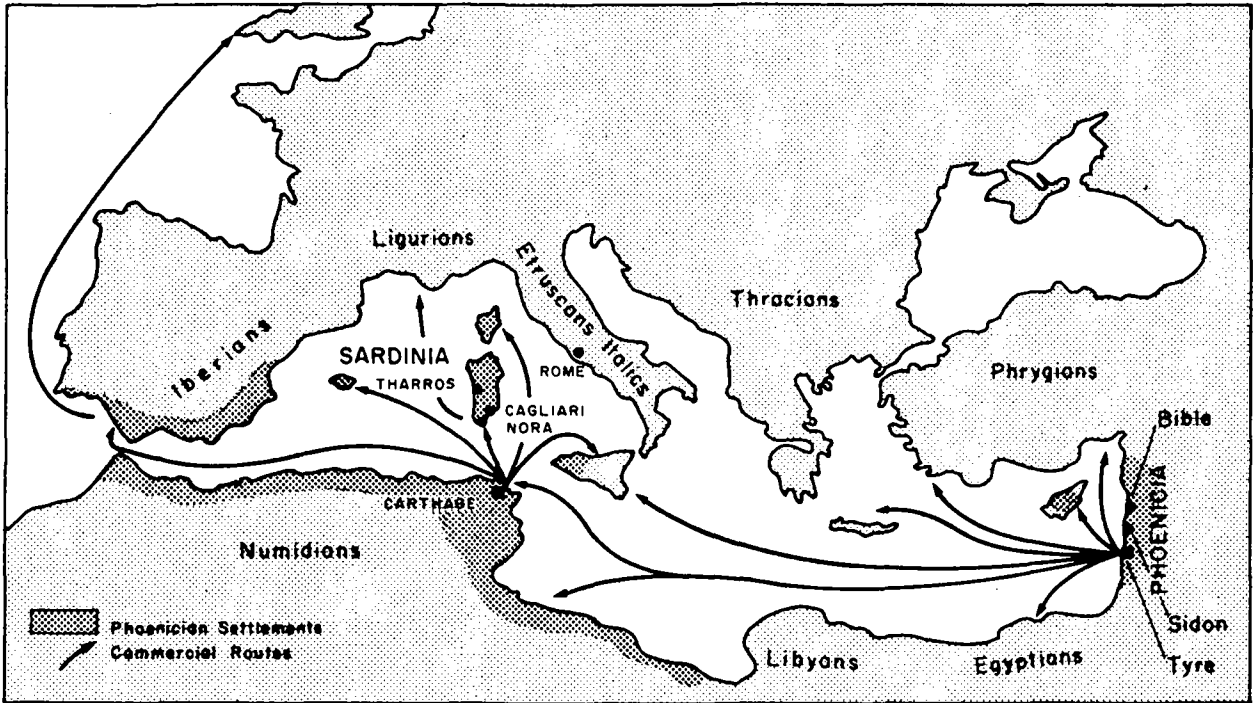

Figure 1. Phoenician colonization

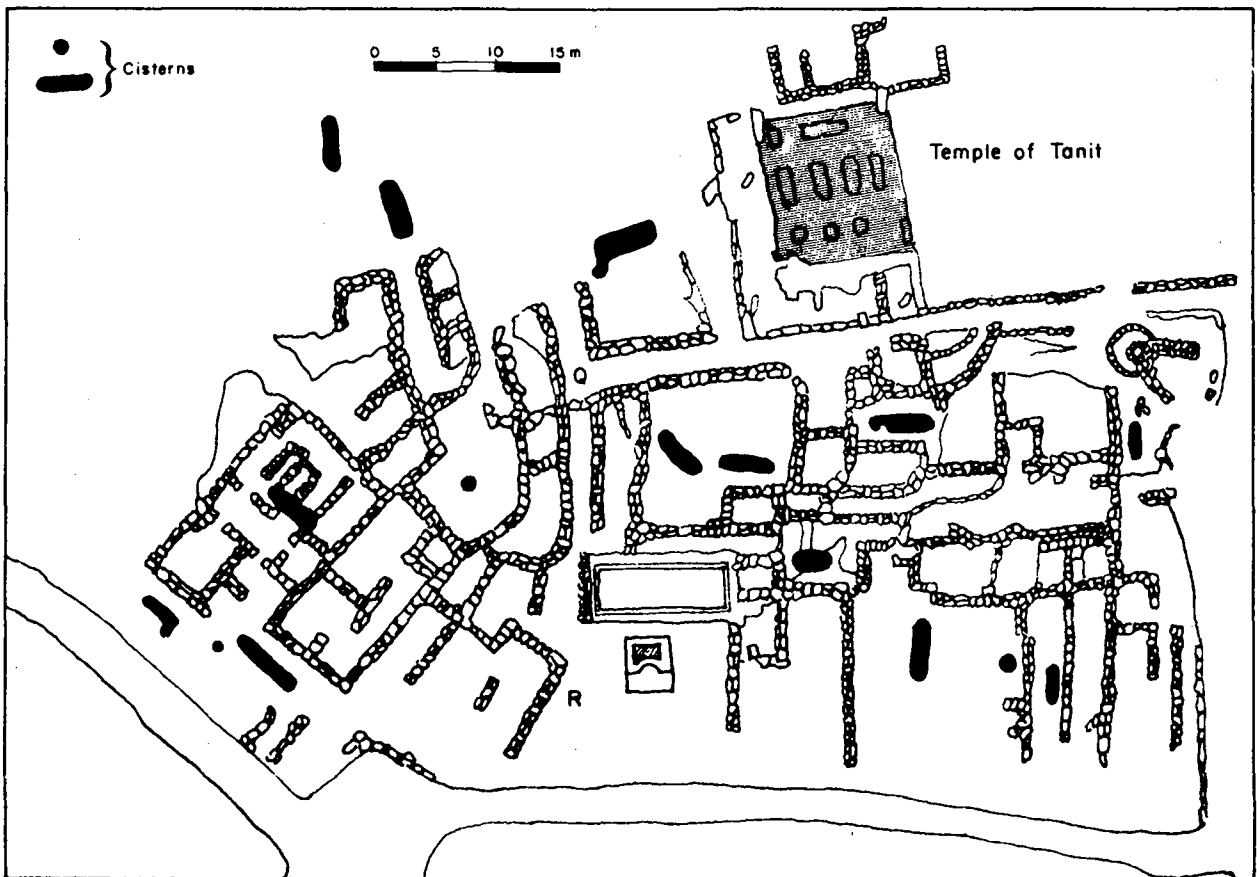

Figure 2. Carthaginian residential quarter of Nora

excavations at Nora, Tharros and Cagliari evidenced not only the superposition of Roman on Phoenician-Carthaginian structures, but also examples of the persistence of Carthaginian building traditions in housing even in the late Roman Age.

During the Phoenician-Carthaginian period and the early centuries of Roman domination, rain water cisterns represented the principal source of water supply for the urban centers situated along the coast. These cisterns (which of the artifacts unearthed by archaeological excavations are those in a better state of preservation) were necessary because the hydrogeological conditions of the Sardinian coasts limited the possibilities of water supply from wells and springs. Moreover, the climate, which is characterized by the 5- to 6-month concentration of rainfall, necessitated the storage of rain water in cisterns of considerable size.

It was not until the advent of the Romans, masters in the construction of aqueducts, that the conveyance of spring water even over great distances became feasible. It was during this period that aqueducts were built to serve Nora, Tharros and Cagliari. The Cagliari aqueduct (some 50 km long) was built around 140 A.D. and fell into disuse—as the majority of those built by the Romans—with the fall of the empire. Consequently, the rain water cisterns continued to be used right up until the end of the 19th century.

During the Middle Ages, unlike Cagliari, the cities of Nora and Tharros were abandoned because of the threat of pirate raids.

In the following sections, the authors examine the cisterns installed at Nora, Tharros and Cagliari before the construction of aqueducts.

#### TYPES OF CISTERNS

The types of rain water cisterns most commonly used in the period considered here are the "bath-tub" and "flask" cisterns. Some examples of large cisterns, which will be referred to as "cave" cisterns, have also been discovered in Cagliari.

"BATH-TUB" CISTERNS. This type of cistern is an elongate, parallel pipe, with a semicylinder at each end (Fig. 3a). In rare cases, one or both of these semicylinders are missing. The cistern cover or roof most commonly adopted is of the "cowl" type (Fig. 3e), i.e., consisting of two inclined slabs of stone or terra-cotta braced against each other at the apex. In Figure 5a, the abutment of the slab, which bears the thrust, can be observed. Less frequently, the roof consisted simply of horizontal stone slabs.

The roofs of dwellings served as catchment areas for rain water which was conveyed via terra-cotta drainpipes (incorporated in the walls) into the cisterns. At the bottom end of this drainpipe, an elbow connected a quasi-horizontal pipe section which terminated in the cistern. From the latter, a narrow spillway canal discharged into a gutter, or sometimes into another cistern at a lower level. These canals, as well as the quasi-horizontal sections of the feed pipes, could be rectangular canals of masonry or of hewn rock, and covered with terra-cotta or stone slabs; semicircular, terra-cotta canals covered by flat slabs (Fig. 5c); or underground terra-cotta piping (Fig. 5b).

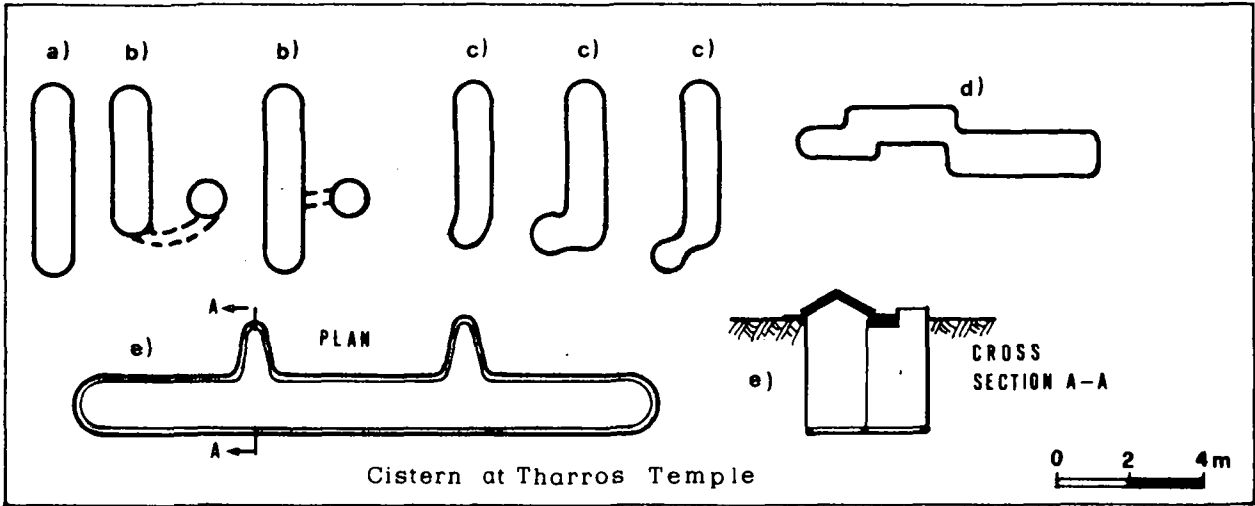

Figure 3. "Bath-tub" cisterns

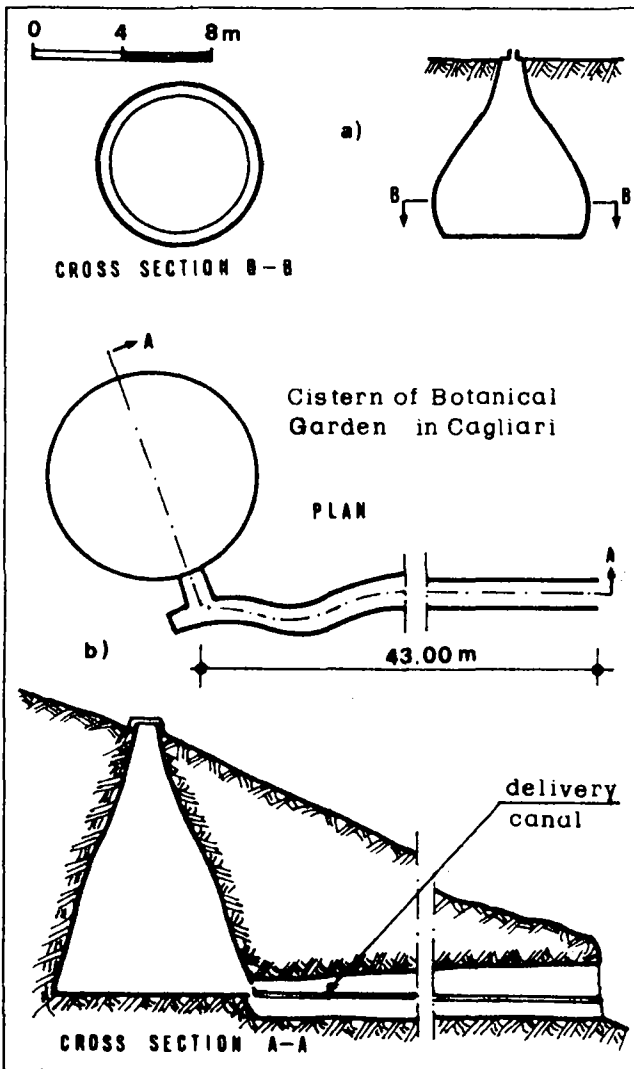

Figure 4. "Flask" cisterns

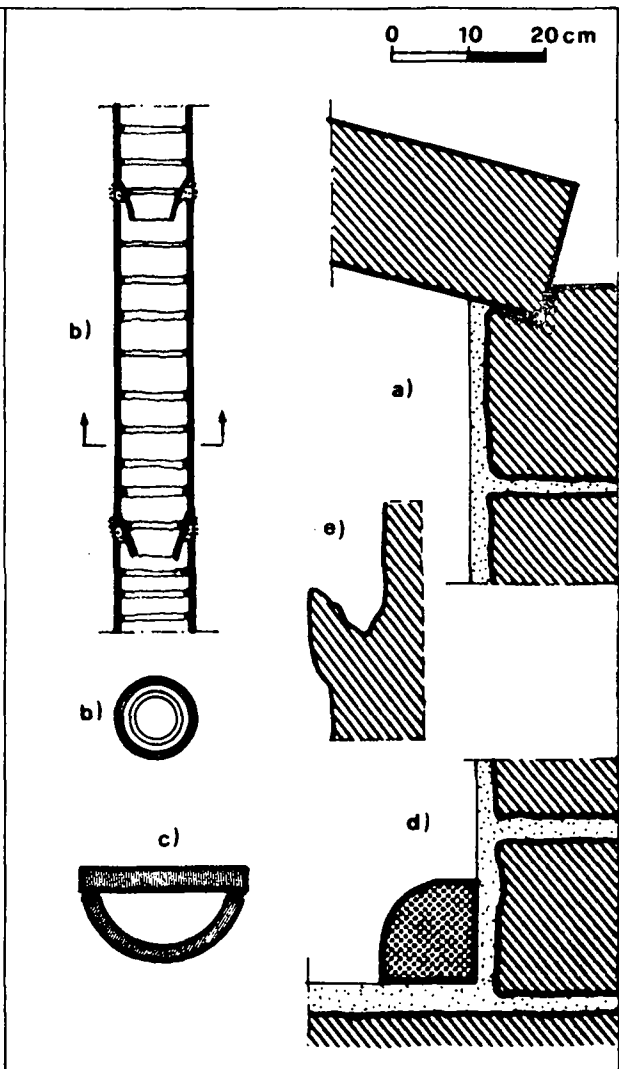

Figure 5. Technical details

The water was drawn from a hole bored in the roof near one of the cylindrical ends of the cistern, or from a small well dug to one side of the cistern, of the same depth and connected by a small tunnel (Fig. 3b). Sometimes the well was no more than an extension of the cistern whose configuration then was "pistol-shaped" (Fig. 3c). In general, a circular, usually monolithic, rim of 40 to 50 cm in diameter was built around the mouth of the well; rectangular rims were rarely built. Some cisterns were furnished with two or three openings and, in a few, were partitioned with an internal wall. In some cases, the configuration of the bath-tub cistern was similar to building foundation (Fig. 3d). Moreover, L-shaped cistern of equal or unequal length have also been found.

The width of the bath-tub cisterns was almost identical—about 1 m\*, while the depth varied from 2 to 4 m and the length from 3 to 8 m. Only in a few cases were these dimensions exceeded. For example, the maximum width has been 2 m, and the length of the cistern found in the Temple of Tharros (Fig. 3e) is 15 m.

"FLASK" CISTERNS. These cisterns are shaped like a complete flask (Fig. 4a) or sometimes like the upper part of a flask, with the lower tapered part missing (Fig. 4b). No fixed ratio exists between the height and the maximum diameter. The capacity of this type of cistern varies much more than the bath-tub type and ranges from a few cubic meters to the 250 m<sup>3</sup> of the Roman cistern in the Botanical Garden of Cagliari (Fig. 4b). Rainfall runoff was collected by a network of small canals dug into the ground and stored in the large cisterns.

In the small cisterns, water was drawn from the top, i.e., from the neck of the flask, which in general was surrounded by a plastered parapet. In the large cisterns, water was drawn from the bottom, to which access was gained through a tunnel. In the large cistern of the Botanical Garden in Cagliari (Fig. 4b), the water flowed out along a small, 8 cm deep, triangular canal, excavated half way along the wall of the access tunnel, with an average slope of about 7% (Fig. 5e). Today, by walking along the tunnel, one can enter the cistern through an opening, which in normal operation, was probably blocked by a wall. As in the majority of Roman hydraulic works, no trace was found of the tap which must have undoubtedly existed.

"CAVE" CISTERNS. In Cagliari, remnants exist of a large cistern of this type that was hewn from rock and then plastered. The cave cistern was approximately shaped like a parallel pipe, 50 × 50 m, 5 to 6 m deep and, therefore, with a capacity in excess of 10,000 m<sup>3</sup>. The overhead rock was supported by pillars of bedrock.

#### TECHNICAL DETAILS

The majority of the bath-tub cistern discovered at Nora and Tharros are hewn from the bedrock. However, numerous examples have also been found of cisterns dug into loose soil. In the latter instance or in the case of poor

\*Corresponds to about 2 Carthaginian or Roman cubits, of which the former is equal to 52 cm, the latter to 54 cm.

quality rock, the cistern walls were lined with ashlar arranged in horizontal layers. At Nora, sandstone ashlar 30 to 40 cm high are still visible and, in the inner cistern wall, small horizontal and vertical grooves have been cut about 10 cm apart, obviously to facilitate the adherence of the plaster.

In fact, with few exceptions, such as cases where the rock was compact and therefore watertight, the cisterns were skillfully plastered. The plaster consisted of a hydraulic mortar of lime and inert material (limestone, quartz and small terra-cotta fragments). Several coats of mortar were applied to ensure watertightness. In Carthaginian times, ash was added to the final coat of mortar. This increased the very fine friction, thus improving the workability of the mortar, and resulting in easier application and a smoother finish. In this way, the plaster was rendered watertight and resistant. As a matter of fact, in some of these ancient cisterns, the plaster is still in excellent condition.

As mentioned previously, because the ends of the cistern had a concave semicylinder shape and therefore no sharp corners, the risk of fracturing was minimized. For similar reasons, the angle between the wall and floor of the cistern was plugged with a convex curb (Fig. 5d).

The drainpipes connected to house roofs were usually constructed of terra-cotta and were about 50 cm long. One end of the pipe was tapered to fit into the cylindrical end of the next, achieving in this way a sort of bell-and-spigot joint, different from those currently in use in that the male was tapered rather than the female enlarged (Fig. 5b). These joints were sealed with lime mortar. The external surface of the pipe is cylindrical with about a 100-mm diameter (at Nora a pipe has been found with a 150-mm diameter); however, the internal surface is not smooth but presents an annular relief that results in wall thicknesses that vary from 6 to 10 mm.

Both the type of joint and the corrugated inside wall of the pipe demonstrate that no attention was paid to flow resistance. In Roman times, lead pipes were also employed, in addition to terra-cotta piping. In the large cistern in the Temple of Tharros, a lead pipe was found on the bottom which could have served as a drain or, presumably, as an intake.

The flask cisterns were hewn from bedrock. A thick coating of hydraulic mortar covered any cracks in the rock and surface imperfections. Many of the flask cisterns discovered in Cagliari still have plaster in perfect condition.

#### LOCATION AND UTILIZATION

The bath-tub cisterns are typical of the Phoenician-Carthaginian civilization. Archaeological excavations at Nora and Tharros have revealed cisterns constructed within the urban structure. However, in Cagliari, where the Phoenician-Carthaginian urban structure has been entirely distorted by later superpositions, no appreciable evidence remains of the bath-tub cisterns. The majority of the cisterns were small and for household use; others have been discovered near ports for supplying ships with water, and near temples for ritual uses. Figure 2 is an example of the layout of one of the Carthaginian residential quarters at Nora. The houses are joined to each other and are accessible—apart from the roads surrounding the quarter—only from the cen-

tral pathway, Q-R. The cisterns for household use are generally situated under the atrium or central courtyard. The opening for drawing water is usually located inside the house, rarely in the courtyard. Cisterns with two or three openings served several households. The foundations of the building sometimes formed part of the cistern wall and this explains the configuration seen in Figure 3d.

In Sardinia, bath-tub cisterns were still being built during the Roman period (see the large cistern adjacent to the Temple of Tharros in Fig. 3e). This is explained by the perfection attained in Carthaginian building techniques and by the employment of local labor, trained according to Carthaginian traditions. This is one particular example of the persistence of Carthaginian culture in the island, referred to in the Introduction.

The flask cisterns, rarely employed in Carthaginian times, were developed on a large scale by the Romans. Numerous examples of this type of cistern, some of which are of considerable capacity, have been discovered in Cagliari, but only a few examples of small cisterns remain at Nora and Tharros.

Up until the introduction of aqueducts, the Romans solved the problem of storing large quantities of water required for public use (baths, latrines, fountains, laundries, gardens), by employing flask and cave cisterns. The demand for water was particularly high in the city of Cagliari, which expanded considerably under Roman Domination. In fact, in addition to the remains of small cisterns for household use, examples of large flask and cave cisterns, which were evidently for public use or for supplying entire districts, have also been discovered in Cagliari.

To more efficiently distribute water, collection and distribution chambers were built. There were fed by the large cisterns hewn from the rocky hills of the city, through tunnels sometimes of considerable length. The water drawn from the bottom of the cisterns flowed through these tunnels in a similar manner to that described for the cistern in the Botanical Garden (Fig. 4b).

This system of rain water cisterns represents the most efficient stage achieved in the water supply of the city of Cagliari, prior to the construction of the Roman aqueduct.

From 140 A.D. onwards, the same water distribution system continued to be employed, using spring water carried to the city by means of the aqueduct.

#### CISTERN DESIGN AND PROBABLE PER CAPITA CONSUMPTION

The following considerations are based on the assumption that the climate during the period examined did not substantially differ from the present-day climate. In Cagliari, the average rainfall during the 50-year period (1921-1970) was 435 mm per year, and that of the driest year, 231 mm. Rainfall distributed over the months for this period are as follows:

Rainfall (mm)											To- tal	
J	F	M	A	M	J	J	A	S	O	N		D
47	45	40	33	31	9	3	7	31	61	61	67	435

The average distribution of the monthly rainfall is characterized by a 3-month period in the summer with very little rainfall; in dry years, there is practically no rain for four consecutive months. One can therefore deduce that the cisterns had to be designed for a capacity of at least one-third of the annual consumption. To calculate the catchment area, a reduction coefficient value of 0.8 can be assumed for the roofs (often made of caulked wood in Carthaginian dwellings) and 0.4 for the soil (based on the type of rocky ground).

Assuming a minimum annual rainfall of 231 mm, a roof area of 5.4 m<sup>2</sup> and a ground area of 10.8 m<sup>2</sup> is required to catch 1 m<sup>3</sup> of rainfall. Similarly, with an average value of 435 mm per year, respective roof and ground areas of 2.9 and 5.8 m<sup>2</sup> would be sufficient.

For example, let us consider the previously described residential quarter of Nora (Fig. 2), which covers an area of some 3 200 m<sup>2</sup>. By subtracting 25% for courtyards and access, one obtains a roof area equal to 2 400 m<sup>2</sup>. The overall capacity of the cisterns in this residential quarter is about 150 m<sup>3</sup> which, according to the hypothesis previously advanced on dimensions, corresponds to an annual availability of 450 m<sup>3</sup>. This quantity can be said to correspond to the amount of water which can be collected in the driest year from the entire roof area which, therefore, had to be utilized to catch rain water.

Assuming that the minimum per capita consumption was 2 liters per day, one can deduce that no more than 615 people lived in the district, which corresponds to a density of 1920 inhabitants per hectare, or 5.20 m<sup>2</sup> per inhabitant—a high density attributed by several researchers to the probable existence of more than one-story dwellings. On the other hand, assuming a density of only 1000 inhabitants per hectare, i.e., 10 m<sup>2</sup> per inhabitant, 320 inhabitants would have resided in the district and the average daily consumption would have risen to 3.85 liters. Similar results were obtained for the same type of residential quarter at Tharros.

It is extremely difficult to advance a hypothesis on the per capita consumption for Cagliari. However, if one accepts the estimate of 20,000 inhabitants during the Roman period postulated by some authors, the capacity of the large cisterns known to exist can be established, with precaution, on the order of 12 000 m<sup>3</sup>. Assuming once again a cistern capacity of about one-third of the annual volume available and a minimum rainfall of 231 mm, the catchment area is about 39 hectares and the average daily consumption approximately 5.3 liters per inhabitant per day. Thus, one can assume this value as the minimum daily consumption.

#### ACKNOWLEDGMENTS

The authors wish to express their appreciation to Professor Ferruccio Barreca and Dr. Piero Bartoloni for their helpful discussions, and to Messrs. Pietro Atzori and Giancarlo Chiappe, who carried out the surveys.

#### REFERENCES

- Barreca, F. 1961. La città punica in Sardegna. *Bollettino del Centro di Studi per la Storia dell'Architettura*, vol. XVII, pp. 24-47.



- Barreca, F. 1979. *La Sardegna fenicia e punica*. Sassari: Chiarella.
- Lilliu, G. 1947. Notiziario archaeologico (1940-1947). *Studi Sardi*, Vol. VII, pp. 252-254.
- Lilliu, G. 1950. Scoperte e scavi di antichità fattisi in Sardegna durante gli anni 1948-1949. *Studi Sardi*, vol IX, p. 498.
- Moscatti, S. 1978. *Fenici e Cartaginesi in Sardegna*. Milano: Mondadori.
- Pesce, G. 1966. *Tharros*. Cagliari: Fossataro.
- Pesce, G. 1972. *Nora guida agli scavi*. Cagliari: Fossataro.
- Piredda, M.E. 1974. L'approvvigionamento idrico di Cagliari in età punica e Romana. *Studi Sardi*, vol. XXIII, pp. 149-180.

## STOCHASTIC DYNAMIC MODELS FOR RAINFALL PROCESSES

Samir A. Ahmed, Assistant Professor  
School of Civil Engineering  
Oklahoma State University  
Stillwater, Oklahoma 74078, USA

and

Yu-Si Fok, Professor  
Department of Civil Engineering  
Researcher  
Water Resources Research Center  
University of Hawaii at Manoa  
Honolulu, Hawaii 96822, USA

## INTRODUCTION

In recent years, there has been a revival of interest in using rain water cistern systems (RWCS) as a supplement to rural and urban residential water supply (Fok et al. 1980; Fok, Murabayashi, and Fong 1979). The reasons for this have been the increasing demand for water and the lack of adequate supply. Curtailment of new urban developments and limits on new house-building permits because of water shortages have been reported in many areas, such as Orange County, California and all the counties of Hawaii. In addition, it may not be feasible in some areas—the Hawaii Volcanoes National Park, for example—to install pipelines for water supply (Wentworth 1959). Fok, Murabayashi, and Fong (1979) find that for residential houses located in areas with an annual rainfall of about 508 mm (20 in.), RWCS's may be reasonable and cost effective as their main or supplemental source of water supply.

To properly design and operate a RWCS, it is necessary to understand the dynamic and stochastic nature of rainfall processes. These processes evolve continuously in time, thus suggesting models of differential equation form to describe their characteristics. However, since rainfall data are often collected at a series of discrete points in time, differential equation models can be directly used to fit such data. The parameters of the estimated discrete model can then be used to construct continuous time models if the data have been obtained through uniform sampling of the continuous process. The details of such a procedure for modeling, predicting, and simulating rainfall processes are explored in this paper.

## BACKGROUND

Since the publication of the well-known text by Box and Jenkins (1970), there has been a widespread use of stochastic modeling techniques in many fields of applied science, including water resources, economics, and transportation. In fact, most of the applications relating to water resources have been in the area of operational hydrology. Hipel and McLeod (1978 $a,b$ ) fitted nonseasonal Box-Jenkins models and fractional Gaussian noise models to annual hydrological time series data. They also suggested deseasonalized and auto-

regressive models for monthly and weekly hydrological observations (Hipel and McLeod 1979a; McLeod and Hipel 1978b). Fok et al. (1980) applied the Bayes-Markov analysis to simulate the weekly rainfall at Pauoa Flats, Hawaii. Several daily river flow models have been proposed, including the shot noise model (Weiss 1977), the daily river flow model of Treiber and Plate (1977), the nonlinear autoregressive model of O'Connell and Jones (1979), and the non-parametric Markov chain model of Yakowitz (1978).

Other stochastic models which are similar to the Box-Jenkins models have also been suggested for modeling the environmental impacts of natural and man-induced interventions. Hipel et al. (1975) applied the intervention analysis technique to study the effects of the Aswan dam on the average annual flows of the Nile River at Aswan, Egypt. The same technique was also used to model the effects of a forest fire on the seasonal flows of a river in Newfoundland (Hipel et al. 1977). An excellent discussion of the applications of stochastic modeling techniques to water resources systems can be found in Hipel and McLeod (1979b).

#### UNIFORMLY SAMPLED RAINFALL MEASUREMENTS

In analyzing the characteristics of rainfall, one is usually interested in the amount of rain water  $X(t)$  present at time  $t$ . The dynamic behavior of  $X(t)$  over a sampling interval can be regarded as a realization of a continuous time process that can be decomposed into a deterministic component  $F(t)$  and a stochastic noise component  $\varepsilon(t)$  according to the additive model,

$$X(t) = F(t) + \varepsilon(t) . \quad (1)$$

In general, the deterministic component  $F(t)$  can be represented by a constant level or polynomial trend. The noise component  $\varepsilon(t)$ , which is assumed to be stationary and time-homogeneous, is responsible for generating the stochastic character of  $X(t)$ .

Because rainfall measurements are usually collected at discrete points,  $\Delta t$  units apart in time, it would be more desirable to work directly with the discrete time series  $\{X_t\}$ , where

$$X_t = X(t, \Delta t); t = 1, 2, 3, \dots \quad (2)$$

Figure 1 shows a plot of the time series of the average weekly rainfall at Pauoa Flats, Oahu, Hawaii, with 52 observations spaced one week apart during 1973. The remainder of this paper is a discussion of the use of such data to build a model that describes the stochastic behavior of rainfall.

#### DISCRETE STOCHASTIC RAINFALL MODELS

In modeling the time series of many types of physical phenomena, it is often reasonable to assume that the time series is either stationary, i.e.,  $F(t)$  can be represented by a mean value  $\mu$  or can be reduced to a stationary form by introducing the difference operator  $\nabla^d$  which has the property  $\nabla^d X_t = X_t - X_{t-d}$ . Since the discretized noise components  $\varepsilon_t$  are serially correlated, the basic idea in modeling the stochastic behavior of  $\{X_t\}$  is to represent  $\varepsilon_t$

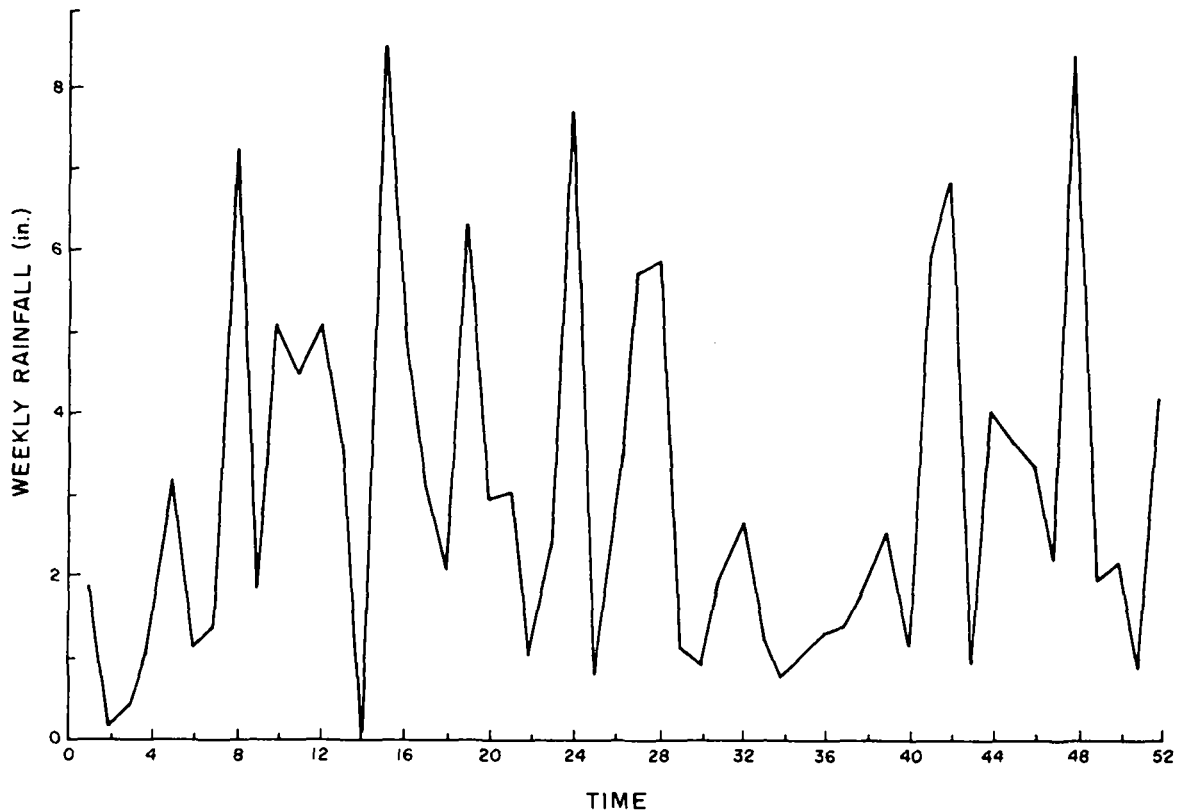

Figure 1. Weekly rainfall at Pauoa Flats, O'ahu, Hawaii

by a white noise sequence  $(a_t, a_{t-1}, a_{t-2}, \dots)$ , where the  $a$ 's are independent variables with mean zero and variance  $\sigma_a^2$ . Thus, the observation  $X_t$  can be expressed as

$$X_t = F_t + \Psi(B) a_t \quad (3)$$

where  $B = 1 - \nabla$  is the backwards operator, and  $\Psi(B)$  is the transfer function of the filter relating  $a$ 's to  $\varepsilon$ 's. It turns out, therefore, that the major task in modeling a given time series is the choice of the appropriate linear filter which generates a correlation sequence similar to that observed in the  $X_t$  series.

The time series of observations on many physical phenomena can be represented by the broad class of linear models as

$$\Phi_p(B)(X_t - \mu) = \Theta_q(B) a_t \quad (4)$$

where

$p, q =$  nonnegative integers

$\mu =$  mean of the  $X_t$  series

$\Phi_p(B) =$  autoregressive operator of order  $p$

$$= 1 - \theta_1 B - \dots - \theta_p B^p$$

$\theta_q(B)$  = moving average operator of order  $q$   
 $= 1 - \theta_1 B - \dots - \theta_q B^q$ , and

$a_t$  = white noise variables assumed to be independently distributed  
 as  $N(0, \sigma_a^2)$ .

The models in equation (4) have been formulated by Box and Jenkins (1970) and are usually referred to as autoregressive moving average (ARMA) models of order  $(p, q)$ . The transfer functions of the filters used by these models have the general form,

$$\Psi(B) = \Theta_q(B)/\Phi_p(B) . \quad (5)$$

As shown in Figure 2, ARMA models are fitted to an observed series by a three-stage iterative procedure: preliminary identification, estimation, and diagnostic checking. In preliminary identification, the values of  $p$  and  $q$  are determined by inspecting the autocorrelations and partial autocorrelations of the series, and comparing them with those of some basic stochastic processes. The sample autocorrelation function at lag  $k$  is given by

$$r_k = \frac{\sum_{t=1}^{n-k} (X_t - \bar{X})(X_{t+k} - \bar{X})}{\sum_{t=1}^n (X_t - \bar{X})^2}, \quad k = 1, 2, \dots \quad (6)$$

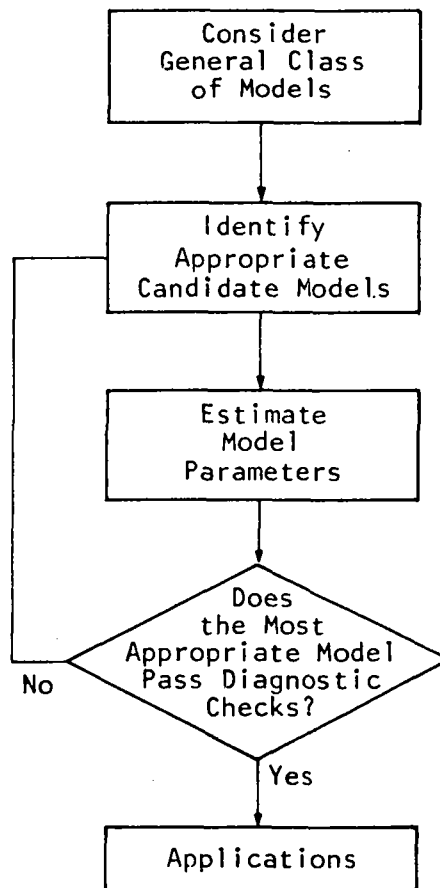

Figure 2. Iterative procedure for model development.

where  $\bar{X}$  is the sample mean and  $n$  is the number of observations. In general, the autocorrelation function of a moving average process of order  $q$  has a cut-off after lag  $q$  (memory of lag  $q$ ), while its partial autocorrelation function tails off. Conversely, the autocorrelation function of an autoregressive process of order  $p$  tails off in the form of damped exponentials and/or damped sine waves, while its partial autocorrelation function has a cutoff after lag  $p$ . For mixed processes, both the autocorrelation and partial autocorrelation functions tail off. Failure of the autocorrelation function to die out rapidly suggests that differencing is needed.

Once the values of  $p$  and  $q$  have been determined, the autoregressive and moving average parameters are estimated using nonlinear least squares techniques. Finally, the goodness of the fitted model is checked. If the form of the identified model is satisfactory, then the resulting residuals,  $a_t$  should be uncorrelated random deviations. To test for this, Box and Pierce (1970) developed an overall test of residual autocorrelations for lags one through  $k$ . They found that the variable

$$Q = n \sum_{i=1}^k r_i^2(\hat{a}) \quad (7)$$

where

$n$  = number of observations minus the degree of differencing

$r_i(\hat{a})$  = residual autocorrelation at lag  $i$ .

$Q$  is approximately distributed as a chi-square variable with  $(k-p-q)$  degrees of freedom.

#### CONTINUOUS STOCHASTIC RAINFALL MODELS

Following Phadke and Wu (1974), a general class of stochastic models that can be used to represent continuous stationary processes is that described by the differential equation,

$$\begin{aligned} D^p X(t) + C_{p-1} D^{p-1} X(t) + \dots + C_1 D X(t) + C_0 [X(t) - \mu] = \\ b_0 Z(t) + b_1 D Z(t) + \dots + b_q D^q Z(t) \end{aligned} \quad (8)$$

In equation (8),  $D$  is the differential operator defined as  $D^q = d^q/dt^q$ ,  $c_i$ , where  $i = 0, 1, \dots, p-1$  are the parameters of a continuous autoregressive process; and  $b_j$ ,  $j = 0, 1, \dots, q$  are the parameters of a continuous moving average process. Finally,  $Z(t)$  is a continuous white noise process with zero mean and the autocovariance function,

$$\gamma_Z(U) = \sigma^2 \delta(U) \quad (9)$$

where  $\delta$  is the Dirac delta function.

The models defined by equation (8) are the continuous analog of the Box-Jenkins discrete ARMA ( $p, q$ ) models. In particular, Phadke and Wu (1974) found that when a stationary continuous ARMA ( $p, q$ ) process is uniformly sampled, the resulting process is a discrete ARMA ( $p, p-1$ ). The parameters  $\phi_1, \phi_2, \dots$ ,

$\phi_p$  and  $\theta_1, \theta_2, \dots, \theta_{p-1}$  of the resulting ARMA (p, p-1) process depend on the sampling interval  $\Delta t$ . For the uniqueness of correspondence between the parameters of the continuous and discrete processes, the sampling rate must be at least twice the highest frequency corresponding to the complex roots of the differential operator (Phadke and Wu 1974).

To estimate the parameters of the continuous process, the autocovariance function of the fitted discrete model must be determined first, and then the continuous model parameters obtained so that they give rise to an equivalent autocovariance function. Phadke and Wu (1974) show that the autocovariance function of the continuous process can be expressed in the form

$$\gamma(U) = \sum_{i=1}^p A_i \exp(\alpha_i |U|) \quad (10)$$

where the  $A_i$ 's are constants depending on the parameters of the continuous process and  $\alpha_i$ 's are the roots of the characteristic equation,

$$D^p + C_{p-1}D^{p-1} + \dots + C_1D + C_0 = 0. \quad (11)$$

Furthermore, by letting  $G_i = \exp(\alpha_i \Delta t)$ , it follows that

$$1 - \sum_{i=1}^p \phi_i B^i = \sum_{i=1}^p (1 - G_i B) \quad (12)$$

where the  $G_i^{-1}$ 's are the roots of  $\Phi(B) = 0$ . For the discrete process, the theoretical autocovariance function  $\gamma_k$  at lags  $k = \Delta t, k = 2\Delta t$ , and so forth, is given by

$$\gamma_k = \sum_{i=1}^p A_i G_i^{|k|}. \quad (13)$$

Equations (12) and (13) are the general expressions that relate the parameters of the continuous process to those of the discrete process. As noted, the discrete autoregressive parameters depend only on the continuous autoregressive parameters, whereas the discrete moving average parameters depend on all the continuous parameters.

#### FORECASTING AND SIMULATION

If a discrete ARMA model passes the diagnostic checks, then it can be used to forecast future values of the fitted time series. Box and Jenkins (1970a) show that the minimum mean square error forecast of  $X_{t+l}$  made at time  $t$  for  $l$  points ahead in time, written as  $\hat{X}_t(l)$ , is given by

$$\hat{X}_t(l) = E(X_{t+l}/H_t) \quad (14)$$

where  $E(X_{t+l}/H_t)$  is the expected value of  $X_{t+l}$  given the past history  $H_t$  of the series up to time  $t$ . Conditional expected values are calculated from the fitted model by replacing unknown  $a$ 's by their expected value which is zero. As an illustration, consider the general discrete process of equation (3). The one-step-ahead forecast made at time  $(t-1)$  can be written as

$$\hat{X}_{t-1}(1) = E(X_t/H_{t-1}) = \mu + \psi_1 a_{t-1} + \psi_2 a_{t-2} + \dots \quad (15)$$

Hence, the one-step-ahead forecast error at time  $(t-1)$  is

$$e_{t-1}(1) = X_t - \hat{X}_{t-1}(1) = a_t \quad (16)$$

which means that the white noise variables generating the process are in fact the one-step-ahead forecast errors. Similarly, the forecast for  $\ell$  units ahead in time is given by

$$\hat{X}_t(\ell) = B^\ell \Psi(B) a_t = \Psi_\ell a_t + \Psi_{\ell+1} a_{t-1} + \dots \quad (17)$$

Confidence intervals for the forecasts can be constructed, assuming that the forecast errors are normally distributed. For a specified  $\alpha$ , the confidence limits are

$$\hat{X}_t(\ell) \pm Z_{\alpha/2} \left(1 + \sum_{i=1}^{\ell-1} \Psi_i^2\right)^{\frac{1}{2}} \cdot S_a \quad (18)$$

where  $S_a$  is an estimate of the standard deviation of the white noise variables and  $Z_{\alpha/2}$  is the deviate exceeded by a proportion of  $\alpha/2$  of the area under the standardized normal distribution.

In addition to making forecasts, the fitted ARMA model can also be utilized to generate simulated rainfall processes with stochastic properties similar to those of the observed data. This can be accomplished by passing a stream of random normal deviates with zero mean and appropriate variance through the estimated filter. The simulated series can then be used as an input to other models to optimize the design of RWCS's.

#### CONCLUSION

The general models discussed in this paper provide a powerful tool for describing the stochastic nature of rainfall processes. Discrete time series models and continuous-time differential equation models can be constructed using uniformly sampled rainfall data. These models are easy to fit, and as a class they are broad enough to virtually represent many forms of dynamic behavior. In conclusion, the models described in this paper should be of use in designing rainwater cistern systems.

#### REFERENCES

- Box, G.E.P., and Jenkins, G.M. 1970. Time series analysis: Forecasting and control. San Francisco, California: Holden Day.
- Box, G.E.P., and Pierce, D.A. 1970. Distribution of residual autocorrelation in autoregressive integrated moving average time series models. In J. Am. Stat. Assoc. 65:1509-1526.
- Fok, Y.S.; Murabayashi, E.T.; and Fong, R.H. 1979. Rainwater roof-catchment cistern system for residential water supply. In Proc. III World Congress on Water Resources, Mexico City, Mexico.



- Fok, Y.S.; Fong, R.H.; Hung, J.; and Murabayashi, E.T. 1980. Bayes-Markov analysis for rain-catchment cisterns. Tech. Rep. No. 133, Water Resources Research Center, University of Hawaii, Honolulu. viii + 100 p.
- Hipel, K.W., and McLeod, A.I. 1978. Preservation of the rescaled adjusted range-3, fractional Gaussian noise algorithms. Water Resour. Res. 14(3): 517-518.
- \_\_\_\_\_, and McLeod, A.I. 1979a. Modeling seasonal geophysical time series using deseasonalized models. Tech. Rep. No. 52-XM-030579, Department of Systems Design, University of Waterloo, Waterloo, Ontario, Canada.
- \_\_\_\_\_, and McLeod, A.I. 1979b. Applied Box-Jenkins modeling for water resources engineers. Amsterdam: Elsevier.
- \_\_\_\_\_; Lennox, W.C.; Unny, T.E.; and McLeod, A.I. 1975. Intervention analysis in water resources. Water Resour. Res. 11(6):855-861.
- \_\_\_\_\_; McLeod, A.I.; Unny, T.E.; and Lennox, W.C. 1977. Intervention analysis to test for changes in the mean level of a stochastic process. In Stochastic Processes in Water Resources Engineering, eds. L. Gottschalk, G. Lindh, and L. Marè, Water Resources Publications, Fort Collins, Colorado, pp. 93-113.
- McLeod, A.I., and Hipel, K.W. 1978a. Preservation of the rescaled adjusted range-1: A reassessment of the Hurst phenomenon. Water Resour. Res. 14(3):491-508.
- \_\_\_\_\_, and Hipel, K.W. 1978b. Developments in monthly autoregressive modeling. Tech. Rep. No. 45-XM-011178, Department of Systems Design, University of Waterloo, Waterloo, Ontario, Canada.
- O'Connell, P.E., and Jones, D.A. 1979. Some experience with the development of models for the stochastic simulation of daily flows. In Inputs for Risk Analysis in Water Systems, ed. E.A. McBean, K.W. Hipel, and T.W. Unny, Water Resources Publications, Fort Collins, Colorado, pp. 287-314.
- Phadke, M.S., and Wu, S.M. 1974. Modeling of continuous stochastic processes from discrete observations with applications to sunspots data. J. Am. Stat. Assoc. 69:325-329.
- Treiber, B., and Plate, E.J. 1977. A stochastic model for the simulation of daily flows. Hydrological Sci. Bull., IAHS 22(1):175-192.
- Weiss, G. 1977. Shot noise models for the generation of synthetic stream flow data. Water Resour. Res. 13(1):101-108.
- Wentworth, C.K. 1959. Rainfall, tanks, catchment, and family use of water. Rep. R13, Hawaii Water Authority, Honolulu, Hawaii.
- Yakowitz, S.J. 1978. A nonparametric Markov model for daily river flows. Technical report, Department of Systems and Industrial Engineering, University of Arizona, Tucson, Arizona.

## STOCHASTIC MODEL OF DAILY PRECIPITATION USING THE TIME SERIES METHODOLOGY

Silvia Vega, Associate Researcher  
 Department of Hydrology  
 Faculty of Civil Engineering  
 University of Yucatan  
 P.O. Box 1423  
 Mérida, Yucatán, MÉXICO

S. Gaona V., Researcher  
 Institute of Physics  
 Universidad Nacional Autonoma de Mexico  
 México 20-364 D.F., MÉXICO  
 Cooperative Program, Researcher  
 Department of Hydrology  
 University of Yucatan  
 Mérida, Yucatán, MÉXICO

### INTRODUCTION

The Yucatán Peninsula, situated in the eastern part of the Mexican Republic (Fig. 1), has geological conditions that necessitate the proper management of its water resources. The aquifer of this peninsula is of the calcareous type (Lesser 1976). Here, the limestone in the study area is covered in some places by just a few centimeters of soil (Gaona, Gordillo, and Villasuso 1980). The area is relatively flat, and there are no rivers and lakes. For this reason, groundwater and precipitation are the only sources of water that can be considered.

In this region, the groundwater has a high content of carbonates and is frequently contaminated by injections of municipal and industrial wastes that infiltrate to the groundwater table. It is for this reason that we consider precipitation as the most viable way to obtain potable water for human consumption. Although rainfall catchment was a very common source of water in the past, the actual design of an adequate system for catchment storage and the management of pluvial water requires more scientific studies.

The first of these studies consists in the development of a statistical model of rainfall by using historical data to plan the tank volume and their catchment areas.

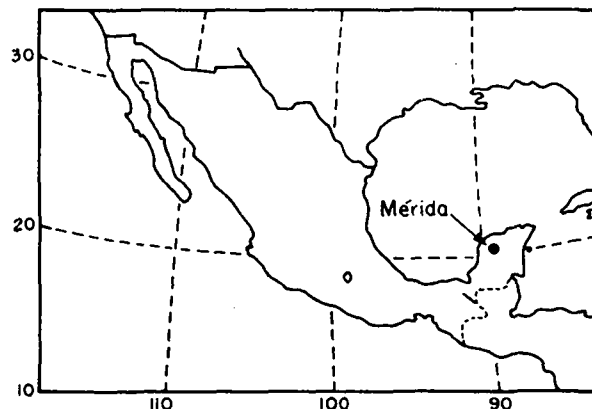

Figure 1. Location of the study area, Mérida, Yucatán Peninsula

Presented here is the statistical analysis of the data and the way in which it will be used to design the cistern, including the results.

The data consist of the daily rainfall-depth measurements corresponding to the past twenty-five years from one of the forty meteorological stations that exist in the Yucatán Peninsula—that which is situated in the city of Mérida. A microprocessor Radio-Shack TRS-80 model was used for the analysis, which was done on a daily basis, to obtain results that can be used in other areas even though it was not necessary for our purpose.

#### METHODOLOGY

The data base has been created and arranged as a time series. The first step of the analysis was to fit a line to the time series, by means of a linear regression. In doing so, one can visualize the existence of any trend by the analysis of the slope of the fitted line, that is, to recognize any general tendency to increase or decrease the given values. To verify the conclusions drawn from this analysis, the Changing Average for Cumulative Records (CACR) and the Changing Trend for Cumulative Records (CTCR) techniques (Shih 1979) were also applied as follows:

Given  $n$  values,  $X_1, X_2, \dots, X_n$  the CACR is performed as

$$X_A(p) = \frac{1}{p} \sum_{i=1}^p X_i \quad p = 2, \dots, n \quad (1)$$

and the CTRC is performed as

$$X_T(p) = \frac{\sum_{i=1}^p X_i(i) - \frac{(p+1)}{2} \sum_{i=1}^p X_i}{\frac{\sum_{i=1}^p X_i^2 - (\sum_{i=1}^p X_i)^2/p}{p}} \quad p = 2, \dots, n. \quad (2)$$

Although there was little variation in the daily averages and trends for the large amount of data from which we worked, the calculations for  $p$  varied month by month.

The data set was divided into five non-overlapping subsets, and an analysis of variance (ANOVA) was performed to confirm that subsets were samples of the same population and to determine the stability of the time series. After the ANOVA was completed, the means and variances of the five subsets were compared by using the Fisher test.

To detect cycles with time periods of the year and its multiples, the correlogram of the time series (Fig. 2) was then obtained by using the formula,

$$r(k) = \text{Cor}(X_i, X_{i+k}) / [\text{Var}(X_i) \text{Var}(X_{i+k})] \quad (3)$$

where

$$\begin{aligned} \text{Cor}(X_i, X_{i+k}) &= \text{autocovariance of the series} \\ \text{Var}(X_i), \text{Var}(X_{i+k}) &= \text{variances of subseries } (X_i) \text{ and } (X_{i+k}) \\ k &= \text{lag number.} \end{aligned}$$

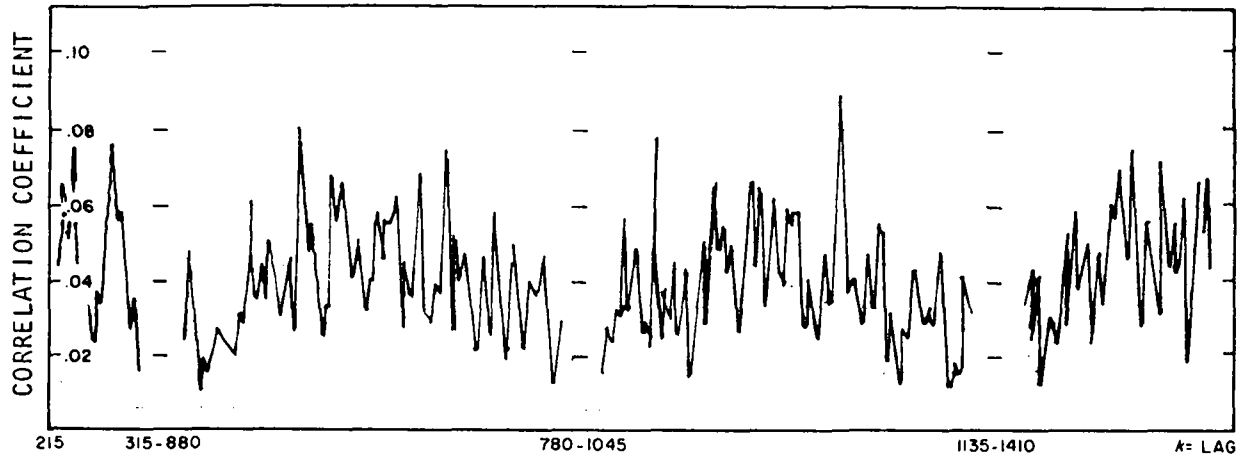

Figure 2. Correlogram

Absence of any cycle with a time period shorter than a year was considered at this step, and the autocorrelation coefficients for 100 days around the 365th day of each year were calculated.

After the completion of the latter analysis, the frequency distribution of the data was accomplished by determining the cumulative relative frequencies for each class interval. The cumulative curve thus obtained is presented in Figure 3.

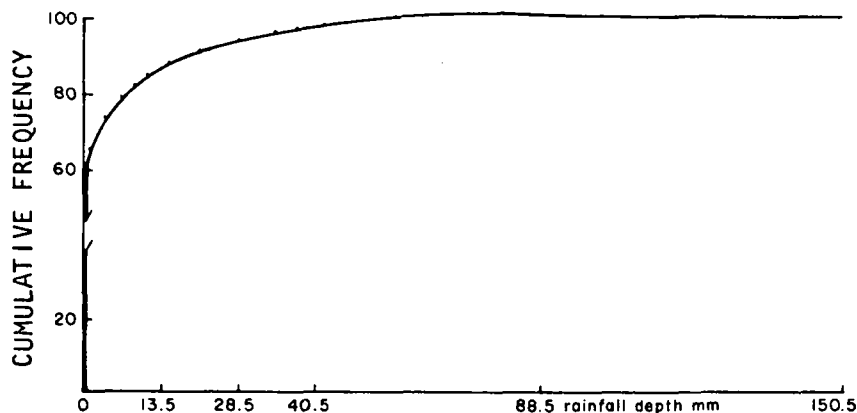

Figure 3. Cumulative rainfall curve

After the analysis of this histogram, some values were eliminated. The values of rainfall depth less than 1.5 mm or greater than 43.5 mm were eliminated and the monthly totals were computed (Table 1). Of the latter, factors considered were that rainfall less than 1.5 mm remain only in the catchment area as humidity and that greater than 43.5 mm has a low occurrence.

The comparison of these totals and the monthly individual water requirements give the design criteria that will be presented in the next paragraphs.

TABLE 1. AVERAGE MEAN OF MONTHLY RAINFALL FOR 25 YEARS AT MÉRIDA STATION, YUCATÁN PENINSULA

MONTH	Average* (mm)	Std. Dev.	Skewness	Kurtosis
1	20.57	20.39	1.12	3.34
2	18.28	20.32	1.71	3.99
3	14.12	20.34	2.18	7.56
4	13.18	19.42	1.62	4.64
5	51.36	34.74	0.82	2.75
6	100.37	52.51	0.70	2.55
7	110.43	33.60	0.36	2.91
8	120.33	48.17	0.19	2.69
9	122.04	51.97	1.51	4.83
10	70.21	38.81	0.84	4.22
11	31.78	30.53	0.88	2.61
12	27.99	28.99	0.95	2.66

\*Excludes rainfall values  $<1.5$  mm and  $\geq 43.5$  mm.

Vega gives detailed descriptions for each of the aforementioned analyses, their justifications and computer programs.

#### DISCUSSION

The statistical analysis can be divided into two parts. In the first part, the data were treated as a time series to determine the stability and reliability of the hydrologic phenomenon. Having done this, the availability of rainfall precipitation was determined in the second part.

Once the linear regression was completed, the value of the slope of the fitted line was determined. This was on the order of  $10^{-5}$  and was found to be not significant after the application of a t-student test because of the absence of a significant trend in our data. This apparent stability was verified when the results of the CACR and CTCR techniques were revised. Both of these techniques were plotted on graphs whose curves approached a horizontal line for some values. When the corresponding plot of the CTCR values reaches zero, this means that any trend, even at a shorter period, can be disregarded. As we will see later, this could be explained as a consequence of the existence of the annual cycle. The correlation coefficient associated with the fitted line to the total data set was very low, as was expected, because of the seasonal, natural variations of the studied phenomenon.

The analyses that we had applied up to this point indicated the reliability of the data. If the data had not been as stable, the existent trend would have had to be studied in a more precise manner to determine its validity and then to eliminate it. These stability analyses were based on a general, as

well as a particular, point of view.

From the analysis of variance (ANOVA) table, we can conclude that in fact the five subsets can be considered samples of the same population, with each having the same mean. In comparing the variances of each of the subsets, the diversification of the factors that need to be considered to model precipitation can be seen. However, for the particular level of this work, we are not interested in a detailed model of daily precipitation.

The degree of reliability obtained through this analysis was considered sufficient to use the statistical data without correction.

The correlogram of time plotted by groups in Figure 2, as previously stated, indicates the existence of only one cycle, the annual cycle. There is no sign of another cycle with different time periods.

All of the previous results indicate that the historical record can be used to determine a reliable criteria for the design of the rain water cistern system.

The daily precipitation data were classified according to class intervals and their relative frequencies were plotted in Figure 3, where we can see that 80% of the data is less than 1.5 mm—a point that is important in the designing of a rain water cistern system since it would barely moisten a catchment area. Precipitation data of more than 43.5 mm has an occurrence probability of less than .01, which should not be considered when establishing the criteria. The remaining 19% of the data will be used to establish the design criteria.

#### DESIGN CRITERIA

With the results obtained from the stochastic model, the size of the catchment area or the storage volume must be determined.

To always ensure adequate water supply from storage, let  $w_i$  be the monthly amount of precipitation,  $a$  the catchment area and  $c$  the monthly individual consumption, as

$$\sum_{i=1}^{12} (w_i a - c) > 0 \quad (4)$$

$$a \cdot \sum_{i=1}^{12} w_i > 12c \quad (5)$$

$$a > 12c/w_i \quad (6)$$

In this case we assume that  $c = 2.5 \text{ dm}^3$  and that we have  $w_i = 323 \text{ m}$ , and by substituting we obtain  $a > 2.78 \text{ m}^2$ .

Figure 4 shows the monthly available water volume in storage, assuming a catchment area of  $3 \text{ m}^2$  and  $75 \text{ dm}^3$  of monthly consumption. In this graph, the water consumption was considered constant during the year, and the monthly possibility of rain as the difference between the average and its standard deviation. These two figures are not the best that could be used in the model, but was what was done until now.

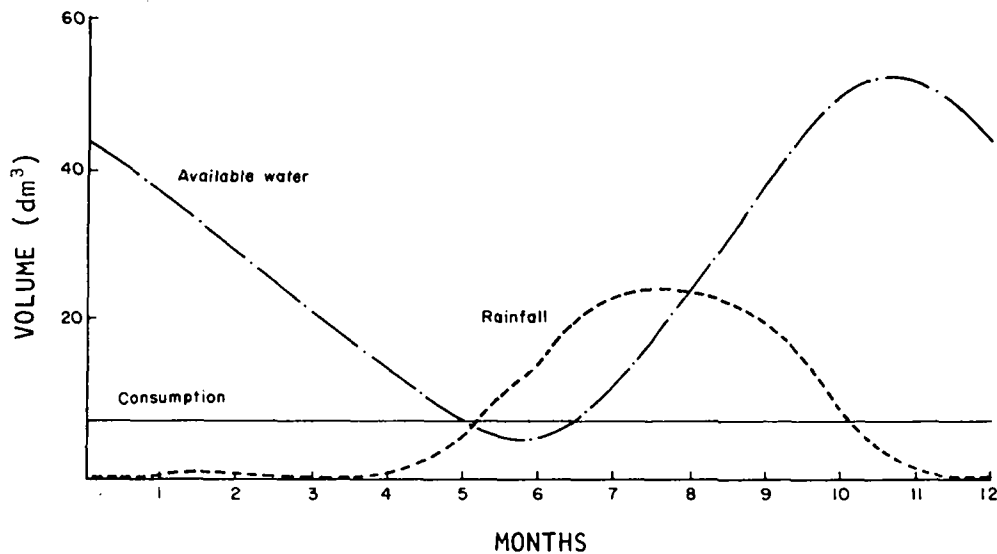

Figure 4. Expected operation of the system

Figure 4 shows that in each season potable water is obtainable throughout the year, and that a  $3 \text{ m}^2$  catchment area and  $500 \text{ dm}^3$  storage are acceptable values for local conditions.

#### ACKNOWLEDGMENTS

We thank professors Tuchée Gordillo and Arturo Gamietea for their helpful comments and discussion of the results; the engineers Mario Gomez and Luiz Moreno for their technical suggestions, and Jorge Tun for gathering the data; and Humberto Bilio E. from the Observatoria Metereologico y Radiozondeo viento of Mérida, Yucatán for the data.

In addition, we appreciate the economic support of the Dirección General de Investigación Científica y Superación Académica from the Mexican Ministry of Education, the University of Yucatan and the Institute of Física of the National University.

#### REFERENCES

- Gaona, S.; T. Gordillo de A.; M. Villasuso P. 1980. Algunas características del karst de la Península de Yucatán. In IV Congreso Nacional de Hidráulica II, Sociedad Mexicana de Hidráulica, at Mérida, México, 15-19 November 1980, pp. 547-554.
- Lesser, J.M. 1976. Estudio hidrogeológico e hidrogeoquímico de la Península de Yucatán. Tech. Rep., Dirección de Geohidrología y Zonas Áridas, SRH México. vi + 64 p.
- Shih, S.F. 1979. Techniques to solve the hydrologic trend and cyclic movements. In III World Congress on Water Resources, International Water Resources Association, at Mexico City, vol. V, pp. 2026-2035.

Vega, S. 1981. "Modelo estocastico de la precipitación pluvial sobre la ciudad de Mérida: Análisis por series de tiempo." Bachelor's thesis, Universidad de Yucatán, México. 57 p.



## ESTIMATION OF EXTREME POINT RAINFALL OVER PENINSULAR INDIA

O.N. Dhar, Assistant Director  
 Indian Institute of Tropical Meteorology  
 Pune-411005, INDIA

P.R. Rakhecha, Sr. Science Officer                      A.K. Kulkarni, Jr. Science Officer  
 Indian Institute of Tropical Meteorology  
 Pune-411005, INDIA

### INTRODUCTION

In November 1980, the United Nations launched an International Drinking Water and Sanitation Decade (1981-1990) to focus world-wide attention on providing safe drinking water. In India there are still villages and towns in various parts of the country where people have to carry water from long distances for their daily use in spite of the fact that we have tremendous water resources which are replenished year after year by rainfall during the monsoon months.

It has been estimated that the average annual rainfall of the contiguous Indian area is about 117 cm of which about 76% is received during the four monsoon months of June to September (Dhar, Rakhecha, and Kulkarni 1979). This much rainfall is estimated to generate annually a surface flow on the order of 1 881 bil m<sup>3</sup> (Murthy 1977). Apart from this, this country has groundwater resources which are on the order of 350 mil m<sup>3</sup>.

Because the main goal of the International Drinking Water and Sanitation Decade is to provide safe drinking water in sufficient quantity, an attempt has been made in this study to find out what the maximum probable rainfall or the extreme rainfall is that a station can get in the peninsular region of this country. This information, would not only be useful in knowing the extreme amount of rainfall that is physically possible over a station or a basin, but is also useful for the safe design of hydraulic structures that may be constructed for conservation of water in this region of India.

### EXTREME RAINFALL AND HOW TO ESTIMATE IT

Extreme rainfall, which is also known as probable maximum precipitation (hereafter abbreviated as PMP), is defined as the highest rainfall that is physically possible over a given point or a specified area for a certain duration. Another definition of PMP which is operational in nature, states that PMP is that magnitude of rainfall which will yield flood flows of which there is virtually no risk of being exceeded (Myers 1967).

### ESTIMATION OF PMP BY MOISTURE MAXIMIZATION TECHNIQUE

Normally, PMP estimates are used in the design of hydraulic structures for which no risks regarding their failure can ever be taken. Generally, such hydraulic structures which are built upstream of large towns or industrial areas are designed for PMP because no risks can be taken regarding their

safety. As such, a design storm of PMP magnitude is obtained on the basis of moisture maximization of the most severe rainstorm in and around a problem basin under consideration. However, in recent years, doubts have been expressed as to whether the moisture maximization technique, which has been developed for the middle (or temperate) latitudes for obtaining PMP estimates, is at all relevant for tropical regions like India where a plentiful supply of rainfall precipitation is available especially during the monsoon months. Since no other suitable physical technique has so far been developed to replace the moisture maximization technique for tropical regions, it is felt that the statistical technique developed by Hershfield (1961) may be used as it is mainly based on the statistical analysis of observed long-period rainfall data of a station or a basin. Hence, in this study, the Hershfield technique has been used for the estimation of PMP for the peninsular region of India.

#### APPRAISAL OF PMP ESTIMATES OBTAINED BY HERSHFIELD TECHNIQUE

Hershfield (1961, 1965) proposed a statistical approach for the estimation of PMP. Preliminary appraisal of the technique in the U.S.A. (Myers 1967) and in Canada (Bruce and Clark 1966, pp. 233-235) has shown that PMP estimates obtained by this approach are closely comparable to those obtained by the conventional moisture maximization method. The World Meteorological Organization (WMO) in their various technical publications (WMO 1969, 1970, 1973, 1976) have suggested this method for estimating extreme rainfall for those river basins whose daily rainfall data are available for a long period of time; however, data of storm maximization are lacking. Wiesner (1970, pp. 222-224) feels that this method has the advantage of taking into account the actual rainfall data, expressing it in terms of statistical parameters and is quite easy to use. Recently, Mejia and Villegas (1979) have applied this method to stations in Colombia having long-period rainfall data.

In India, Dhar and Kulkarni (1970) used this technique (Hershfield 1961, 1965) to prepare a generalized one-day PMP chart for the plains of north India on the basis of about 1000 long-period stations. Recently, Dhar, Kulkarni, and Rakhecha (1981) prepared a similar generalized one-day PMP chart for the southern half of the Indian peninsula lying between 8° to 16° north latitudes. In the present investigation, the PMP study has been extended to cover the entire peninsular region lying between 8° to 20° north latitudes using long-period rainfall data of about 860 stations.

#### HERSHFIELD TECHNIQUE

Hershfield used Chow's (1951) general formula for frequency analysis of extreme values in the following form for obtaining PMP estimates:

$$X_{\text{PMP}} = \bar{X}_n + S_n \cdot K_m \quad (1)$$

where  $X_{\text{PMP}}$  is the probable maximum precipitation for a given station,  $\bar{X}_n$  is the mean and  $S_n$  the standard deviation for a series of  $n$  annual maximum rainfall values of one day duration, and  $K_m$  is the frequency factor which depends upon the number of years of record and, consequently, the return period.

The frequency factor,  $K_m$ , for a station was obtained by using the equa-

tion,

$$K_m = (X_1 - \bar{X}_{n-1})/S_{n-1} \quad (2)$$

where  $X_1$  is the highest value for a series of  $n$  annual maximum rainfall values,  $\bar{X}_{n-1}$  and  $S_{n-1}$  are the mean and standard deviation for a series of  $(n-1)$  annual maximum rainfall values of one-day duration excluding the highest value of  $X_1$ .

Hershfield worked out  $K_m$  values based upon annual maximum rainfall records of about 2650 stations in the U.S.A. and elsewhere and proposed an upper value of  $K_m = 15$  to obtain the PMP for a one-day duration.

Several workers (Wilson 1963; Mazumdar and Ranga Rajan 1966) questioned the universal applicability of  $K_m = 15$ . In India, Dhar and Kamte (1969, 1971, 1973) have argued that since different meteorological divisions of the country have their own distinct rainfall characteristics, it is desirable to obtain  $K_m$  values for each division on the basis of their actual long-period rainfall data. Accordingly, in a number of their studies on PMP for different parts of the country, Dhar and Kamte (1969, 1971, 1973) have used respective regional envelope values of  $K_m$  to obtain realistic estimates of PMP.

#### MODIFIED HERSHFIELD TECHNIQUE

Initially, Hershfield (1961) considered the  $K_m$  value as being independent of the mean annual maximum rainfall magnitude (i.e.,  $\bar{X}_n$ ). Later, he found that as  $\bar{X}_n$  increased in magnitude,  $K_m$  values had a tendency to decrease. Thus, the value of  $K_m = 15$  was found to be high for heavy rainfall areas and low for arid areas (WMO 1973). Subsequently, Hershfield (1965) prepared the envelope  $K_m$  curve for obtaining  $K_m$  values for different values of  $\bar{X}_n$ . Dhar and Kamte (1973), used this modified approach for preparing a generalized PMP chart of the Brahmaputra basin in northeast India. They also used this very approach in their PMP studies of different parts of this country (Dhar, Kulkarni, and Sangam 1975a; Dhar and Kulkarni 1975b). This modified approach has been used in the present study for the preparation of a generalized PMP chart for the entire southern half of the Indian peninsula south of  $20^\circ$  north latitude.

#### ANALYSIS OF DATA AND PROCEDURE USED

The data of yearly observed one-day maximum rainfall for about 860 long-period stations distributed uniformly over the area under study were analyzed. The length of data record varies from 70 to 80 years at each of these stations. The values of  $\bar{X}_n$ ,  $\bar{X}_{n-1}$ ,  $S_n$ ,  $S_{n-1}$  and the coefficient of variability (CV) were calculated for all 860 stations by using the appropriate computer programs. The  $K_m$  values for each individual station were determined by using equation (2). When these values were plotted on a large-scale base map of this region, it was found that  $K_m$  values were randomly distributed and did not show any geographical pattern.

Following the modified technique of Hershfield (1965),  $K_m$  values for 860 stations were plotted against  $\bar{X}_n$  and an envelope  $K_m$  curve for the entire region was drawn. Figure 1 shows the relationship of the  $K_m$  values with the mean annual maximum one-day rainfall (i.e.,  $\bar{X}_n$ ). The equation of the envelope

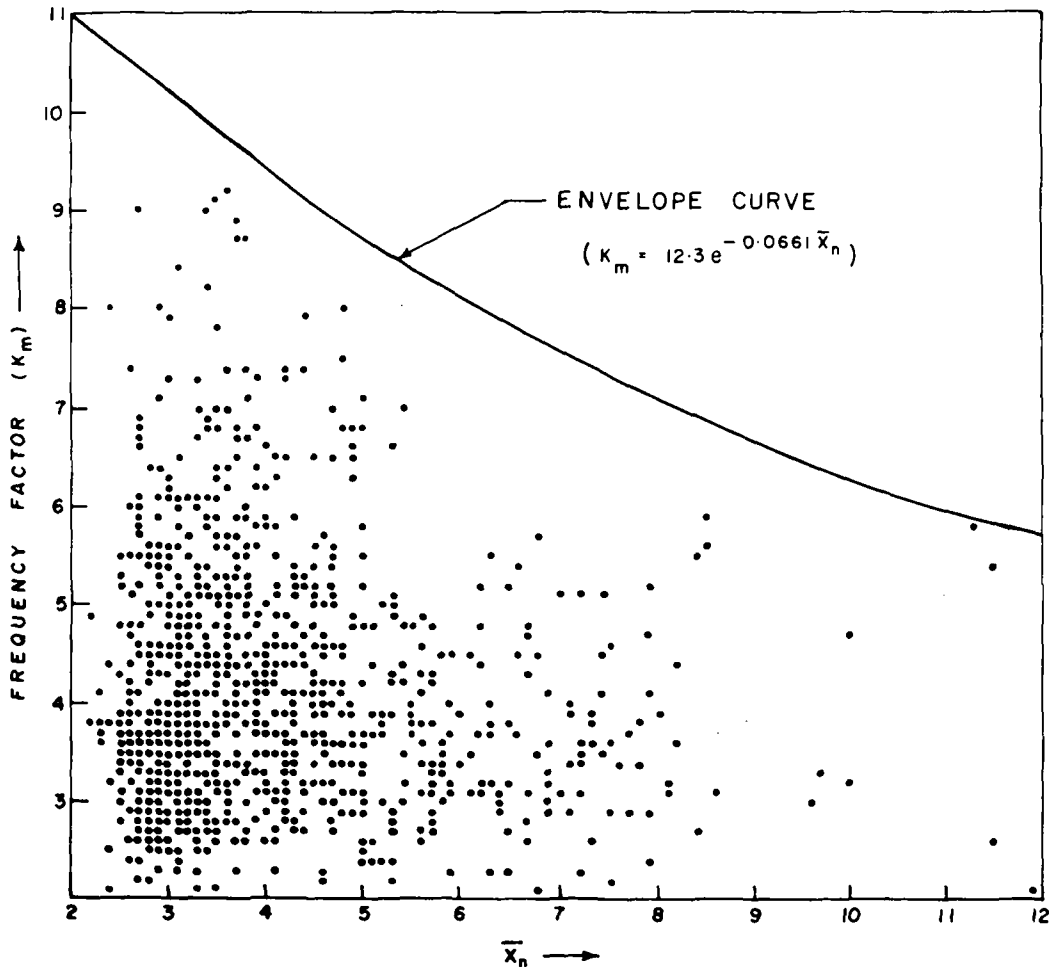

Figure 1. Relationship between frequency factor ( $K_m$ ) and mean annual maximum rainfall ( $\bar{x}_n$ ) for one-day rainstorm duration

curve, which incorporates relationship between the frequency factor ( $K_m$ ) and the mean annual rainfall ( $\bar{x}_n$ ), worked out to be  $K_m = 12.3 e^{-0.0661 \bar{x}_n}$ . This equation was used to obtain  $K_m$  values for different values of  $\bar{x}_n$ . Using these  $K_m$  values for each of the stations, PMP values were computed using equation (1).

#### PREPARATION OF A GENERALIZED PMP CHART

Before preparing the generalized PMP chart for the peninsular region of India, the coefficient of variation [ $CV = (S_n/\bar{x}_n) \times 100$ ] values for all the 860 rainfall stations were plotted on a large-scale base map of the region to smooth out the inherently large errors associated with standard deviations (Hershfield 1961). On this map the CV values for nearby stations were compared and, wherever necessary, the CV values were adjusted and standard deviation ( $S_n$ ) values were recalculated. Using the revised standard deviation values, PMP estimates were recomputed for those stations whose  $S_n$  values were adjusted. Figure 2 shows the isohyetal pattern of a one-day PMP generalized chart. It is seen from this chart that one-day PMP estimates over the penin-

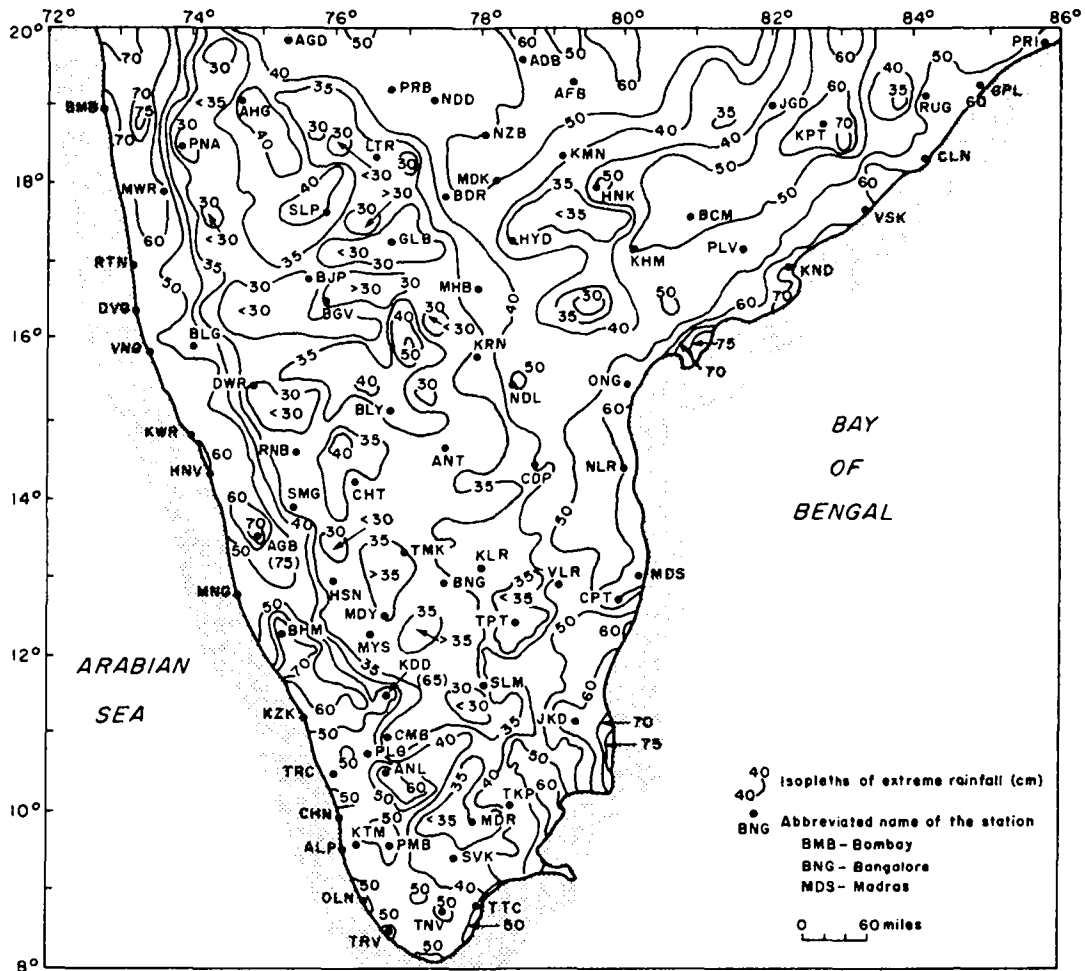

Figure 2. Generalized chart of one-day extreme rainfall (cm) over Indian peninsular

sular region of India range from about 30 to 85 cm.

#### DISCUSSION OF PMP GENERALIZED CHART

The isohyetal pattern of PMP over a region, like rainfall, depends upon the physical features or the orography of the region. Figure 2 shows that high values of PMP were obtained along the east and west coasts of the peninsula. The high values along and near the west coast are mainly due to the rugged topography of the Western Ghats, while the high values along the east coast are due to the movement and landfall of cyclonic disturbances from the Bay of Bengal.

The highest one-day PMP values on the order of 75 and 85 cm were respectively obtained for the two rainiest stations of the Agumbe and Bhagamandala regions (Dhar, Mandal, and Ghose 1978). The central belt of the peninsula is also seen as having comparatively low PMP values on the order 30 to 40 cm. On the 25th of July 1924, Bhagamandala recorded the highest one-day rainfall of 84 cm which appears to be of near PMP magnitude.

## CONCLUSIONS

About 860 long-period rainfall stations, whose daily rainfall data are continuously available for the last 70 to 80 years from 1891, have been used for the preparation of a generalized PMP chart of one-day duration for the peninsular region of India from  $8^{\circ}$  to  $20^{\circ}$  north latitudes. This study has shown that extreme one-day point rainfall over this region can vary from about 30 to about 85 cm in one day. It is also seen that stations along and near the western and eastern coasts of the peninsula can have very high values of PMP ranging from 50 to 85 cm. In this entire region of Bhagamandala, a station in the Coorg District of Karnataka, was found to have the highest PMP value (i.e., 85 cm) in one day. Stations located in the central parts of the peninsula have the lowest values of PMP ranging from 30 to 40 cm in one day.

## ACKNOWLEDGMENT

The authors are grateful to Dr. Bh. V. Ramana Murthy, Director, Indian Institute of Tropical Meteorology, Pune-5, for his encouragement and keen interest in hydrometeorological studies. Thanks are due to Mr. M.K. Soman and Mr. R.B. Sangam, Senior Scientific Assistants of the Hydromet Research Project for their help in the compilation and computation of rainfall data and to Mr. V.V. Savargaonkar for typing the original draft manuscript.

## REFERENCES

- Bruce, J.P., and Clark, R.H. 1966. *Introduction to hydrometeorology*. New York; Pergamon Press.
- Chow, V.T. 1951. A general formula for hydrologic frequency analysis. *Trans. Am. Geophys. Union* 32(2):231-237.
- Dhar, O.N., and Kamte, P.P. 1969. A pilot study for the estimation of probable maximum precipitation using Hershfield technique. *Indian J. Meteorol. and Geophys.* 20(1):31-34.
- Dhar, O.N., and Kulkarni, A.K. 1970. Estimation of extreme and maximum one-day point rainfall of different return periods over Punjab, Haryana and Delhi. In *Proc. Flood Forecasting Control and Flood Damage Protection*, India Pub. No. 107, CBI&P. New Delhi, pp. 126-141.
- Dhar, O.N., and Kamte, P.P. 1971. Estimation of extreme rainfall over north India. *Indian J. Meteorol. Geophys.* 22(3):559-566.
- Dhar, O.N., and Kamte, P.P. 1973. Probable maximum precipitation in the Brahmaputra basin in Assam. *Irrig. Power J.* 30(3):237-241.
- Dhar, O.N.; Kulkarni, A.K.; and Sangam, R.B. 1975a. A study of extreme point rainfall over flash flood prone regions of the Himalayan foothills of north India. *Hydrological Sciences Bull.* 20(1):61-67.
- Dhar, O.N., and Kulkarni, A.K. 1975b. Estimation of probable maximum precipitation for some selected stations in and near the Himalayas. In *Proc. National Symposium on Hydrology*, University of Roorkee, pp. G12-16.

- Dhar, O.N.; Mandal, B.N.; and Ghose, G.C. 1978. Heavy rainfall stations of India—A brief appraisal. *Indian J. Power and River Valley Development* 28(2):47-53.
- Dhar, O.N.; Rakhecha, P.R.; and Kulkarni, A.K. 1979. Rainfall study of severe drought years of India. In *Proc. Symp. Hydrological Aspects of Droughts*, New Delhi, India, pp. 363-372.
- Dhar, O.N.; Kulkarni, A.K.; and Rakhecha, P.R. 1981. Probable maximum point rainfall estimation for the southern half of the Indian peninsula. *Proc. Indian Academy of Sciences (Earth Planet. Sci.)* 90(1):39-46.
- Hershfield, D.M. 1961. Estimating the probable maximum precipitation. *J. Hydraul. Div., Am. Soc. Civ. Eng.* 87(HYt):99-116.
- Hershfield, D.M. 1965. Method for estimating probable maximum precipitation. *J. Am. Water Works Assoc.* 57(8):965-972.
- Mazumdar, K.C., and Ranga Rajan, R. 1966. Regional storm analysis. *Indian J. Meteorol. Geophys.* 17(Spec. No.):79-86.
- Mejia, G., and Villegas, F. 1979. Maximum precipitation deviations in Colombia. In *Proc. Third Conference on Hydrometeorology*, Bogota, Colombia. Am. Meteorol. Soc. publication.
- Murthy, Y.K. 1977. Water resources development in India and its related problems. *Hydrology Review, J. Ind. Nat. Com.IHP* 3(1&2):23-39.
- Myers, V.A. 1967. Meteorological estimation of extreme precipitation for spillway design flood. *WBTM Hydro.* 5:20-21, U.S. Weather Bureau.
- Wiesner, C.J. 1970. *Hydrometeorology*. London: Chapman and Hall.
- Wilson, W.T. 1963. Discussion on paper No. 3431. Estimating probable maximum precipitation. *Trans. Am. Soc. Civ. Eng.* 128(pt. 1):552-554.
- World Meteorological Organization. 1969. Estimation of maximum floods. Tech. Note. 98, WMO, No. 233, TP. 126, pp. 78-80.
- World Meteorological Organization. 1970. Guide to hydrometeorological Practices. No. 168, WMO, TP. 82, p. A.16.
- World Meteorological Organization. 1973. Manual for estimation of probable maximum precipitation. No. 332, WMO, pp. 95-107.
- World Meteorological Organization. 1976. The quantitative evaluation of the risk of disaster from tropical cyclones. Spec. Environ. Rep. No. 8, WMO, No. 455, pp. 46-47.

## FREQUENCY DISTRIBUTION OF WEEKLY RAINFALL AT BAHADRABAD, INDIA

S.M. Seth, Scientist E  
National Institute of Hydrology  
Roorkee, INDIA

Jagdish Mohan, Research Officer  
U.P. Irrigation Research Institute  
Roorkee, INDIA

S.S. Tiagi, Asst. Research Officer  
U.P. Irrigation Research Institute  
Roorkee, INDIA

### INTRODUCTION

The state of Uttar Pradesh, which is extremely diverse in topography, climate and vegetation, ranks fourth in area and first in population in India. Because of the rapid growth in population, intensive urbanization and industrialization is taking place in the basically agricultural areas in the foothill regions of the Himalayas. Rainfall in this region occurs during the monsoon months of June to October with most of it occurring July and August, with some rainfall during the non-monsoon months. During the monsoon season, there is considerable variation in rainfall in time and space. To provide information regarding expected levels of rainfall at different time for planning drainage requirements, the analysis of statistical characteristics of rainfall in the area is necessary.

The meteorological observatory at Bahadrabad, established in 1952, is situated at 29°55.5' east latitude and 78°2.25' north longitude at an elevation of 275 m above mean sea level. Its climatic observations are representative of the foothill region of the Ganga-Yamuna interbasin. The observatory is equipped with recording and non-recording types of rain gauges. The weekly rainfall for 1955 to 1980 for the monsoon season (1 June-1 November) has been used in the present study. The maximum weekly rainfall of 395.7 mm during this period occurred in the week of 3 to 9 August 1978.

### FREQUENCY ANALYSIS

One of the earliest and most frequent statistical method used in hydrology has been that of frequency analysis—a procedure for estimating the probability of occurrence of past and future events. Early applications of frequency analysis were most often used for flood estimation. Today, nearly every phase of hydrology is subjected to frequency analysis. Typical statistical distributions are suitable for application in particular situations (Chow 1964).

For this study of weekly rainfall frequency analysis, normal, square root, and normal and log normal distributions have been used. The normal distribution is a symmetrical distribution with the density function of

$$F(x) = \frac{1}{\sigma \sqrt{2\pi}} e^{-\frac{1}{2} \left( \frac{x-\mu}{\sigma} \right)^2}$$



for

$$-\infty < x < +\infty$$

where  $\mu$  is the arithmetic mean and  $\sigma$  is the standard deviation. In the case of the square root normal distribution, the random variable  $x$  is transformed to  $y$  using equation  $y = \sqrt{x}$ , and for the log normal distribution the transformation is  $y = \log_e x$ . The values of  $y$  are tested for fit of normal distribution.

**SKEWNESS.** The skewness coefficient  $C_s$  which is also referred to as skewness, is given by  $C_s = (\alpha/\sigma^3)$  where  $\alpha = \int_{-\infty}^{\infty} (x - \mu)^3 F(x) dx$ . For a symmetrical distribution,  $C_s = 0$ . A distribution with a long tail to the right is said to be skewed to the right and has  $C_s > 0$ , while the distribution with a long tail to the left is said to be skewed to the left and has  $C_s < 0$ . The goodness of fit of data to statistical probability distribution has been tested using the chi-square test.

**CHI-SQUARE TEST.** Let the sample space be divided into mutually exclusive groups or classes and  $P_i$  be the probability that the variable belongs to the  $i$ th group according to the assumed distribution with calculated parameters. If  $X^i$  and  $X^{i+1}$  are the limits of the  $i$ th class interval, then  $P_i = F(x^{i+1}) - F(x^i)$ . Let  $F_i$  be the observed frequency of the sample from the  $i$ th group and be the total number of samples. The chi-square statistic is defined as

$$\chi^2 = \sum_{i=1}^{\gamma} \frac{(F_i - N P_i)^2}{N P_i}$$

and  $k$  is the number of parameters estimated. Then, theoretically, chi square has a specific distribution known as the chi-square distribution with  $\gamma - k - 1$  degrees of freedom. Let  $\chi_p^2$  denote the value of chi square at the  $P\%$  level. For the given degrees of freedom,  $\chi_p^2$  can be obtained from statistical tables. If the calculated value of chi square is greater than  $\chi_p^2$  obtained from the tables, then the sample deviates significantly from the assumed distribution at the given level and the fit is not good. If, however,  $\chi_p^2 < \chi_p^2$ , the fit is satisfactory at the given level and may be adopted for design purposes.

A computer program was developed for testing the best fit of the three distributions mentioned above. The program was run on the Roorkee University DEC 2050 computer. Expected rainfall values for nonexceedence probabilities  $P(X \leq x)$  of 50, 75, 90, 95 and 99% have been respectively computed for the three distributions for each of the 22 weeks. The values are given in Tables 1 to 3 along with values of mean, standard deviation and chi square for the particular distribution.

## DISCUSSION OF RESULTS

The coefficient of skewness for each week and for each of the three statistical distributions have been plotted in Figure 1. It may be seen that for the original data without any transformation, the skewness is generally more than +0.8 and reaches a value of more than 4.0 in the month of October. With log transformation of the data, the skewness coefficient becomes negative and

TABLE 1. NORMAL DISTRIBUTION OF WEEKLY RAINFALL  
FREQUENCY ANALYSIS, UTTAR PRADESH, INDIA

WK. NO.	MEAN	STD. DEV. (mm)	CHI SQUARE	EXPECTED VALUES FOR NONEXCEDENCE PROBABILITIES $P(X \leq x)$ (mm)				
				Percent				
				50	75	90	95	99
1	13.75	24.31	48.06	13.75	30.04	44	53	70
2	18.99	25.54	42.54	18.99	36.10	51	61	78
3	26.74	48.54	23.54	26.74	59.26	88	106	139
4	41.99	35.74	3.69	41.99	65.93	87	100	125
5	59.08	61.45	18.86	59.08	100.25	137	160	202
6	74.97	50.04	1.23	74.97	108.50	139	157	191
7	93.97	77.17	4.67	93.97	145.67	192	221	273
8	99.25	93.32	9.69	99.25	161.77	218	253	316
9	101.47	64.64	5.84	101.47	144.77	184	208	252
10	105.95	104.90	22.27	105.95	176.23	240	279	350
11	68.98	51.15	0.90	68.98	123.18	134	153	188
12	83.83	54.31	3.34	83.83	120.22	153	173	209
13	64.00	55.35	2.13	64.00	101.08	135	155	192
14	42.64	52.27	18.41	62.64	77.66	107	128	164
15	45.07	32.73	2.48	45.07	67.10	86	98	121
16	46.29	71.15	31.49	46.29	93.96	137	167	192
17	26.04	46.00	24.60	26.04	56.86	80	101	133
18	18.85	47.98	73.58	18.85	51.00	80	98	129
19	20.33	49.00	52.00	20.33	53.16	83	101	134
20	9.17	22.56	57.35	9.17	24.28	38	46	61
21	2.69	7.93	64.58	2.69	8.00	12	15	21
22	3.62	10.67	82.41	3.62	10.77	17	21	28

TABLE 2. NORMAL DISTRIBUTION-SQUARE ROOT TRANSFORMATION OF WEEKLY RAINFALL FREQUENCY ANALYSIS, UTTAR PRADESH, INDIA

WK. NO.	MEAN (mm)	STD. DEV. (mm)	CHI SQUARE	EXPECTED VALUES FOR NONEXCEDENCE PROBABILITIES $P(X \leq x)$ (mm)				
				Percent				
				50	75	90	95	99
1	2.13	3.09	42.37	4.54	17.72	37	51	87
2	2.92	3.30	31.93	8.53	26.48	51	69	112
3	3.78	3.59	6.41	14.29	38.46	70	93	147
4	5.75	3.05	2.44	33.06	60.95	93	115	165
5	6.64	3.95	2.60	44.09	86.56	136	172	251
6	8.09	3.15	0.42	65.45	104.34	147	176	238
7	8.83	4.09	1.66	77.96	134.29	198	242	337
8	8.80	4.76	1.31	77.44	144.25	222	276	395
9	9.35	3.81	7.36	87.42	142.08	202	243	232
10	9.03	5.03	4.29	81.54	154.32	239	299	430
11	7.63	3.35	0.90	58.20	97.80	142	172	238
12	8.63	3.11	1.74	74.48	115.08	159	188	252
13	7.15	3.65	0.39	51.12	92.39	139	173	245
14	5.29	3.90	0.90	27.09	62.73	105	137	206
15	6.01	3.04	1.93	36.12	64.97	98	121	171
16	4.88	4.83	14.00	23.81	66.22	122	164	206
17	3.36	3.91	18.08	11.29	35.96	70	95	155
18	2.33	3.74	23.20	5.43	23.54	50	71	121
19	2.82	3.59	24.06	7.95	27.47	55	76	125
20	1.46	2.71	62.49	2.13	10.81	24	35	60
21	0.69	1.51	58.81	0.47	2.92	6	10	17
22	0.69	1.81	73.58	0.47	3.65	9	13	24

TABLE 3. LOG NORMAL DISTRIBUTION OF WEEKLY RAINFALL  
FREQUENCY ANALYSIS, UTTAR PRADESH, INDIA

WK. No.	MEAN (mm)	STD. DEV. (mm)	CHI SQUARE	EXPECTED VALUES FOR NONEXCEDENCE PROBABILITIES $P(X \leq x)$ (mm)				
				Percent				
				50	75	90	95	99
1	-1.46	3.86	46.19	0.23	2.72	32	132	1878
2	-0.46	4.01	26.77	0.63	9.41	108	467	7258
3	0.95	3.56	24.61	2.58	28.61	248	904	10408
4	2.92	2.09	16.51	18.60	76.31	272	582	2437
5	3.17	2.09	11.28	23.89	98.01	349	704	3130
6	3.81	1.85	18.43	45.34	158.49	486	951	3391
7	7.05	1.33	7.98	57.66	141.96	316	511	1284
8	3.82	2.04	11.13	45.98	180.51	630	1310	5322
9	3.85	2.55	64.58	47.20	264.08	1246	3130	18051
10	4.05	1.28	2.47	57.66	136.39	297	476	1138
11	3.65	1.89	14.21	38.63	137.76	435	869	3162
12	4.15	0.89	1.84	63.73	116.20	199	274	506
13	3.44	1.96	15.58	31.30	117.37	386	746	3007
14	2.27	2.86	10.48	9.70	67.00	382	1072	7631
15	2.88	2.48	21.32	17.87	95.12	431	1061	5823
16	1.71	3.03	2.84	5.53	42.70	272	810	6501
17	0.17	3.79	17.37	1.18	15.38	153	606	8185
18	-1.00	3.67	27.05	0.36	4.35	40	155	1916
19	-0.48	3.96	42.18	0.61	8.95	100	418	6373
20	-2.34	3.53	69.35	0.09	1.04	8	32	360
21	-3.09	2.86	85.44	0.04	0.14	2	4	35
22	-3.39	2.70	65.77	0.03	0.20	1	2	18

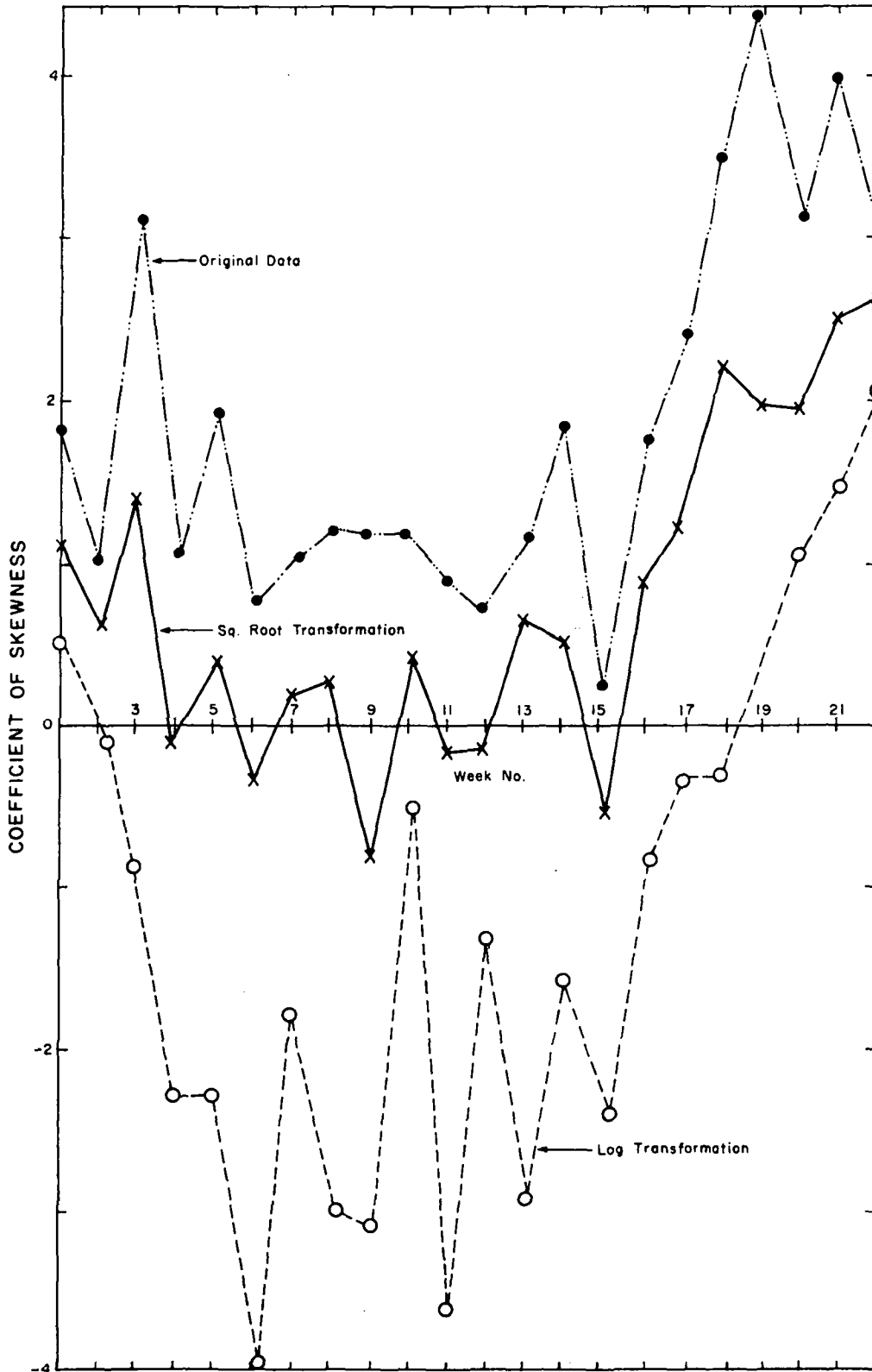

Figure 1. Coefficient of skewness for different transformations

for one or two weeks its value lies between -1 to -4. The square root transformation of the data gives skewness coefficient values between -0.5 to +0.5, particularly during the fourth to fifteenth week of the monsoon period where most of the rainfall is concentrated. The comparison of skewness coefficient for three cases indicates generally that for the week of numbers 4 to 15, the square root normal distribution should give the best fit. The results presented in Tables 1 to 3 confirm the above indications.

The rainfall in week numbers 4 to 15 is important for the planning and design of drainage structures. Using the best-fit distribution, i.e., that having the least value of chi square out of three distributions, the expected weekly rainfall (in mm) has been plotted for nonexceedence probabilities  $P(X \leq x)$  of 50, 75, 90, 95 and 99% in Figure 2. The mean rainfall values for these weeks, as computed from the original data, are also plotted for comparison. Figure 2 provides a composite diagram for designers and planners of drainage systems in the foothill region of Western Uttar Pradesh. The ratio of expected weekly rainfall and the arithmetic mean have also been tabulated (Table 4) for week numbers 4 to 15 for nonexceedence probabilities of 75, 90, 95 and 99%. The maximum value of this ratio occurs in the tenth week, except for the 75% probability. For this week, the log normal distribution is the best fit.

TABLE 4. RATIO OF EXPECTED RAINFALL AND MEAN FOR DIFFERENT NONEXCEEDENCE PROBABILITIES, UTTAR PRADESH, INDIA

WK. NO.	EXPECTED RAINFALL/MEAN FOR $P(X \leq x)$			
	Percent			
	75	90	95	99
4	1.45	2.22	2.76	3.94
5	1.46	2.32	2.92	4.25
6	1.39	1.96	2.40	3.18
7	1.43	2.11	2.57	3.58
8	1.45	2.04	2.79	3.99
9	1.42	1.81	2.05	2.48
10	1.28	2.81	4.50	10.75
11	1.41	2.06	2.53	3.45
12	1.38	1.89	2.25	3.06
13	1.44	2.18	2.70	3.88
14	1.47	2.48	3.26	4.84
15	1.44	2.18	2.68	3.80

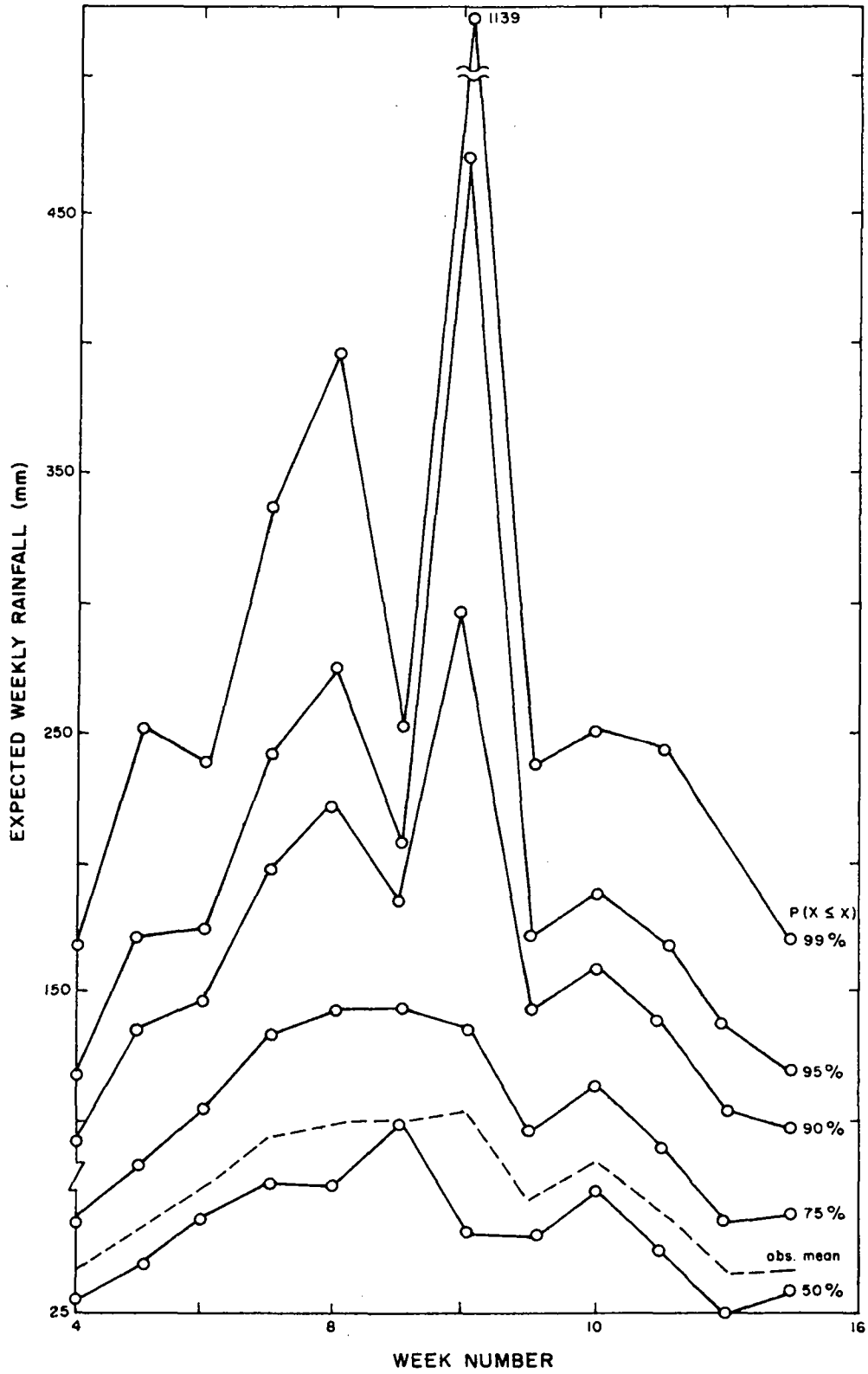

Figure 2. Expected weekly rainfall for week numbers 4 to 5

### CONCLUSIONS

The frequency analysis technique has been used for expected values of weekly rainfall with different nonexcedence probabilities. It has been found that for most of the weeks, the square root normal distribution is the best fit. For the ninth and tenth weeks having heavy rainfall, normal and log normal distribution are respectively the best fit. The results provide composite information for engineers and planners of drainage systems in the Himalayan foothill region of Western Uttar Pradesh.

### REFERENCE

Chow, V.T. 1964. *Handbook of applied hydrology*. New York: McGraw-Hill.



## GENERAL METHODOLOGY FOR THE CHARACTERIZATION OF RAINFALL TIME DISTRIBUTION

Van-Thanh-Van Nguyen, Assistant Professor  
Department of Applied Sciences  
University of Quebec  
Chicoutimi, Québec, CANADA

### INTRODUCTION

Information on variations in rainfall time characteristics is always necessary in various types of hydrologic studies concerning the planning, design and operation of water resources systems. Most previous research on the time distribution of rainfall usually involved the study of temporal distributions of "rainfall exteriors" characteristics, such as total event depth, total event duration and time between events, but very few studies deal with the time distribution of rainfall within each individual event or the temporal pattern of each event.

The objective of this study is to provide basic information on the variability of temporal patterns based on the probabilistic characteristics of an actual rainfall record. Information concerning the nature of the temporal distribution of rainfall within a rainfall event is usually presented as a mass curve of accumulated depth as a function of time. The purpose here is to ascertain the probability distributions of rainfall accumulated at the end of each time unit within such a total rainfall event representation.

First, a general theoretical model will be proposed, and then a numerical application will be presented by using a 32-year record of daily rainfall at Dorval Airport on Montreal Island (Canada). In the numerical example, the daily precipitation is selected because relatively long and reliable records are readily available and such data are frequently sufficient for many practical problems. The model, however, might be used for hourly rainfall (Nguyen and Rouselle 1981) and for rainfall durations of one day or longer.

### STOCHASTIC MODEL

In view of the objective stated in the previous section, a rainfall event in the present study is defined as an uninterrupted sequence of consecutive daily rainfall. With this definition of an event, the probabilistic characterization of a temporal rainfall pattern can be achieved by finding the probability distribution function of accumulated rainfall amounts at the end of each day within the total duration of rainfall event. Because the number of consecutive rainy days is random, the accumulated rainfall depth during any rainy period is the sum of a random number of random variables. Properties of such sums have been extensively treated by Todorovic (1970).

Consider an interval of time which consists of  $n$  days. Let  $M_n$  be defined as the number of consecutive rainy days starting from the first day of the  $n$ -day period. By this definition the random variable  $M_n$  can assume the values

0, 1, 2, ..., n. Let  $\varepsilon_\nu$  denote the daily rainfall depth in the  $\nu$ -th rainy day of the n-day period. The accumulated amount of rainfall  $S(n)$  during  $M_n$  consecutive rainy days of this n-day period can be defined as

$$S(n) = \sum_{\nu=0}^{M_n} \varepsilon_\nu . \quad (1)$$

Then the distribution function  $F_n(x)$  of  $S(n)$  can be written as follows (Nguyen and Rouselle 1981):

$$F_n(x) = P\{S(n) \leq x\} = \sum_{K=0}^n P\{X_K \leq x, M_n = K\} \quad (2)$$

in which  $P\{\cdot\}$  denotes the probability,  $X_0 = 0$  and  $X_K = \sum_{\nu=0}^K \varepsilon_\nu$  for  $K = 0, 1, 2, \dots, n$ .

In the above theoretical development, equation (2) was restricted to the daily rainfall process. However, it is readily seen that this restriction is not quite necessary. The general model, equation (2), might be used for rainfall data of any time interval or unit (hour, day, week, month, year). In the following, for daily rainfall process, we assume that

1. the daily rainfall depths  $\varepsilon_1, \varepsilon_2, \dots, \varepsilon_n$  are independent, identically distributed random variables with  $P\{\varepsilon_\nu \leq x\} = 1 - e^{-\lambda x}$  for every  $\nu = 1, 2, \dots, n$
2.  $\varepsilon_1, \varepsilon_2, \dots, \varepsilon_n$  are independent of  $M_n$  and
3. the sequences of rainy days can be represented by a first-order Markov chain.

Under these assumptions, we can write (Nguyen and Rouselle 1981):

$$F_n(x) = \sum_{K=0}^n \left( \frac{\lambda^K}{\Gamma(K)} \int_0^x u^{K-1} e^{-\lambda u} du \right) \cdot P\{M_n = K\} \quad (3)$$

where  $\Gamma(K) = (K-1)!$ .

#### NUMERICAL APPLICATION

The numerical application which follows is an illustrative example of the application of the theoretical model, equation (3) to an actual record of daily rainfall. Dorval Airport daily rainfall data for 1 to 31 July 1943-1974 will be used.

The general shape of frequencies of daily rainfall data as observed from Figure 1 suggests an approximate exponential distribution. The good agreement between fitted exponential distribution and observed frequency curves shown in Figure 1 supports the assumption (i) above. The probabilities  $P\{X_K \leq x\}$  for  $K = 1, 2, \dots, n$  can therefore be computed.

Many previous studies (Gabriel and Neumann 1962; Basu 1971) suggest that a first-order Markov chain might be successfully used to fit daily rainfall occurrence data. Figure 2 shows a good closeness between the Markov model and the observed frequencies. This supports assumption (3) above.

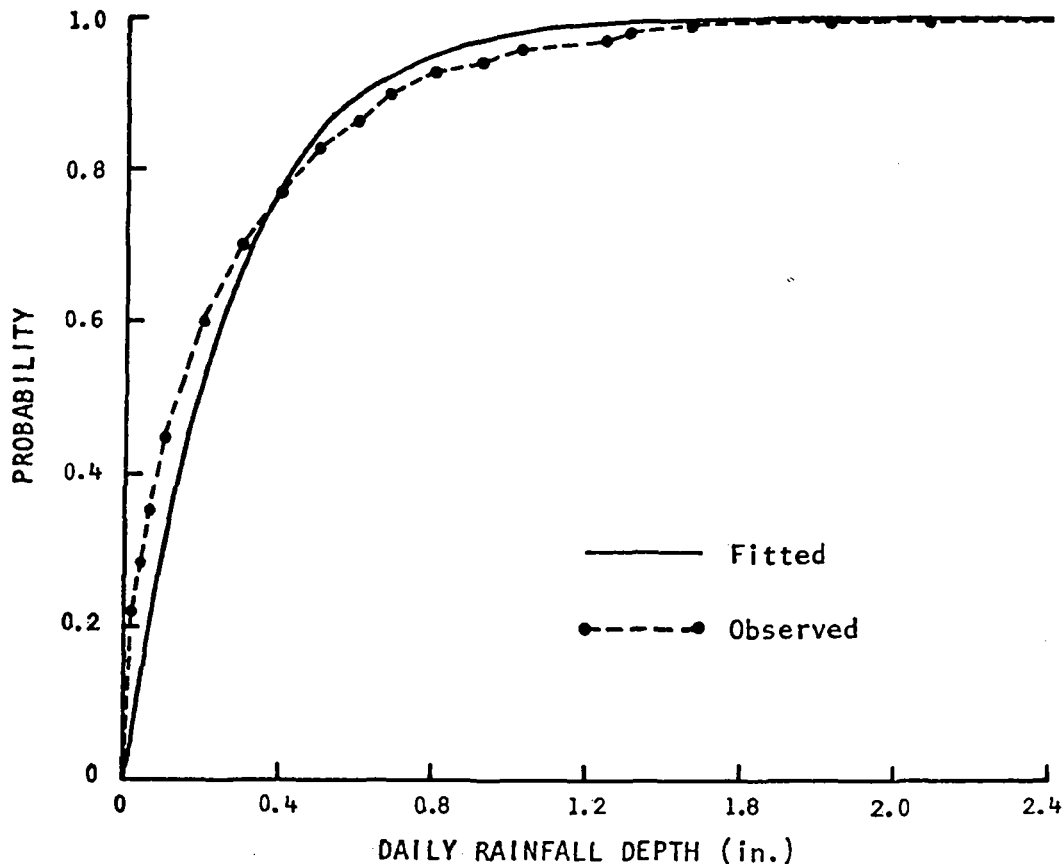

NOTE: in.  $\times$  25.4 = mm.

Figure 1. Observed and fitted exponential distributions of daily rainfall depths ( $\lambda = 3.7614$ )

After the probabilities  $P\{X_K \leq x\}$  and  $P\{M_n = K\}$  were estimated as described, the probability of accumulated rainfall amount during  $M_n$  consecutive rainy days in the  $n$ -day period can be obtained by using (3). The analysis of the 32-year daily rainfall record at Dorval Airport revealed that rarely is the length of the uninterrupted sequence of rainy days longer than 12 days. Therefore, a 12-day period was chosen as the maximum length of time period considered. That is,  $n$  must be less than or equal to 12 days. For purposes of illustration, the comparisons between observed and theoretical distributions shown in Figures 3 and 4 are only for  $n = 3$  and 7 days. It is seen that the theoretical distributions fit very well the observed frequency values.

#### CONCLUSION

A general theoretical methodology has been proposed that has a greater potential flexibility for characterizing the temporal pattern of rainfall than previously available. Using the methodology reported here, a temporal rainfall pattern can be characterized in terms of the total event duration, the total event depth, and the probability of accumulated rainfall at the end of each time unit within the event.

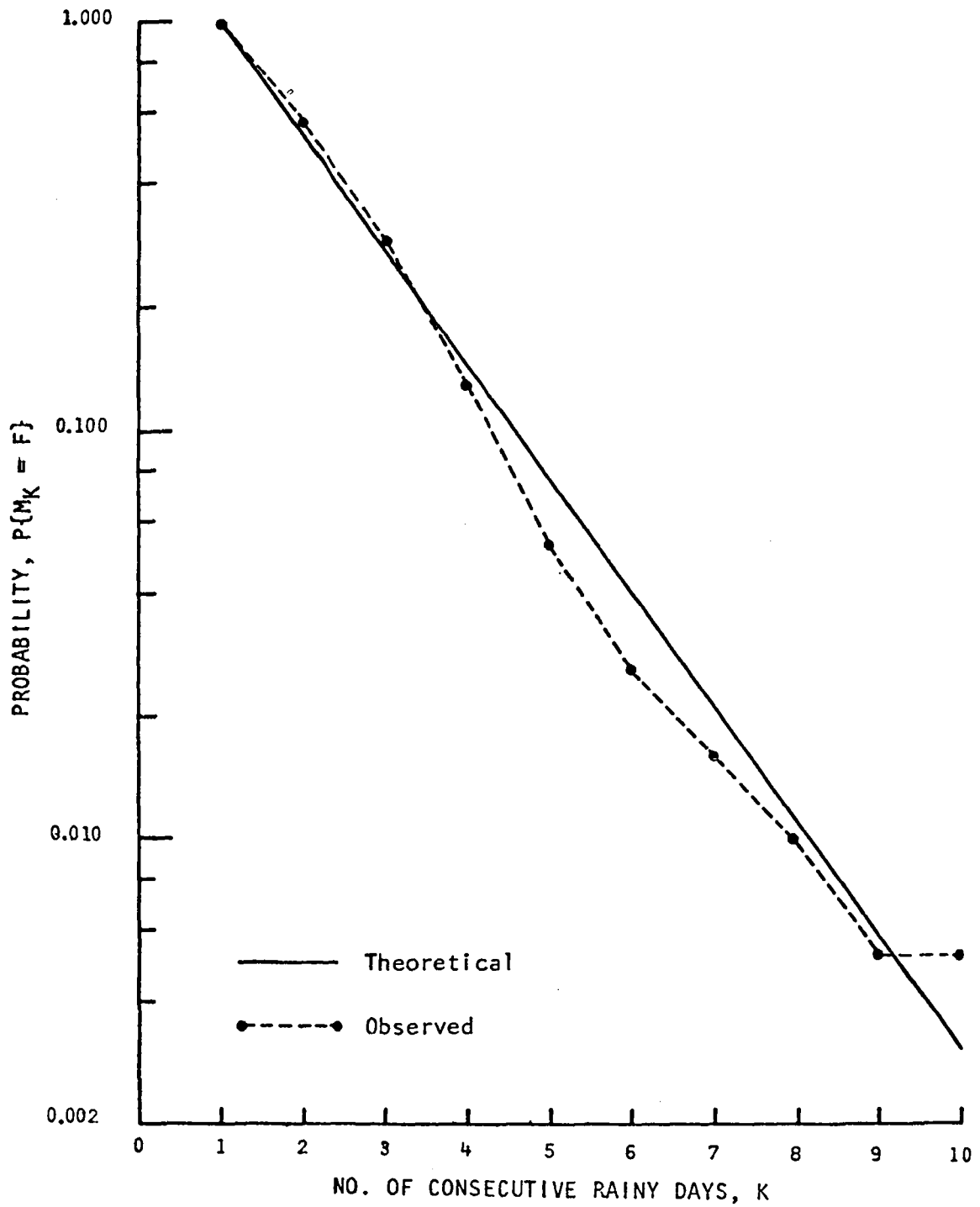

Figure 2. Theoretical probabilities and observed frequencies of K consecutive rainy days in the K-day period

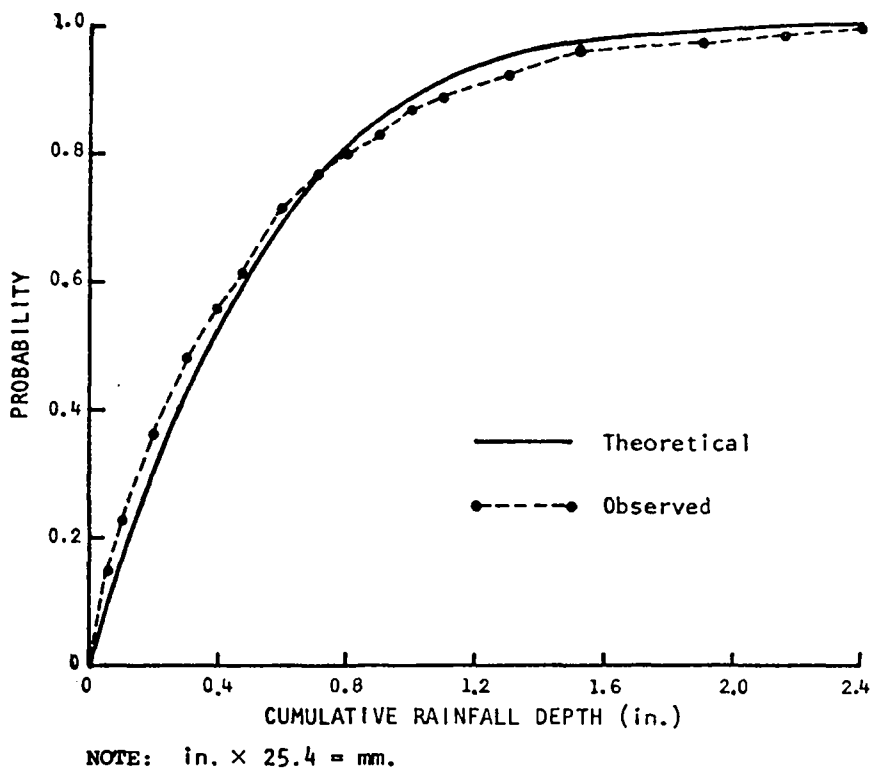

Figure 3. Comparison between observed and theoretical distributions of accumulated rainfalls in the 3-day period

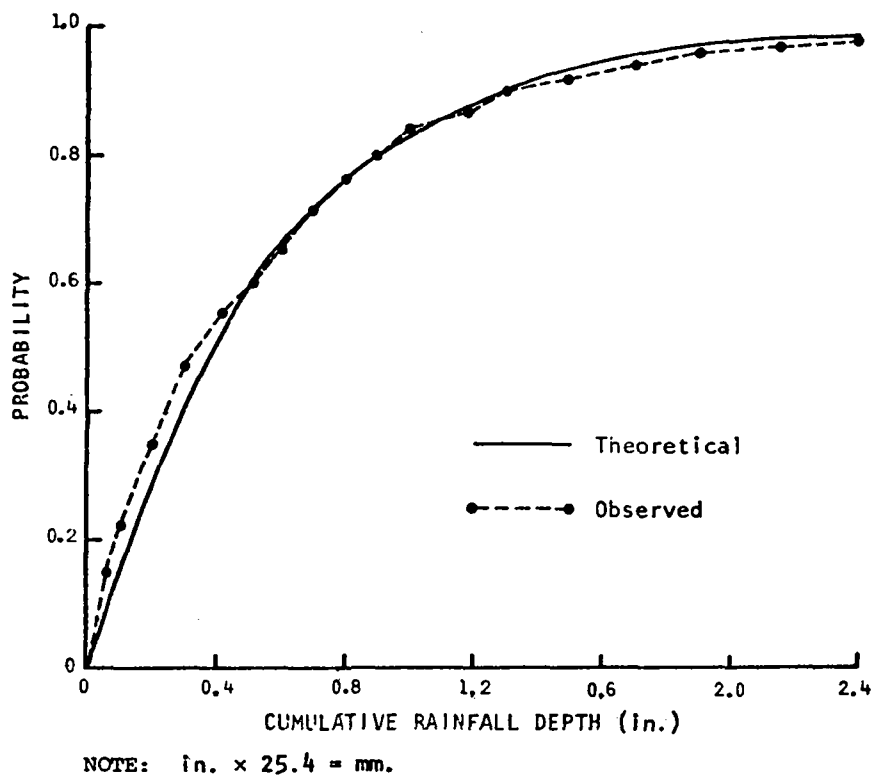

Figure 4. Comparison between observed and theoretical distributions of accumulated rainfalls in the 7-day period

REFERENCES

- Basu, A.N. 1971. Fitting of a Markov chain model for daily rainfall data at Calcutta. In Indian J. Meteorol. Geophys. 22:67-74.
- Gabriel, K.R., and Neumann, J. 1962. A Markov chain model for daily rainfall occurrence at Tel Aviv. Q.J.R. Meteorol. Soc. 88:90-95.
- Nguyen, V.T.V., and Rouselle, J. 1981. A stochastic model for the time distribution of hourly rainfall depth. Water Resour. Res. 17(2):399-409.
- Todorovic, P. 1970. On some problems involving random number of random variables. Ann. Math. Stat. 41(3):1059-1063.

## DETERMINISTIC AND PROBABILISTIC PROCESSES OF WEEKLY RAINFALL

Yu-Si Fok, Professor  
 Department of Civil Engineering  
 and Researcher  
 Water Resources Research Center  
 University of Hawaii at Manoa  
 Honolulu, Hawaii 96822, USA

Ronald H.L. Fong  
 Former Graduate Student  
 Department of Civil Engineering  
 University of Hawaii at Manoa  
 Honolulu, Hawaii 96822, USA

Edwin T. Murabayashi  
 Research Associate  
 Water Resources Research Center  
 University of Hawaii at Manoa  
 Honolulu, Hawaii 96822, USA

Andrew Lo, Doctoral Candidate  
 and Research Assistant  
 Department of Agronomy & Soil Science  
 University of Hawaii at Manoa  
 Honolulu, Hawaii 96822, USA

### INTRODUCTION

In the design of rain water catchment cistern systems, the following design variables are considered essential:

1. Input (weekly rainfall)
2. Catchment area (roof-top area)
3. Storage capacity (cistern volume)
4. Output (withdrawal/use).

Of these, the weekly rainfall is the only design variable that is uncontrollable and unpredictable. Thus, to design an adequate water catchment cistern system, the weekly rainfall must be estimated, using available statistical methods from existing rainfall records. In this paper, the deterministic and probabilistic processes of weekly rainfall data are discussed and presented for design purposes.

### SOLUTION METHODOLOGY

**DETERMINISTIC PROCESS OF WEEKLY RAINFALL.** In addressing the dependability problem of rain water cisterns, an analysis of the weekly or monthly rainfall data is necessary to establish the low rainfall frequencies. One method is the deterministic process of rainfall data analysis. To illustrate the methodology, low rainfall frequency curves developed for Pauoa Flats in Honolulu, Hawaii (Fig. 1) will be used.

From low rainfall frequency curves of the Pauoa Flats rain gage (Fig. 1), the magnitude of low rainfall for differing durations with a 20-yr recurrence period can be calculated and is shown below.

RAINFALL DISTRIBUTION			INCREMENTAL RAINFALL		
Dura- tion	Total Amount		Dura- tion	Amount/Week	
(wk)	(mm)	(in.)	(wk)	(mm)	(in.)
4	25.4	1.0	1	-----	-----
6	95.25	3.75	2	34.93	1.375
8	170.18	6.7	2	37.47	1.475
11	251.46	9.9	3	27.10	1.067
13	345.44	13.6	2	46.99	1.850

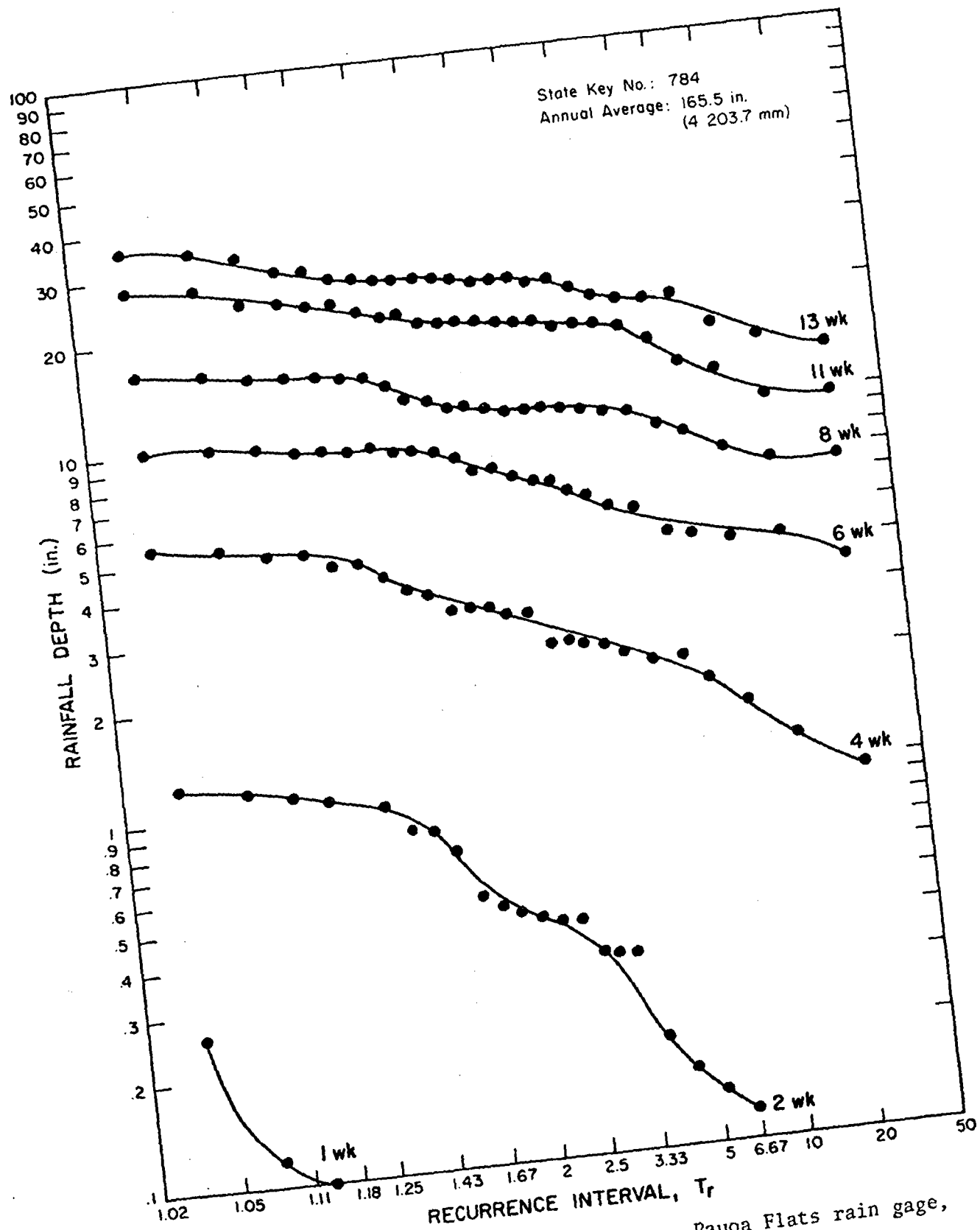

Figure 1. Low rainfall frequency curves, Pauoa Flats rain gage, Honolulu, Hawaii



Assuming that the low rainfall period covers the entire 13 weeks, the rainfall distribution during this 13-wk period can also be assumed to start from the lowest 4 wk, low-rainfall period of 25.4 mm (1 in.) which amounts to 6.35 mm (0.25 in.) per week. This uniform rainfall for 4 wk is shown in Figure 2. Next is the 6-wk period which has a total amount of 95.25 mm (3.75 in.). Since the former 4-wk rainfall of 25.4 mm has already been distributed, there is only 69.85 mm (2.75 in.) available for distribution in the remaining two weeks at 34.93 mm (1.375 in.) on each side. For the 8-wk period, the total rainfall is 170.18 mm (6.7 in.) of which 95.25 mm has been distributed; therefore, only 74.93 mm (2.95 in.) can be distributed at 37.47 mm (1.475 in.) per week on each side. Following this distribution process, the 11- and 13-wk rainfall periods have been respectively distributed as 27.18 mm (1.07 in.) and 46.99 mm (1.85 in.). All of these amounts are plotted in Figure 2 and shown in the last column of the Incremental Rainfall list on the preceding page.

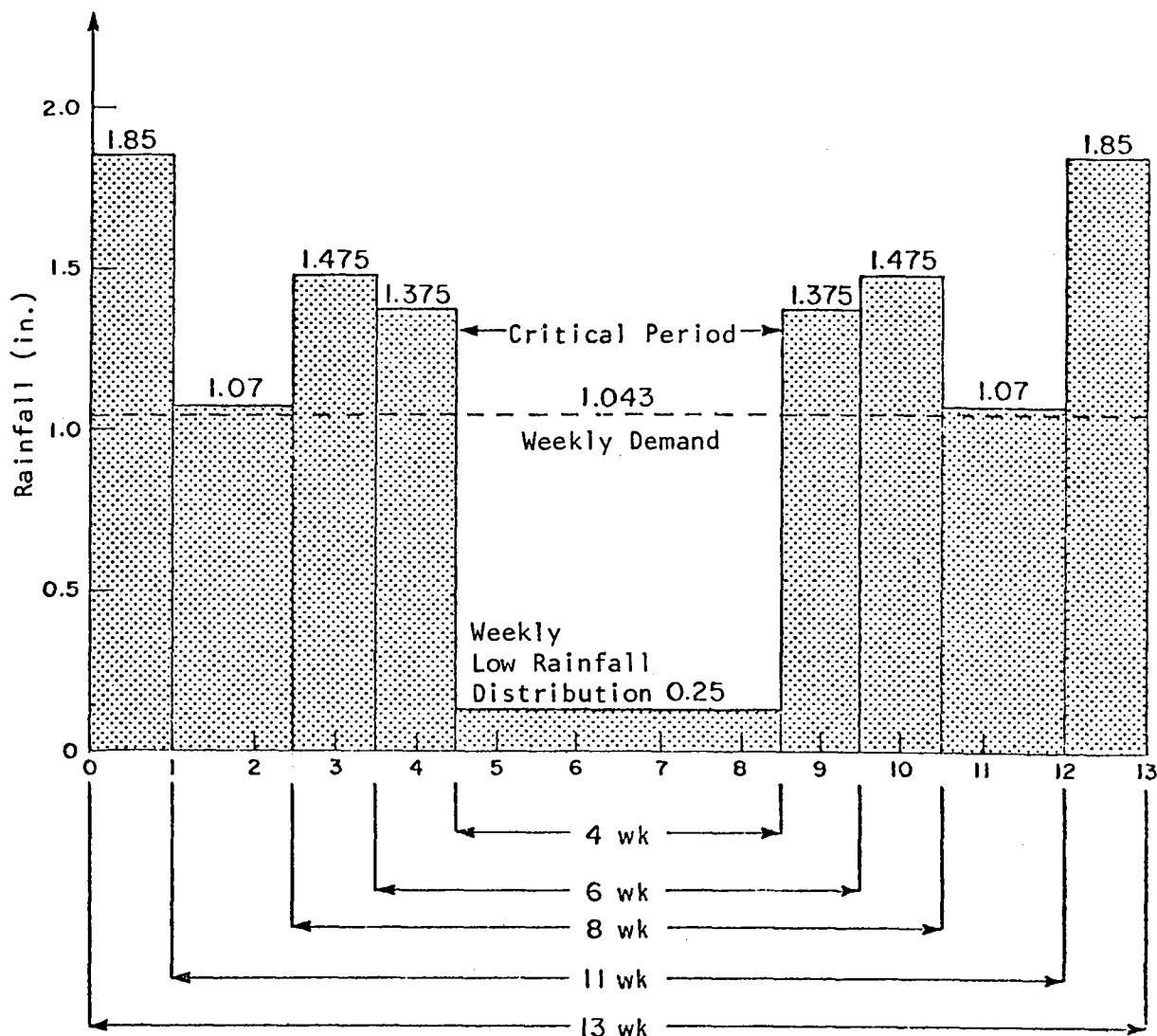

Figure 2. Determination of the critical period of low rainfall for storage capacity design in Pauoa Flats Area, O'ahu, Hawai'i

Before further analysis, the weekly rainfall demand should be determined. Let the average roof area of a residential house be  $200 \text{ m}^2$  ( $2150 \text{ ft}^2$ ). Then if the daily water demand is  $0.757 \text{ m}^3$  (200 gal), the required daily rainfall is  $3.785 \text{ mm}$  ( $0.149 \text{ in.}$ ). Converting this to a weekly requirement, the weekly rainfall demand is  $26.49 \text{ mm}$  ( $1.043 \text{ in.}$ ) and plotted as shown in Figure 2. The 4-wk, low-rainfall period can be recognized as the critical low-rainfall period because the weekly rainfall of  $6.35 \text{ mm}$  ( $0.25 \text{ in.}$ ) is much less than the weekly rainfall demand of  $26.49 \text{ mm}$  ( $1.043 \text{ in.}$ ). Other low-rainfall periods, such as 6-, 8-, 11-, and 13-wk, would provide weekly rainfall greater than the weekly water demand as shown in the last column of the Incremental Rainfall list on the preceding page. Since their values are greater than the weekly rainfall demand, for example,  $26.49 \text{ mm}$  ( $1.043 \text{ in.}$ ), they will not be considered as water-short periods with a 20 yr recurrence interval.

The risk analysis is presented below to illustrate the risk of  $25.4 \text{ mm}$  of rainfall not occurring during the 4-wk duration with a 20 yr recurrence interval.

$$\text{Risk} = 1 - \left(1 - \frac{1}{\text{Tr}}\right)^N \quad (1)$$

in which  $N$  is the period in years in which the low rainfall will occur at least once. Let  $N = 20$  years which is then substituted in equation (1) as

$$\begin{aligned} \therefore \text{Risk} &= 1 - \left(1 - \frac{1}{20}\right)^{20} \\ &= 1 - (0.95)^{20} \\ &= 1 - 0.3585 \\ \therefore \text{Risk} &= 0.64 . \end{aligned}$$

This means that there is a risk of approximately 6.4 out of 10 chances that the 20 yr, 4-wk low rainfall of the value at  $25.4 \text{ mm}$  may be reduced once in the next 20 years.

Figure 3 is an alignment chart developed to relate rainfall, catchment area, storage volume, daily water demand, and the available supply period for a rain catchment cistern system design. For example, when rainfall is  $25.4 \text{ mm}$  and the catchment area is  $200 \text{ m}^2$  ( $2150 \text{ ft}^2$ ), about  $5 \text{ m}^3$  of water will be produced. The line connecting the given rainfall depth and catchment area shows an intercept at  $5 \text{ m}^3$  on the storage volume scale. Similarly, when the given storage volume is  $41.5 \text{ m}^3$  and the daily water demand is  $0.77 \text{ m}^3$ , the intercept line connecting these two values is the 54th day on the supply period scale.

PROBABILISTIC PROCESS OF WEEKLY RAINFALL. Hays (1973) wrote of the Bayes theorem,

One can use not only the usual information derived from a sample but also any prior information he may have available. Such prior information may come from previous samples, from theoretical considerations, or simply from the experimenter's own opinions and beliefs about a particular state of affairs.

The Bayesian approach is first concerned with a set of beliefs or opinions which are expressed in probability terms. However, such probabilities may change as a result of new information, such as, a set of weekly rainfall data that can provide prior information.

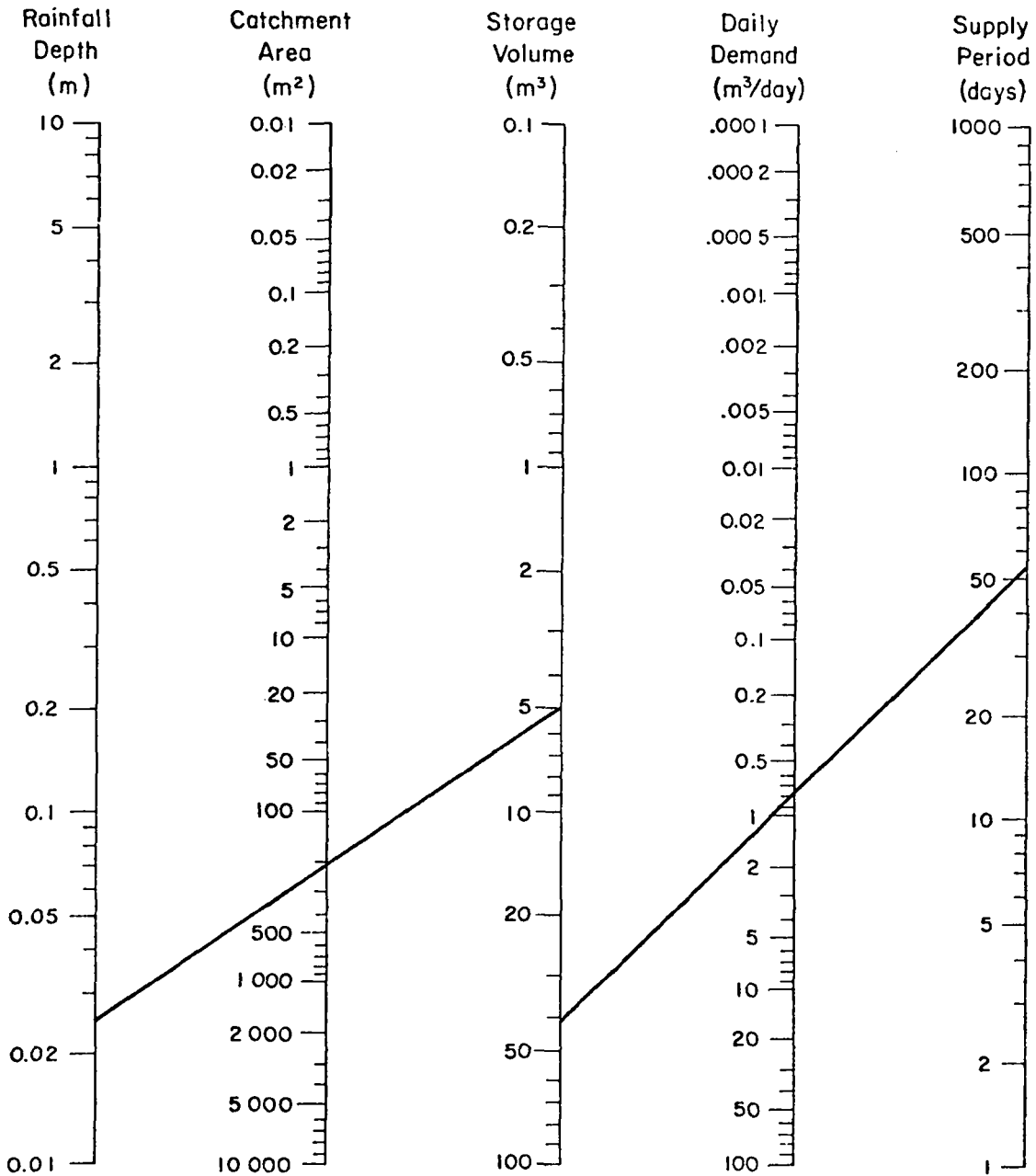

Figure 3. Alignment chart showing relation between rainfall catchment area, storage volume, daily water demand, and available supply period for a rain-catchment system design and management

The mathematical expression of the Bayes theorem can be written as

$$p (B_j A_k) = \frac{P (A_k/B_j) p (B_j)}{\sum_{i=1}^J P (A_k/B_i) p (B_i)} \quad (2)$$

and

$$1, 2, \dots, i, j, \dots, J; 1, 2, \dots, k, \dots, K,$$

where

$$p(B_j) = \text{prior probabilities}$$

$$p(A_j/B_j) = \text{likelihood probabilities}$$

$$p(B_j/A_k) = \text{posterior probabilities.}$$

In applying the Bayes theorem, Phillips (1973) devised the following eight-step process for calculating the posterior probabilities:

- Step 1 Specify beliefs or opinions
- Step 2 Assess the prior probabilities
- Step 3 Check the sum of the prior probabilities to insure they equal one
- Step 4 Determine the likelihood probabilities
- Step 5 Multiply each prior probability by each corresponding likelihood probability
- Step 6 Find the sum of the product in Step 5
- Step 7 Divide each product of Step 5 by the sum of Step 6
- Step 8 Check the sum of Step 7 which should equal one.

To illustrate the Bayesian approach for forecasting hydrologic events, an example is given following the eight-step Phillips (1973) process.

Assume that on any given day the prior estimate of the weather at a given location is 0.3 that it will rain and 0.7 that it will not rain. Now suppose that the weather forecaster has predicted rain and that when he does predict rain his prediction has been correct 75% of the time. The posterior probabilities can be determined by utilizing the eight-step procedure:

<u>Step 1</u>	<u>Step 2</u>	<u>Step 4</u>	<u>Step 5</u>	<u>Step 7</u>
$P$ rain	0.3	0.75	0.225	(rain) $\frac{0.225}{0.400} = 0.5625$
$P$ no rain	0.7	0.25	0.175	$P(\text{no rain}) \frac{0.175}{0.400} = 0.4375$
<u>Step 3</u>	1.0	<u>Step 6</u>	0.400	<u>Step 8</u> sum = 1.0000

The probability that it will rain has now been revised to 56.25% rather than 30%, based on additional information incorporated into the Bayes theorem by the likelihood probability. The decision maker must consider these revised probabilities for each event or opinion before selecting the best alternative. The credibility of the likelihood probability should also be evaluated.

As shown in the Bayesian approach, the prior probabilities of rain for a given place can be revised by the likelihood probability based on a forecaster's established success in prediction. The same application can be used to obtain the weekly rainfall probability for rain water cistern systems. Rainfall records of the Pauoa Flats rain gage (1952-1976) on O'ahu were used to obtain the prior probabilities by the following steps:

- Step 1 Group the weekly rainfall records into one set of data. For example, all first week records for each year will be grouped together into a total of 52 sets of data representing the 52 weeks in the year, and each set having a total of 25 events representing 25 years of records. Each set of data will then be separated into seven classes based on the amount of rainfall in each week, such as

<u>Class</u>	<u>Range (in.)</u>	<u>Class</u>	<u>Range (in.)</u>
1	0.00 to 0.99	5	4.00 to 4.99
2	1.00 to 1.99	6	5.00 to 5.99
3	2.00 to 2.99	7	6.00 and above
4	3.00 to 3.99		

Step 2 Tabulate the number of rainfall occurrences within the parameters of each class. As a check, the total for each class should be 25.

Step 3 Divide the number of occurrences for each class by 25 to obtain the prior probability for that class and set of data. The total sum of prior probabilities for each set of data should equal 1.00.

To illustrate the use of obtaining the prior probabilities,  $P(B_j)$ , from the data for Pauoa Flats, the prior probabilities for the first week are shown below.

<u>Year</u>	<u>1st Wk Data (in.)</u>	<u>Year</u>	<u>1st Wk Data (in.)</u>	<u>Year</u>	<u>1st Wk Data (in.)</u>
1952	1.50	1960	3.02	1968	11.18
1953	1.76	1961	0.60	1969	6.38
1954	2.58	1962	1.82	1970	0.70
1955	5.23	1963	2.14	1971	0.96
1956	2.08	1964	0.16	1972	4.82
1957	0.10	1965	4.24	1973	0.14
1958	2.08	1966	3.30	1974	1.72
1959	4.20	1967	0.94	1975	0.19

The number of occurrences for each class is computed from the above data and is shown below.

<u>Class No.</u>	<u>Class (in.)</u>	<u>Occurrence</u>
1	0 to 0.99	8
2	1 to 1.99	4
3	2 to 2.99	4
4	3 to 3.99	2
5	4 to 4.99	4
6	5 to 5.99	1
7	6 and above	2
	<b>Total</b>	<b>25</b>

The prior probability  $P(B_j)$  for each class can now be calculated.

0 to 0.99	$8/25 = 0.32$
1 to 1.99	$4/25 = 0.16$
2 to 2.99	$4/25 = 0.16$
3 to 3.99	$2/25 = 0.08$
4 to 4.99	$4/25 = 0.16$
5 to 5.99	$1/25 = 0.04$
6 & above	$2/25 = 0.08$
	<b>Total = 1.00</b>

The likelihood probability  $P(A_j/B_j)$  is computed in a similar manner to the prior probabilities. An example using 1966 data showing the number of occurrences for each class is shown below.

<u>Rainfall (in.)</u>	<u>Occurrence</u>
0 to 0.99	15
1 to 1.99	10
2 to 2.99	10
3 to 3.99	6
4 to 4.99	4
5 to 5.99	3
6 & above	4
Total	52

The likelihood probability is then computed.

<u>Rainfall (in.)</u>		<u>Likelihood Probability</u>
0 to 0.99	15/52	0.288462
1 to 1.99	10/52	0.192308
2 to 2.99	10/52	0.192308
3 to 3.99	6/52	0.115385
4 to 4.99	4/52	0.076923
5 to 5.99	3/52	0.057692
6 & above	4/52	0.076923

After the prior probabilities and likelihood functions have been obtained, Bayes theorem as shown in equation (2) can be utilized to determine the posterior probabilities:

$$\therefore P(A_1/B) = \frac{(0.32)(0.288462) + (0.32)(0.288462) + (0.16)(0.192302) + (0.16)(0.192302) + (0.08)(0.115385) + (0.16)(0.076923) + (0.04)(0.057692) + (0.08)(0.076923)}{(0.08)(0.076923)}$$

$$\therefore P(A_1/B) = \frac{0.09321}{0.092308 + 0.030768 + 0.030768 + 0.009321 + 0.012308 + 0.002308 + 0.006154}$$

$$\therefore P(A_1/B) = \frac{0.092308}{0.183845} = 0.502097$$

Similarly,

$$P(A_2/B) = \frac{(0.16)(0.192303)}{0.183845} = 0.167360 \quad P(A_5/B) = \frac{(0.16)(0.076923)}{0.183845} = 0.066946$$

$$P(A_3/B) = \frac{(0.16)(0.192302)}{0.183845} = 0.167260 \quad P(A_6/B) = \frac{(0.04)(0.057692)}{0.183845} = 0.012552$$

$$P(A_4/B) = \frac{(0.08)(0.115385)}{0.183845} = 0.050210 \quad P(A_7/B) = \frac{(0.08)(0.076923)}{0.183845} = 0.033473$$

A computer was used to obtain the posterior probabilities for each of the 52 weeks.

The above Bayesian analysis does not utilize the sequential characteristics of the weekly rainfall data because it uses only the lowest year's weekly rainfall record to obtain the likelihood probability function. To improve on this shortcoming, the Markov process should be utilized for the sequential simulation of data. However, this Bayesian analysis does show how to estimate

the weekly rainfall using the probabilistic process.

### CONCLUSIONS

The important design variables of a roof catchment-cistern system have been identified as (1) weekly rainfall (input), (2) catchment area (roof), (3) storage (water tank), and (4) water consumption rate (output). Of these four variables, the weekly rainfall (input) is the only one that is uncontrollable. Weekly rainfall can be estimated starting with the low rainfall frequency curves, and the deterministic potential low rainfall for a given duration has been shown. Since the catchment area is predetermined, the storage capacity requirement can be estimated for the critical period of low rainfall. Using the alignment chart, the length of supply period can be determined from a given storage when the daily or weekly water demand is known. The methodology of the Bayes theorem for the probabilistic process of weekly rainfall data has been explained in length to enable users of this method to analyze rainfall data.

### REFERENCES

- Fok, Y.S.; Fong, R.H.L.; Hung, J.; Murabayashi, E.T.; and Lo, A. 1980. *Bayes-Markov analysis for rain-catchment cisterns*. Tech. Rep. No. 133, Water Resources Research Center, University of Hawaii, Honolulu. viii + 100 p.
- Fong, R.H.L. 1979. "The Bayesian approach to stochastic hydrology of a roof cistern water supply system at Tantalus, Oahu." Master's thesis, University of Hawaii at Manoa, Honolulu. 166 p.
- Hays, W.L. 1973. *Statistics for social science*. New York: Holt, Rinehart, and Winston. 809 p.
- Middleton, J.H. 1892. *The remains of ancient Rome*. Vol. 1. London: A & C Black.
- Phillips, L.D. 1973. *Bayesian statistics for social science*. Middlesex, England: Nelson & Sons. 60 p.
- Viessman, W., Jr.; Harbaugh, T.E.; and Knapp, J.W. 1972. *Introduction to hydrology*. New York: Intext Education.
- Wentworth, C.K. 1959. *Rainfall, tanks, catchment, and family use of water*. Rep. R13, Hawaii Water Authority, Honolulu, Hawaii.
- Zellner, A. 1971. An introduction to Bayesian inference. In *Econometrics*, p. 18. New York: John Wiley.

## COMPUTERIZED METHODS IN OPTIMIZING RAINWATER CATCHMENT SYSTEMS

Eric J. Schiller, Associate Professor

and

Brian Latham, Graduate Student  
Civil Engineering Department  
University of Ottawa  
Ottawa, Ontario, CANADA K1N 9B4

### USE OF RAINWATER COLLECTION SYSTEMS IN CANADA

Rainwater collection systems (RWCS) have been widely used in Canada from the time of the early settlers. The tradition was brought from Europe and fitted well with the needs here. In the older farm areas, such as that around Ottawa, a cistern was a common part of a farmhouse as it provided soft water for washing and bathing—a necessity with natural soaps. Drinking water was obtained from a well or spring, if available, because of the mineral content which "quenched" thirst.

Presently, RWCS's are still in use on farms in Ontario and on the prairies of the west where groundwater may be saline and farmhouses are separated by great distances. In many coastal areas, such as the Atlantic area of Nova Scotia, the terrain is rocky with little or no soil cover. A central water system is difficult and prohibitively expensive to install. However, coastal areas have high, consistent rainfall and moderate temperatures which make a RWCS an attractive drinking water source.

Another area for use of RWCS's that may show great promise in the future is the northern regions of Canada. During the warm season, RWCS's could provide safer drinking water. Fully reliable, year-round systems would not be practical because of the long freeze up during the winter period.

In all of these remote areas, a RWCS represents a least-cost option because of the isolation of individual users, the unsuitable quality of groundwater or the sheer unavailability of fresh water. Estimates of costs for setting up a system will depend on many factors, but are reduced because of the nature of Canadian houses. Much of what is required is already constructed in the house and cannot be charged exclusively to the RWCS. Roofs are generally large and pitched (to carry away the rain and snow). A sealed basement with poured concrete floor and walls and plumbing is standard. Hence, one and possibly two walls are available for use in tank construction. In areas without a central water system, a pump and pressure tank are standard equipment and are not an additional cost due to the RWCS.

**SNOW AND COLD WEATHER.** Snow is a significant form of precipitation in Canada. Precisely how its contribution in rainwater storage models should be calculated is a subject for future study. Its effect is determined by a host of factors, such as depth and type of snow, roof construction, and wind patterns. In particular, temperatures prior to snowfall will be significant as gutters and downpipes can be frozen solid with ice although the snow is melting.



For this study, only rainfall data will be considered. Neglecting snow completely is a first approximation and it is assumed that snow either blows off or is not collected due to a frozen collection apparatus.

In the fall, more water may be collected from snowmelt than in the spring as antecedent temperatures are higher and the collection apparatus is open. In any case, the effect of neglecting snow is to underestimate inflow into the storage reservoir.

CANADIAN DATA USED. With these possible areas of use and different rainfall patterns in mind, data were examined for Ecum Secum, Nova Scotia (an Atlantic seacoast area with moderate climate), Ottawa (Lemieux Island), and Fort Smith, North West Territories (characterized by low precipitation and extreme temperatures). Some characteristics of the historic data are given in Table 1.

TABLE 1. SUMMARY OF RAINFALL CHARACTERISTICS

	Ecum Secum N.S.	Ottawa (Lemieux)	Fort Smith NWT
Length of Record (mo.)	180	180	180
Mean Annual Rainfall (mm)	1255.9	655.1	231.1
Annual Coefficient of Variation	0.1809	0.1484	0.3258
Monthly Coefficient of Variation	0.5320	0.6855	1.4208
Minimum Annual Rainfall (mm)	894.9	527.8	92.7
Min./Mean Annual	0.713	0.806	0.401
Mean Monthly Rainfall (mm) (Std. Dev.)			
January.....	80.9 (49.1)	12.6 (14.0)	0.0 ( 0.0)
February.....	54.5 (33.1)	14.0 (15.2)	0.0 ( 0.0)
March.....	84.3 (38.4)	30.3 (27.2)	0.3 ( 1.2)
April.....	89.4 (44.5)	54.9 (22.2)	3.2 ( 3.9)
May.....	130.5 (48.4)	63.0 (26.0)	25.9 (15.5)
June.....	112.1 (42.2)	79.7 (41.7)	45.7 (30.8)
July.....	103.1 (54.4)	94.4 (30.8)	56.7 (34.3)
August.....	108.4 (82.2)	86.1 (36.0)	48.7 (28.8)
September.....	99.0 (36.8)	72.0 (22.9)	41.2 (15.6)
October.....	137.1 (42.4)	56.9 (27.7)	9.3 ( 7.2)
November.....	142.6 (66.8)	64.1 (31.3)	0.3 ( 0.7)
December.....	114.0 (60.4)	27.0 (16.6)	0.0 ( 0.1)

#### METHODS TO BE EXAMINED

The methods of sizing the reservoir considered herein are (1) the mass curve based on historic data (Grover 1971); (2) the yield after storage (YAS) model (Jenkins et al. 1978); (3) Rationing and Stocking Model (Perrens 1975); and (4) statistical method (Ree et al. 1971). All are modifications of the mass curve method developed by Rippl (1883).

MASS CURVE. In this method, a variable rainfall inflow is subtracted from a constant demand outflow. The maximum cumulative difference is the required storage for 100% reliability.

This can be expressed as follows. In a data record of length N, given that cumulative demand equals cumulative supply (i.e., storage = 0) in the jth month of record, for  $j = 1, \dots, N$ , and for  $k > j$ , then the storage required at month k is

$$s_{j,k} = \sum_{i=j+1}^k (d_i - AR_i)$$

where

$d_i$  = the demand for month i

A = roof area

$R_i$  = rainfall in month i .

The minimum storage required to meet the demand is

$$S = \text{MAX}_{\substack{j=1, N \\ k=j+1, N}} (s_{j,k})$$

Demand and rainfall inflow are simultaneously accumulated to determine the following month's initial storage. The computation procedure is schematically shown in Figure 1.

YIELD AFTER STORAGE (YAS). Jenkins et al. (1978) used monthly rainfall in California. They modified the mass curve model by assuming that the maximum demand for each month is limited to the initial quantity in storage. It is withdrawn after rainfall has been added and spillage determined. This calculation is illustrated in Figure 2. A plot of yearly demand, D, over mean annual inflow ( $\bar{A}\bar{R}$ , roof area times mean annual rainfall) against storage capacity, S, over mean annual inflow was made for various levels of performance, calculated on a volume basis. For each demand and roof area combination,  $D/\bar{A}\bar{R}$  was calculated and  $S/\bar{A}\bar{R}$  read off the desired performance curve. This was then converted to a volume.

For 100% reliability,  $S_{i-1} > d_i$ , where  $S_{i-1}$  is the storage at the end of the (i-1)th month. Also it can be seen that the tank can never be full at the beginning of the month.

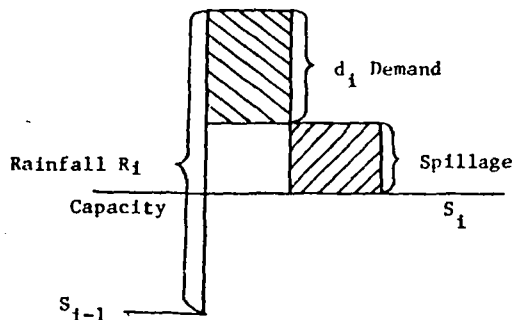

Figure 1. Mass curve calculation

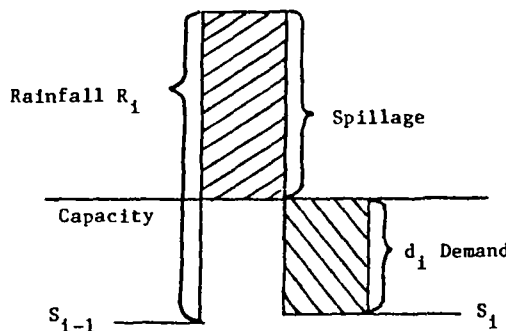

Figure 2. Yield after storage calculation

**RATIONING AND STOCKING.** This is a mass-curve technique using historic data. Inflow to and outflow from the reservoir are calculated simultaneously. Spills and end-of-month storage are determined after demand has been met. Two important additional elements, rationing and external source of supply, are introduced in this model.

**Rationing.** If the amount in storage at the beginning of the month is less than the monthly demand, demand is reduced (in this case to 75% of its normal level).

**External Stocking.** Water is assumed to be available in standard lots of 5 m<sup>3</sup>. Initially, 5 m<sup>3</sup> is placed in the tank. If the amount in storage at the beginning of a month is less than the demand for the month, lots of 5 m<sup>3</sup> are brought in until the demand can be met or the tank overflows.

Performance is based on a failure rate, defined as the number of times water has to be imported. It is a volume-rated time performance level. For each roof area and each demand level, failure rate per year is plotted against storage. A desired level is chosen and the required storage for a given area and demand is read off the graph.

**STATISTICAL METHOD.** Here the performance level is determined as the frequency of occurrence of rainfall intensities of a given probability. From historic monthly data, monthly rainfall intensities were calculated for a series of periods from 2 to 84 months.

Having selected a level of performance for the system, for each period the intensities for all periods of this length in the data were calculated and ranked and probabilities calculated. A value with a probability corresponding to that performance was chosen. Cumulative rainfalls for each period were determined and a mass curve technique applied to the resulting series of cumulative rainfalls.

#### CALCULATION PARAMETERS

Historic data were used with fifteen years of monthly rainfall data: 1966 to 1980, for Ecum Secum; 1961-1975, for Ottawa (Lemieux); and 1966-1980 for Fort Smith. No allowance was made for runoff losses or roofwash except in the Rationing and Stocking Model where 2 mm/mo was subtracted from rainfall.

For all but the Fort Smith data, a performance level of 98.3% (one failure in 5 years, 0.2 failures per year) was applied. For Fort Smith, demand was assumed to be for 6 months from May to October and maximum possible performance was thus only 50%. A special mass curve calculation was made to take into consideration non-continuous demand and a failure level of 6 per year was chosen for the Rationing and Stocking Model.

Programmes were run for demands of 100, 200, 300, 400, 500, 600, 700 l/day; rooftop areas of 50, 100, 150, 200, 250, 300, 350, 400 m<sup>2</sup> and storage capacities of 10, 30, 50, 70, 90, 110, 130, 150 m<sup>3</sup>. Those combinations giving yearly demands less than or equal to the mean annual inflow were tabulated.

The demand/storage/performance curves as determined by the yield after storage method are presented in Figure 3 and summaries of the results of the various methods for the same data are given in Tables 2, 3, and 4.

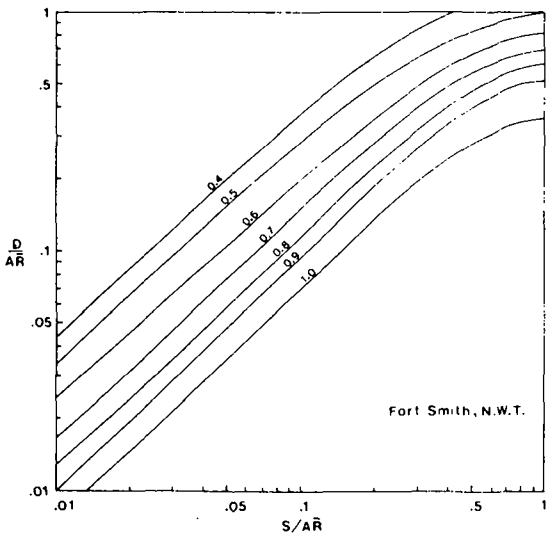
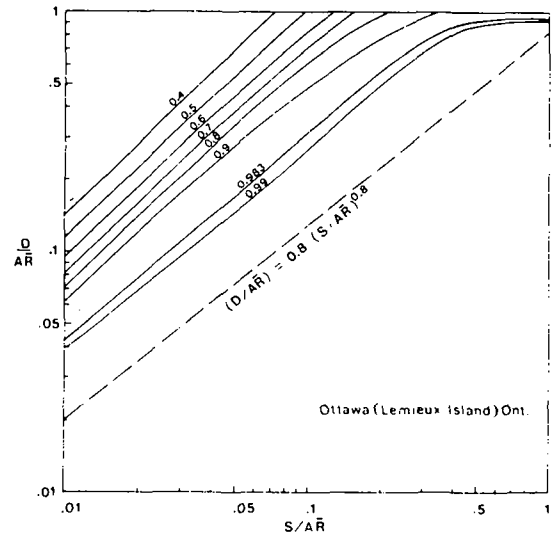
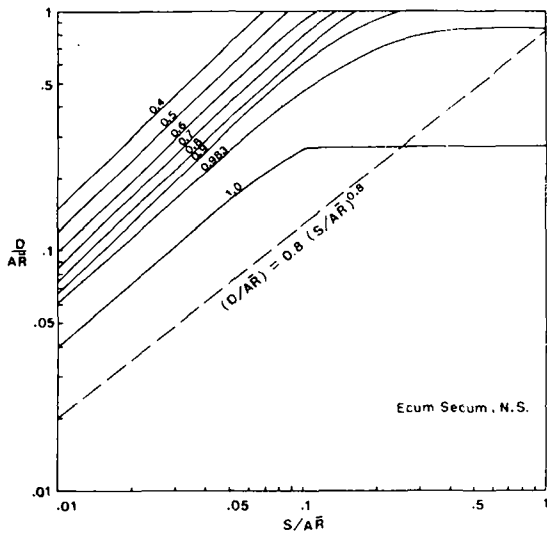

- D - yearly demand
- A - roof catchment area
- $\bar{R}$  - mean annual rainfall
- S - storage tank capacity

Figure 3. Demand/storage/performance curves for YAS model

TABLE 2. COMPARISON OF CALCULATED STORAGE LEVELS, FORT SMITH, NWT

ROOR AREA (m <sup>2</sup> )	DEMAND		STORAGE (m <sup>3</sup> )			
	(ℓ/day)	(D/AR)	Mass Curve	Stock-Ration (6 failures/yr)	YAS (50%)	Stat'l (50%)
100	100	.79	9.3	3	10.0	80.7
150	100	.53	4.6	4	7.5	9.6
200	100	.40	3.1	4	6.7	2.8
	200	.79	18.6	7	20.1	161.4
250	100	.32	3.1	4	6.1	2.0
	200	.63	14.0	7	16.7	75.2
	300	.95	32.6	-	41.0	329.6
300	100	.26	3.1	4	6.1	1.2
	200	.53	9.3	7	15.1	19.3
	300	.79	27.9	44	30.1	242.1
350	100	.23	3.1	4	5.9	0.3
	200	.45	6.2	7	14.3	6.4
	300	.68	23.3	27	25.4	154.6
	400	.90	41.9	--	47.3	410.3
400	100	.20	3.1	6	6.1	0.0
	200	.40	6.2	8	13.4	5.6
	300	.59	18.7	25	24.9	76.6
	400	.79	37.3	--	40.2	322.8
	500	.99	55.9	--	83.2	578.5

TABLE 3. COMPARISON OF CALCULATED STORAGE LEVELS, ECUM SECUM, N.S.

ROOF AREA (m <sup>2</sup> )	DEMAND (ℓ/day)	DEMAND (D/AR)	STORAGE (m <sup>3</sup> )			
			Mass Curve	Stock-Ration (0.2 failures /yr)	YAS (98.3%)	Stat'l (98.3%)
50	100	.58	7.5	-	9.1	3.5
100	100	.29	5.6	-	6.9	0.8
	200	.58	15.1	6	18.2	7.0
	300	.87	31.9	19	----	25.0
150	100	.19	5.4	-	6.4	0.0
	200	.39	11.6	6	15.0	4.2
	300	.58	22.7	14	27.3	10.6
	400	.78	36.8	22	48.9	28.4
	500	.97	72.2	--	----	59.7
200	100	.15	5.1	-	6.2	0.0
	200	.29	11.3	6	13.8	1.6
	300	.44	18.1	8	22.6	7.7
	400	.58	30.2	15	36.4	14.1
	500	.73	44.1	30	56.5	31.8
	600	.87	63.9	50	----	50.0
250	100	.12	4.9	-	5.5	0.0
	200	.23	11.1	-	12.8	0.0
	300	.35	17.3	8	21.6	5.1
	400	.47	25.7	10	32.3	11.2
	500	.58	37.8	18	45.5	17.6
	600	.70	51.3	38	63.7	35.2
	700	.81	66.4	70	95.7	53.4
300	100	.10	4.6	-	7.8	0.0
	200	.19	10.8	-	16.0	0.0
	300	.29	17.0	8	26.0	2.4
	400	.39	23.2	8	37.8	8.5
	500	.49	33.3	17	52.0	14.6
	600	.58	45.4	30	68.6	21.2
	700	.68	58.6	50	89.9	38.6
350	100	.08	4.4	-	6.1	0.0
	200	.19	10.6	-	12.5	0.0
	300	.25	16.8	6	18.4	0.0
	400	.33	23.0	8	28.1	5.9
	500	.42	29.2	13	38.6	12.0
	600	.50	40.8	23	50.5	18.1
	700	.58	52.9	36	63.7	24.7
400	100	.07	4.1	-	6.0	0.0
	200	.15	10.3	-	12.4	0.0
	300	.22	16.5	4	18.0	0.0
	400	.29	22.7	7	27.6	3.3
	500	.36	28.9	14	36.4	9.4
	600	.44	36.3	24	45.2	15.5
	700	.51	48.4	38	58.7	21.5

TABLE 4. COMPARISON OF CALCULATED STORAGE LEVELS, OTTAWA (LEMIEUX)

ROOF AREA (m <sup>2</sup> )	DEMAND (ℓ/day) (D/AR̄)		STORAGE (m <sup>3</sup> )					
			Mass Curve	Stock-Ration NR*	R†	YAS (98.3%)	Statistical (98.3%)	(min)
100	100	.56	11.1	6	6	12.9	7.3	11.2
150	100	.37	10.6	6	6	12.2	5.4	10.7
	200	.74	23.6	22	18	28.5	17.0	23.7
200	100	.28	10.2	6	6	12.3	5.2	10.3
	200	.56	22.3	18	17	25.9	14.6	22.4
	300	.84	37.5	38	30	48.4	27.5	37.7
250	100	.22	9.7	6	6	11.1	5.0	9.8
	200	.45	21.8	18	12	24.5	12.2	22.0
	300	.67	33.9	35	27	42.5	24.4	34.1
	400	.89	58.2	--	57	68.8	43.0	58.6
300	100	.19	9.2	6	6	10.8	4.8	9.3
	200	.37	21.3	15	15	24.5	10.9	21.5
	300	.56	33.4	30	25	38.9	21.9	33.7
	400	.74	47.2	70	40	57.0	34.1	47.5
	500	.93	86.1	--	90	----	71.4	82.6
350	100	.16	8.8	6	--	10.5	4.6	8.8
	200	.32	20.9	17	15	23.8	10.7	21.0
	300	.48	33.0	27	27	36.6	19.5	33.2
	400	.64	45.1	40	35	53.0	31.7	45.4
	500	.80	61.2	--	61	77.9	43.9	61.5
	600	.96	124.0	--	--	----	106.8	117.7
400	100	.14	8.3	6	--	10.4	4.4	8.4
	200	.28	20.4	14	13	24.6	10.5	20.5
	300	.42	32.5	26	25	36.6	17.1	32.7
	400	.56	44.6	42	36	51.8	29.2	44.9
	500	.70	56.9	--	57	70.7	41.4	57.2
	600	.84	75.1	--	75	96.9	55.1	75.5
	700	.98	176.4	--	--	----	145.5	153.4

\*No ration.

†Ration.

## DISCUSSION

It is obvious from the length of the tables that a great number of possible combinations of demand and area exist. The largest values for storage size were given by the yield after storage model. This emphasizes the conservative nature of this model. The demand/storage/performance plot developed by Jenkins et al. (1978) gives the most concise and general display of information of the methods studied.

Despite its more complex statistical nature and calculations, the statistical method did not give extremely high values for storage required. Intuitively, one feels that it is a method of combining the worst rainfalls of the period to give the 'worst of the worst'. Rather, compared to the YAS and mass curve, its values were low. This is because the historical minimum values of accumulated rainfall for a given period are not used but larger values with longer return periods. Even if minimum values were used regardless of their probability, the storage needed would be equivalent to that of the mass curve method. This is expected because the maximum storage value in the mass curve method occurs in some particular sequence of months. The accumulated rainfall for the period of this sequence is the minimum for all values of this period length. Hence, its value will appear in the statistical series and once again produce the maximum storage value. Thus, for set probability levels, the storage will be less as larger accumulated rainfall values are used in the series.

To illustrate the above points, the programme for the statistical method was rerun for Ottawa (Lemieux) using the minimum values for each time period. The resulting volumes are nearly identical to the mass curve method.

The statistical method gave erratic results when used at the 50% level in the Fort Smith case. Modification of the technique for use in non-continuous cases may be required.

There is a lack of clarity between the probability level used and the actual performance level of the system. For example, the 98.3% probability level in the statistical method is not equivalent to the 98.3% performance level in the YAS model.

The rationing and stocking method produced considerable lower values. As expected, the individual effects of these modifications was examined by running a no-ration option for Ottawa (Lemieux). It can be seen in Table 4 that external stocking has the greatest effect when the demand is low. This is because the addition of 5 m<sup>3</sup> lasts longer than when the demand is higher. On the other hand, rationing reduces the storage needed more when demand is higher as it is more likely to be invoked.

## FURTHER WORK TO BE DONE

For Canadian conditions, much more work is needed to examine the yield from snowmelt. Methods to improve this yield should be developed. Special construction method may be needed for use of RWCSs in rugged isolated Canadian areas.



The goal of the present work is to compare the methods available and to produce a composite model by incorporating the best features of each to prepare a model that best fits Canadian conditions. A more detailed comparison of the various programmes outlined and used in this paper is especially planned with respect to the different ways that reliability of the RWCS is defined. Particularly, the relationship between the probability level of the statistical method and the actual supply level should be clarified.

A closer examination of the characteristics of the YAS method will be carried out. The effect of different rainfall regimes and the problem of choice of starting date should be examined. The model should be refined to eliminate severe "bends" in the YAS performance curves, such as that in the 1.0 line for Ecum Secum. The envelope curve (shown on the graphs) developed for California would give large values for the Canadian data studied. A flexible means of constructing this curve for each area is needed. For example, it should be noted that the minor bending of the performance curves occurs at about the level of demand that corresponds to the minimum annual rainfall. Further investigation of this and other features could improve the model's effectiveness.

The luxury of external stocking is generally not available to Canadians who would be using rainwater systems. However, the rationing proposal for models of RWCS usage is of significant value and should be considered in the optimization of reservoir sizes.

#### REFERENCES

- Grover, B. 1971. "Harvesting precipitation for community water supplies." International Bank for Reconstruction and Development. iii + 110 p. (unpublished paper)
- Jenkins, D.; Pearson, F.; Moore, E.; Sun, J.K.; and Valentine, R. 1978. *Feasibility of rainwater collection systems in California*. Contrib. No. 173, California Water Resources Center, University of California, Davis. vi + 55 p.
- Perrens, S.J. 1975. Collection and storage strategies for domestic rainwater supply. In *Hydrology Symposium*, Inst. Engr., Armidale, Australia, pp. 168-172.
- Ree, W.O.; Wimberley, F.L.; Guinn, W.R.; and Lauritzen, C.W. 1971. Rainwater harvesting system design. Paper ARS 41-184, Agricultural Research Service, U.S. Department of Agriculture. 12 p.
- Rippl, W. 1883. The capacity of storage reservoirs for water supply. In *Proceedings of the Institute of Civil Engineers*, London, England, vol. 71.

## HYDROGRAPHS FOR ROOF-TOP RUNOFF UNDER VARYING RAINFALL CONDITIONS

Bhaskar Datta  
Assistant Engineer  
Flood Control Dept.  
Gauhati 781003, INDIA

G.C. Mishra, Reader  
School of Hydrology  
University of Roorkee  
Roorkee 247672, INDIA

### INTRODUCTION

With increasing population, water supply systems may fail to satisfy the demand for water. In arid and semiarid regions, especially, the source of water is often depleted. Rain water collected from roof surfaces and utilized through cistern systems can augment the usual domestic supply without large expenditures or energy and can thus meet water shortages.

To design gutters and a cistern system, knowledge of the water surface profile and flow hydrograph is necessary. The kinematics of flow over roof surfaces can be determined from available studies of overland flow. Many investigators have dealt with the problem of overland flow under uniform, excess rainfall either by using the method of characteristics (Behlke 1957; Henderson 1964; Wooding 1965; Morgali and Linsley 1965; Abbott 1966; Brakensiek 1966) or by solving the mass balance equation by assuming a linear relationship between outflow and storage (Horton 1938; Izzard 1944). Wooding (1965) has dealt with the problem of overland flow under a constant, uniformly distributed rainfall of finite duration with an analytical solution for a hydraulic model based on the method of characteristics for flow over a plane which is part of a V-shaped catchment. In reality, the rainfall intensity is not uniform; instead, the distribution is skewed. The typical time variant design of rainfall distribution patterns described by Rodda, Downing and Law (1976) for a 10-year, 5-year and annual return frequencies are shown in Figure 1. Water surface profiles and flow hydrographs for roof surfaces for such design storms can be determined for different intervals of time by using the characteristics equations.

### ANALYSIS

The catchment area includes the 1 meter width of the roof surface (Fig. 2) of length  $l$ , sloping from the apex  $O$  to overflow  $D$  into the gutter. The surface roughness  $\eta$  and slope  $S$  of the roof surface are assumed invariant in space and time. Point  $O$  is the boundary of the catchment. With the onset of rainfall, the water surface profile starts to develop. The depth of water  $y$  in the catchment is a function of distance  $x$  from the boundary and time  $t$  from the onset of rainfall. The flow over the roof surface can be solved by using the continuity and momentum equations which are respectively,

$$\frac{\delta y}{\delta t} + \frac{\delta q}{\delta x} = r \quad (1)$$

and

$$q = \frac{e}{\eta} S_C^{\frac{1}{2}} y^{\frac{5}{3}} \quad (2)$$

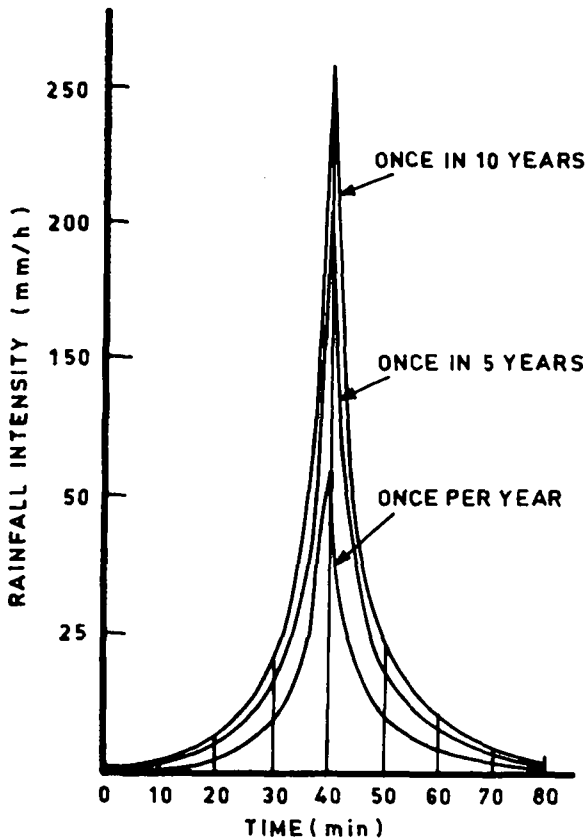

Figure 1. Design storm profiles

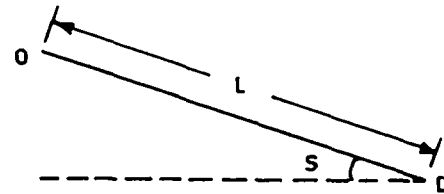

Figure 2. Roof catchment section

where

$y$  = depth of flow

$x$  = distance from boundary of catchment

$q$  = discharge per unit-width

$r$  = rainfall intensity

$t$  = time measured from onset of rainfall excess

$c$  = Manning's constant

$\eta$  = roughness coefficient

$S_0$  = bed slope.

The initial condition for the depth of water is zero throughout the length of the catchment at time  $t = 0$ .

Thus,

$$y(x, 0) = 0 \text{ for } 0 \leq x < L .$$

The boundary condition for the depth of water is zero at the catchment at all times. Thus,

$$y(0, t) = 0 \text{ at } x = 0 \\ \text{for } t > 0 .$$

From the continuity and momentum equations, the characteristics equations are derived as follows:

$$\frac{dx}{\frac{c}{\eta} S_0^{\frac{1}{2}} \frac{5}{3} y^{\frac{2}{3}}} = \frac{dt}{1} = \frac{dy}{r} . \quad (3)$$

In the case of varying rainfall intensity, the response due to boundary excitation does not trace only one smooth curve but continuously traces separate paths. To arrive at the response, the time period of rainfall is divided into a number of small time steps  $\Delta t$  and the rainfall intensity is assumed to be uniform within each time step but varies from time step to time step. The rainfall intensities at different time steps are shown in Figure 3. The water surface profiles at the end of each time step from the onset of rainfall are shown in Figure 4.

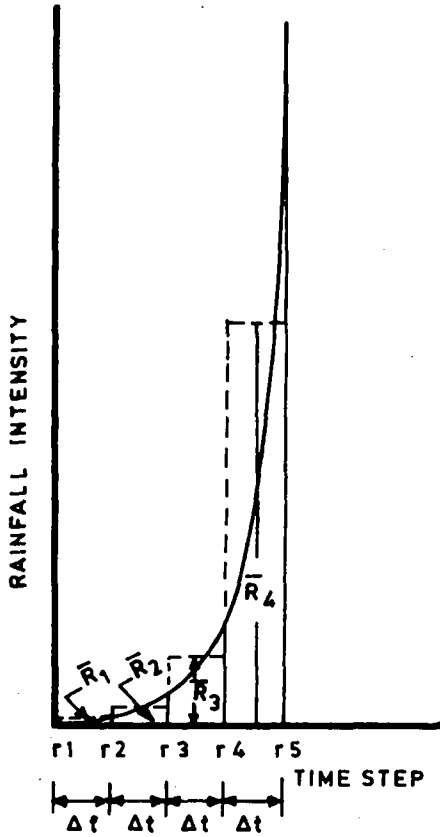

Figure 3. Average rainfall intensity in different time step

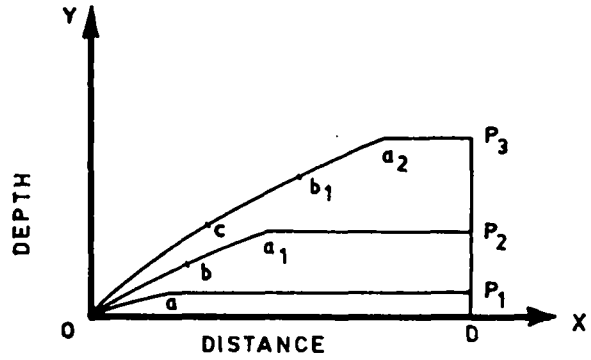

Figure 4. Water surface profiles

The average value of rainfall excess during the  $n$ th interval of time is expressed as  $\bar{R}(n)$ , as

$$\bar{R}(n) = \frac{r(n) + r(n + 1)}{2} \quad (4)$$

where

$r(n)$  = value of rainfall excess at beginning of  $n$ th time step

$r(n + 1)$  = value of rainfall excess at end of  $n$ th time step.

From the characteristics equation,

$$\frac{dy}{dt} = \bar{R}(n) , \quad (5)$$

let  $(x_{n-1}, y_{n-1})$  be the coordinate of a point in the water surface profile at time  $t_{n-1}$ ,

$t_{n-1}$  being equal to  $(n - 1) \cdot \Delta t$ . In time  $\Delta t$ , this point moves to a new point whose coordinate is given by  $(x_n, y_n)$ .

Thus from equation (5),

$$dy = \bar{R}(n) dt ,$$

integrate time  $t_{n-1}$  to  $t_n$  as

$$\int_{y_{n-1}}^{y_n} dy = \int_{t_{n-1}}^{t_n} \bar{R}(n) dt$$

or

$$y_n = y_{n-1} + \bar{R}(n)(t_n - t_{n-1}) . \quad (6)$$

Again from the characteristics equation,

$$dx = \frac{c}{\eta} S_0^{\frac{1}{2}} \frac{5}{3} y^{\frac{2}{3}} dt ,$$

integrate from time  $t_{n-1}$  to  $t_n$  as

$$\int_{x_{n-1}}^{x_n} dx = \frac{c}{\eta} S_0^{\frac{1}{2}} \frac{5}{3} \int_{t_{n-1}}^{t_n} y^{\frac{2}{3}} dt . \quad (7)$$

Then substitute  $y = y_{n-1} + \bar{R}(n)(t - t_{n-1})$  in equation (7) and integrate as

$$x_n = x_{n-1} + \frac{c}{\eta} S_0^{\frac{1}{2}} \frac{5}{3} \frac{[y_{n-1} + \bar{R}(n)(t_n - t_{n-1})]^{\frac{5}{3}} - y_{n-1}^{\frac{5}{3}}}{\frac{5}{3} \bar{R}(n)} \quad (8)$$

Using equation (6), equation (8) reduces to

$$x_n = x_{n-1} + \frac{c}{\eta} \frac{S_0^{\frac{1}{2}}}{\bar{R}(n)} [y_n^{\frac{5}{3}} - y_{n-1}^{\frac{5}{3}}] \quad (9)$$

From equations (6) and (9), the water surface profile at the end of the successive time step can be determined.

For a continuous period of rainfall, the depth of water at the end of the  $n$ th time interval is expressed as

$$y(L, n) = \sum_{i=1}^n \bar{R}(n) \cdot \Delta t$$

if the boundary excitation has not reached the outfall. Thus,

$$q = \frac{c}{\eta} S_0^{\frac{1}{2}} [y(L, n)]^{\frac{5}{3}}$$

is the flow rate from 1 meter width of catchment, and value  $q$  at the end of the successive time step is the flow rate.

## RESULTS AND DISCUSSION

Results have been obtained for  $c = 1.0$ ,  $\eta = 0.008$ ,  $L = 20$  m and  $S = 0.3333$ . The excitation for which the response has been obtained is given in Table 1.

TABLE 1. AVERAGE VALUE OF RAINFALL EXCESS  $\bar{R}(n)$  AT DIFFERENT TIME STEPS

TIME STEP (s)	n	STORM OCCURRENCE		
		1 yr	5 yr	10 yr
		----- (10 <sup>-5</sup> m/s) -----		
0- 600	1	0.0125	0.0250	0.0347
600-1200	2	0.0472	0.1013	0.1291
1200-1800	3	0.1736	0.3194	0.3805
1800-2400	4	0.9721	2.9319	3.6888
2400-3000	5	0.9763	2.9471	3.7235
3000-3600	6	0.2097	0.3791	0.4777
3600-4200	7	0.0916	0.1736	0.2236
4200-4800	8	0.0250	0.5277	0.0666

The time period of rainfall is divided into eight equal parts. Figure 5 shows the average value of rainfall intensity in different time steps for an annual design storm. Water surface profiles developed at the end of each time step due to varying rates of rainfall intensities are shown in Figure 6.

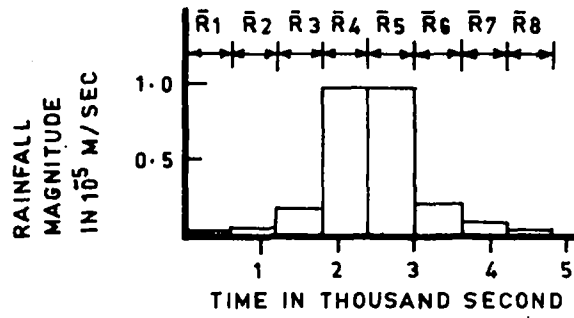

Figure 5. Rainfall hyetograph for annual design storm

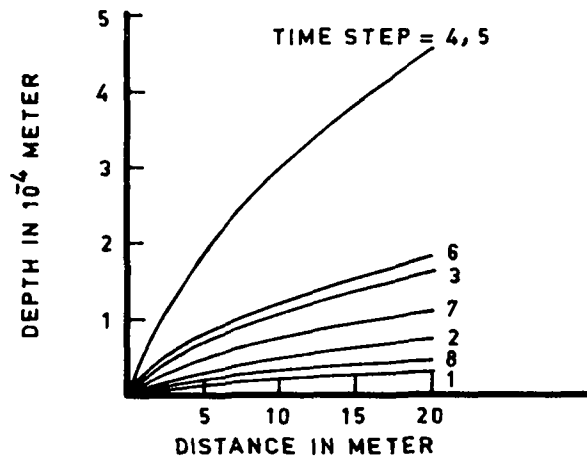

Figure 6. Roof slope water surface profiles at end of different time steps for annual design storm

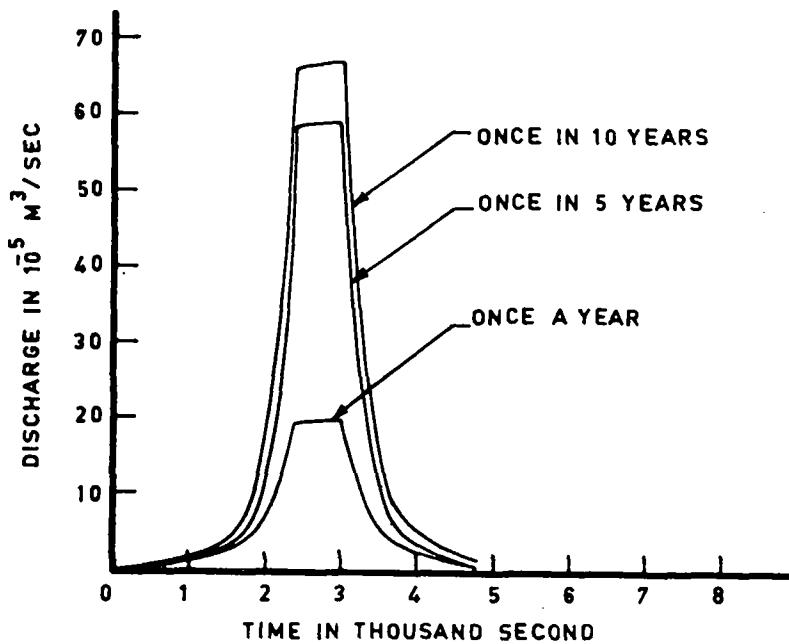

Figure 7. Flow hydrographs for design storms

As the rainfall intensity increases, the water surface profile rises higher and then drops as the rainfall intensity decreases. Thus, the changes in the rainfall intensity is directly reflected in the water surface profile.

Figure 7 is a flow hydrograph of design storms of annual, 5-year and 10-year frequencies. The average value of rainfall intensity remains almost the same for the 4th and 5th time steps, for which the rate of flow remains constant for the 5th time step.

#### CONCLUSION

The water surface profiles and flow hydrograph pertaining to a roof surface for nonuniform rainfall can be determined by using the method of characteristics.

#### REFERENCES

- Abbott, M.B. 1966. An introduction to method of characteristics. London: Thames and Hudson.
- Behlke, C.E. 1957. Mechanics of overland flow. Stanford University, California.
- Brakensiek, D.L. 1966. Hydrodynamics of overland flow and nonprismatic channel. Trans. Am. Soc. Agr. Engr. 9(1):119-122.
- Henderson, F.M., and Wooding, R.A. 1964. Overland flow and interflow from a limited rainfall of finite duration. J. Geophys. Res. 69(8)1531-1540.
- Horton, R.E. 1938. The interpretation and application of runoff plot experiments with reference to soil erosion problems. Soil Sci. Soc. Am. Proc. 3:340-349.
- Izzard, C.F. 1944. The surface profile of overland flow. Trans. Am. Geophys. Union 25(6):959-968.
- Morgali, J.R., and Linsley, R.K. 1965. Computer analysis of overland flow. J. Hydraul. Div., Am. Soc. Civ. Eng. 91(HY3):81-100.
- Rodda, J.C.; Downing, R.A.; and Low, F.M. 1976. Design storm profiles. In Systematic hydrology, p. 60. London: Newnes-Butterworth.
- Wooding, R.A. 1965. A hydraulic model for the catchment-stream problem. I. Kinematic-wave theory. J. Hydrol. 3(3/4):254-267; II. Numerical solutions. J. Hydrol. 3(3/4):268-282.

## DESIGN STRATEGY FOR DOMESTIC RAINWATER SYSTEMS IN AUSTRALIA

S.J. Perrens, Head  
Resource Engineering Department  
University of New England  
Armidale, New South Wales, 2351 AUSTRALIA

## ABSTRACT

*Any closed rainwater supply system involving a sealed or almost impervious catchment, a storage and a linked supply point may be characterized by some general relationships regardless of the size of the system. This paper presents the results from a simulation model of the operation of such water supply systems at four locations in New South Wales, which are representative of the range of rainfall regimes in Australia. The results are presented in the form of generalized design graphs. Although this study refers particularly to Australia, the principles involved are applicable to any rainwater supply system.*

## INTRODUCTION

Although the majority of the Australian population are urban dwellers who rely on reticulated water supplies, there remain about 1 million people who rely on rain water as their primary source of supply. Traditionally, the Australian "outback" farm has had to be entirely self-sufficient for domestic water supply. More recently, the urban fringe of many Australian towns and cities have been subjected to the phenomenon of "hobby farm" development. This has created population densities which are too low for new reticulated supplies to be economically justified.

A number of sources of water have been traditionally exploited by rural dwellers including:

1. Roof and tank systems
2. Farm dams
3. Natural "permanent" water such as waterholes in creeks or lagoons
4. Bores or wells to extract groundwater.

The choice between the various sources is usually restricted to no more than two for practical or climatic reasons. The choice between any two options is a function of the capital cost of the supply, its reliability, the consequences of "failure", and the quality of the water it yields.

Despite the widespread use of rainwater systems, there is a paucity of design data available for Australia. Most systems are installed on the basis of local folklore and frequently encompass the misconception that a large storage can, of itself, be equated with a more reliable supply or greater yield from the system.

Such work as has been done on this subject in Australia has not received the attention it deserves in view of the widespread use of rainwater systems.



Ragg (undated) of the Water Resources Commission of N.S.W. provides some guidance for the design of roof catchment systems based on the concept of providing a minimum storage which was directly related to the average annual rainfall as follows:

<u>Average Annual Rainfall (mm)</u>	<u>Storage (days)</u>
<380	180
380-630	120
>630	90

This concept of using average annual rainfall as an indicator of storage requirements has been widely used in Australia where high variability of rainfall tends to be directly related to low rainfall.

Body (1968*a, b*) of the Australian Commonwealth Bureau of Meteorology has studied the feasibility of rainwater supply for both single houses and communities requiring up to 500,000 l/day. His study was a prelude to producing generalized design data covering the entire continent. Unfortunately, the results of the study, which include extensive analysis of the effects of rationing on reliability of supply, have only been issued as "in-house" documents.

In a prelude to this study, Perrens (1975*a*) presented a preliminary analysis of the relationships between the major elements of a rainwater supply system for one locality in Australia and pointed out the importance of rationing policy on the reliability of supply for practical systems under Australian conditions. The study also showed that significant yield could be achieved for relatively minor storages from typical urban houses and suggested that a new strategy for urban fringe development, or urban water supply reduction, could be based on such storages. This theme was expanded by Perrens (1975*b*) to examine some aspects of supplementary urban supply from rain water.

One other aspect of Australian research also deserves mention here. Hollick (1974) studied the design parameters of "roaded" catchments for optimum yield. "Roaded" catchments are shaped to provide a series of parallel roads, smoothed and then compacted to minimize infiltration and maximize runoff. Although different from a roof or paved rainwater collection system, there are nevertheless close parallels between the two.

This paper delineates the main design parameters associated with rainwater supply systems and the relationships between various elements of such systems. The data presented may then be used to design rainwater systems on a rational basis, evolve an optimal design and compare such a design with alternative sources of supply. The design method is generalized and can be applied to single buildings, groups of buildings or community supplies from artificial catchments.

A companion paper (Perrens 1982), "Effect of Rationing on Reliability of Domestic Rainwater Systems," which is also presented at this conference, explores the trade-off between rationing, reliability, and the other elements of the rainwater system.

#### OUTLINE OF INVESTIGATION

GENERAL. A simulation model was developed to analyze the behaviour of

a simple impermeable catchment feeding directly into an enclosed storage from which a specified demand was met. For purposes of this particular study, four locations in New South Wales (Fig. 1) were chosen for analysis as representative of the major climatic zones.

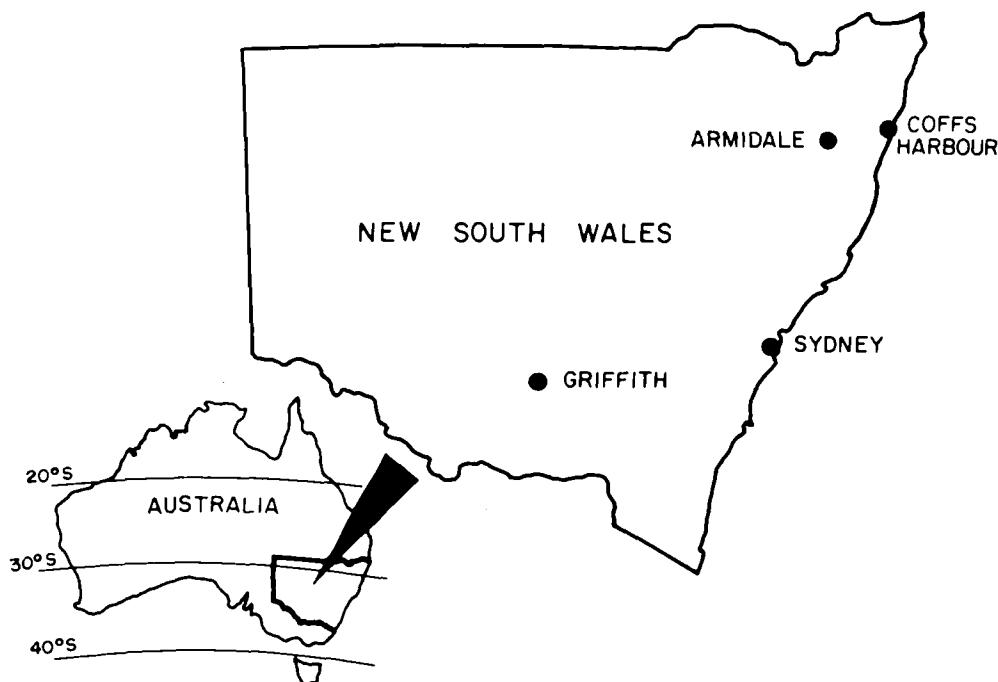

Figure 1. Location of sites studied, New South Wales

Armidale is representative of a temperate highland climate with a mild seasonal dominance of rainfall towards the summer months. Coffs Harbour is representative of a coastal subtropical climate with a dominance of summer and autumn rainfall. Griffith is representative of a hot arid climate with highly variable rainfall which exhibits no seasonal dominance. Sydney is representative of a coastal temperate climate exhibiting no seasonal dominance of rainfall. Table 1 below gives some of the major climatic and geographic features of the locations chosen.

TABLE 1. CLIMATIC CHARACTERISTICS OF LOCATIONS STUDIED

	Armidale	Coffs Harbour	Griffith	Sydney
Latitude (S)	30°31'	30°19'	34°16'	33°52'
Altitude (m)	980	2.7	131	92
Mean annual rainfall (mm)	795	1759	391	1216
Median annual rainfall (mm)	771	1614	382	1160
Mean winter rainfall JJA	162	296	104	315
Mean spring rainfall SON	202	273	101	227
Mean summer rainfall DJF	276	615	90	293
Mean autumn rainfall MAM	155	575	96	381
Years of record	110	60	60	130
Rain days/year	110	147	76	139

MODEL DETAILS. For each time period, the simulation model determined the runoff, which would occur as a result of rainfall on the impervious area, after making an allowance of 2 mm for initial loss due to evaporation or very light falls of rain. For a specified tank size, a simple water budget was kept (assuming no evaporation loss). This allowed for inflow, meeting of demand, and overflow if excess rainfall occurred. For purposes of the study reported here, no rationing was allowed for and the full demand was satisfied until the storage was empty. When this occurred, a small replenishment of the storage amounting to 10 days supply was allowed. This replenishment is used in practice by many households both on the urban fringe and in "the bush". The urban fringe dwellers obtain relief by purchasing 5000 ℓ of water which is brought in a road tanker. More remote dwellers resort to obtaining water from other lower quality sources, such as groundwater, in times of crisis.

The model was run for a range of parameters to explore the relationships between demand, catchment area, storage volume and reliability of supply. Various statistics relating to the performance of each combination were retained for analysis.

In each case, the full historic record from each site was used for the analysis. No attempt was made for this study to devise a rainfall simulation model to extend the period of record because sufficiently precise definition of probabilities could be achieved using historic records.

## RESULTS AND DISCUSSION

The original model was specifically developed to investigate household rainwater systems. It became apparent, however, that the model could be generalized to suit any sized system in which the major determinant of size was the average demand placed on the system. For this study, the demand was defined in terms of litres/day for the particular system. Once the demand is defined, the minimum catchment area required to satisfy this demand over a year, given an average year's rainfall is defined by

$$A = 365 D/R \quad (1)$$

where

A = catchment area (m<sup>2</sup>)

D = daily demand (ℓ)

R = average annual rainfall (mm).

This catchment area has been termed the "basic" area and the relationship given in equation (1) is graphically presented in Figure 2.

Figure 2 therefore provides a mechanism for considering a catchment area which is independent of the absolute size of the system. Similarly, the storage required can be made independent of the absolute size by specifying it in terms of days of storage which will satisfy the specified demand. This approach has been used for this study, and a typical set of the model results for one location, Coffs Harbour, are presented in Figure 3.

Two particular aspects of the general relationships shown in Figure 3 are worthy of note. Firstly, there is a distinct trade-off to be made between the storage volume and collection area required to give a specified supply with a given reliability. For a given reliability it can be seen that the curve is approximately asymptotic to limiting values of the storage and collection area. These represent the two basic limitations of any water supply system: sufficient area to generate the required runoff and sufficient storage to ensure supply in periods of low or zero runoff. These two concepts are not usually recognized as being fundamental to the design of a rainwater system.

Secondly, it can be seen that for increased reliability an increase in storage or catchment area is required. For instance, a house at Coffs Harbour having 140 days supply in storage and 1.23 times the basic collection area would expect "failure" twice per year on average. To improve the reliability to a "failure" on an average of once in five years, the collection area must be increased to 370 days (160% increase). The curves presented in Figure 3 may also be used to define the required storage and catchment area to provide an

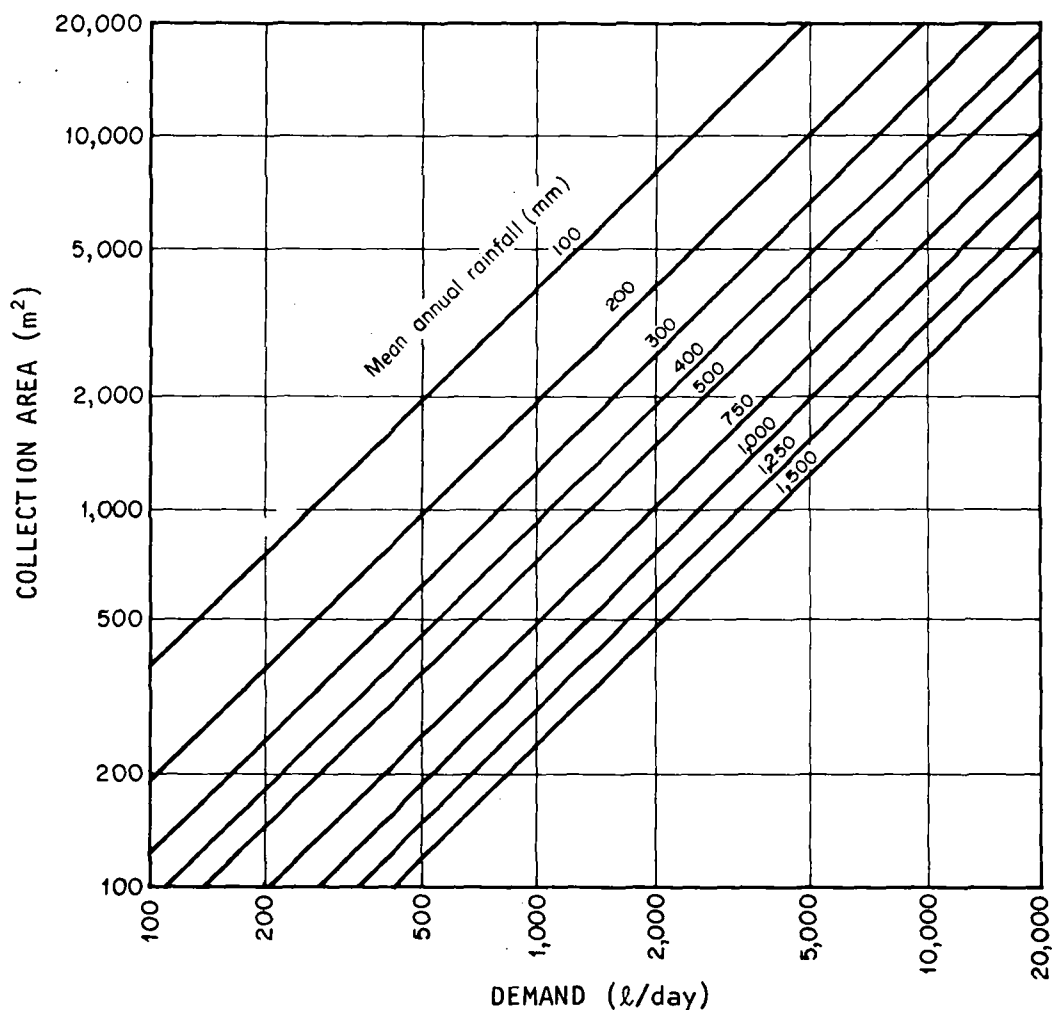

Figure 2. Minimum impervious catchment area required to meet a specified demand for a given mean annual rainfall

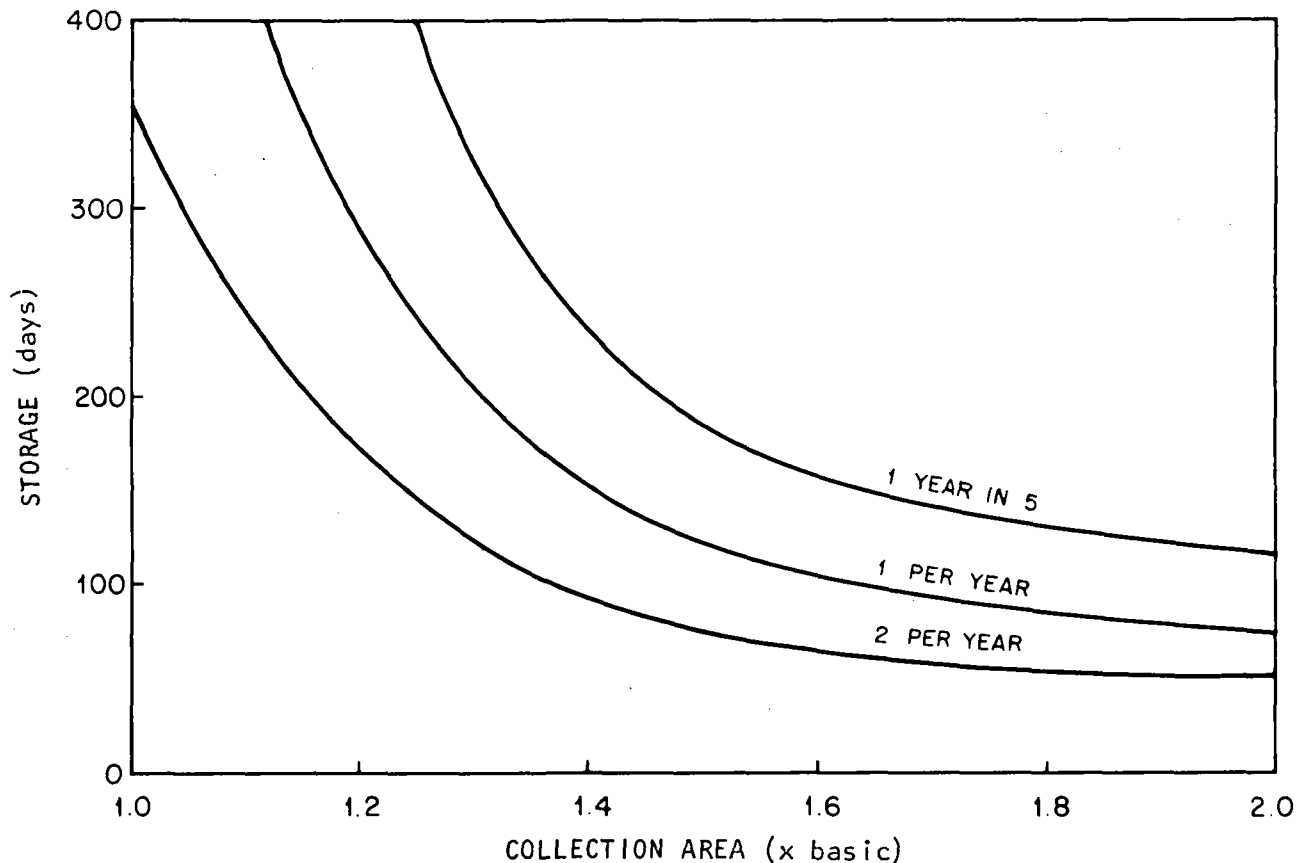

Figure 3. Relationship between collection area and storage for Coffs Harbour for a given demand for various probabilities of "failure"

increase in supply. Also, as each curve defines the range of storage sizes and catchment areas required to provide any specified demand, the costs of construction can be used to transform each curve to define the minimum cost solution to a particular supply problem.

Figures 4 and 5 present the storage-to-area relationships for probabilities of failure of once per year and one in five years for the four locations chosen. The most interesting aspect of these curves is the way they reflect the seasonal and annual variability of the rainfall at each center. By reference to Table 1 it can be seen that Armidale and Sydney have less seasonal variability than Coffs Harbour. This is reflected in the fact that Armidale and Sydney require proportionately less storage for a given collection area. The curves can however be deceptive because the basic area required in Armidale will be about 2.3 times that required for Coffs Harbour. Therefore, the curves must only be interpreted relative to the mean annual rainfall for the area in question.

The curves for Griffith are very similar to those for Coffs Harbour. It may at first appear anomalous that the locations with the highest and lowest rainfall studied should appear so similar. However, as has already been emphasized, the data in Figures 4 and 5 express the relative variability of rainfall at each location. Although not apparent from the data in Table 1,

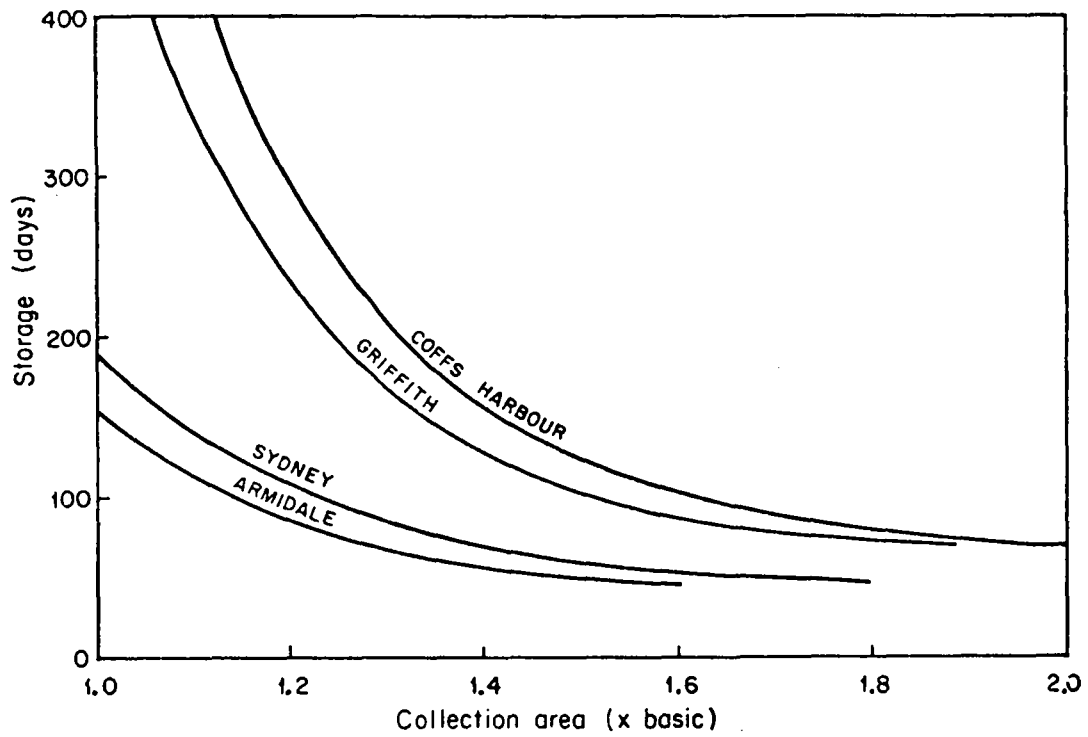

Figure 4. Acceptable combinations of catchment area and storage volume for four locations for a "failure" of once per year

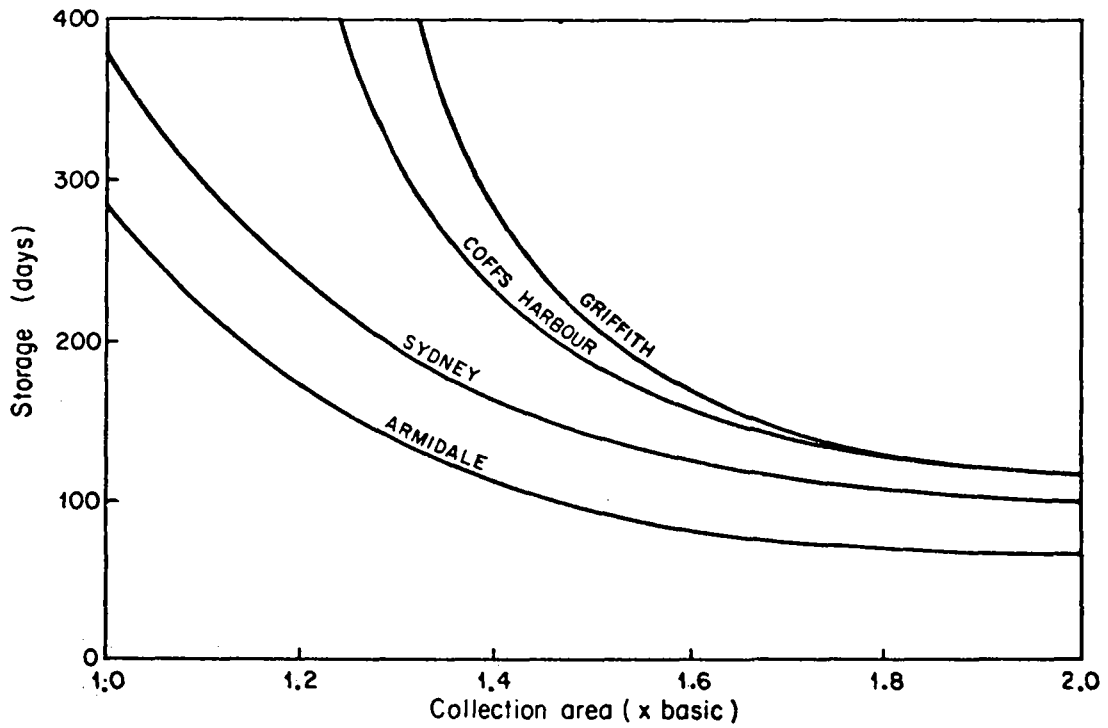

Figure 5. Acceptable combinations of catchment area and storage volume for four locations for a "failure" of once in five years

Griffith has a higher variability of rainfall from year to year than the other locations studied. This gives rise to the similarity between the curves for Coffs Harbour and Griffith.

Figure 6 shows the relationship between reliability of supply and storage requirements for a typical system having 1.3 times the basic area at Armidale and Coffs Harbour. In each case the form of the curve is similar, reflecting the increase in storage required to increase the reliability of supply. In both cases, if the collection area remains constant, approximately threefold increase in storage is required to improve the reliability from an average of two failures per year to an average of one failure in five years. Such a solution might not be acceptable in practice and an alternative of simultaneous increase in storage and catchment area might be used to achieve an increase in reliability at a lower cost.

Interpretation of the results presented for practical situations gives some insight into the limitation of many rainwater supply systems in Australia. Firstly, it can be seen that there is a basic minimum storage required in any location for a given reliability. For failure of once in five years these are

Armidale .....	60 days
Sydney .....	100 days
Coffs Harbour and Griffith.....	120 days

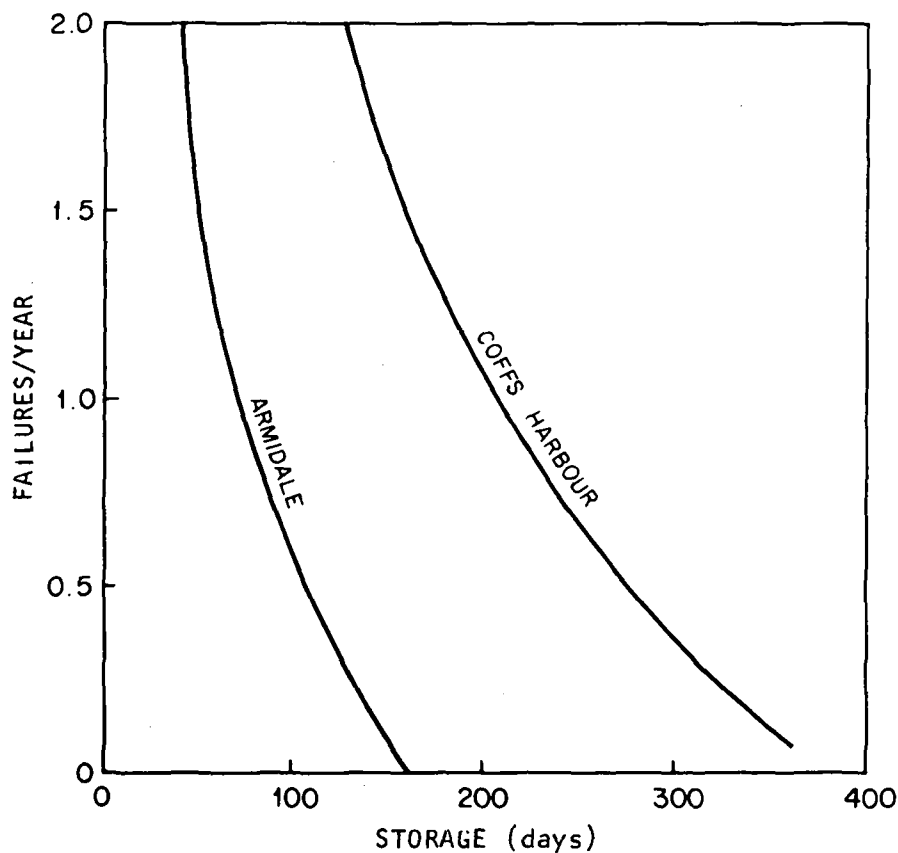

Figure 6. Effect of acceptable reliability of supply on the storage requirements for a system having 1.3 times the basic catchment area

It can be readily seen that these results do not agree with those presented by Ragg (undated) and summarized in the Introduction. This would suggest that, average annual rainfall is not as well correlated with variability as is often presumed. This is not unexpected because no account is taken of seasonal variability with this technique.

Secondly, the results presented seem to indicate that most practical rainwater supply systems should have catchment areas in the range of 1.2 to 1.6 times the basic area depending on the required reliability and the economic trade-offs which can be made between storage and catchment area. Nevertheless, for the four areas studied, comparison of practical systems is instructive. Assume a household of four adults each using about 200 ℓ/day, which is about average for rural dwellers in Australia. An assumed 1.3 times the basic area and storage required for that area may be calculated for each location as shown in Table 2 for a probability of failure of once in five years.

TABLE 2. RAINWATER SYSTEM DETAILS FOR A HOUSEHOLD REQUIRING 800 ℓ/DAY WITH A PROBABILITY OF FAILURE AVERAGE OF ONCE IN FIVE YEARS

Location	Average Annual Rainfall (mm)	Basic Roof Area x 1.3 (m <sup>2</sup> )	Storage (m <sup>3</sup> )
Armidale	796	480	112
Coffs Harbour	1795	220	252
Griffith	391	965	336
Sydney	1216	320	126

These results suggest that meeting such a demand would only be possible in Coffs Harbour or Sydney with a large house (by Australian Standards) or with a more modest house which also collected runoff from sheds and stables. The specified demand would be very difficult to meet in Armidale and impossible to meet in Griffith. Under these circumstances, given some practical limitations to the size of roof commanded by one household, the household can either elect to reduce its demand or accept a greater probability of failure. These results suggest that such strategies may be a common feature of rainwater systems in Australia.

#### CONCLUSIONS

Rainwater systems have been shown to have clear trade-offs between catchment area, storage size, and reliability of supply for a specified demand. By expressing the design parameters in relation to the daily demand from the system and the average annual rainfall at the locality in question, general relationships have been derived which are independent of the absolute size of the system. Such curves may be used in conjunction with costs of storage and catchment area to evolve an economically optimum design for any new situation or to upgrade an existing system.

The use of such data also provides a basis for economic comparison of alternative sources of supply for any locality.



The data presented also provides a basis for the design of artificial catchments which are not fully impervious, such as "roaded" catchments. By increasing the basic catchment area in an inverse proportion to an assumed runoff coefficient, the data presented may be used for such systems.

## REFERENCES

- Body, D.N. 1968 . Design information for domestic water supply from roof runoff. Progress Report, Commonwealth Bureau of Meteorology, Melbourne. 28 p.
- \_\_\_\_\_. 1968 . Design of water supply services based on impervious catchment areas. Progress Report, Commonwealth Bureau of Meteorology, Melbourne. 11 p.
- Hollick, M. 1974. "Road catchments for farm water supply." Ph.D. dissertation, University of Western Australia. 287 p.
- Perrens, S.J. 1975 . Collection and storage strategies for domestic rain-water supply. Hydrology Papers, Inst. Eng. Australia, Canberra, pp. 168-172.
- \_\_\_\_\_. 1975 . Alternative sources of water supply. In Conference on Water Resource Management in Country Residential Centres, Inverell, Australia, 18 p.
- \_\_\_\_\_. 1982. Effect of rationing on reliability of domestic rainwater systems. In Proc. Int. Conf. Rain Water Cistern Systems, ed. F.N. Fujimura, Honolulu, Hawaii, pp. 302-310.
- Ragg, H.A. n.d. Design of roof catchment water supply systems. Water Resources Commission of N.S.W., Sydney, Australia. 5 p.

## FEASIBILITY ANALYSIS OF RAIN WATER CISTERN SYSTEMS AS AN URBAN WATER SUPPLY SOURCE

Shuichi Ikebuchi, Professor  
Water Resource Research Center  
Disaster Prevention Research Institute  
Kyoto University  
Gokasho, Uji, Kyoto 611, JAPAN

and

Seiji Furukawa, Consultant Engineer  
New Japan Engineering Consultant Company  
Nagahoribashi, Minamiku, Osaka 542, JAPAN

### INTRODUCTION

In the past, dam reservoirs were constructed to meet the increasing water supply demand as a result of the growth in population and urbanization. In recent years, however, social pressures and environmental controls have made it more difficult to construct dam reservoirs; thus, a comprehensive water supply system has become an increasingly important planning guide. With this in mind, we propose the integration of rain water cistern systems into existing water supply systems.

In Japan, there are a few examples of rain water cistern systems that are limited to the roof catchment and storage of rain on individual buildings or houses. Judging from the scale effect and the operation and maintenance of this system, the collective form seems to be more efficient and effective than small, individual rain water cistern systems. As presented in this paper, the collective form of rain water cistern systems relates to the expansion of roof catchment areas of many buildings in the urban area. The assets of this sort of system are threefold: (1) a supplemental source of potable water to the existing water supply system, (2) a means of diminishing and utilizing storm runoff, and (3) a method of decreasing the amount of treatment necessary for the combined sewer system.

### ANALYTICAL ASPECTS FOR THE DESIGN AND DEVELOPMENT OF RAIN WATER CISTERN SYSTEMS

In our plan for a rain water cistern system, the rain water collected and stored from roofs would be used for flush toilets, the average water demand for which is about 30% of the urban water demand. Storage tanks can be placed in the basement of parking areas and high-rise buildings and the stored water pumped up to flush toilets on each floor through treatment and delivery systems.

There are some analytical, technological, and policy aspects of this rain water cistern system. Examples are (1) to find out the functional relationship between the frequency and volume of water shortages and the stochastic characteristics of the rainfall time series, the capacity of the storage tank, the size of the catchment area, and the amount of water demand for flush

toilets; (2) to design the rain water cistern system based on the above functions; (3) to check the water quality of the rain water cistern system; (4) to check the safety of the system in relation to possible earthquake for tank construction in building basements; (5) to analyze the cost of the conduit systems for collecting and delivering rain water; and (6) to estimate the institutional constraints and to investigate the user's response to this system and possibility of his agreement and acceptance.

In this paper aspects (1), (2), and (3) will be mainly discussed and their feasibility will be analyzed based on the hydrological and socioeconomic data in the urban area of Japan.

FEASIBILITY ANALYSIS FROM HYDROLOGICAL POINT OF VIEW

FEASIBILITY ANALYSIS PROCEDURES. Figure 1 shows the fundamental procedures for feasibility analysis from the hydrological point of view.

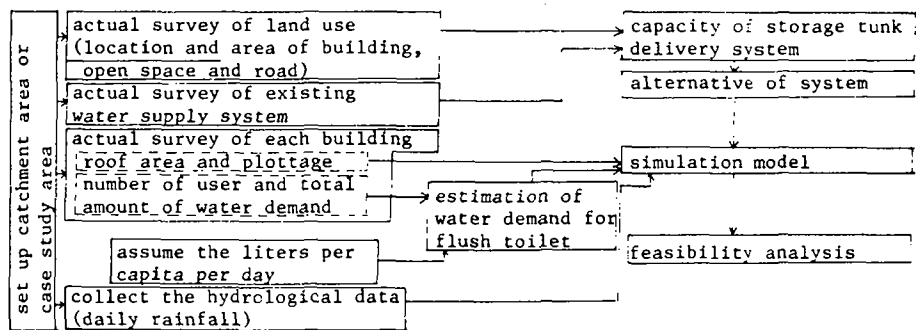

Figure 1. Flow chart of feasibility analysis

SET UP THE CASE STUDY AREA. Area 2 shows the case study area for the rain water cistern system.

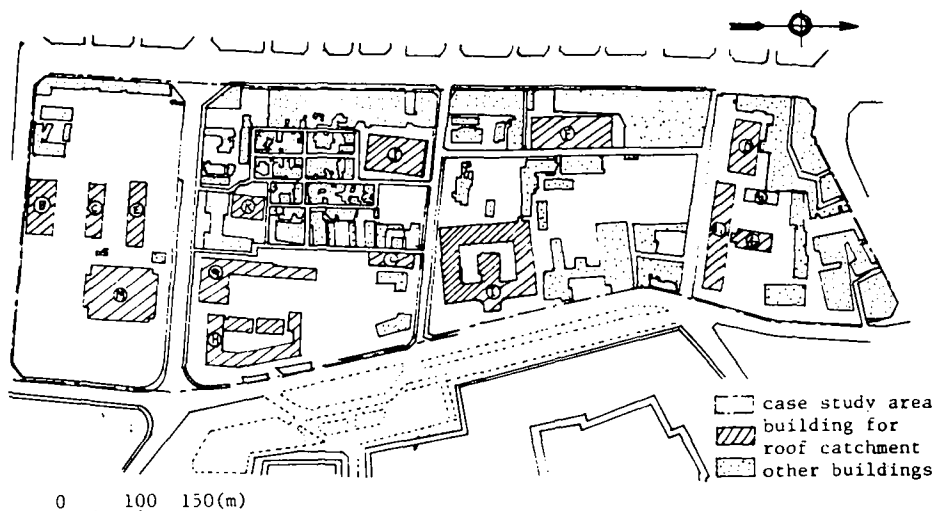

Figure 2. Case study area, Osaka, Japan

The study area is located in the immediate neighborhood of Osaka Castle and in the second largest city in Japan. Through surveys and from a topological map, it is found that the total size of the area is 0.262 km<sup>2</sup> and that the percentage of land use for buildings, open space, and roads is respectively 32.6, 58.6, and 8.8%. There are a number of federal and local government offices in this area. Therefore, the feasibility for the rain water cistern system is greater than that of private buildings. The hatched areas in Figure 2 show the locations of buildings recommended for the roof catchment of rain. Figure 3 indicates the profile of those buildings.

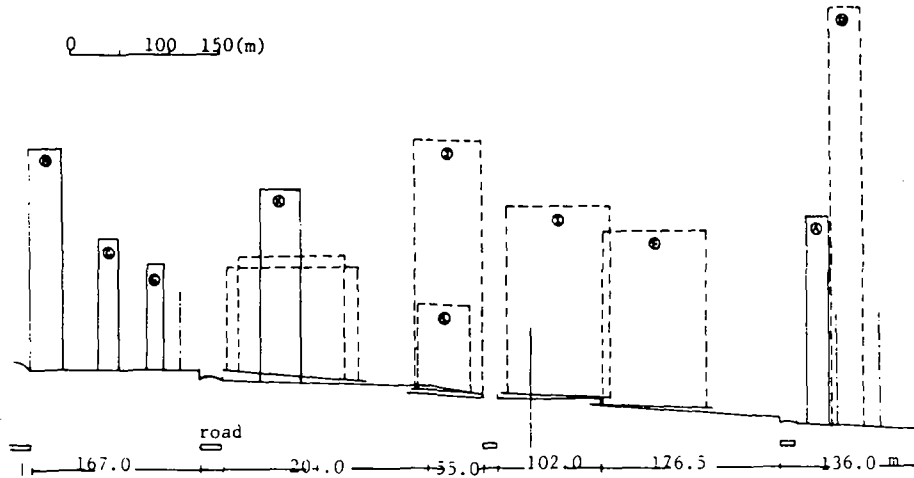

Figure 3. Profile of case study area

**DATA SOURCES.** The data for the cistern system were obtained from questionnaires to building occupants or by actual surveys of this area. A summary of the roof catchment areas is presented in Table 1.

**Water Demand.** The water demand for flush toilets was estimated on the basis of cubic meters per year (Table 2), and for various uses in cubic meters per day (Table 3).

TABLE 2. WATER DEMAND ESTIMATES FOR FLUSH TOILETS

Building	Water Demand (m <sup>3</sup> /yr)
A	15 422
B	10 206
C	2 041
D	18 371
E	3 379
F	9 185
G	3 289
H	26 762
I	22 567
J	18 371
K	4 513
L	1 678
M	1 315

TABLE 1. SUMMARY OF BUILDINGS A-M

Plottage	94 201 m <sup>2</sup>
Roof area	35 662 m <sup>2</sup>
Floor area	231 759 m <sup>2</sup>
Users	13,447 persons
Water demand	453 878 m <sup>3</sup> /yr

TABLE 3. WATER DEMAND ESTIMATES FOR EACH USE

Use	m <sup>3</sup> /day	%
Flush toilet	423	25.0
Wash basins	73	4.3
Water heater	114	6.7
Kitchen	404	23.9
Cooling tower	378	22.3
Other uses	301	17.8
Total	1 693	100.0

**Rainfall.** In the immediate neighborhood of this area, there is the Osaka Meteorological Center which has daily rainfall records from 1926. From these records, the yearly mean rainfall precipitation is 1 324.3 mm.

**STORAGE TANK AREAS.** The construction and placement of storage tanks is more feasible in open spaces than in the basements of existing buildings. In this area, open spaces include: public gardens (13 000 m<sup>2</sup>), school grounds (6 000 m<sup>2</sup>), and parking areas (6 500 m<sup>2</sup>).

**DESIGN OF SYSTEM.** Figure 4 shows the yearly mean ratio of water supply from the roof catchment of rain water to water demand for flush toilets in each building. Judging from the balance between water supply and demand, length of delivery system, and the profile of ground level, the following system was designed. The system includes the collection of rain water from roof catchment of 13 buildings (A-M), and delivery through a conduit system to a storage tank in the basement of the parking area near building A. Then the stored water is pumped up to tanks on the roof and the ninth floor of building D to be used for flush toilets only in buildings A and D. The collection and delivery system of rain water is shown in Figure 5, and the pumping and supply system in Figure 6.

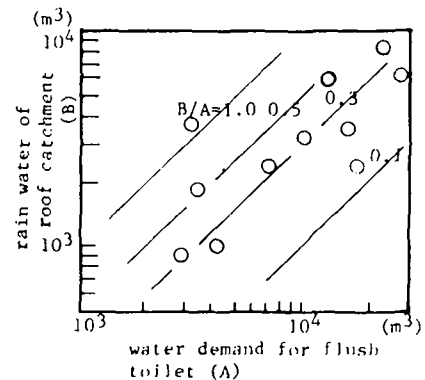

Figure 4. Water supply to demand ratio

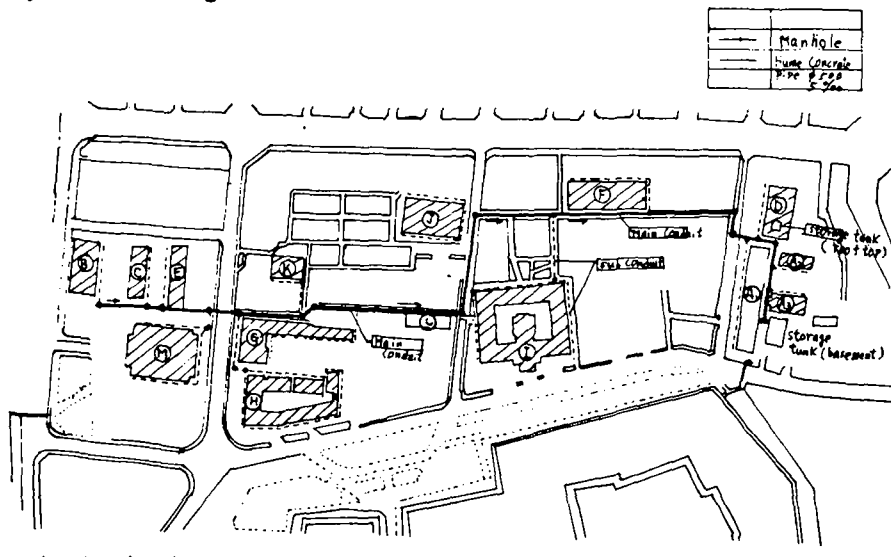

Figure 5. Collection and delivery systems

**SIMULATION MODEL.** When analyzed as an hydrological problem, the rain water cistern system is equivalent to a reservoir problem. That is, the inflow, the reservoir, and the discharge correspond respectively to the collected rain water, the storage tank, and the water demand for flush toilets. The reliability of water supply, therefore, is the function of a rainfall time series and their stochastic characteristics, roof catchment area, storage tank capacity, and water demand for flush toilets. In this paper we analyze the reliability or feasibility of the cistern system based on the following simulation

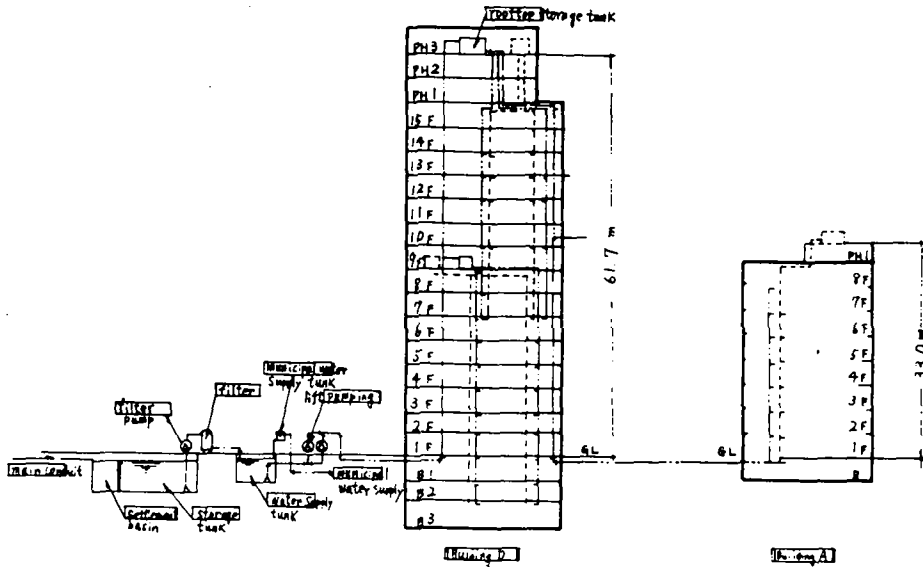

Figure 6. Pumping and supply systems

model where the fundamental equation is

$$S(t + 1) = S(t) + I(t) - O(t)$$

where  $I(t)$ ,  $O(t)$ , and  $S(t)$  are the rain water collected respectively from roof catchment, the water demand for flush toilets, and the storage volume of the storage tank at  $t$ -th day. In this case,  $I(t)$  is expressed as

$$I(t) = A \cdot [R(t) - l_s] \cdot 10^{-3} \quad ; \quad R(t) > l_s$$

$$I(t) = 0 \quad ; \quad R(t) \leq l_s$$

where  $A$  is the total area of roof catchment in  $m^2$ ,  $R(t)$  the daily rainfall in mm/day, and  $l_s$ , the initial loss for depression storage on the roof receiving rain water in mm. In the process of time, if  $S(t + 1)$  has a negative value, then the water shortage occurs and its volume is equal to  $-S(t + 1)$ . In contrast with this, if  $S(t + 1)$  exceeds the capacity of storage tank  $V$ , overflow occurs and its volume is equal to  $S(t + 1) - V$ .

Conditions and Cases for Simulation.

$I(t)$ (mm/day)	Daily rainfall for Osaka, 1926-1965
$A$ ( $m^2$ )	35 662
$O(t)$ ( $m^3$ /day)	104.3; week days, 73.0; Saturday, 53.2; Sunday
$V$ ( $m^3$ )	Case 1; 1 000, case 2; 3 000, case 3; 5 000
$l_s$ (mm)	2.0

The storage tank capacities of 1 000, 3 000, and 5 000  $m^3$  correspond to those that provide a water supply even when the no-rainfall duration times are 10, 30, and 50 days. The initial volume of the storage tank was assumed as

$$S(1) = V/3 .$$

Simulation Results. Table 4 shows the reliability of water supply and the

occurrence probability of overflow in accordance with the storage tank capacity.

TABLE 4. RELIABILITY OF WATER SUPPLY AND OCCURRENCE PROBABILITY OF OVERFLOW

CAPACITY (m <sup>3</sup> )	YEARLY MEAN		SUMMER SEASON MONTHLY MEAN	
	Reliability of Water Supply ----- (Percent)	Probability of Overflow -----	Reliability of Water Supply ----- (Percent)	Probability of Overflow -----
1 000	71.7	35.0	75.9	47.4
3 000	85.7	25.0	94.1	37.3
5 000	91.4	20.9	96.9	33.0

Figures 7.1 to 7.3 show respectively the variation or pattern of the monthly mean for frequency, volume of water shortage, and the volume of overflow.

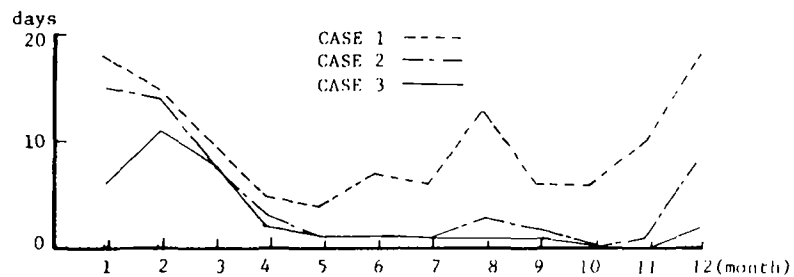

Figure 7.1. Monthly mean for frequency of water shortage

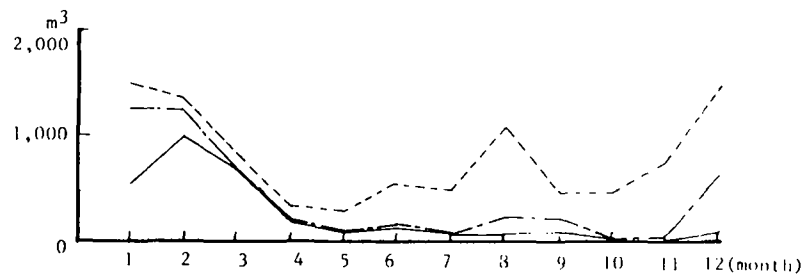

Figure 7.2. Monthly mean for volume of water shortage

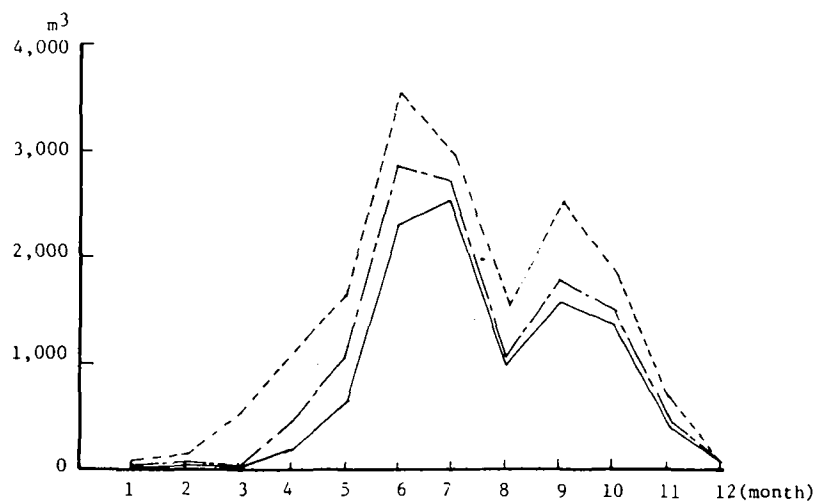

Figure 7.3. Monthly mean for volume of overflow

From these tables and figures, we find that the winter season has a high frequency of water shortages. On the other hand, because there is more rain water available during the summer months of June through September and particularly during the second third of June to the first third of July, the frequency of water shortage is low. At the same time, however, the overflow volume is large. The lowest reliability of water supply in the summer season was 49.3% for case 1 and 64.8% for cases 2 and 3.

In our analysis of the feasibility for the following cases, the initial loss  $l_0$  was 2.0 mm for all cases.

Case	Roof Catchment, $A$ (m <sup>2</sup> )	Water Supply to Buildings	Water Demand, $q$ (m <sup>3</sup> /day)	Storage Tank Capacity, $V$ (m <sup>3</sup> )		
4	35 662	A, D, F, I	202.3	4-(1) 2 023	4-(2) 6 069	4-(3) 10 115
5	35 662	A, D, F-L	370.9	5-(1) 3 709	5-(2) 11 127	5-(3) 18 545
6	35 662	All bldgs.	423.2	6-(1) 4 232	6-(2) 12 696	6-(3) 21 160
7	85 400*	All bldgs.	423.2	7-(1) 4 232	7-(2) 12 696	7-(3) 21 160
8	106 939†	All bldgs.	423.2	8-(1) 4 232	8-(2) 12 696	8-(3) 21 160

NOTE: -(1) is  $V/q = 10$  days; -(2),  $V/q = 30$  days; -(3)  $V/q = 50$  days.

\*Roof catchment, all buildings.

†Roof catchment (all buildings) + 14% open space.

Figures 8 and 9 show respectively the yearly mean of occurrence probability of water shortage and overflow. The curves were approximately drawn based on all cases of simulation.

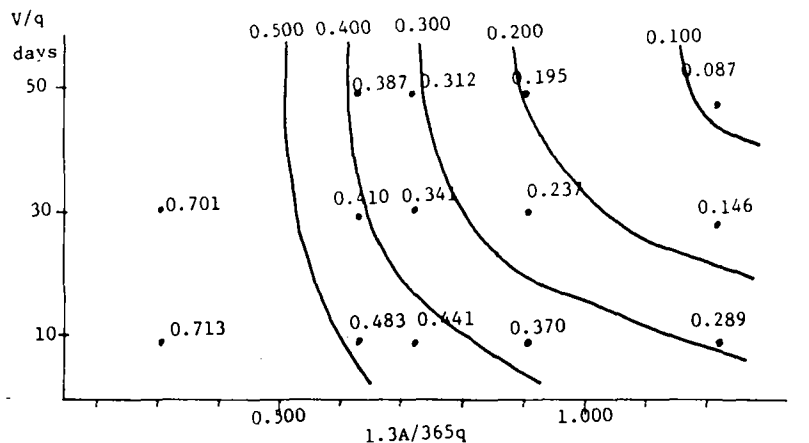

Figure 8. Yearly mean of occurrence probability of water shortage



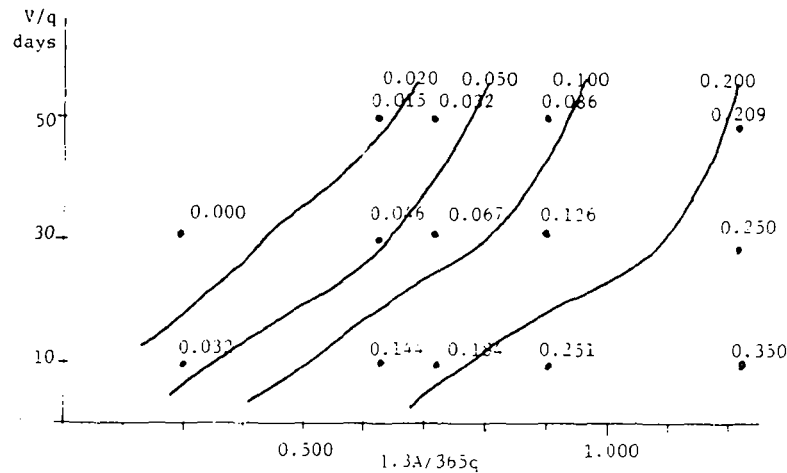

Figure 9. Yearly mean of overflow occurrence probability

Given the roof catchment area  $A$ , the storage tank capacity  $V$ , and water demand  $q$ , the reliability of water supply or the possibility of overflow can be estimated from these curves. Although only the yearly mean of reliability and possibility are presented in this paper, we can find their monthly or seasonal variation from simulation results.

#### FEASIBILITY ANALYSIS FROM THE WATER QUALITY POINT OF VIEW

To check the water quality of the rain water cistern system designed in the previous section, some water quality parameters were measured for the rain-fall itself and the collected water from roof catchment. The water quality parameters were measured twice: in time (rain no. 1, total rain volume = 1 mm; rain no. 2, total rain volume = 17 mm), and at two site locations (N, at outlet of north roof site; S, at outlet of south roof site) (Figure 10).

From these measurements, we were able to determine the adequacy of the water collected by the rain water cistern system in relation to the amount of water needed without treatment for flush toilets.

The construction cost for the cistern system discussed in this paper were roughly estimated (Table 5). We have not attempted here to discuss the economical feasibility of a cistern system based on the cost data, or to compare it with wastewater reuse system planned as an alternative source for urban water supply.

TABLE 5. RAIN WATER CISTERN SYSTEM CONSTRUCTION COST

	TANK CAPACITY ( $m^3$ )		
	1 000	3 000	5 000
	Construction Cost (million ¥)		
Collecting conduit	270.3	270.3	270.3
Storage tank	47.0	97.2	145.4
Distribution system (within building)	63.2	63.2	63.2
<b>Total</b>	<b>380.5</b>	<b>430.7</b>	<b>478.9</b>

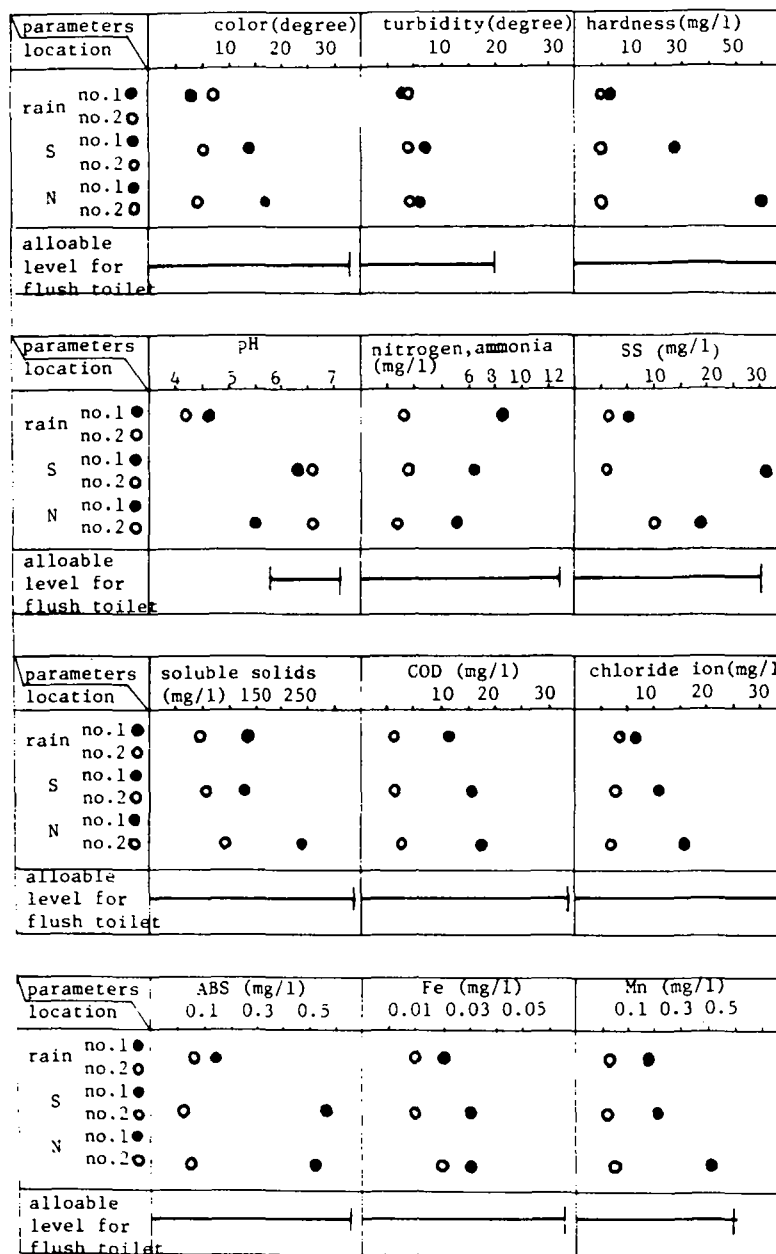

Figure 10. Measurements of parameters for water quality

## CONCLUSIONS

The design and development of rain water cistern system were analyzed from the hydrological and water quality points of view. As applied to the case study area in Japan, the following conclusions are presented:

1. A reliable and adequate water supply is possible with combinations of rain water catchment on roofs and storage tank capacity
2. Rain water collection from roofs can be utilized with simple or without treatment for flush toilets.

## ACKNOWLEDGMENT

The authors wish to thank the manager and engineers affiliated with the integrated dam control center of Yodo River, Ministry of Construction, who through their financial support and work have contributed to the production of this paper.

DETERMINING THE DESIRABLE STORAGE VOLUME  
OF A RAIN-CATCHMENT CISTERN SYSTEM:  
A STOCHASTIC ASSESSMENT

PingSun Leung, Assistant Professor  
Department of Agricultural and Resource Economics  
University of Hawaii at Manoa  
Honolulu, Hawaii 96822, USA

and

Yu-Si Fok, Professor  
Department of Civil Engineering  
University of Hawaii at Manoa  
Honolulu, Hawaii 96822, USA

INTRODUCTION

The four major design factors for rain-catchment cistern systems are rainfall, catchment area, storage capacity and water demand. Of these, only rainfall is uncontrollable by the system designer. In most cases, the size of the catchment area or roof is largely predetermined for an existing structure. The initial basic decision for the cistern owner is to determine the minimum storage capacity which can satisfy the water demand. The minimum storage capacity can be easily determined if given a set of deterministic rainfall for a fixed planning horizon. Most studies (Fok et al. 1980; Wentworth 1959) used the worst rainfall occurrence for the design of the storage capacity without looking into the impact of the stochastic nature of rainfall on storage capacity design. The present study suggests using computer simulation to determine the probability distribution of the minimum storage capacity required. This will provide additional information to the cistern owner in deciding on the necessary storage capacity. The historical rainfall pattern at the Manoa Tunnel station on the island of Oahu was analyzed and used as a case study.

MINIMUM STORAGE CAPACITY: A DETERMINISTIC MODEL. The sequence of events of a rain-catchment cistern system can simply be described as follows:

Rain falling on a catchment area enters the storage tank for a specific time interval. If the capacity of the storage tank is exceeded, water overflows and is wasted. Then water is withdrawn to satisfy the water demand up to the amount available in the tank for that time interval. Any water left in the tank will be carried over to the next time interval.

The above is referred to as the Yield-After-Spillage model which will slightly underestimate system performance for a long time interval. A time interval of one month was adopted in this study primarily to cut down the amount of calculations involved. It has been shown that results obtained using a one-month interval were comparable to that obtained with a one-day interval in California (Jenkins and Pearson 1978).

If rainfall is deterministic, the problem is to determine the smallest storage capacity that permits the projected demands to be satisfied for a planning horizon of T periods. This can easily be obtained by solving the following linear program:

$$\text{minimize } V \quad (1.1)$$

$$\text{s/t } S_t = S_{t-1} + I_t - D_t \quad \text{for all } t \quad (1.2)$$

$$D_t \leq S_{t-1} + I_t \leq V \quad \text{for all } t \quad (1.3)$$

$$S_t \geq K \quad \text{for all } t \quad (1.4)$$

$$S_t, I_t, D_t, V, K \geq 0 \quad \text{for all } t \quad (1.5)$$

where  $V$  = minimum storage capacity to be determined

$S_t$  = the quantity of water in storage at the end of period  $t$

$I_t$  = the quantity of inflow into storage during time period  $t$   
 ( $I_t = R_t A$  where  $R_t$  is the rainfall for time period  $t$  and  
 $A$  is the catchment area which is assumed to be fixed)

$D_t$  = demand of water for time period  $t$

$K$  = minimum storage volume to prevent an empty cistern.

It should be noted that the above linear program assumes that the catchment area and the demand pattern are fixed. The model can be easily modified to incorporate minimum and maximum demand levels as in most reservoir management models (Sobel 1975). Constraint (1.2) is the usual expression of storage continuity. The second constraint (1.3) states that demand has to be met and amount of water in storage cannot exceed the capacity. This constraint automatically forces the minimum capacity to be at least as large as the demand. Constraint (1.4) assumes that the tank would have a minimum amount of water all the time.

This model is identical in nature to the "minimax capacity problem" commonly employed by reservoir management research. It has also been shown that a very simple algorithm also leads to the solution of the linear program (Sobel 1975). A simplified version is adopted here for the cistern problem. This algorithm is used later to simulate many different random rainfall patterns which would otherwise require the costly solutions of a large number of linear programs. This simple algorithm is summarized here. Let  $L_t$  denote the sum of the minimum storage requirement  $K$  and water required to be held back in period  $t$  for future use. If demand  $D_t$  is greater than  $(S_{t-1} + I_t - L_t)$  in period  $t$ , this would lead to infeasibility in some period  $\tau > t$ . The following calculations are performed for a planning period:

$$L_T = K, M_T = K + D_T \quad (2.1)$$

$$L_t = K + (L_{t+1} + D_{t+1} - I_{t+1} - K)^+ \quad \text{for } t = 1, \dots, T-1 \quad (2.2)$$

$$M_t = L_t + D_t \quad \text{for } t = 1, \dots, T-1 \quad (2.3)$$

where  $(L_{t+1} + D_{t+1} - I_{t+1} - K)^+ - I_{t+1} - K, 0\}$  denotes the maximum of  $\{L_{t+1} + D_{t+1} - I_{t+1} - K, 0\}$ .

Equations (2.2) and (2.3) can be evaluated starting from  $t = T - 1$ . Then the minimal capacity of the minimax capacity is  $V = \max \{M_1, M_2, \dots, M_T\}$ .

Table 1 presents an example using the above simple algorithm to determine the minimax capacity for a 24-month planning period with constant monthly demands.

TABLE 1. EXAMPLE OF CISTERN MINIMAX CAPACITY PROBLEM

$D_t = 9,000$ for all $t$ , $K = 500$			
Month $t$	Inflow $I_t$	Computations	
		$L_t$	$M_t$
1	7,499	500	9,500
2	11,715	500	9,500
3	29,295	500	9,500
4	16,072	5,800	14,800*
5	5,039	2,339	11,339
6	9,686	3,526	12,526
7	5,473	500	9,500
8	21,967	1,050	10,050
9	7,949	500	9,500
10	13,005	500	9,500
11	41,372	500	9,500
12	11,771	500	9,500
13	25,045	500	9,500
14	10,368	500	9,500
15	28,890	500	9,500
16	13,868	500	9,500
17	12,498	500	9,500
18	11,817	500	9,500
19	24,547	500	9,500
20	24,768	4,182	13,182
21	4,817	500	9,500
22	9,268	500	9,500
23	14,749	2,271	11,271
24	6,728	500	9,500

\*Minimal Capacity  $V = 14,800$ .

A STOCHASTIC ASSESSMENT OF THE MINIMAX CAPACITY: A CASE ANALYSIS. The above procedure can only provide the minimal cistern volume for a deterministic set of rainfall pattern. However, rainfall is stochastic and its impact on the cistern volume design has to be evaluated. Since the above algorithm is very simple and can be quickly solved using a computer, a large number of

simulated rainfall series can be evaluated. This can provide a probability distribution of the minimax capacity volume of the cistern and hence would enhance the decision making process of the cistern owner.

A case analysis was done using the Manoa Tunnel station's monthly recorded rainfall. The average annual rainfall for Manoa Tunnel is 3,647 mm (143.58 in.) based on the 20 years of records (1953-1972). The average monthly rainfall ranges from 206 mm (8.1 in.) to 384 mm (15.1 in.) as shown in Figure 1. The minimum and maximum monthly rainfall for the 20-year period are also shown in Figure 1. Komologorov-Smirnov goodness-of-fit tests indicate that there is no significant difference at the 5 percent level between the distribution of the data for each of the months and the normal distribution (Table 2).

TABLE 2. VALUES OF KOMOLOGOROV-SMIRNOV D-STATISTICS FOR GOODNESS-OF-FIT OF MONTHLY RAINFALL DISTRIBUTION TO NORMALITY AT MANOA TUNNEL STATION

	Jan.	Feb.	Mar.	Apr.	May	June
	0.159	0.153	0.175	0.105	0.177	0.120
D-Statistics						
	July	Aug.	Sept.	Oct.	Nov.	Dec.
	0.179	0.191	0.118	0.130	0.171	0.151

Since the major purpose of storage is for meeting short or long deficiencies of rainfall, the inclusion of the serial correlation effect is important in the simulation of rainfall. The lag one correlation model was adopted for the generation of synthetic monthly rainfall for the following analysis. The lag one serial correlation coefficient was found to be 0.18 from the 20-year records. The following expression was used to simulate the rainfall sequence:

$$R_i = \bar{R}_i + 0.18 (R_{i-1} - \bar{R}_{i-1}) + Z\sigma_i(1 - 0.18^2)^{0.5} \quad (3)$$

where  $R_i$  = generated rainfall for month  $i$

$\bar{R}_i$  = mean of observed rainfall for month  $i$

$Z$  = unit normal random deviate

$\sigma_i$  = standard deviation of observed rainfall for month  $i$ .

Two hundred 24-month sequences of rainfall were generated using the above process. A roof area of 200 m<sup>2</sup> (2 150 ft<sup>2</sup>) and a uniform water demand of 34 m<sup>3</sup> (9,000 gal) per month were assumed for the case analysis. In addition, the minimum storage  $K$  was assumed to be 1.89 m<sup>3</sup> (500 gal). A minimax capacity was found using these parameters together with each of the generated rainfall sequence. The probability mass function and the cumulative distribution function of the simulated minimax capacity are respectively shown in Figures 2 and 3. From Figure 3, it can be seen that a 64.26-m<sup>3</sup> (17,000-gal) tank would be sufficient to cover the water requirements 80 percent of the time out of the 200 24-month sequences of generated rainfall. It should be noted that

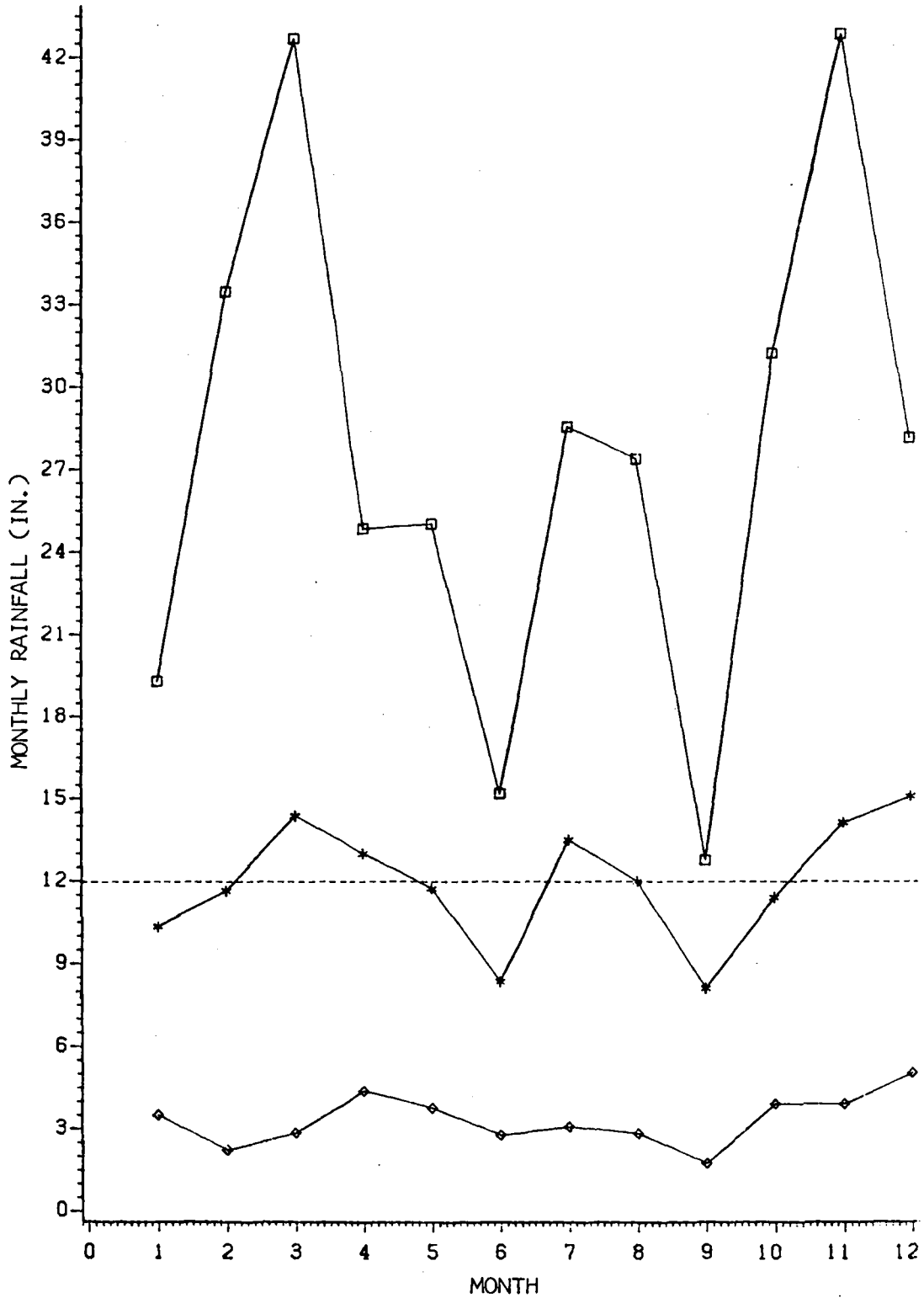

Figure 1. Mean, minimum and maximum monthly rainfall at Manoa, O'ahu



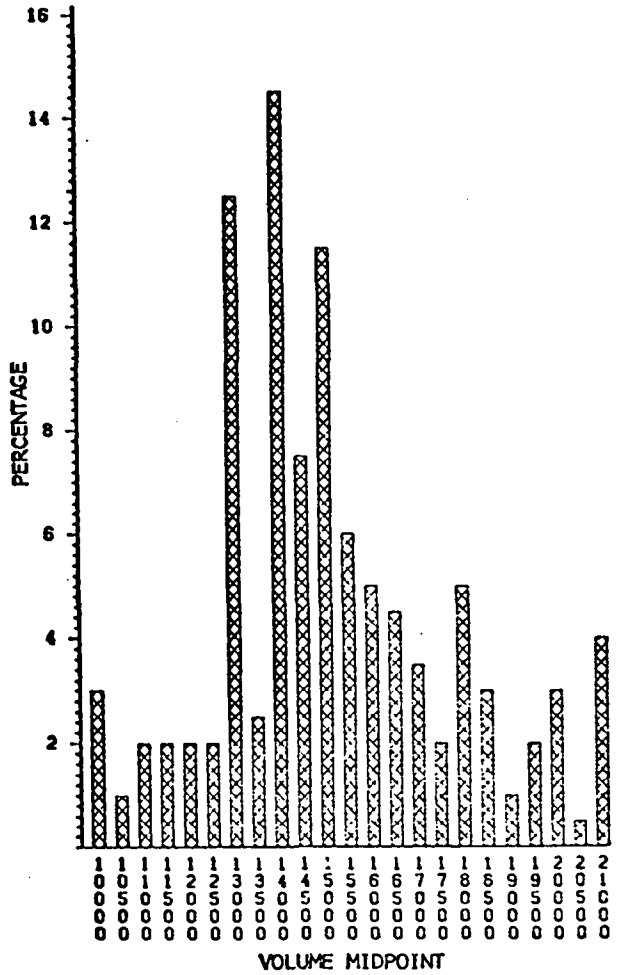

Figure 2. Distribution of minimax volume

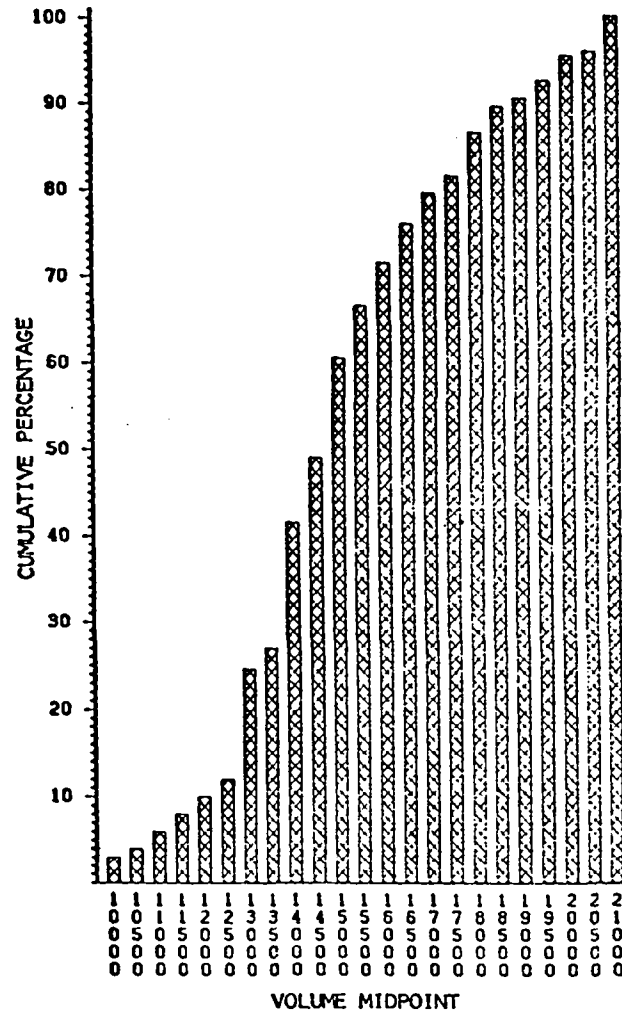

Figure 3. Cumulative distribution of minimax volume

these 200 sequences of rainfall represent 400 years of synthetic rainfall which the authors feel would be more than sufficient for the present analysis. It should also be mentioned that only a minimal amount of computer time is required to perform the above simulation analysis. However, it would add valuable information to the cistern owner's decision making process.

DISCUSSION. The above analysis focuses entirely on the determination of the minimally sufficient cistern capacity which is adequate if there are no alternate means of obtaining water. However, if the cistern owners have the option of getting water from other sources, it would be necessary to look into the economic tradeoff between the various cistern capacity levels and their associated water deficits. For example, cistern owners can pay a price to haul water by water truck if a deficit occurs. In that case, the optimal size of the cistern would be the volume that minimizes the total cost, comprising of the cost of the cistern and the cost of deficit. One possible formulation of total cost would be

$$TC = C_v V + C_d D$$

where  $C_v$  = annual level cost per unit volume of cistern

$V$  = cistern volume

$C_d$  = per unit cost of deficit

$D$  = expected annual deficit

Since deficit  $D$  depends on the size of the cistern  $V$  and the rainfall pattern which is stochastic, it would be necessary to find the associated deficits with a certain volume under various rainfall conditions. Computer simulation can be used to find the distribution of deficits associated with various sizes of the cistern. Then a relationship between the volume and the expected deficits can be established and, hence, the optimal volume can be located. However, this would require rather extensive simulations.

#### REFERENCES

- Fok, Y.S.; Fong, R.H.L.; Hung, J.; Murabayashi, E.T.; and Lo, A. 1980. Bayes-Markov analysis for rain-catchment cisterns. Tech. Rep. No. 133, Water Resources Research Center, University of Hawaii, viii + 100 p.
- Jenkins, D. and Pearson, F. 1978. Feasibility of rainwater collection systems in California. Contrib. No. 173, California Water Resources Center, University of California, Berkeley.
- Sobel, M.J. 1975. Reservoir management models. In Water Resources Research, 2(6):767-776.
- Wentworth, C.K. 1959. Rainfall, ranks, catchment and family use of water. Rep. R13, Hawaii Water Authority, Honolulu, Hawaii.

## OPTIMAL CATCHMENT DESIGN BY MARGINAL ANALYSIS

Richard J. Heggen  
 Assistant Professor of Civil Engineering  
 The University of New Mexico  
 Albuquerque, New Mexico 87131, USA

## RAINWATER CATCHMENT DESIGN

In many regions, roofing and cisterns provide a simple hygienic household water supply (Black and Popkin 1967; Bonilla 1967; Gillis 1967; McJunkin 1969; Ree 1976; Roberts 1967; Wagner 1959; Watson 1915, pp. 278-279; Watt 1978; USPHS 1962). An optimal allocation of resources for construction of such household rainwater catchment systems may be determined from basic engineering principles. Computer simulation may be used to investigate the effect of alternative combinations of rainfall, catchment area, storage volume, and water use rate on the adequacy of supply. Marginal economic analysis may be used to find that scale of facilities maximizing net benefits. Optimal system design includes: (1) precipitation synthesis, (2) water deficit calculations, (3) isodeficit curve construction, (4) isoquant analysis, and (5) optimal scale identification.

**PRECIPITATION SYNTHESIS.** Precipitation synthesis is the process of generating enough rainfall data to study the suitability of alternative rainwater catchment designs. Synthesis is required if the recorded rainfall is of a length shorter than that which against it is desired to test a hypothetical catchment. If a long record of rainfall exists, synthetic data need not be generated and actual data should be used.

Data synthesis is in itself an involved statistical process (Fiering and Jackson 1971). A brief description of the data generation employed in this study is reported in Heggen (1980). A first order Markov process with periodicity was assumed, employing a gamma-distributed random element. An alternative synthesis procedure was non-rigorously developed in which a completely random sequence of dry durations and wet durations (successive days with measurable rainfall) was first generated and then wet days were assigned a random rainfall. This alternative procedure appears to be an appropriate approach for catchment studies where design effectiveness is more limited by long dry periods than by wet periods having minimal rainfall.

**WATER DEFICIT CALCULATIONS.** The calculation of water deficits is an iterative process that includes routing a record of rainfall through alternate scales of roof catchments and storage facilities, applying an operating rule for the systems, and calculating the supply deficit given a target demand. Assuming a pattern of precipitation,  $P$ , any horizontal catchment area,  $A$ , diverting intercepted rain water into an effective storage volume,  $V$ , will yield a quantity of impounded water available for consumption. Consider any target demand,  $T$ , unsatisfied by the system to be deficit,  $D$ . For the catchment system in any period,  $i$ , denote initial storage as  $Q_{i-1}$ , inflow as  $P_i A$ , release as  $R_i$ , and final storage as  $Q_i$ . The mathematical expression of continuity is

$$Q_{i-1} + P_i A - R_i = Q_i \quad (1)$$

Introducing  $O_i$  as nonnegative cistern overflow,

$$R_i = T - D_i + O_i \quad (2)$$

a catchment system operating rule may be stated as

$$Q_{i-1} + P_i A - T + D_i - O_i = Q_i \quad (3)$$

In the example design to follow, events are assumed to occur in the following order: (1) daily rainfall is collected; (2) collected rainfall in excess of storage capacity is allowed to overflow; (3) daily consumption is withdrawn, if available; and (4) deficit is incurred if target demand cannot be satisfied.

$$O_i = P_i A + Q_{i-1} - V, \quad P_i A + Q_{i-1} \geq V \quad (4)$$

This order of events yields a somewhat larger cumulative deficit than would result if daily consumption could be partially satisfied by cistern overflow. This operating rule is shown in Figures 1 and 2.

**ISODEFICIT CURVE CONSTRUCTION.** Having determined water deficits, the effects of system scale on deficit may now be explored by computer simulation. Incrementally varying cistern volume,  $V$ , and catchment area,  $A$ , while target,  $T$ , is fixed, and determining annual deficit  $\bar{D}_a$  at each scale  $(V, A)$ , one may construct a family of isodeficit curves (isoquants of constant deficit).  $\bar{D}_a$  represents the response of the system to  $P$ . Figure 3 illustrates a family of isodeficit curves. Note that along any single curve, the same deficit is obtained with a large  $A$  and small  $V$ , a large  $V$  and small  $A$ , and intermediate combinations of  $A$  and  $V$  on the curve.

**ISOQUANT ANALYSIS.** Having defined the family of isoquants, the problem is now to allocate budget,  $M$ , between catchment area,  $A$ , and cistern volume  $V$ , so as to minimize deficits. Assigning annualized unit costs,  $C_A$  and  $C_V$ , to area and volume, the total investment for any catchment system is

$$M = C_A A + C_V V \quad (5)$$

This is a linear expression which can be plotted on the graph of isodeficit curves as shown in Figure 3. The optimization problem is to move along this budget line until the lowest isodeficit curve is encountered. This is the point of tangency  $(V^*, A^*)$ . Noting that the slope of the budget line is the negative unit price ratio of storage volume to catchment area  $(-C_V/C_A)$ , the optimal scale  $(V^*, A^*)$  is attained at the point on an isoquant where the marginal rate of substitution of area for volume is equal to this same price ratio.

By varying budget,  $M$ , an expansion path, or locus of points defining  $(V^*, A^*)$  as budget increases may be constructed. As shown in Figure 3, this path may be found by plotting several isodeficit curves and joining the points at which the slope of each equals the negative reciprocal ratio of the unit prices of  $A$  and  $V$ .

**OPTIMAL SCALE IDENTIFICATION.** If consumers cannot obtain target demand from their roof catchment, they will presumably make up deficits by getting water from other sources. The cost of tapping such sources to satisfy deficit

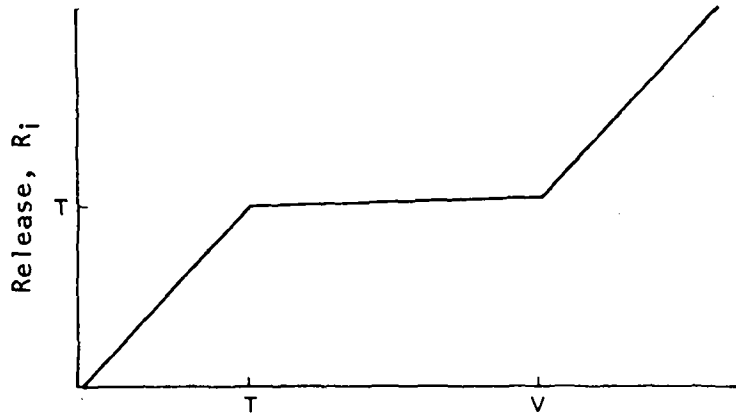

Inflow and Storage ( $P_i A + Q_{i-1}$ )

Figure 1. Operating rule

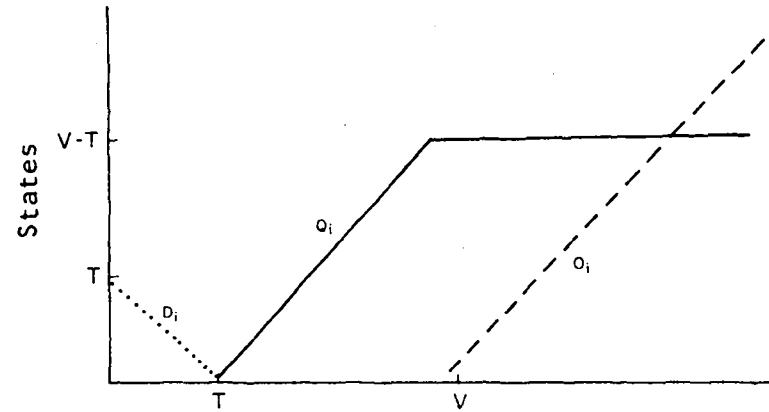

Inflow and Storage ( $P_i A + Q_{i-1}$ )

Figure 2. Transformed operating rule

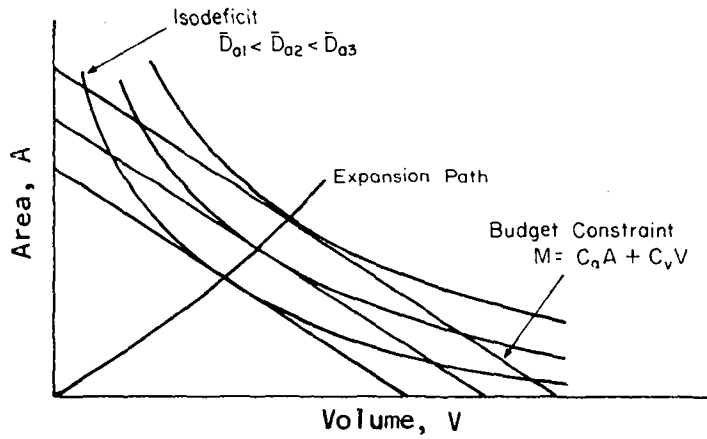

Figure 3. Expansion path

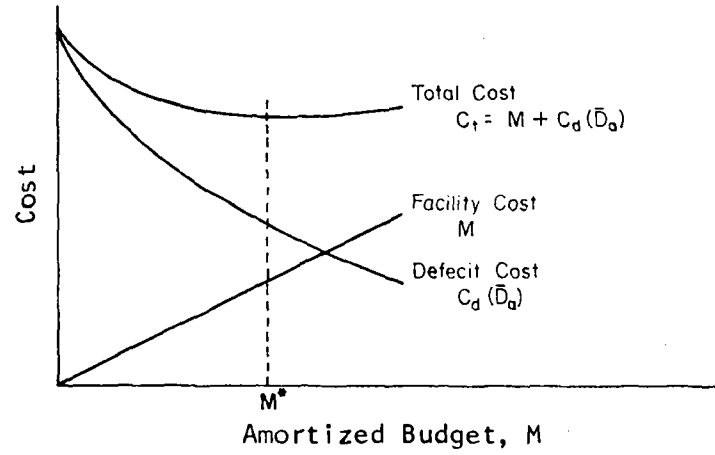

Figure 4. Total cost

is termed the penalty cost, and the cost per unit of deficit is the penalty price. The penalty cost is a measure of water supply benefits forgone.

The catchment system of optimal size will be of such scale that total costs are minimized, total costs comprised of catchment facility, cost,  $M$ , and deficit penalty,  $C_D(\bar{D}_a)$ , where  $C_D(\bar{D}_a)$  is the cost associated with an average annual deficit of  $\bar{D}_a$ . Total cost  $C_t$ , may be expressed as

$$C_t = M + C(\bar{D}_a) . \quad (6)$$

The total cost will be minimized when the marginal increase of investment  $M$  equals the marginal benefit of reduced deficit penalty,  $C_D(\bar{D}_a)$ . This is graphically expressed in Figure 4. The budget where total costs are minimized may be designated as  $M^*$ . The system scale ( $V^*$ ,  $A^*$ ) corresponding from isoquant analysis to this  $M^*$  represents the scale to which the catchment system should be built if the available funds are not exceeded.

#### A CASE STUDY

The Pacific Island of Kusaie ( $5^\circ\text{N}$ ,  $163^\circ\text{E}$ ) serves as a case study for an optimal catchment system evaluation. Kusaie is a large ( $109 \text{ km}^2$ ), underpopulated (3,266 in 1970) Eastern Caroline island of Micronesia (the Trust Territory of the Pacific Islands). Monthly rainfall varies from 30 to 60 cm with "droughts" (week long dry periods) occurring perhaps once or twice a year. Since occupation in World War II, climatological data have been recorded.

**WATER USE.** Kusaiens live along the shore in five villages. Only one of these sites is situated close enough to a fresh water river to assure its constant water supply. In other village areas, fresh water is more remote. Houses are generally constructed of planks and thatch. Almost all households use fuel drum containers to collect roof or tree runoff; simple improvements such as bamboo gutters often are not employed to increase the thatch. As perhaps two-thirds of the houses have thatch roofs, the roof runoff is polluted. This water is used for washing. Total water demand is approximately 40 liters pcd (per capita per day), here treated as a fixed, rather than dynamic, target (Lo and Fok 1980).

Only by canoeing along the reef and up estuary mouths is a satisfactory constant source of potable water found. Such trips are regular practice. Water provision for family cooking, washing, and to a lesser extent, bathing, can account to a great extent for at least one family member's productive capacity. Kusaie has five primary schools and a complete high school. Each youngster kept out of school to help with the daily chores deprives the island of another educated citizen in the future (Chan 1967).

**COST OF IMPROVED CATCHMENTS.** The cost of construction of a catchment system on Kusaie does not include a price for labor. Almost all housing construction projects are carried out by relatives at no salary expense to the owner. He, in turn, returns the favor. Home renovation is a regular occurrence, due in part to the temporary and cost-free nature of thatch and reed materials.

The two construction items incurring essentially all the cost of a catchment system are the imported metal roofing and storage cistern. Assuming

rafter slope, a discount rate and a negligible salvage value, an annual square meter price of horizontal rainwater catchment,  $C_A$ , results. Used, 210 liter fuel drums purchased from government surplus or passing ships are most commonly used as cisterns. Applying a capital recovery factor to the price of a drum, a yearly storage price,  $C_V$ , is determined.

**DEFICIT PENALTY.** Probably the more realistic penalty functions are stair-stepping upward penalty rates as deficit increases (White, Bradley and White 1972). Some benefit may or may not be attributed to surplus water. In the Kusaien study, a pair of simplified penalty functions is employed to price unsatisfied demands.

The first penalty function employed for unsatisfied target demand is based on an estimate of labor cost required to fetch the unsatisfied demand of water by foot or canoe. In the notation previously developed, deficit penalty may be calculated on a unit volumetric basis as

$$C_D(\bar{D}_a) = C_D \times \bar{D}_a , \quad (7)$$

where  $C_D$  is the unit penalty for deficit.

An alternative penalty function is determined by combining a unit price deficit penalty with a fixed price for deficit occurrence. The rationale for such a penalty function rests on economy of scale: many small deficits may require more labor to make up than do several large water shortages. Volumetric deficit penalties are taken to be less than those in the previous function. To this cost is added a fixed charge for each day on which target demand is not met by collected rainfall. A deficit day counter may be used to find  $\bar{N}_a$ , the average number of days in which some deficit occurs per year. Deficit penalty is now expressed as

$$C_D(\bar{D}_a) = C'_D \times \bar{D}_a + C_N \times \bar{N}_a , \quad (8)$$

where  $C'_D$  is a volumetric deficit cost and  $C_N$  is a charge per day in which deficit occurs.

**AN EXAMPLE DESIGN.** Simulation testing by routing five years of synthetic rainfall through a grid of catchment scales (V, A) gives average annual deficit evaluations needed to construct isodeficit contours. Figure 5 indicates the isoquant diagram resulting from the simulation when  $T = 40$  liters pcd. The expansion path passes through each isodeficit curve at that point where the isodeficit curve is tangent to a linear budget constraint.

A deficit penalty is applied; in this case consider unit deficit to be priced at \$0.005 per liter. Points along the expansion path are evaluated for total cost. Total cost is minimized at scale (145, 9.4) at which  $\bar{D}_a = 750$  liters/year. As deficit penalty increases, minimum total cost is found higher up the expansion path.

The expansion path for  $T = 40$  liters pcd with indication of minimum total cost at alternative deficit prices is transferred to Figure 6. Also transferred are expansion paths marked at points of minimum total cost as  $C_D$  varies for other targets. The points of minimum total cost for common penalty price are connected between the expansion paths.

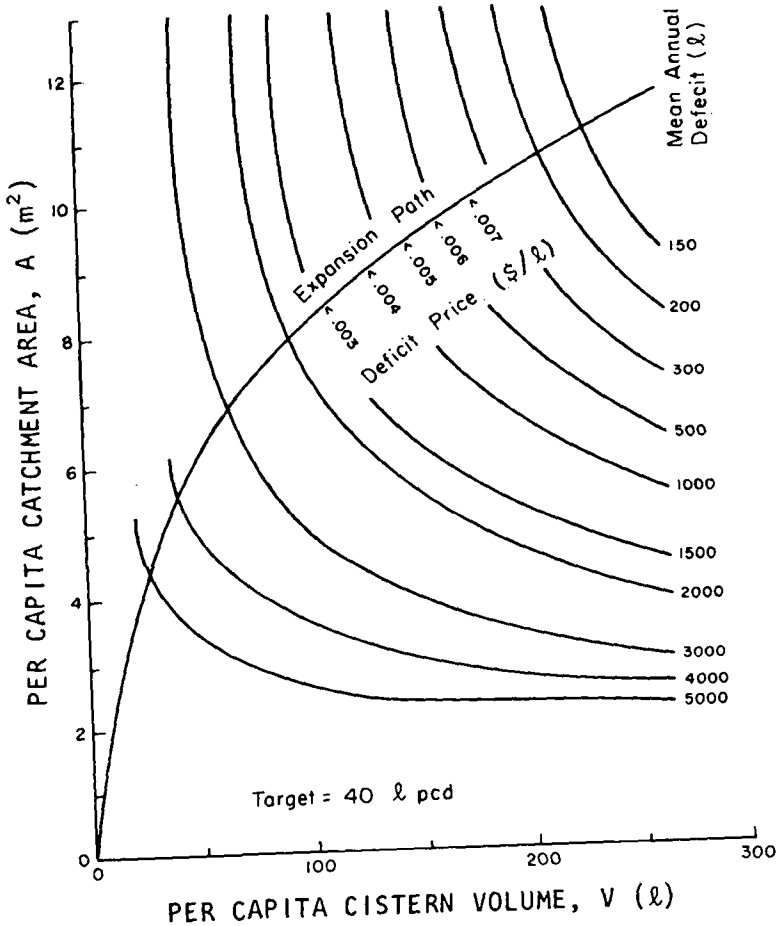

Figure 5. Expansion path

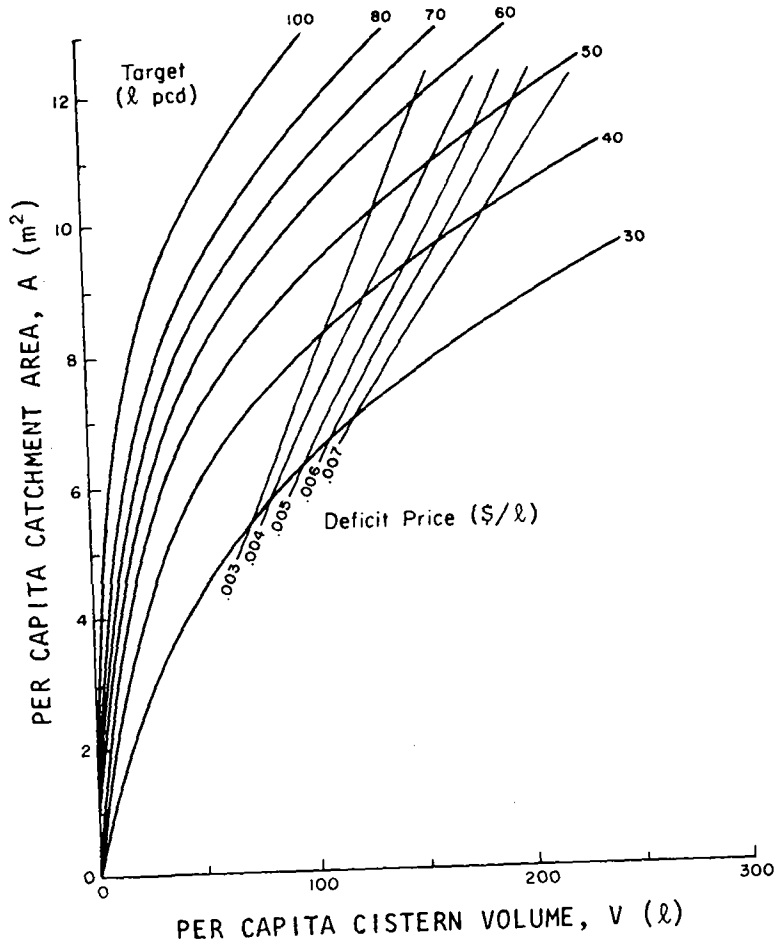

Figure 6. Sensitivity to price and target



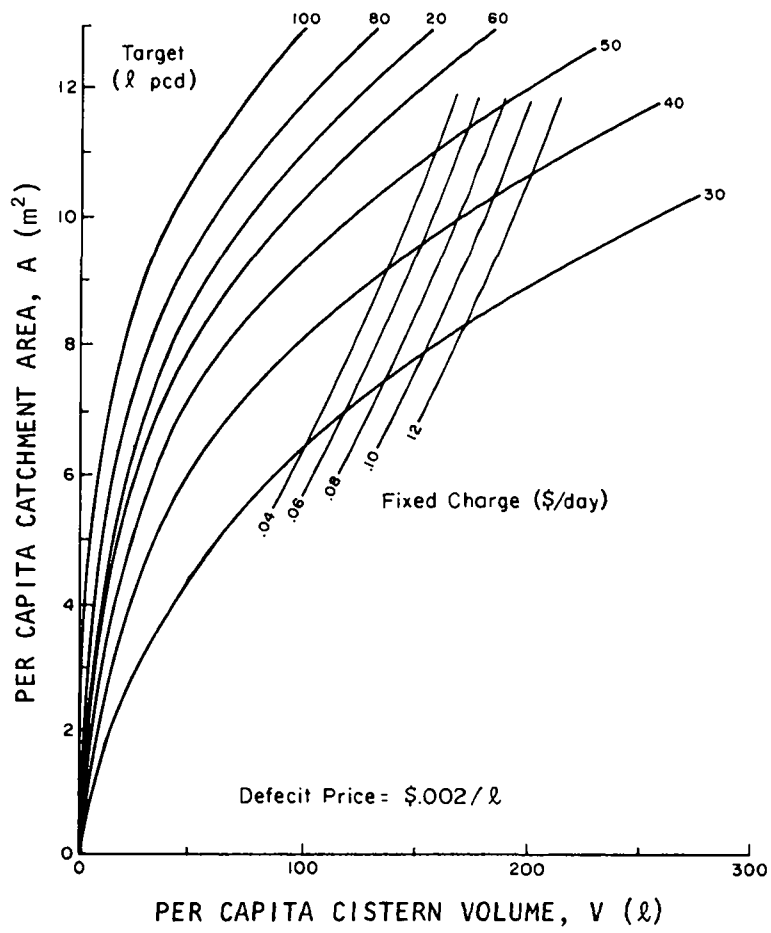

Figure 7. Sensitivity to price and target

If deficit penalty is also attributed to days in which some deficit does occur, the same family of expansion paths in Figure 6 may be analyzed with deficit penalty a function of both average annual deficit and days with deficit per year. Figure 7, one result of this analysis, indicates optimal system scale for a given  $C_D'$  and variable T and  $C_N$ . The optimum catchment of  $C_D' = \$0.002/\text{liter}$ ,  $C_N = \$0.10/\text{day}$  will deficit, and T = 40 liters pcd is of scale (180, 10.2).

DISCUSSION. In the example catchment design, the expansion paths show that the variable V is generally more elastic to expansion than is the variable A. If a catchment system is expanded in an optimal manner, the proportional change in V will be greater than the proportional change in A. As T and  $C_D$  are estimates, it is beneficial to explore the sensitivity of optimum scale to variation in these parameters. Generally, if target remains constant while deficit penalty varies, the response of V is more elastic than the response of A. On the other hand, if penalty price is constant while target varies, the response of A is more elastic than that of V.

As no constraints are placed on area or volume (except they be non-negative) in the formulation of this problem, optimal scales of each should be checked to see if they represent feasible values. Setting target demand at 40 liters pcd and penalty price as  $\$0.0028/\text{liter}$  of deficit (approximating assumed conditions), Figure 6 gives an optimal solution, an area of  $8.2 \text{ m}^2$ , and a volume of 108 liters. These values are plausible and are substantiated by the observation that households with this scale of catchment find themselves generally supplied with water on Kusaie.

TABLE 1. OPTIMAL CATCHMENT SCALE (VOLUME, AREA) FOR SELECTED PENALTY FUNCTIONS AND TARGET DEMANDS

PENALTY FUNCTION		PER CAPITA TARGET DEMAND			
Deficit Price \$/ℓ	Fixed Charge \$/day	40 liters		60 liters	
		System Scale		System Scale	
		V ℓ	A $\text{m}^2$	V ℓ	A $\text{m}^2$
0.0028	0.00	108	8.2	150	11.7
0.0056	0.00	139	9.2	206	13.3
0.0014	0.04	116	8.5	150	11.8
0.0014	0.08	153	9.5	192	12.7
0.0021	0.04	139	9.2	186	12.7
0.0021	0.08	173	9.8	218	13.5
0.0028	0.04	161	9.7	212	13.4
0.0028	0.08	192	10.3	243	14.1
0.0035	0.04	167	9.8	232	13.9
0.0035	0.08	201	10.5	266	14.8

Eight square meters of catchment per person can be attained in most instances by metal roofing on the family living quarters, boathouse, and/or copra drying house. The storage represents about half of a fuel drum per person. Table 1 indicates systems scales for selected penalties and targets.

The results of this study confirm that rain water catchment of water supply can be appropriate for Kusaie Island. Moreover, the results demonstrate that catchment sizing should vary with changes in water requirements or water value. The results indicate suggested catchment dimensions and reveal in what manner progressive development might be efficiently made.

## REFERENCES

- Black, J.F., and Popkin, A.H. 1967. Low-cost water from asphalt catchments. In Water for Peace, International Conference on Water for Peace, pp. 729-739. Washington: Government Publications Office.
- Bonilla, L.C. 1967. 20 años de lucha contra la sed en el medio rural Venezolano. In Water for Peace, International Conference on Water for Peace, pp. 897-909. Washington: Government Publications Office.
- Chan, G.L. 1967. Water supply problems of coral atolls. In Water for Peace, International Conference on Water for Peace, pp. 929-934. Washington: Government Publications Office.
- Fiering, M.B., and Jackson, B.B. 1971. Synthetic streamflows. Washington: American Geophysical Union.
- Gillis, L. 1967. Country situation reports, British Crown Colony of Fiji. In Water for Peace, International Conference on Water for Peace, pp. 262-273. Washington: Government Publications Office.
- Heggen, J.J. 1980. Design of rainwater catchments: A systems approach. In Necesidades Basicas y la Tecnologia, pp. 471-490. El Salvador: UCA.
- Lo, A., and Fok, Y.S. 1980. Application of a single-reservoir operation policy to a rainwater catchment system. University of Hawaii.
- McJunkin, F.E. 1969. Community water supply in developing countries: A quarter-century of United States assistance. Washington: AID.
- Ree, W.O. 1976. Rooftop runoff for water supply. ARS-S-133. Washington: U.S. Department of agriculture.
- Roberts, W.J. 1967. A fabricated floating catchment for water supply. In Water for Peace, International Conference on Water for Peace, pp. 647-650. Washington: Government Publications Office.
- U.S. Public Health Service. 1962. Surface water for rural use. In Manual of Individual Water Supply Systems, PHS Publication No. 24, pp. 53-63. Washington: Government Publications Office.
- Wagner, E.G., and Lanoix, J.N. 1959. Water supply for rural areas and small communities. Monograph Series No. 42. Geneva: World Health Organization.
- Watson, M. 1915. Rural sanitation in the Tropics. London: Murray.
- Watt, S. 1978. Rainwater storage tanks in Thailand. Appropriate Technology 2(5):16-17.
- White, G.F.; Bradley, D.J.; and White, A.U. 1972. Drawers of water: Domestic water use in East Africa. Chicago: University of Chicago Press.

## APPLICATION OF GOULD MATRIX TECHNIQUE TO ROOF WATER STORAGE

Terry L. Piggott, Senior Lecturer  
Department of Civil Engineering  
Queensland Institute of Technology  
Brisbane, Queensland, AUSTRALIA

Ian J. Schiefelbein, Engineer  
Gutteridge, Haskins & Davey  
Brisbane, Queensland, AUSTRALIA

Mark T. Durham, Engineer  
Telecom, Australia  
Brisbane, Queensland, AUSTRALIA

## INTRODUCTION

The dependence of many Australian homes on roof and tank rainwater collection systems has been discussed in detail by Perrens (1975). Perrens used a monthly simulation model to relate roof area, storage capacity and demand to probability of failure at Armidale in New South Wales. He drew economic comparisons between extending the system capacity and buying water when the system failed to meet the required demand.

Durham (1980) and Schiefelbein (1981) used the Gould matrix technique (McMahon and Mein 1978) to determine probabilities of failure of a roof-tank system, rather than to rely on critical period methods. These studies were initially made for Brisbane and subsequently for a number of selected climatic zones within Queensland as part of a continuing programme.

This paper covers some aspects of the work initiated by Durham (1980) and continued by Schiefelbein (1981).

## OUTLINE OF INVESTIGATION

The object of this study was to find the relationships between the roof area and tank capacity in order to meet a given demand with a certain level of reliability. Initially, the Brisbane region of Queensland was considered where some 110 years of daily rainfall records were available.

Brisbane, the capital of Queensland, is situated on the East Coast of Australia at latitude 27°28'. The climate is characterized by a mild, dry winter and a hot, wet summer.

Monthly mean rainfalls range from 166 mm in February to 47 mm in August. The mean annual rainfall is 1 138 mm with a range from 2 251 to 411 mm/yr.

A behaviour analysis, based on monthly rainfalls, was used to set up a transition matrix from which a steady state relationship between storage zone and probability could be found. Combining these with failure probabilities found from the behaviour analysis produced a probability of failure for a given roof area, tank storage and demand. The procedure was repeated for combinations of these variables.

## BEHAVIOUR ANALYSIS

SYSTEM INPUT. The monthly input to the tank using a runoff coefficient of 0.7 storage system was found from the following volumetric rational method:

$$MIV = \frac{0.7 \cdot AR \cdot MR}{1000} \quad (1)$$

where

MIV = monthly inflow volume, m<sup>3</sup>

AR = roof area, m<sup>2</sup>

MR = monthly rainfall, mm.

The use of a volumetric runoff coefficient of 0.7 follows Australian recommended practice (Dept. of Employment and Industrial Relations 1977; Commonwealth Experimental Building Station 1978). The reasons for a value of 0.7 are not clear, apart from the fact that it takes into account splashing and evaporation from roofs.

Roof areas in the range 100 to 600 m<sup>2</sup> were considered in the study.

STORAGE. Tank sizes, in the 5- to 40-m<sup>3</sup> range, were used in the investigation. Each capacity was considered to be divided into 30 zones of which zones 0 and 29 had zero volume and the other 28 zones equal volumes of SVI/28, where SVI = tank capacity in m<sup>3</sup>.

DEMAND. Perrens (1975) quoted the following per capita demands:

Rural	200 ℓ/day
Urban, Armidale	250 ℓ/day
Urban, Sydney	520 ℓ/day

In Queensland, per capita demands for urban water supply design are available from the Queensland Local Government Department (1975) standards:

S.E. Queensland	350 ℓ/day
North coast towns	700 ℓ/day
Western towns	900 ℓ/day (if made available).

Durham (1980) considered that people would use water at very high rates where it was available, but that they would tend to limit themselves when the supply is scarce. He reasoned that a per capita demand of 180 ℓ/day would be reasonable for rural Queensland. As a consequence, the study for Brisbane used demands of 360, 540 and 720 ℓ/day.

Two demand strategies were considered: first, constant demand and second, demand rationed in relation to the level of supply in the tank storage. Table 1 shows the rationing scheme.

TABLE 1. WATER RATIONING SCHEME

Storage Zone	% Unrationed Demand
20-29	100
15-19	87.5
10-14	75
5- 9	67.5
0- 4	50

## GOULD MATRIC METHOD

The Gould matrix method was discussed in detail by McMahon and Main (1978).

The procedure is a discrete time interval Moran model, which is modified by using behaviour analysis to allow for such effects as serial correlation and seasonality on the within-year inputs, and to give scope for variation in demand from month to month.

The probabilities associated with the storage being within each of the 30 zones at the end of a year are given by the 30 x 1 probability vector (p) in

$$[p]_n = [T][p]_{n-1} \quad (2)$$

where the subscripts n relates to the end of year n and n-1 to the end of year n-1, or the beginning of year n; and where [T] is a transition matrix (in this case 30 × 30) whose elements relate the probability of ending the year in a particular zone, conditional on starting the year in a given zone.

If equation (2) is repeated a number of times, the probability vector approaches a steady state. This steady state can be determined by

1. Raising the transition matrix to the power  $2^m$  where m is a positive integer chosen large enough to make the columns of the powered up matrix become equal to one another and equal to the steady state probability
2. Solving 29 of the 30 simultaneous equations at steady state,

$$[T][p] = [p] \quad (3)$$

and replacing the 30th by

$$\sum p = 1 . \quad (4)$$

In this study, an m value of 10 was used, which was probably unnecessarily high. Both methods of assessing steady state probability were used and found to give generally identical results.

TRANSITION MATRIX. The transition matrix was built up from the behaviour analysis. For each of the 110 years of record, the storage was assumed to

start in zone 0. For each month of each year, the storage zone at the end of each year was found from successive applications over the year of

$$STA_{t+1} = STA_t + MIV_t - MDV_t \quad (5)$$

$$STA_{t+1} \leq SVI \text{ (spill)} \quad (6)$$

$$STA_{t+1} \leq 0 \text{ (failure)} \quad (7)$$

where

STA = storage at end of month t, m<sup>3</sup>

MIV = monthly inflow volume, m<sup>3</sup>

MDV = monthly demand volume, m<sup>3</sup>

SVI = tank capacity, m<sup>3</sup>.

A tally sheet was drawn up with columns representing the storage zone at the start of each year and the rows the storage zone at the end of the year. Appropriate elements of both columns could be scored from the applications of equation (5). The probabilities of ending the year in a particular zone, given that the storage was in a certain zone at the start of the year, were found by dividing the tallies by the number of years of record considered NY, in this case 110.

The procedure was repeated with the storage starting in each of the other 29 zones and the resulting probabilities formed the transition matrix elements.

Transition matrices were found from various combinations of tank capacity SVI and the roof area AR; for monthly inflow and demand MDV.

The steady state probabilities were found by powering up the transition matrix and by solving the steady state equations.

**FAILURE PROBABILITY.** A separate tally sheet was kept and, for a given starting zone, the number of months a failure occurred scored. The probability of failure was found by dividing those scores by 12 NY, the number of months considered.

The failure probability, PF, associated with a particular combination of roof area, tank capacity and demand was found by multiplying corresponding elements of the steady state probability (the probability that storage will start the year in a particular zone) by the probability that supply will fail if the storage starts the year in that zone, and adding these products.

These probabilities represent the probability of failure in any one month. The equivalent annual exceedance probability was calculated from equation (8) and the corresponding return period by its reciprocal:

$$P_E = 12 \cdot PF \quad (8)$$

where

$P_E$  = failure probability, annual exceedance series

PF = probability of failure of a storage, roof and demand combination.

RESULTS

Figures 1 and 2 from Durham (1980) show a characteristic form similar to curves presented by Perrens (1975).

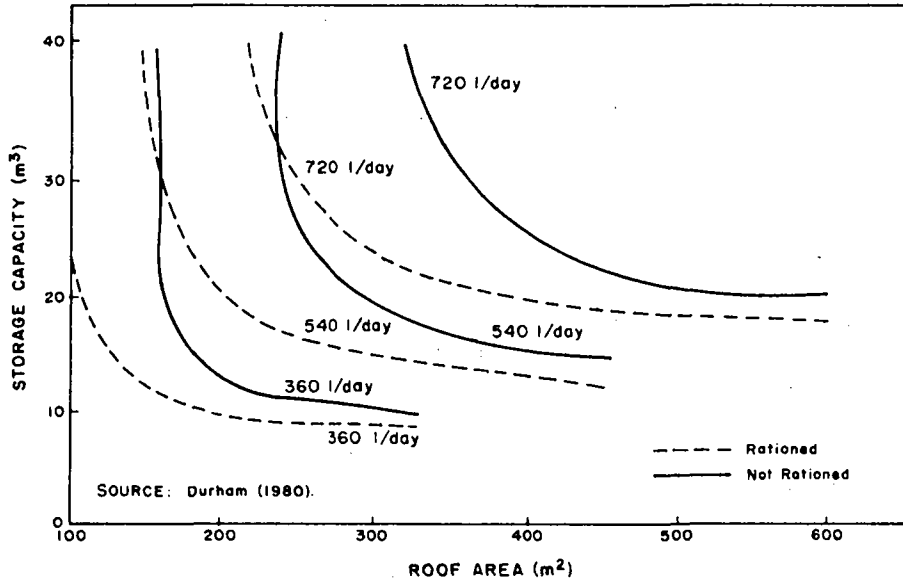

Figure 1. Design curves for an exceedance return period of one year

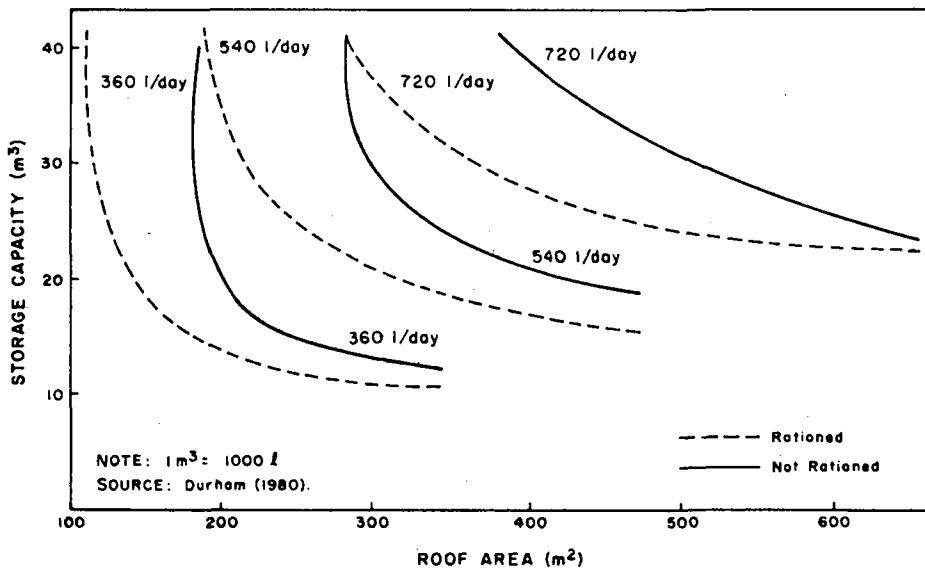

Figure 2. Design curves for an exceedance return period of five years



The shape of these curves reflects the influence of rationing policy on the minimum area required to meet a particular demand. These curves can be used for design purposes where a level of reliability, in this case the annual exceedance return period, is specified.

In extending Durham's 1980 work, Schiefelbein developed a log-probability plot (Fig. 3) as an aid in interpolating the failure probabilities produced by the Gould matrix technique

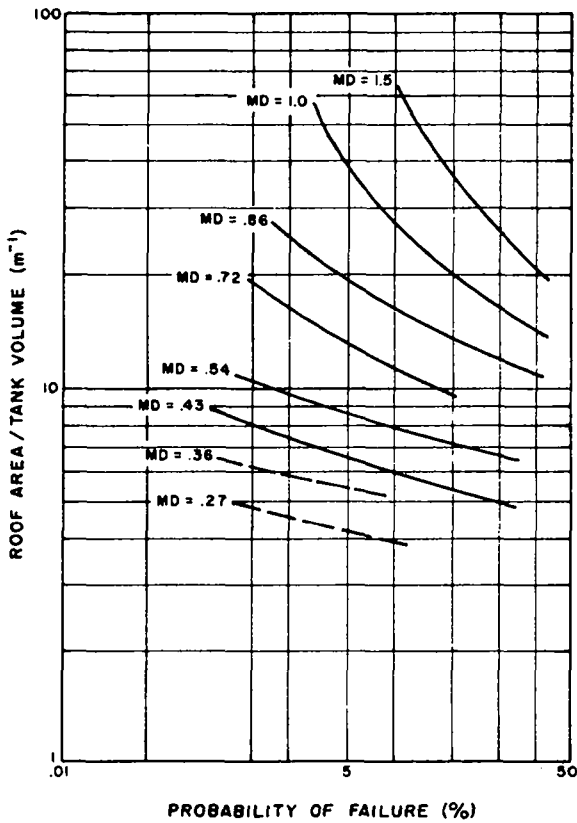

Figure 3. Log-probability interpolation diagram

The method reduced the number of variables to be graphed by dividing the monthly demand, in  $m^3$ , and the roof area by the storage value.

Figure 4 shows the rationalized design curves which were used as a basis for regional comparisons.

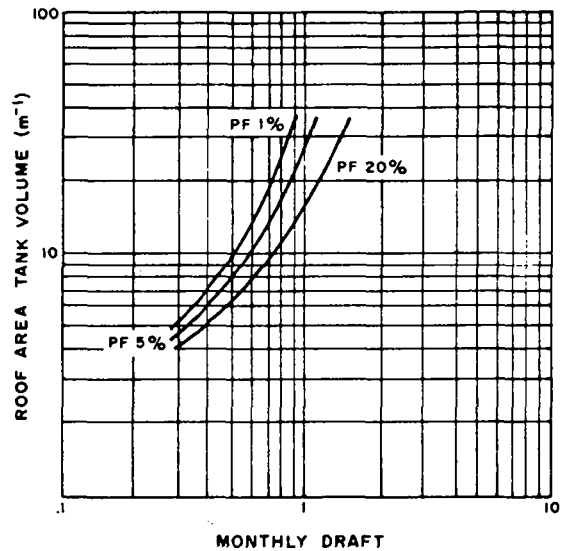

Figure 4. Rationalized design curves

### CONCLUSIONS

The results presented here are part of an on-going study which will hopefully cover some 20 climatic regions within Queensland.

The results from the Brisbane region study support the use of the Gould matrix technique for assessing the probability of failure of a given roof water, tank and demand system.

Data presentation for both design and comparison purposes can be accomplished by using the format of Figure 4.

There is scope for investigations into such areas as monthly rainfall-

runoff modelling from domestic roofs; assessing a design failure probability, based on regional consequences of storage failure; and rationing strategies, again on a regional basis.

No attempt has been made to compare the economics of buying water as opposed to capital investment in tank storage. Figure 4 does give a means of estimating change in the probability of failure for a given change in storage volume, but a model similar to Perren's (1975), where water is brought in when the system runs out of water, must be incorporated into the existing study for meaningful results. In a regional drought, where water purchase must be made, the buyer is a victim of the market place fluctuation of both cost and availability.

#### REFERENCES

- Commonwealth Experimental Building Station. 1978. Roof Drainage. Nos. 151 and 152, Notes on the Science of Building. Canberra: Australian Government Printing Service.
- Department of Employment and Industrial Relations. 1977. Water Supply, Basic Trade Manual No. 3, Publishing Service. Canberra: Australian Government.
- Department of Local Government, Queensland. 1975. Guidelines for Water Supply Planning. Brisbane, Queensland.
- Durham, M.T. 1980. "Domestic Storage Requirements for Farms." B. Eng. thesis, Department of Civil Engineering, Queensland Institute of Technology.
- McMahon, T.A., and Mein, R.G. 1978. Reservoir Capacity and Yield. Vol. 9, Developments in Water Science. Amsterdam: Elsevier.

## DESIGN AND CALCULATION OF RAINWATER COLLECTION SYSTEMS

C.L.P.M. Pompe, Engineer  
West Java Rural Watersupply Project 0-9(a)  
Postbox 59  
Bandung, INDONESIA

### INTRODUCTION

Dry seasons occur even in monsoon areas. If there are no nearby wells or rivers, people will walk long distances to obtain water. A solution to this problem may be the catchment of rain water—an ancient custom still practiced in many countries in the world where rainfall is collected during the wet season to use in the dry season. The questions are (1) what should the volume be of such a rainwater collection system and (2) how should such a collector be designed?

This paper deals mainly with the first question: the calculation of the volume of the rainwater collector.

H.M.C. Satijn (1979), who was a former project participant, analyzed the problem and designed a computer simulation model of the rainwater collection system. Because computers are not widely available, I was asked to review Satijn's work and to develop a slide rule-calculation method that could be used by regional technicians. Thus, a step-by-step method was designed to enable technicians to calculate the volume of rainwater collectors by using available monthly rainfall data.

The results of the calculation are not sacrosanct because, first of all, the variables of themselves vary widely, such as consumption or the water demand. Thus, if 5 l/person/day is the basis for calculating drinking water needs, there is no way of knowing the actual use and the variation in conservation and utilization. What must be borne in mind in the statistical calculation of rainwater catchment systems is that its accuracy will depend on correct input. It is also important to be realistic in using the statistical calculation method, rather than concentrating on complicated statistical computations.

The vital question is "Who pays?" If the farmer (user) pays, he will construct a 15-m<sup>3</sup> collector and in the dry season will be conservative in using his water while praying to Allah that rain will soon fall again. When the government or an international organization pays, the designer might think of future users and design a 20- or even 25-m<sup>3</sup> collector.

The basic principle of this method is the importance of calculating storage to provide enough water of the period of the year when there is no rainfall or when it is insufficient to meet water needs. In the following sections the step-by-step method and the theoretical background of the method are presented, and the last section includes some design criteria for the rainwater collection system.



- STEP 7. Determine Time Storage, TmS (mo)  
Determine the TmS value from the following:
- Number of rainfall data, 10: T10S (storage not sufficient once in 10 years) is equal to the highest value of TS; T20S is equal to  $1.1 \times$  highest value of TS
  - Number of rainfall data, 15: T10S = next to highest TS; T20S =  $1.1 \times$  next to highest TS
  - Number of rainfall data, 20: T10S =  $0.9 \times$  highest value of TS; T20S = highest value of TS

- STEP 8. Determine leakage, L  
L = 0.1 puddled clay-line reservoir  
L = 0.05 concrete-lined reservoir  
L = 0.01 ferrocement or steel reservoir

- STEP 9. Determine evaporation, E (m/mo)  
E = 0.1 m/mo for open reservoir (Indonesian conditions)  
E = 0.01 m/mo for ventilated, roofed reservoir  
E = 0.0 m/mo for closed reservoir

- STEP 10. Determine evaporation surface, S (m<sup>2</sup>)  
Calculate open water surface, S = .....

- STEP 11. Calculate storage volume, SV (m<sup>3</sup>)  
$$SV = \frac{(MC \cdot 10^{-3} + S \cdot E) \cdot TmS}{(1 - 0.5 \cdot L \cdot TmS)} = \frac{\dots\dots}{\dots\dots} = \dots\dots$$

MC = STEP 2 (l/mo); S = STEP 10 (m<sup>2</sup>); E = STEP 9 (m/mo); L = STEP 8; and TmS = STEP 7 (mo).

#### THEORETICAL BACKGROUND OF THE METHOD

The roof or any surface area on which rainfall is collected is called the catchment area. From this catchment area, the water is conveyed into the collector (Fig. 1). A filter is mostly used to treat the incoming water before it enters the collector to prevent pollution, and its capacity should be large enough that the inflow is not obstructed. The disadvantage of an open collector is evaporation; and in closed collectors, a certain amount of leakage outflow. Thus, outflow can consist of leakage and withdrawal for consumption.

During the wet season, there is both inflow and outflow; in the wet season, there is only outflow. In Indonesia, a certain part of the wet season is characterized by less inflow than outflow. Therefore, it is for this particular period that rainwater collectors would provide storage for surplus rain water.

This period of insufficient rainfall is determined by the rain, R; the constant runoff factor, ROF; and the catchment area, A, for the flow of water into the storage which can be expressed as

$$IN = ROF \times R \times A .$$

If the inflow exceeds the outflow (consumption, leakage and evaporation), then

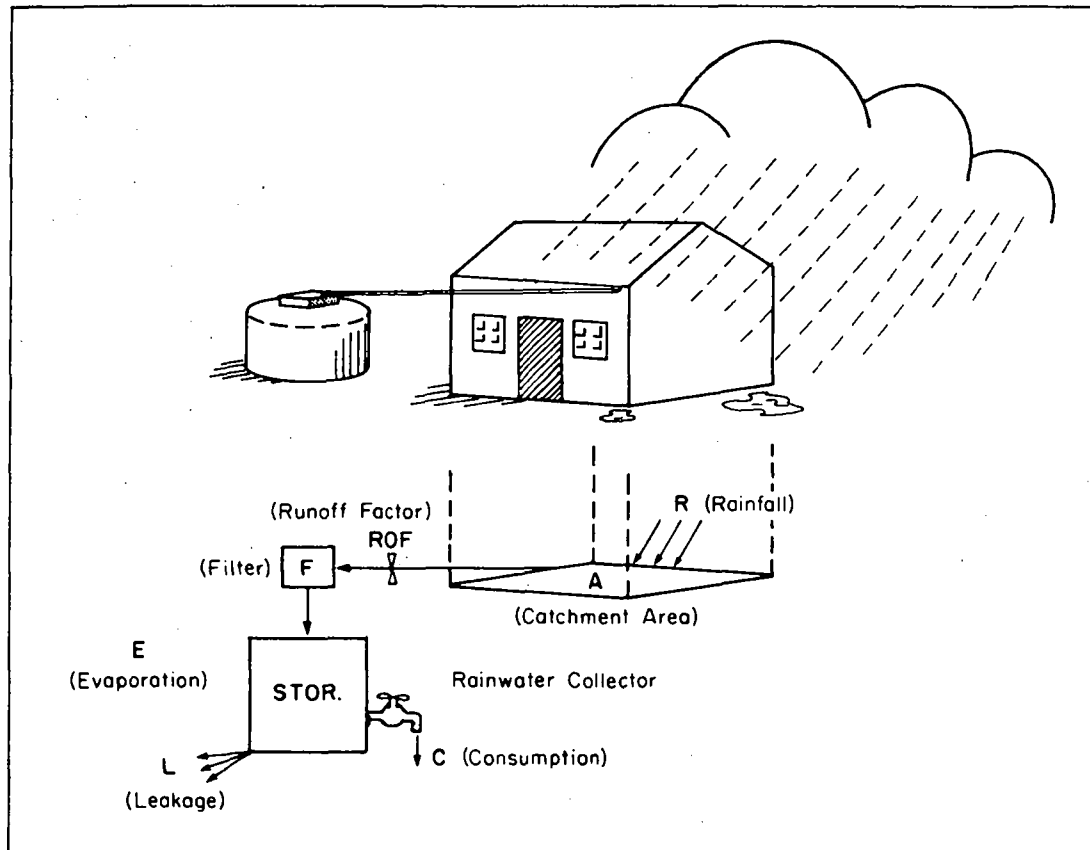

Figure 1. Rainwater collection system

the storage is charged or overflowing. When rainfall is insufficient, the inflow is less than the outflow. In the situation where the inflow equals the outflow, the critical rainfall, CRF, can be derived from

$$IN = ROF \cdot R \cdot A = ROF \cdot CRF \cdot A = OUT$$

which results in

$$CRF = \frac{OUT}{ROF \cdot A}$$

Thus, the year can be divided into periods with sufficient rainfall; the wet period, TW, and periods with insufficient rainfall; and the dry period, TD, and the insufficient rain period, TI. This division is schematically shown in Figure 2. It must be noted that this calculation method is based on the importance of the adequacy of storage to provide water in periods of insufficient and no rainfall.

**THEORETICAL BACKGROUND.** The length of the period in which the storage has to supply the outflow is determined by the rainfall data. These TS periods seem to follow cumulatively an exponential curve in the form,  $a \cdot e^{-bx}$  for the northern coastal plain of West Java, which is approximately  $1.2 \cdot e^{-0.38 \times TS}$ . However, to calculate the different parameters by local technicians will prove to be too difficult. Furthermore, it must be borne in mind that this calculation only results in an "estimation" of the needed storage capacity. Therefore, TS is exceeded once in 10 years, and T10S is directly derived from rain-

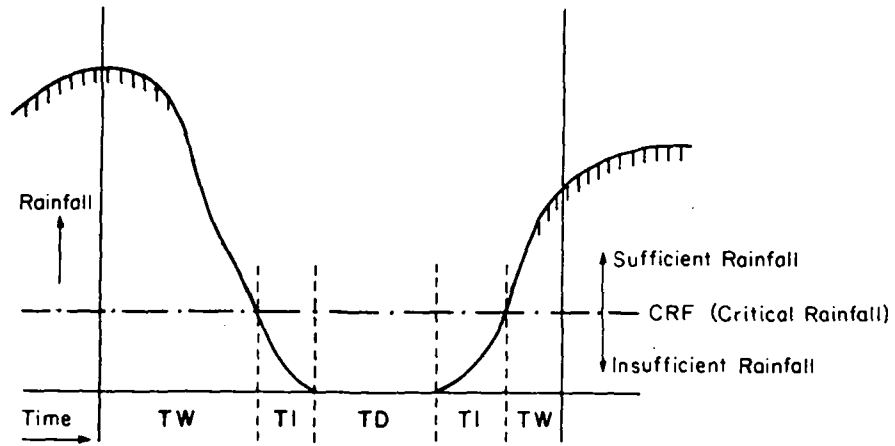

Figure 2. Annual rainfall in relation to water supply by rainwater catchment

fall data and not calculated with statistical parameters. Thus, if about ten years of rainfall data are available, the highest value for T10S is selected; and if the storage is insufficient only once in 20 years, then  $T_{20S} = 1.1 \times T_{10S}$ . Although this is a rough calculation, it seems to work well in our case as shown in Figure 3.

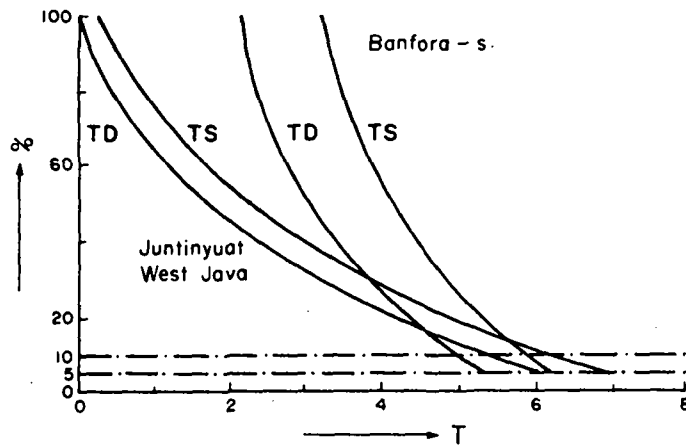

Figure 3. Cumulative frequency distribution length of dry TD periods and length of periods supplied by water tank

During TI, the period of insufficient rainfall, only part of the outflow is supplied by rain catchment; the rest should be provided from storage. To calculate this condition, the shortage factor,  $s$ , is used. Thus, in Figure 4,  $r$  = rain water supply and  $s$  = the storage addition. One should also take into consideration that during the first light shower, rainfall often evaporates

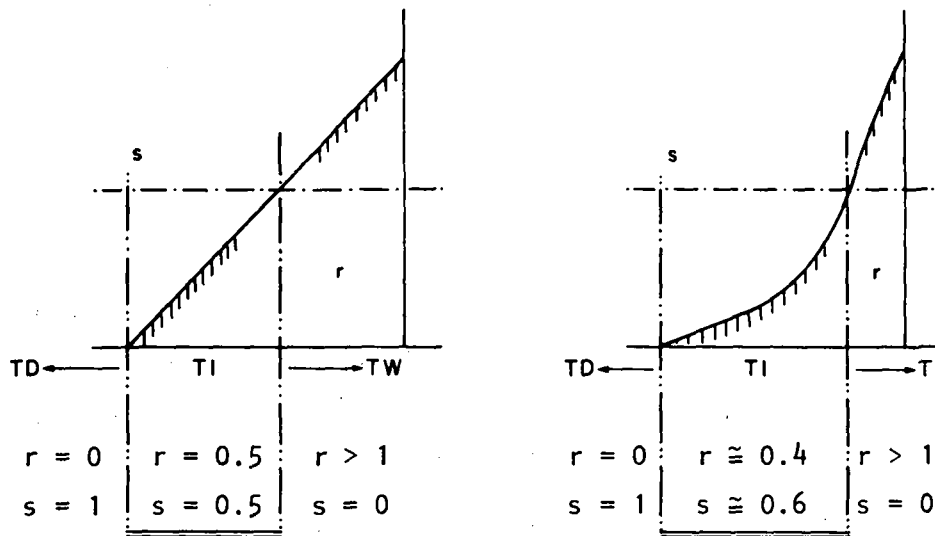

Figure 4. Section of graph showing period of insufficient rainfall

when it falls on hot surfaces, such as roofs. For example, when the  $s$  value is theoretically 0.5, use  $s = 0.55$ . Thus,  $TS = TD + s \times TI$ . Because the value of  $s$  is difficult to determine for Indonesian conditions, the shortage factor,  $s$ , can be put at 0.6.

To obtain the  $TmS$ —such as the  $T10S$ , which is the storage-supply period,  $TS$ , that is exceeded once in ten years, the  $TD$  and  $TI$  is elaborated on the rainfall data sheet into  $TS$  by using the relation of  $TS = TD + s \times TI$ . For the  $TS$ , the highest value for  $T10S$  is used if ten years of rainfall data are available. Then, if 20 years of rainfall data are available, we use  $T10S = 0.9 \times$  the highest value or  $T10S = 0.0 \times T20S$ .

Now that we know the  $TmS$ , we have to find an expression for the necessary volume of storage. To calculate this volume,  $VSTOR$ , the discharge,  $OUT$ , must be first determined. This discharge can be divided into consumption, leakage and evaporation. Consumption is difficult to determine exactly; and to do so, the following questions must be answered:

1. How (cooking, drinking, bathing, irrigation) will the water be used?
2. What quantities per month per use per family members per animals per hectares will be required?
3. How many family members, animals and hectares will require water?

Based on these consumption factors, the monthly consumption is expressed as  $MC$ . The leakage related to the volume of stored water which decreases over time is expressed as

$$OUT_{leakage} = \frac{1}{2} \cdot L \cdot VSTOR \cdot TmS.$$

Evaporation is proportional to the open water surface, temperature, wind conditions and time. To simplify this calculation, we used Penman's simple



relation of

$$\text{OUT}_{\text{evaporation}} = A \cdot E \cdot \text{Time.}$$

Using Penman's constant, E, in this relation, E may amount to 0.1 m/mo for Indonesian conditions. To obtain the total outflow times the length of the period that the storage has to meet demand in the needed volume, let

$$\text{VSTOR} = \frac{(\text{MC} \cdot 10^{-3} + A \cdot E) \cdot \text{TmS}}{1 - 0.5 \cdot L \cdot \text{TmS}}$$

in which MC is expressed in ℓ, A in m<sup>2</sup>, E in m/mo and TmS in mo.

Following the step-by-step method, the local technician should be able to easily calculate the VSTOR relation on his sliderule.

DESIGN CONSIDERATIONS. In closing, I would like to suggest the following design considerations:

1. Use an impervious as possible lining, such as plastic sheets or a thin lining of bamboo cement or ferrocement laid on the natural slope of the ground
2. Minimize evaporation by installing a roof or covering the cisterns with soil or concrete; wood should not be used
3. Filter the inflow at the entrance point of storage to eliminate dust and foreign matter
4. Guard against mosquitos or their larvae especially the species that are carriers of diseases.

In addition, users should be taught to boil water used for drinking purposes if the water quality is questionable. I do not pretend to have given a complete listing of all design considerations for rainwater cisterns. The viewpoints presented in this paper are the results of lessons experienced in our West Java Rural Watersupply Project.

#### REFERENCE

Satijn, H.M.C. 1979. *Hydrological investigation of rainwater collecting systems*. Internal Rep. IWACO, Rotterdam, The Netherlands.

ASSESSMENT OF RAINWATER CATCHMENT  
AND STORAGE SYSTEMS ON MAJURO

Rebecca A. Stephenson  
Assistant Professor  
Department of Anthropology  
University of Guam  
Mangilao, Guam 96913, USA

Hiro Kurushina  
Assistant Professor  
Micronesia Area Research Center  
University of Guam  
Mangilao, Guam 96913, USA

Stephen J. Winter, Director  
Water and Energy Research Institute  
of the Western Pacific  
University of Guam  
Mangilao, Guam 96913, USA

INTRODUCTION

This paper focuses on a discussion of freshwater supply systems in Micronesia. Particular attention is paid to the conditions within a small Micronesian atoll environment of the Marshall Islands, the village of Laura on Majuro atoll.

Initial fieldwork during July to August 1981 revealed that a paradox exists between the abundant availability of fresh water as rain water and groundwater on the one hand, and frequent shortages of fresh water, on the other. In the course of earlier field research by Winter and Stephenson (1981) in the Eastern Caroline Islands, Micronesia, the same paradoxical condition was found to exist.

We suggest that the paradox exists because of an inadequate management of water supply and water storage systems in Micronesia. We further suggest that economic, technical and social factors may be related to this phenomenon. The paper describes the study area in the Marshalls, discusses local water supply and storage systems, examines attitudes towards the use of groundwater versus rainwater catchment, and attempts to explain why rain water is not utilized more extensively than it is. The paper concludes that, as water consumption is most likely to increase along with modernization in Micronesia, government plans should provide for increased water supply.

STUDY AREA

Laura village is an atoll community in the southern Marshall Islands of Micronesia. Code-named Laura by the U.S. Navy, the settlement occupies an elbow-shaped islet at the west end of Majuro atoll. Laura is 3 700.70 m (2.3 miles) long by 1 174.57 m (0.73 mile) at its widest point; the maximum elevation is about 6 m (20 ft) above sea level. Access to the village is by automobile across a long causeway that links Laura to the district center in Majuro, the Darrit-Uliga-Dalap area (DUD), Navy code named Rita. Constructed in 1961, the causeway is 56 315.0 m (35 miles) in length, and, at the present, is the longest paved road in Micronesia. Laura village encompasses some 200 households and is within the jurisdiction of Irioj (traditional Chief) and an

elected senator to the Marshall Islands Parliament. The settlement of Laura is divided into wato, strips of land running across the islet from the sides of the lagoon to the ocean. Wato are held and administered by individual matrilineage or descent line groups (Alkire 1977; Mason 1967).

Majuro atoll itself is long, narrow and flat with an average elevation of only a few feet above sea level. Brackish groundwater occurs generally as a Ghyben-Herzberg lens. The coral-based soil is highly permeable, allowing for little or no surface runoff, in spite of the average annual rainfall of 3 835.4 mm (151 in.). For this reason, and because of the small size of the islands, no streams occur on Majuro. Consequently, island residents must seek fresh water through other means.

In the course of the field research in Laura, two anthropologists and two Marshallese research aides conducted a household survey among a selected sample of 41 households, asking questions in regard to the development and use of freshwater resources in the village. Rainwater catchment and storage devices were examined and photographed. Groundwater samples from household wells were tested for chloride and bacteria. The findings of the field research form the basis of this report.

#### LOCAL WATER SUPPLY AND STORAGE SYSTEMS

In the village of Laura, the two major sources of fresh water are rain water and groundwater. Local villagers utilize both sources to obtain needed fresh water. In the rainy season, rain water and groundwater are plentiful. During the dry season, however, acute rainwater shortages are experienced.

Informants in Laura were asked to identify sources of their freshwater supply. For drinking, rain water is almost exclusively preferred over well water (92.7%). For cooking food and washing dishes, 78% of the informants said they use rain water. For bathing and washing clothes, people rely primarily on well water (63.4% and 57.5%, respectively).

Rain water is collected on rooftops and routed by gutters to various types of storage devices. These consist of portable containers (e.g., plastic buckets), semipermanent containers (e.g., barrels, airplane fuel tanks), and permanent cisterns made of metal, rubber, or—most commonly—concrete. Storage capacity varies from 0.011-m (3-gal) plastic buckets to 3.785-m (1000-gal) concrete cisterns. In order of technological sophistication, these rainwater collection and storage systems are listed below according to frequency of occurrence in the sample of 41 households.

TABLE 1. TYPES OF RAINWATER SYSTEMS AND FREQUENCY OF OCCURRENCE

RAINWATER SYSTEMS		FREQUENCY
Type	No.	OCCURRENCE (%)
No device	7	17.1
Portable containers	3	7.3
Semipermanent containers	2	4.9
Incipient gutter, semipermanent containers	3	7.3
Gutter, portable container	1	2.4
Gutter, semipermanent container	6	14.6
Gutter, cistern	19	46.3

Clearly, the greatest number of people in Laura utilize rooftop rainwater catchment along with a gutter and cistern system. However, the above table also indicates that a significant number (36.6%) of people still rely upon makeshift means of rainwater collection.

Although abundant in number, groundwater wells in Laura serve as a secondary source of fresh water to supplement rain water. Approximately 200 wells have been constructed in the village. In the sample survey of 41 households, all have wells on their property. The table below delineates the type of well and the frequency of each type.

TABLE 2. TYPES OF WELLS AND FREQUENCY OF OCCURRENCE

WELLS		FREQUENCY
Type	No.	OCCURRENCE (%)
Sand pit	1	2.4
Coral block	1	2.4
Coral block & concrete	1	2.4
Coral block & drum can	1	2.4
Cement/concrete	4	9.8
Drum cans (2 to 7)	32	78.1
No structural data	1	2.4
	41	99.9

Various devices are used to draw water from the wells. The most common device is a 3.785-ℓ (one-gal) tin can, such as a flour can (31 cases). Other devices include a teapot, plastic bucket, hand pump, diesel-powered pump, and an electric pump.

As with rainwater systems, wells may be used by individual households or shared with other families. Nearly 50% of the households surveyed shared their wells with two or more families. Other families are sole users of their wells.

A preliminary survey of well water quality was made in Laura. Bacterial tests of the groundwater during the August 3-6, 1981 period show that the number of bacteria present in the water samples is too numerous to count in more than half of the collected samples. Contamination of well water probably results from the casual sanitary habits of village residents; 14 families (34%) reported that they had no toilet facilities. Some families pen their pigs close to their well. Accordingly, it is not surprising that the rate of water contamination appears so high. In atoll environments where space is limited, water use practices and sanitation habits as they exist may be mutually incompatible.

#### ATTITUDES TOWARD USE OF GROUNDWATER VERSUS RAINWATER CATCHMENT

In the course of the sample survey, over three-fourths (76.9%) of the respondents indicated that they felt fresh water, in general, should be regarded as a limited natural resource. When asked under what conditions fresh water should be seen as a limited natural resource, 88.5% of the respondents answered, "In the dry season, particularly." Others (11.5%) spoke of fresh water as a natural resource that is limited in quantity at all times. Surprisingly, in response to the following question, "Does your family conserve

water?", only a little over half of the informants (54.5%) replied in the affirmative. In light of the number of people who regard fresh water as a limited natural resource, it would seem that more of them would practice water conservation.

All the houses included in the sample survey have wells as part of the house compound. Yet, people do not rely on well water. Local people say that groundwater tends to be brackish. Rain water is viewed as clean and pure. Additionally, rain water is convenient to use when stored in containers near the house or under the house eaves where portable containers are placed to catch roof runoff. With well water, people feel that more labor is involved in order to use it. Most wells are deep, some as much as 3 m (9 ft). Therefore, drawing out the water is viewed as physically demanding. A number of informants said their wells have become dirty: "The water is not contaminated",...."There is junk in the well" (e.g., rusty cans, discarded zoris, boards and planks). When wells are used as convenient dump sites, it seems clear that people have mixed views as to the value of wells and well water.

Informants were asked, "Are you satisfied with the present condition of your water supply system?" In the sample, 22 heads of households (55%) answered "no". They were asked then how they might consider improving their water supply system at home. In response, twelve people (36%) said specifically, "Build more water catchment facilities" and "Build more gutters." Only one informant in the sample of 41 households (3%) mentioned fixing his well. It is clear that improvement of water supply systems for local people is viewed in terms of utilizing rainwater facilities rather than well water.

#### WHY RAIN WATER IS NOT MORE EXTENSIVELY UTILIZED THAN IT IS

Since residents of Laura village so clearly prefer to use rain water rather than well water, it would seem that they would have very efficient rainwater catchment and storage systems. This is not the case. Of the 41 houses observed, only three make use of 100% of their available roof surfaces in the construction of permanent rain gutters. Of the remaining households, 31.7% utilized approximately 50% of the roof surface, as usually only one side of the house is supplied with a gutter. The remaining households (25) use 25% or less of the roof surface.

The reasons for not making maximum use of the available roof surfaces are many and varied. Clearly, some of the reasons are perceived as economic in nature. In the sample survey, 18 household heads (48.6%) mentioned that they could not afford to purchase additional gutters and/or barrels. No one, however, spoke of making do with wooden troughs or make-shift gutter-like devices. Four persons (10.8%) explained that their houses were still being build; the building process, however, had been going on for several years. Apparently, no need was perceived to build a temporary gutter. One informant explained the lack of gutters on his house by pointing out that it was a very old dwelling. It seemed as though maintenance of the house was no longer necessary. Three persons (8.1%) indicated that such a home improvement was not a high priority item because "We can get water from the neighbors." In the total sample, 8 persons (21.6%) simply did not perceive a need for further improvements to their rainwater catchment systems, in spite of the fact that 100% of their roofs were not utilized for catchment purposes.

A lack of technical skills needed to design and construct an effective gutter and catchment system was implied when several women and children who were serving as informants mentioned that the male head of their household was deceased, or was not living in Laura at the time of the study. The same lack of technical expertise was implied by informants who were older men, saying that they had no plans for further household improvements. A key social factor may be mobility of the Laura population. People shift about to different homes within the community, to outer islands and into Rita for indefinite periods of time.

It has been suggested that the time perspective in Micronesia differs from the Western concept. A present-day orientation prevails in Micronesia. The past is already gone and the future is an unknown quantity, thus making special plans for it is useless. Perhaps this explanatory framework is valid in the Marshall islands. Looking ahead to the future may be practical in plant cultivation (Klee 1976); however, in household matters, daily requirements take first priority. When enough rain water is available for today, why worry whether a sufficient amount of rain water will be available in the dry season? Such a daily coping strategy may be tempered with a certain degree of fatalism: "The dry season will come when it comes; anyway, can't be helped."

#### SUMMARY AND CONCLUSIONS

In this paper, the status of freshwater resources in Micronesian islands is examined. Particular attention is paid to Laura village on Majuro atoll in the Marshall Islands. The apparent paradox between the abundant availability of fresh water on the one hand and water shortages in Laura on the other is examined carefully using ethnographic data. The study shows that the water shortage problem is not caused by environmental factors, but, rather, that it is a phenomenon induced by socioeconomic factors. In addition to the factors discussed above, a lack of systematic planning appears evident in a house-by-house examination of individual water catchment and storage facilities. Careful planning of water supply systems at the household level should result in a more satisfactory water supply, given the rate of high annual rainfall, except perhaps during prolonged periods of drought. A few home owners already recognize this situation. Thus, their homes are provided with adequate facilities for catchment and storage, and these families do not generally experience water shortages.

While it appears that many of the water-related problems may be solved or reduced at the household level, facilitation for easier purchase and installation of gutters and the construction of large water storage devices, such as concrete cisterns, could be undertaken at the community or regional governmental level. Also, it is important to point out that, as modernization takes place in remote atolls in Micronesia, water consumption is most likely to increase. Introduction of flush toilets, showers, and washing machines in the villages will undoubtedly place further demands on freshwater sources for domestic uses. For the projected future development and modernization of these rural areas, governmental plans should provide for increased water supply and, perhaps, an investigation for further development of the groundwater.

## REFERENCES

- Alkire, W.H. 1977. An introduction to the peoples and cultures of Micronesia. 2d ed. Menlo Park, California: Cummings.
- Klee, G.A. 1976. Traditional time reckoning and resource utilization. Micronesia 12(2):211-246.
- Mason, L., ed. 1967. The Laura report. Joint report by the University of Hawaii Department of Anthropology, The East-West Center Institute of Technical Exchange, and Marshalls District Administration, Trust Territory of the Pacific Islands.
- Winter, S.J., and Stephenson, R.A. 1981. The development of a village water supply system in Truk. Tech. Rep. No. 28, Water and Energy Research Institute of the Western Pacific, University of Guam.

## ADJUSTING OPERATION POLICY FOR A RAIN WATER CISTERN SYSTEM

Andrew Lo, Graduate Assistant  
Department of Agronomy and Soil Science  
University of Hawaii at Manoa  
Honolulu, Hawaii 96822, USA

Yu-Si Fok, Professor  
Department of Civil Engineering  
and Researcher  
Water Resources Research Center  
University of Hawaii at Manoa  
Honolulu, Hawaii 96822, USA

### INTRODUCTION

Rain water cistern systems have long been a water supply source in many countries. In some rural areas where municipal water is limited or unavailable, rain water for domestic use is caught on roofs and stored in water tanks. To design an efficient catchment system, adequate catchment area and cistern capacity in relation to water demand are factors that have to be carefully selected and designed to suit the rainfall pattern of the design area. If the average rainfall could be daily obtained, only enough catchment and storage would be needed to satisfy respectively the daily water demand and peak loads. However, there are many areas with frequent droughts that can last for months. Severe water shortage problems emerge even with extremely large catchment and storage. To alleviate such problems, the operating rule of the catchment system must be modified. Appropriate water use reduction imposed prior to the onset of dry weather may save enough water to last through the drought.

The following sections describe a linear and a non-linear reduction strategy, and their performance is compared to the classical unadjusted operating policy. Conclusions are then drawn in relation to the proper form of rain water cistern system operation policy.

### OPERATING RULES

The operation policy of a rain water cistern system resembles that of a reservoir (Lo and Fok 1981). Input from rain water is stored in a reservoir or cistern; output is water withdrawn or released for irrigation and drinking water. If too little water is released, the dam or cistern may overflow. If too much is released, there may not be sufficient input to replenish storage for subsequent release. The problem faced by a reservoir or cistern operator is the maintenance of a constant balance between immediate returns from water release and the possible subsequent losses because of too high or too low a storage level. The objective, then, is to select the most efficient operating rule which yields the least deficit periods and which minimizes losses.

**CLASSICAL OPERATING RULE.** According to Fiering and Jackson (1971), the normal operation policy of a reservoir is that if the available water (inflow plus storage) is less than the target demand, all the water is released; if the total available water exceeds the target demand plus reservoir capacity, all additional water less the reservoir volume is released; and if the available water lies between the target demand and target plus reservoir capacity, the water released exactly equals the target demand.



For a cistern system, the above operating rule must be modified to include a minimum storage requirement. This minimum requirement is necessary because the bottom 50.8 to 76.2 mm (2-3 in.) of the cistern is usually filled with sediment and cannot be used. In addition, this minimum also provides water for protection against unforeseen small fires. When rainfall enters the storage tank which overflows if the capacity is exceeded, the target demand is then withdrawn because sufficient water is available. If not, only the amount exceeding the minimum storage is released. This model is referred to as the "yield after spillage" model by Jenkins and Pearson (1978).

LINEAR-REDUCTION OPERATION POLICY. To avoid cistern emptying and making up deficits by obtaining water from other sources, Wentworth (1959) suggested that a water conservation practice is needed during dry weather and especially when water in the storage tank is half or less than half full. The amount of reduction and when to reduce depend largely on the individual's perception to risk. An optimistic cistern owner will allow the storage to fall below the halfway point before reducing his target demand. A pessimistic owner will withhold lavish usage as soon as the cistern is slightly less than full. These two extremes may sometimes result in unfavorable situations. Cutting back too late and not reducing withdrawal hastens cistern emptying, resorting to alternative water sources, and resulting in capital loss. Cutting back too soon and too much restricts water release which may cause unnecessary spillage and benefit loss.

Obviously, the best operation policy lies between the two extremes. The simplest and systematic approach to the problem is the linear reduction scheme, in which water use is reduced in proportion to currently available water. This policy is illustrated in Figure 1 and can be represented by the formula,

$$D/T = -0.05 + 1.053 \cdot S/Q$$

where

- $D$  = reduced draft
- $T$  = target draft
- $S$  = available water (inflow + storage)
- $Q$  = cistern capacity.

During a long period of dry weather, this draft rule curtails water release at the very beginning of the drought to hopefully extend water storage throughout its duration. The only drawback suffered by this rule occurs during short dry periods. Instead of switching to a lower consumption rate, water equivalent to the target demand should have been released because the subsequent inflow would more than make up for the current deficit.

NON-LINEAR REDUCTION OPERATION POLICY. Another more complex operating rule which may be useful in cistern management follows a curvilinear function. This rule is often referred to as the non-linear operation policy and is illustrated in Figure 1.

The non-linear operation policy deviates a great deal from the linear reduction scheme. The release is greater at any level of storage, except when the storage tank is full—the main feature being the steep decline at 40 to 60% storage and the smoother reduction at both ends of the scale. The reasoning behind this is that the most critical period occurs when the storage tank is half full. If enough water is saved during this time—along with continued

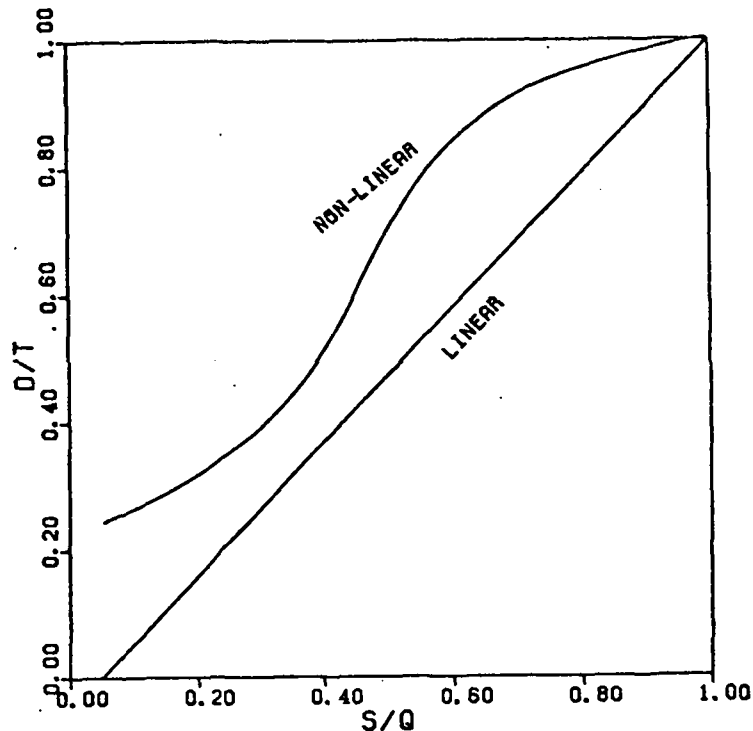

Figure 1. Linear and non-linear reductions for a rain water cistern system

conservation, the risk of an empty cistern is greatly reduced. At the critical level, water conservation is not much of a problem. At the other extreme, drastic reduction may be too late to improve the already serious situation. Since reduction is relaxed, the non-linear operation policy is less conservative than the linear operation policy and obviously more profitable. However, the chance of its failure to maintain adequate water supply through long, dry-weather periods needs to be investigated.

#### BENEFIT-PENALTY FUNCTION

To assess the performance of different draft schemes, the quantitative (dollar) aspect is generally easier to consider. An estimate of the benefit or penalty function for a cistern system is rather difficult, since water demand is not price dependent. For the sake of convenience, a maximum benefit of \$5 (U.S.) is used for unlimited water use. This benefit diminishes non-linearly as water use becomes more and more restrictive. The benefit function is shown in Figure 2.

When the target demand is not met, cistern owners have to make up deficits from other sources. In the worst case, residents have the option of hiring water trucks to deliver water to their homes. The cost of hauling  $5.68 \text{ m}^3$  (1500 gal) of water is \$5 for the water and \$100 for delivery in Hawaii. Using this as the extreme, a quadratic penalty function (Fig. 2) is chosen. The ratio of reduced draft and target draft ( $D/T$ ) value of 0.4 is also selected as the break-even point, at which the penalty is exactly balanced by benefit.

## CASE STUDIES

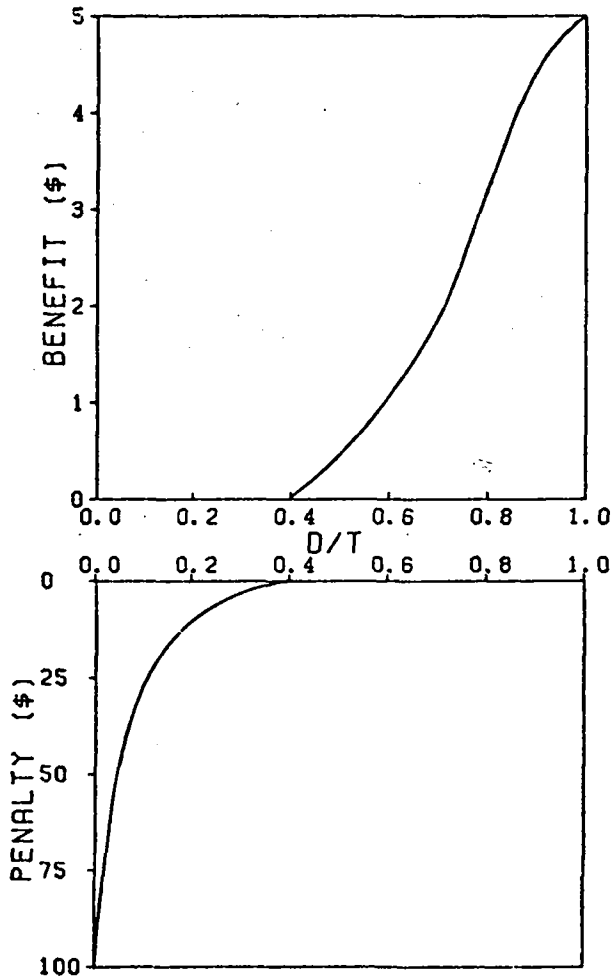

Figure 2. Benefit-penalty function for operating rules

Pauoa Flats, and in Figure 4 for Manoa Tunnel 2.

Historical records from two rainfall stations located in the Tantalus area, Honolulu District of Oahu, were used as input. The two stations have weekly rainfall records from 1952 to 1976. The average annual rainfall at the first station, Pauoa Flats, is about 3 810 to 4 064 mm (150-160 in.); and at the other station, Manoa Tunnel 2, about 3 556 to 3 810 mm (140 - 150 in.).

To compensate for the rainfall difference, a larger catchment area of 176.51 m<sup>2</sup> (1900 ft<sup>2</sup>) was designed for Manoa Tunnel 2; whereas only 148.64 m<sup>2</sup> (1600 ft<sup>2</sup>) was allowed for Pauoa Flats. The maximum capacity of the cistern and the target draft at both locations were assumed to be respectively, 37.85 m<sup>3</sup> (10,000 gal) and 9.09 m<sup>3</sup> (2400 gal) per week. The design model included the routing of weekly rainfall through the system, and using the operation policy and the yield-after-spillage model. The water use benefit and deficit penalties were computed and the difference between benefit and penalty termed the net return. The annual summary of the net return obtained for each operation policy is shown in Figure 3 for

## RESULTS AND DISCUSSION

During wet years, the unadjusted operating rule performs better than the other two and, unfortunately, fails badly in dry years. The most disastrous case occurred in 1976 at Manoa Tunnel 2. The cistern emptied twice within the same year and, thus, resulted in a negative annual net return. Although the number of wet years is greater than the number of dry years for this period the high penalty price is a bit too much to pay.

The other two adjusted operation policies remained rather stable throughout the entire period. For both schemes, incidents of cistern emptying were not encountered. In 1976, water use dropped to less than 3.79 m<sup>3</sup> (1000 gal) per week for a total of eight successive weeks at Manoa Tunnel 2. The lowest rate was about 1.51 m<sup>3</sup> (400 gal). This low consumption rate can be met if residents make a definite effort to conserve their remaining water supply by bathing and laundering elsewhere, cutting down on toilet flushing, and curtailing parties. Between the two adjusted schemes, the non-linear reduction rule is

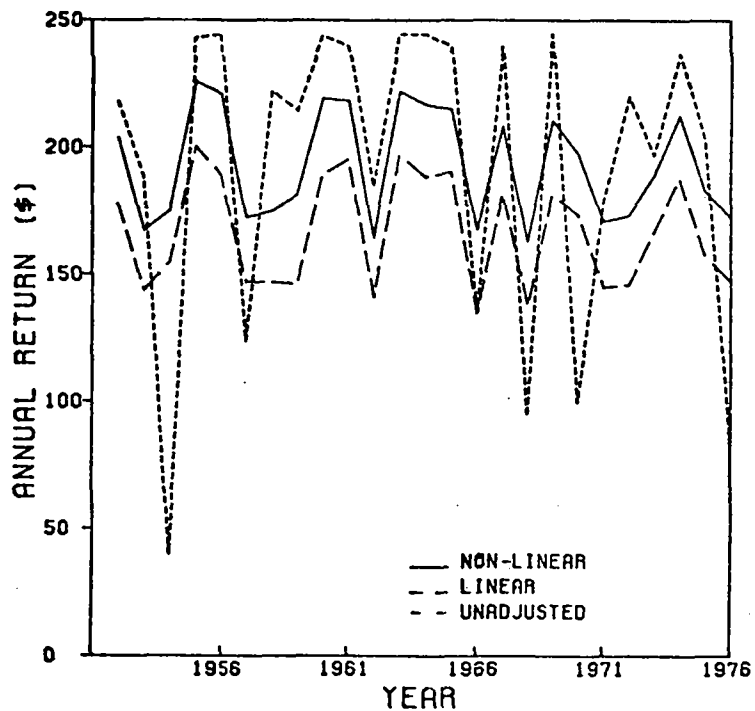

Figure 3. Comparison of three operation policies on annual net returns, Pauoa Flats

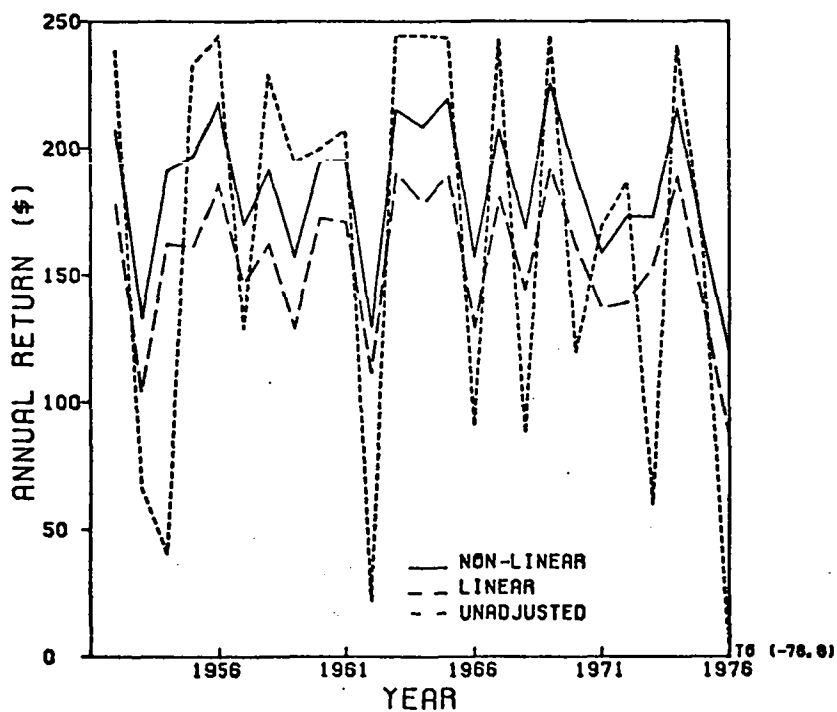

Figure 4. Comparison of three operation policies on annual net returns, Manoa Tunnel 2

much preferred since higher net returns were obtained throughout the data period at both locations.

The performance of these operation policies during the entire period can be compared in relation to factors such as, benefit, penalty, net return, and the number of cistern emptying times (Table 1). The higher penalty price for Manoa Tunnel 2 may be attributed to its large monthly or shorter periods of rainfall variation when there was often no rainfall for several or many weeks. In general, the net return for all three policies was quite similar. Smaller returns were associated with the more conservative linear reduction policy. Both adjusted policies showed substantial improvement in the penalty category over the unadjusted policy; therefore, the classical operation policy is not suitable for cistern systems. Furthermore, numerous occasions of cistern emptying are usually considered undesirable for good cistern management.

TABLE 1. OPERATION POLICY PERFORMANCE

Operation Policy	Benefit	Penalty (\$)	Net Return	No. of Cistern Emptying Times
Pauoa Flats				
Unadjusted	5664	844	4820	3
Linear Reduction	4187	22	4165	0
Non-Linear Reduction	4845	22	4823	0
Manoa Tunnel 2				
Unadjusted	5525	1463	4062	5
Linear Reduction	3969	74	3895	0
Non-Linear Reduction	4649	67	4582	0

The adjusted policy penalty was identical for Pauoa Flats and slightly less for the Manoa Tunnel 2 station when the non-linear policy was used. This suggests that the non-linear policy serves not only to release an adequate amount during short dry period (increased benefit), but also to conserve enough water during long dry periods (minimized penalty).

#### CONCLUSIONS

Results of this study indicate that good cistern management practice requires an appropriate operation policy. The classical operation policy should be modified for a rainwater cistern system. Reduced water consumption rates are necessary when the water storage is low and/or the expected rainfall is low. The reduction strategies—linear or non-linear—satisfy the objective to avoid cistern emptying during long periods of dry weather. The only drawback of using the linear reduction policy is that it is too conservative and restricts water use during short dry periods. The non-linear reduction policy, which allows sufficient water use during short dry periods while cutting back enough to last through long dry periods, is considered the proper form of op-

erating rule for rainwater cistern systems.

#### REFERENCES

- Fiering, M.B., and Jackson, B.B. 1971. *Synthetic streamflows*. Water Resources Monograph No. 1, American Geophysical Union, Washington. vii + 98 p.
- Fok, Y.S.; Murabayashi, E.T.; and Fong, R.H.L. 1979. Rainwater roof-catchment cistern system for residential water supply. In *III World Congress on Water Resources Proceedings*, vol. iv, pp. 1712-1716, International Water Resources Association, at Mexico City, Mexico, 23-27 April 1979.
- Fok, Y.S.; Fong, R.H.L.; Hung, J.; Murabayashi, E.T.; and Lo, A. 1980. *Bayes-Markov analysis for rain-catchment cisterns*. Tech. Rep. No. 133, Water Resources Research Center, University of Hawaii, Honolulu. viii + 100 p.
- Jenkins, D., and Pearson, F. 1978. *Feasibility of rainwater collection systems in California*. Contrib. No. 173, California Water Resources Center.
- Lo, A., and Fok, Y.S. 1981. Application of a single-reservoir operation policy to a rainwater cistern system. *Water Resour. Bull.*, Paper No. 81077.

## RELIABILITY OF ROOF RUNOFF IN SELECTED AREAS OF INDONESIA

J.L. Irish  
Former Regional Advisor  
in Hydrology, Unesco\*  
Jakarta, INDONESIA

Sukarna, Meteorologist  
Meteorological and  
Geophysical Service  
Jakarta, INDONESIA

D. Murdiyarso, Lecturer  
Agricultural Climatology Section  
Institut Pertanian Bogor  
(Agricultural University)  
Bogor, INDONESIA

## INTRODUCTION

Indonesia, an archipelago of about 12,000 islands spread 4 000 km east-west across the equator (Fig. 1), has a population approaching 160 million, with an estimated \$350 (1970) per capita gross domestic product, of which oil production represents about 18% and agriculture about 32%. Approximately 65% of the population lives on the island of Java (including the adjacent island of Madura), which has an area of only 132 000 km<sup>2</sup>, or less than 7% of the total land area. Other densely populated areas include Bali and Lombok, and the province of Lampung at the southern tip of Sumatra. More than two-thirds of the population live in rural areas, generally in villages or small towns, and engage principally in subsistence agriculture. Rice is the main crop; others of importance are maize, cassava, soya beans, copra, tea, coffee, rubber, palm oil and sugar.

The mean annual rainfall ranges from less than 1 000 mm in a few small areas (e.g., Palu Valley, Saluwest) to over 4 000 mm in exposed coastal areas and parts of Kalimantan and Irian Jaya. Estimates of mean annual rainfall and per capita water availability for each of the main island groups are shown in Table 1.

The population is largely concentrated on islands with water resources below the national average. This situation is aggravated by the seasonal pattern of rainfall that is most marked in the southeastern islands of Indonesia: Timor, Nusa Tenggara (Flores, Sumba, Sumbawa, Lombok, among others), Bali and Java, which have a "dry" season from May/June until September/October. Rarely does a month receive no rain at all, even in the dry season, except in Timor and the lightly populated parts of Nusa Tenggara where the wet cultivation of rice is only possible during the wet season and transition periods, unless advanced irrigation is practiced. Elsewhere in Indonesia, rainfall has a less marked seasonal pattern, and cropping throughout most of the year is possible in many areas (Oldeman, Las, and Darwis 1979; Oldeman and Syarifuddin 1977). Surface water resources are consequently more reliable in those areas than in Java and the islands to the southeast.

Rain generally occurs about 120 days per year, typically, as intense

---

\*Now with Worsley Alumina Party Limited, Perth, Australia.

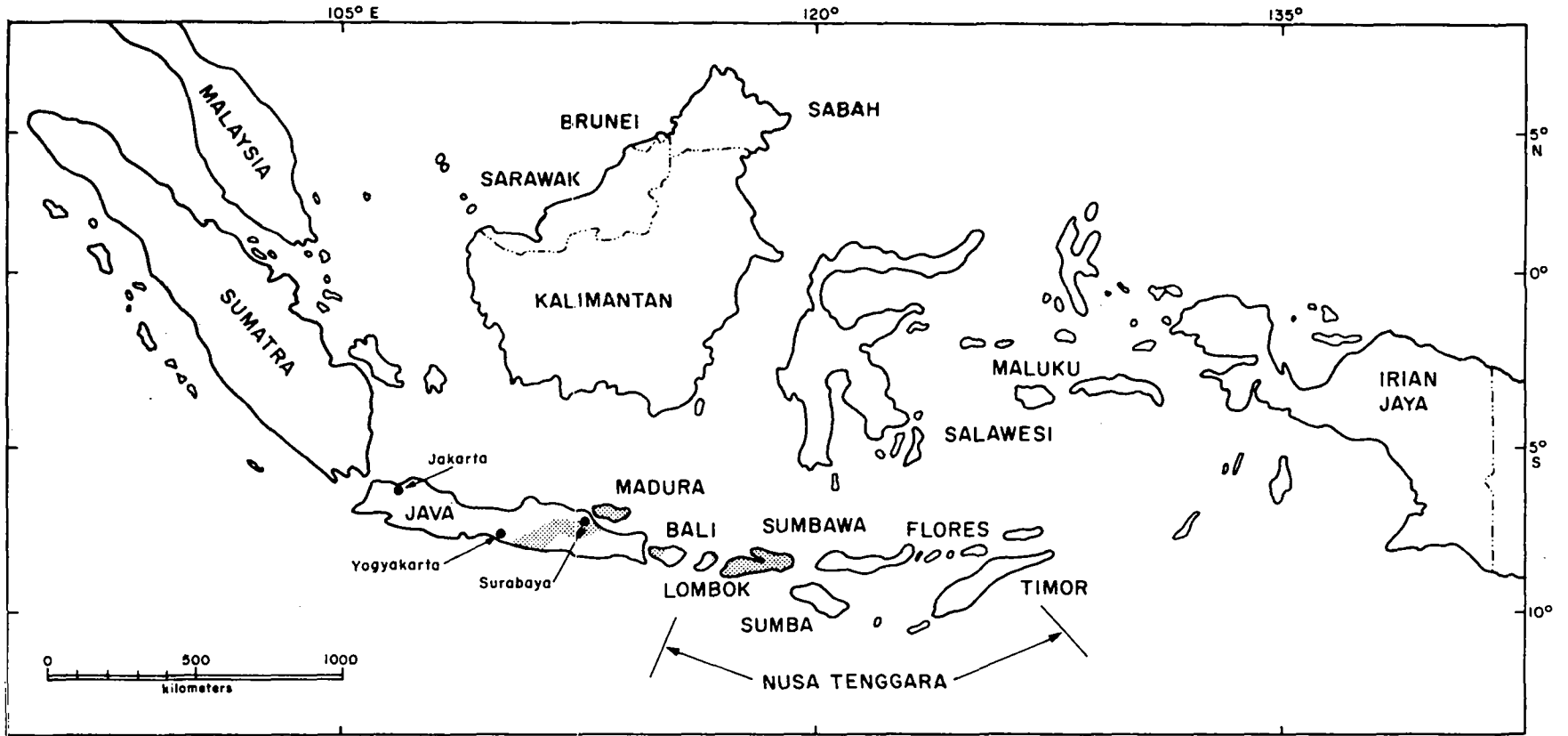

Figure 1. Map of Indonesia—locations referred to in text, and study area



TABLE 1. AREA, POPULATION, MEAN ANNUAL AND PER CAPITA VOLUME OF RAINFALL IN INDONESIA

Island Group	Area (10 <sup>3</sup> km <sup>2</sup> )	1971 Popula- tion (10 <sup>6</sup> )	Mean Annual Rainfall (mm)	Per Capita Volume of Rainfall (10 <sup>6</sup> ℓ)
Sumatra	474	20.8	2 825	64
Java and Madura	132	76.1	2 575	4.5
Bali	6	2.1	1 900	5
usa Tenggara	68	4.5	1 350	20
Kalimantan	540	5.2	3 000	310
Salawesi	190	8.5	2 350	53
Maluku	75	1.1	2 400	160
Irian Jaya	422	0.9	3 200	1 500
Indonesia	1 904	119.2	2 800*	45†

SOURCE: After Sujadi (1974).

\*Weighted rainfall average.

†Average.

bursts. Pan evaporation is relatively uniform—spatially and temporally—being about 1 500 mm/yr.

Public water supply is reticulated only in the largest towns and cities of Indonesia; elsewhere, the source of water is from streams or wells, or from stored roof runoff. During the dry season, people walk several kilometers or more in many parts of southeastern Indonesia to obtain water.

The Indonesian government is implementing a series of five-year development plans. The current plan, REPELITA III, emphasizes the goal of equitable social development as a result of the rapid growth in the value of exports (oil, timber, tin, rubber), an expanding manufacturing sector, and improvements in agricultural productivity. Transmigration from Java and Bali to the outer islands is being encouraged, and a successful family planning program hopefully will limit the population explosion. In line with the United Nations' International Drinking Water and Sanitation Decade, Indonesia is promoting the improvement of water supplies as a basic step toward better health and welfare. Many of these projects are small in scale and geared to rural villages, where the majority of the population lives, and to which special programs are directed. One such program involves UNICEF (a UN agency concerned with the welfare of women and children) and the government of Indonesia for selected regions, mainly the poorer and relatively dry areas of Yogyakarta, Madura, East Java and Lombok.

Little in the way of hydrological studies has been done to support the current program to increase the use of roof-runoff systems in villages. Instead, the approach has been to improve access to potable water and to allow villages to determine the safe yield from experience. The United Nations Educational and Cultural Organization (Unesco) decided to support a hydrologi-

cal study, financed from its regional component of the International Hydrological Programme (IHP), to demonstrate technology transfer and the methods of applying technology appropriate to the needs of a developing country. This is consistent with the rational use and management of national water resources emphasis in the later phases of the IHP, and extends and is consonant to the synthesis of scientific knowledge, education and training of the International Hydrological Decade and the first phase of the IHP.

Village water supply projects are being implemented at numerous sites throughout the nation. This hydrologic network, which should cover a broad area, is based on planning that recognizes the large gradients of mean annual rainfall in the typical mountainous terrain of much of the highly populated areas.

A large quantity of daily and monthly rainfall data are available in Indonesia: the Dutch colonists were pioneers in the collection and study of such data. There are at present over 3000 sites (whose station density roughly approximates the population) that regularly report daily rainfall to the national Meteorological and Geophysical Service. By 1922, there were already 2800 stations with five or more years of data; by 1941, this had increased to 4400 stations. The Pacific War, the disruption during the struggle for independence and the political turmoil of the 1950s and the early 1960s reduced the number of stations making regular climate or rainfall reports; however, this has been redressed in the last decade. A computer has recently been installed to store and retrieve climatological data, and monthly rainfall has been published in yearbooks for more than 80 years. However, the shortage of trained personnel in the provinces, and especially outside the cities, means that these data are hardly accessible to many potential users.

It was therefore decided to carry out a regional study based on the UNICEF-GoI programme of village improvement. The techniques developed might then be applied elsewhere in Indonesia and generally in Southeast Asia by using local data to obtain relevant statistical relationships. The area selected for study is broadly from Yogyakarta to Surabaya (parts of Central and East Java), the island of Madura, the drier parts of the island of Bali, Lombok and all of Sumbawa, an area of about 50 000 km<sup>2</sup> with a population of about 20 million.

#### STUDY METHOD

In Indonesia, the seasonal pattern of rainfall, which is uniform over only relatively short distances, is largely controlled by aspect and topography. In addition, there is a pronounced seasonality in southeast Indonesia that diminishes across Java and is absent over much of Sumatra. Important factors in storage-yield relationships are therefore expected to include location/seasonality, as well as mean annual rainfall. Boerema (1926) identified 69 rainfall types for Java and Madura and 84 types for the other islands. He used data from about 2200 and 600 respective stations to construct dimensionless histograms of mean and monthly rainfall, which he then grouped into contiguous districts on the basis of the similarity of the histograms for adjacent stations. In reality, there is a gradation of seasonality from one pattern to another across a rainfall-type boundary, but Boerema's regionalization seemed to be a useful starting point. Data collected since 1922, the classi-

fication of Schmidt and Ferguson (1951) and the studies of Oldeman and Sjarifuddin (1977) and Oldeman, Las, and Darwis (1979) support the location of boundaries between different rainfall types—except perhaps in the least populated areas where these still remain speculative.

It was decided to use monthly data instead of daily data, in view of the study time and facilities and also the pronounced seasonality of rainfall in the study area. A continuous sequence of 26 years of data for a total of 121 stations was used in the analysis to cover the range of elevation and mean annual rainfall within each of the ten rainfall districts or types of Boerema which cover the study area. This sample of 121 stations was selected from a total of 219 available in the area.

A preliminary study of 71 years of monthly data for Jakarta, including 11 years of daily data, indicated the range of storage volumes required to meet various target demands with given reliability. Ripple (1883) flow-mass curve diagrams were prepared separately for each year in which storage would have been required. These years can be readily identified by inspecting tabulated monthly data. For each target consumption rate, the required storage volume for each year has been tabulated and these series ranked to give a storage-yield-frequency of failure relationship (Fig. 2). It should be noted that estimating the amount of storage on an average failure frequency of more than about once in ten years would lead to a disastrous water shortage during failure years. On the other hand, estimates of the storage required for a smaller frequency of failure result in large standard errors when estimated from typical sample sizes. Thus, a compromise frequency of failure of 5%—an average of one year in twenty, was selected. From the Jakarta results, it is concluded that shortages in years of more severe drought than this particular design frequency will be modest: about one additional month of storage is required to improve the reliability from 95% to 99% of the years. A reliability greater than about 95% is not consistent with budget constraints and the basic objective of upgrading access to potable water to the largest number of people as rapidly as possible.

Houses in Indonesian villages are often close to one another, thus, the roof area draining to a tank can be increased by covering the area between dwellings. At the planning stage, the basic parameter is the monthly storage rate (number of people to be served), in liters. Other requirements include the various combinations of roof area and the storage volume to meet this demand at the required level of reliability. Trial designs can then be ascertained for the location of the storage tanks (each proportional in size to the roof area) and to determine whether it is more economical to increase the total roof area or the storage volume. The last step involves the determination of which households use which tanks, to balance the demand on the relatively large (5-30 kiloliter) tanks which have been found to be the most economical size for construction above ground. Thus, a simplified formula can be achieved if specific consumption,  $c$ , is expressed as liters per square meter of roof area per month, as

$$c = C/A \text{ liters/m}^2 \text{ mo} \quad (1)$$

which is equivalent to a depth of  $c$  millimeters for the entire roof area,  $A \text{ m}^2$ . The required specific storage volume, then, also has a depth dimension of

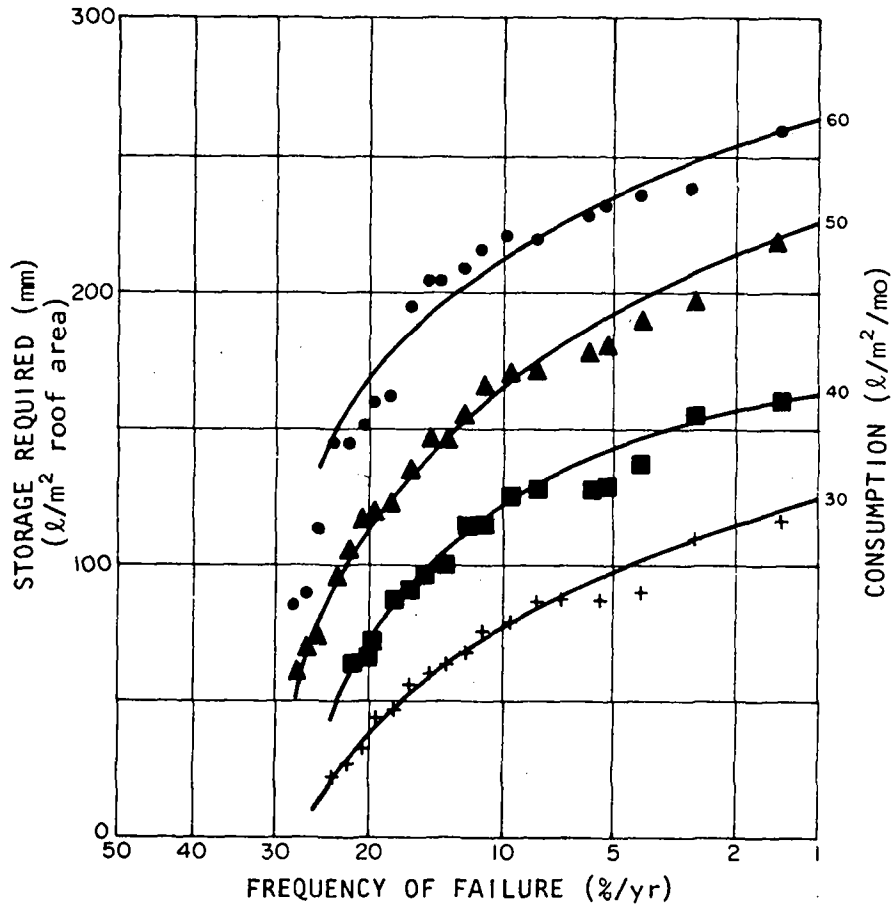

NOTE: 71 yr, mean annual amount = 1 764 mm.

Figure 2. Storage-yield relationships based on monthly rainfall data, 1870-1940, Jakarta, Indonesia

$$s = S/A \text{ mm.}$$

(2)

In studying the Jakarta data, it was found that the roof area was not being efficiently used if the specific consumption rate,  $c$ , were less than about 20 mm/mo, whereas, consumption rates exceeding about 60 mm/mo required excessively large, specific storage volumes (more than 200 liters/meter<sup>2</sup> of roof area). Large tank volumes are difficult to achieve because land values are high, tanks are located above ground level to minimize pollution, and tank height is limited by low roof levels. Behavior analyses for specific consumption rates of 20 to 60 mm/mo were concluded to cover the range likely to be encountered in practice. Specific storage estimates for 5% frequency of failure were obtained for each of the 121 rainfall stations for five specific consumption levels:  $c = 20, 30, 40, 50$  and  $60$  mm/mo. For each value of  $c$ , a linear regression was sought between  $s$  and a rainfall parameter,  $P$ , for each rainfall district (Table 2).

TABLE 2. RAINFALL TYPES, AMOUNT, NUMBER OF STATIONS, AND RANGE, JAKARTA, INDONESIA

DIS-TRICT	AREA	RAINFALL			
		Boerema Types*	Typical Mean Annual (mm)	No. of Station Samples	Range Parameter P† (mm)
1	Kedu and part of Yogyakarta	J32	2 500	15	205-785
2	Part of Yogyakarta	J39 (South)	2 200	7	182-360
3	Surakarta	J39 (North)	2 500	18	220-487
4	Madiun and Rembang	J42	2 060	23	168-484
5	Kediri and part of Surabaya	J46	1 900	15	132-250
6	Part of Surabaya and Pasuruan	J49	2 750	12	166-457
7	Madura	J67, J68, J69	1 500	18	242-492
8	Parts of Bali, Lombok and Sumbawa	65, 69	1 400	13	70-425

\*Boerema (1926).

†Sum of mean monthly amounts, five driest months.

### RESULTS

Using a variety of rainfall parameters, P, linear regressions of the form

$$s = a + bP \quad (3)$$

were sought. The highest coefficients of determination were obtained when P was the sum of the mean monthly rainfall for the five driest months, e.e., generally for the months of June through October. Yielding only slightly lower coefficients of determination, other rainfall parameters were the mean annual rainfall and the sums of the mean monthly rainfall for the three, four and six consecutive driest months. The correlation coefficients for equation (3), using the sum of the mean monthly rainfall for the five driest months as regression variable P, are shown in Table 3.

Of the 40 correlation coefficients, 29 are significant at the 1% level, 34 at the 5% level and all 40 at the 25% level, using the one-sided student-t test, with the usual assumptions. The five lowest values are all from District 5 (Kediri and part of Surabaya), for which the selected stations have ill-conditioned values of P: the range is only from 132 to 250 mm, and 11 of the 15 values of P are between 170 and 210 mm. Typical results for District 7 (Madura) are shown in Table 4.

The individual values of storage used to develop the regressions are judged to have standard errors of estimate, due to the use of only 26 years of record, of between 15 and 20%.

TABLE 3. CORRELATION COEFFICIENTS BASED ON SUM OF MEAN MONTHLY RAINFALL FOR FIVE DRIEST MONTHS AS REGRESSION VARIABLE P

DIS-TRICT	SPECIFIC CONSUMPTION (mm/mo)				
	20	30	40	50	60
1	-0.819	-0.822	-0.826	-0.813	-0.720
2	-0.894	-0.705	-0.678	-0.777	-0.539
3	-0.607	-0.607	-0.612	-0.634	-0.670
4	-0.674	-0.779	-0.773	-0.759	-0.768
5	-0.208	-0.235	-0.260	-0.237	-0.299
6	-0.592	-0.577	-0.717	-0.700	-0.771
7	-0.578	-0.672	-0.740	-0.782	-0.819
8	-0.795	-0.827	-0.874	-0.866	-0.873

TABLE 4. REGRESSION EQUATIONS FOR ESTIMATING SPECIFIC STORAGE FROM MEAN DRY-SEASON RAINFALL, P

Specific Consumption (mm/mo)		Correlation Coefficient	Std. Error of Regression $S_{y \cdot x}$ (mm) (N = 18)
20	$\hat{S} = 145 - 0.177P$ (14) (0.062)	-0.578	19.2
30	$\hat{S} = 231 - 0.277P$ (17) (0.076)	-0.672	23.6
40	$\hat{S} = 313 - 0.359P$ (19) (0.082)	-0.740	25.2
50	$\hat{S} = 402 - 0.451P$ (21) (0.089)	-0.782	27.7
60	$\hat{S} = 491 - 0.550P$ (22) (0.096)	-0.819	29.7

NOTE: Figures in parentheses are standard errors of estimate.

It is concluded that the sum of the mean monthly rainfall for the five driest months is a simple and useful predictor of the required storage volume and that a linear relationship is adequate.

In Table 4 it may be noted that there is a regular pattern in the linear regression coefficients a and b. These appear to be linearly related to the specific consumption, c, as

$$a = a_1 + b_1 c, \quad (4)$$

$$b = a_2 + b_2 c \quad (5)$$

or, in other words,

$$s = (a_1 + b_1c) + (a_2 + b_2c)P . \quad (6)$$

Although only five points are available to test these hypotheses, it is noteworthy that a similar pattern exists for all eight districts. Furthermore, the form of equation (6) suggests that  $a_1$  and  $a_2$  should be approximately zero, since no storage would be required to meet a negligible consumption. With the reservations that the sample sizes ( $N = 5$ ) are small and that the usual conditions for hypothesis testing of linear regressions are not strictly met, the estimates of a yield equation in the form of (4) have  $r^2$  values between 0.995 and 0.999 for the eight rainfall districts. Similarly, the eight equations (5) for  $b$  have  $r^2$  between 0.933 and 0.999, thus, the 40 equations (3) may be generalized to eight equations (6) without loss of accuracy.

Although several of the regression coefficients,  $a_1$ , are apparently statistically significant, they are all numerically small, relative to the standard errors of regression in Table 4; seven are negative and one is positive. With minimal loss of accuracy,  $a$  can be neglected and equation (4) forced through the origin by using the following as an estimator of  $b_1$ :

$$\hat{b}_1 = \bar{a}/\bar{c} \quad (7)$$

for each of the eight districts. The coefficients  $a_2$  are generally significant, but over the range of values of  $P$  encountered in a single district, it is found that equation (5) can also be simplified as

$$\hat{b}_2 = \bar{b}/\bar{c} \quad (8)$$

without loss of accuracy. Equation (6) then reduces to

$$\hat{s} = (\hat{b}_1 + \hat{b}_2P)c , \quad (9)$$

that is, only two parameters. Although no pattern in  $\hat{b}_2$  is evident, it appears that  $\hat{b}_1$  varies spatially in a relatively smooth fashion (Fig. 3). The results are summarized in Table 5.

TABLE 5. EQUATIONS FOR SPECIFIC STORAGE VOLUME

Dis- trict	Equation (6) $\hat{s} = (a_1 + b_1c) + (a_2 + b_2c)P$	Equation (9) $\hat{s} = (\hat{b}_1 + \hat{b}_2P)c$
1	$\hat{s} = (-14.9 + 6.16c) - (0.020 + 0.0016c)P$	$\hat{s} = (5.79 - 0.0021P)c$
2	$\hat{s} = (+13.3 + 6.56c) - (0.121 + 0.0026c)P$	$\hat{s} = (6.90 - 0.0056P)c$
3	$\hat{s} = (-40.5 + 6.69c) + (0.041 - 0.0051c)P$	$\hat{s} = (5.68 - 0.0041P)c$
4	$\hat{s} = (-11.5 + 7.00c) - (0.056 + 0.0055c)P$	$\hat{s} = (6.71 - 0.0069P)c$
5	$\hat{s} = (-39.8 + 7.63c) + (0.044 - 0.0060c)P$	$\hat{s} = (6.63 - 0.0049P)c$
6	$\hat{s} = (-34.3 + 8.22c) + (0.004 - 0.0071c)P$	$\hat{s} = (7.36 - 0.0070P)c$
7	$\hat{s} = (-29.6 + 8.65c) + (0.005 - 0.0092c)P$	$\hat{s} = (7.91 - 0.0091P)c$
8	$\hat{s} = (-23.8 + 8.55c) - (0.028 + 0.0081c)P$	$\hat{s} = (7.96 - 0.0088P)c$

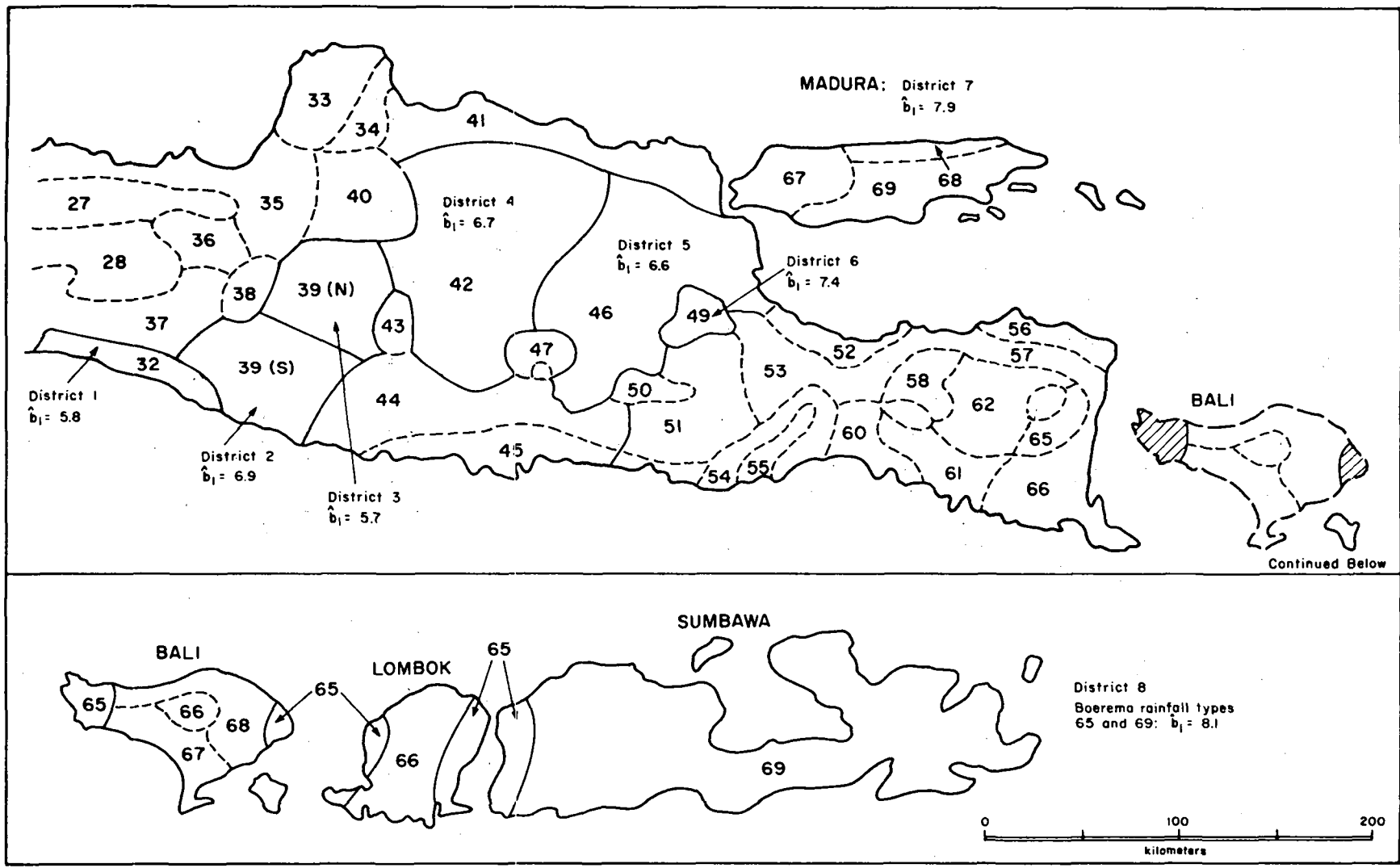

NOTE: Parameter  $b_1$  = Number of months of storage required if mean rainfall for five driest months is zero.

Figure 3. Study area, Boerema rainfall types and parameter  $b_1$ , Indonesia



A simple manual, written in the Indonesian language, has been prepared for designers at the district level. The designer locates on a map the site of P, the sum of the mean monthly rainfall for the five driest months, and of  $b_1$ . Using these two values and an appropriate value of  $b_2$  (a single value, rather than isolines, for the entire district chosen from a map), the specific storage required can be calculated for the site for a range of values of the specific consumption, c. Various trial combinations of roof area and storage volume can then be tested to find the most economical solution.

INTERPRETATION OF COEFFICIENT  $\hat{b}_1$ . If a site had zero mean monthly rainfall for the five driest months, the storage volume required would be  $\hat{b}_1 c$  mm (times the roof area, A m<sup>2</sup>), e.g.,  $\hat{b}_1 c$  l/m<sup>2</sup>, or  $\hat{b}_1$  times the consumption rate, c mm/mo; thus,  $b_1$  has dimension (month). P ranges from 125 to 800 mm throughout the study area, therefore in practice, less than  $\hat{b}_1$  months of storage is required. Even so, between three and seven months consumption needs should be stored at most sites in east Java and Nusa Tenggara if the average frequency of failures is not to exceed one year in twenty. Storage of a lesser volume not only increases the risk of emptiness, but also the risk of a prolonged shortage during a period when few alternative sources will be available.

#### OTHER CONSIDERATIONS

MONTHLY VS. DAILY ANALYSES. A study of Jakarta data (Irish 1980) indicated that the storage required to meet a given consumption for 5% frequency of failure is greater than about 0.5-mo consumption, when daily behavior analyses are performed rather than the analyses of monthly data. This amount (0.5c) should be added to the specific storage volumes determined from Table 5.

ROOF WETTING LOSSES. Despite clear instructions, different observers use different criteria for registering small amounts of rain; therefore, the statistics of mean monthly and mean annual number of rainfall days are unreliable. Buishand (19-7) showed that a shifted gamma distribution adequately fitted the daily rainfall amounts at Jakarta, and that, to a first approximation, the marginal distribution is the same for each season—the wet, dry and two transition periods. The mean rainfall per rainfall day is about 10 to 15 mm throughout Indonesia, if amounts of less than 0.5 mm are not regarded as rainfall-days (as per Instructions to Observers, Indonesian Meteorological and Geophysical Service, n.d.). The mean number of rainfall days during the five driest months ranges from about 5 to 40 in the study region, but will be less during a critical drought. About 20% of rainfall days have less than 1 mm of rain, and about 30% have less than 2 mm. If no runoff occurs for rainfall amounts of less than 2.0 mm and a 2 mm roof wetting loss is incurred during heavier falls, the difference between rainfall amounts and runoff depth will average about 1.6 mm per rain day, which is insignificant in the study area when compared to the volume of storage required.

Elsewhere in Indonesia where the seasonal pattern is less pronounced and critical periods are of several-weeks duration rather than monthly amounts is mandatory to account adequately for roof wetting losses.

SIMULATION VS. HISTORICAL DATA. The nature of the persistence in daily rainfall series is relatively complex, thus, a low-order Markov model does not adequately represent the severity of drought sequences (Buishand 1977): This

being the case, the analysis of historical data is preferred to simulation of such problems as the estimation of storage requirements for roof-runoff systems.

ALTERNATIVE SOURCES OF WATER. The results obtained indicate that approximately five months' consumption must be stored if roof-runoff systems are to be reasonably reliable in the study area. It is therefore vital that other sources be utilized wherever feasible and that consumption during the dry season be minimized. Since saline or marginally polluted sources are often available, a mass-produced, low cost solar distillation unit would help to reduce demand on the roof-runoff catchment system. The solar radiation available during the dry season is greatest in those years and at those sites experiencing the most pronounced drought, and daily exceeds 400 mWh/cm<sup>2</sup>.

#### ACKNOWLEDGMENTS

Research on which this paper is based was carried out by the second author as part of his M.Sc. studies at the Institut Pertanian Bogor, and was supported financially by the Indonesian Meteorological and Geophysical Service, which provided the rainfall data. The supervisory research committee included Mrs. R.L. Chambers (chairperson), Dr. Moersidi Soepawidjaja and the senior author. Unesco provided support for the dissemination of the results in a technical report and in a practical design manual.

#### REFERENCES

- Boerema, J. 1926. Typen van den regenval in Dederlandish-Indië (Rainfall types in the Netherlands Indies). Verhandelingen No. 18, Koninklijk Magnetisch en Meteorologisch Observatorium te Batavia, Batavia (Jakarta). (In Dutch, with extended English summary)
- Buishand, T.A. 1977. Stochastic modelling of daily rainfall sequences. Mededelingen Landbouwhogeschool Wageningen 77-3. Wageningen, Netherlands: H. Veenman & Zonen B.V.
- Buishand, T.A. 1978. Some remarks on the use of daily rainfall models. J. Hydrol. 36:295-308.
- Irish, J.L. 1980. "Concept for proposed research project on the estimation of the reliable yield from roof runoff." Unesco Regional Office for Science and Technology for Southeast Asia, Jakarta, Indonesia. (unpublished paper)
- Oldeman, L.R. 1975. An agro-climatic map of Java. Contrib. No. 17, Central Research Institute for Agriculture, Bogor, Indonesia
- Oldeman, L.R., and Sjarifuddin, D. 1977. An agroclimatic map of Sulawesi. Contrib. No. 33, Central Research Institute for Agriculture, Bogor, Indonesia.
- Oldeman, L.R.; Las, I.; and Darwis, S.N. 1979. An agroclimatic map of Sumatra. Contrib. No. 52, Central Research Institute for Agriculture,

Bogor, Indonesia.

Rippl, W. 1883. The capacity of storage reservoirs for water supply. In Proc. Inst. Civil Eng., vol. 71.

Schmidt, F.H., and Ferguson, J.H.A. 1951. Rainfall types based on wet and dry period ratios for Indonesia with Western New Guinea. Verhandelingen No. 42, Djawatan Meteorologi dan Geofisik, Kementarian Perhubungan, Djakarta, Indonesia

Sujadi. 1974. Hubungan antara meteorologi dan hidrologi (Relationship between meteorology and hydrology). Lembaga Meteorologi dan Geofisika, Jakarta, Indonesia.

## RAIN WATER AS A WATER SUPPLY SOURCE IN BERMUDA

D.H. Waller, Professor and Head  
Department of Civil Engineering  
Technical University of Nova Scotia  
Halifax, Nova Scotia  
CANADA B3J 2X4

## INTRODUCTION

Any description of rain water supply systems in Bermuda must take into account the geography and history of this small mid-Atlantic country.

The island of Bermuda is located at 32° north latitude, 65° west longitude, 917 km east of the North American coast. The "island" is actually a series of seven small islands, joined by bridges, that are the unsubmerged portion of limestone deposits, approximately 100 m from the sea floor. The aeolean limestones, laid down during glacial advances and retreats of the Pleistocene era, are loosely cemented and extremely permeable. The rock is covered by a soil layer approximately 15 cm thick.

The island is 30 km long, with a mean width of approximately 1.5 km and a maximum width of 3 km. The total area is 53.1 km<sup>2</sup>. The elevation of most of the land mass is less than 30 m above sea level, rising to a maximum of less than 100 m.

The climate is semitropical and frost free. Mean monthly temperatures approximate 20°C in winter and 30°C in summer. The average annual rainfall, based on records since 1886, is 146.8 cm (Vatcher 1974); minimum and maximum 12-month rainfalls are respectively 77.0 and 227.6 cm. Rainfall is fairly uniform during the year, but onlthly average values for April through July are lower than the annual mean.

One result of the high permeability of soil and rocks is the absence of freshwater streams and lakes. Groundwater underlies 20% of the land area, in five lens. The largest lens, with a mean thickness of 7.6 m, represents two-thirds of the total area. Brackish water (1-10% sea water) underlies another 23% of the island (Vatcher 1974).

Bermuda today is a self-governing British colony.

The island was uninhabited until its discover in 1503. It has been continuously occupied since 1609, when it was settled by English colonists who also colonized Massachusetts and Virginia in the United States.

The first Bermuda houses were similar to those in England, but construction quickly adapted to indigenous materials of cedar and limestone. Native cedar was in short supply as early as 1620, and stone buildings were encouraged, using cedar for framing and trim. The native limestone, which can be cut with a saw and which hardens on exposure to the atmosphere, was cut into blocks for walls. Roofs, supported on cedar framing, were formed of overlapping limestone slates, 30.5 cm x 45.7 cm x approximately 3.8 cm. Limestone,

burned in kilns, also provided the mortar used to assemble both walls and roofs. This form of construction is basically the same as that used today, except that concrete block walls have replaced limestone in recent construction: in 1980, 95% of households lived in houses with outer walls of limestone ("Bermuda stone") or cement block (Statistical Department 1980).

A unique feature of Bermuda roofs has been their role in water supply. Until the 1930s, rain water provided the only source of potable water. Water was collected on roofs, where wedge-shaped limestone "glides" were laid to form sloping gutters on the roof surface, diverting rain water into vertical leaders and thence into storage tanks.

Early storage tanks were rum puncheons or cisterns made of cedar. Others were formed by excavation into rock and made tight with mortar. Prior to the 20th century, tanks were located at the outside rear of dwellings, partly or entirely above ground. Water was removed from tanks by bucket or hand pump and carried indoors. In some later systems, hand pumps transferred water to elevated indoor storage tanks. Current systems include storage tanks under buildings with electric pumps and pneumatic tanks. Today, 96% of households are provided with piped indoor water supplies (Statistical Department 1980).

Rain water was also collected from "artificial catches" created by removing thin hillside soil and sealing the rock surface with mortar. Water from large artificial catches continues to provide significant quantities of water, e.g., an estimated 13.6 million l/yr from a catchment developed for a British military installation, and 45.5 million l/yr from a catchment serving a major hotel (Thomas 1980).

Roof water systems with adequate storage were not systematically encouraged until the 20th century. Prior to adoption of current public health regulations in 1951, storage capacities of 1400 to 22,000 l were common (previous public health regulations required up to 6800 l per occupant, although 13,000 l per occupant were recommended), compared with typical storage today of 68,000 l.

Water was imported from North America during a five-year period from 1938 to 1968.

In 1932 a private company, Watlington Waterworks, began development of the largest of the groundwater lenses, providing up to 3.5 million l/day of brackish water for nonpotable uses (primarily flushing) through a distribution system serving the central part of the island. Part of this water fed a desalination plant that provided potable water to several major tourist facilities. In 1979, the Bermuda Public Works Department and Watlington Waterworks commenced a joint venture aimed at rational development of the groundwater resource, involving new wells in the central lens and delivery of potable water through the Watlington system.

By the 1960s, desalination plants had been installed by several major hotels, industry, and government. At present (June 1981) a government sea water distillation plant is reaching the end of its useful life, and a brackish water reverse osmosis plant is being brought on-line, by the Public Works Department.

## POPULATION

The size and composition of the population of Bermuda is directly linked to the tourist industry because tourists make up a significant portion of those on the island at any one time and because tourism provides most of the employment opportunities that control immigration policies and net migration of the local population.

Bermuda has no natural mineral resources to form the basis of primary or a related industry. Agriculture, and support of British military and dockyard installations, maintained the economy until well into the 20th century. Bermuda was recognized as a vacation haven by those who visited by ship and, after 1938, by flying boat. During the 1930s, the government began to actively promote Bermuda as a summer tourist resort.

By the end of the second world war, the island had gained two large (5.2 km<sup>2</sup>) U.S. military installations and an international airport.

During the past several decades, a highly successful effort has been made to develop an economy based on the attractions Bermuda offers to tourists: proximity by air or ship to North America, unspoiled scenery and clean air, and excellent climate. During the 1964 to 1980 period, annual tourist arrivals increased from 188,000 to 609,600 (Tourism Department 1981).

The total population of Bermuda at any time can be divided into residents and tourists. The census classifies residents as Bermuda-born or foreign-born. Tourists can be divided into those included in the census enumeration as "Visitors and transients" and those who arrive and live on cruise boats. Visitors and transients include regular tourists identified by the Department of Tourism and other visitors. Because no recent official summary of existing and expected population is available, Table 1 has been prepared as the basis for subsequent discussion of water demands.

Projections of future populations in Table 1 anticipated a continuing decline in population growth rates and future development policies that recognize the carrying capacity of Bermuda (based on limited land area and limited amenity resources on which the economy and the quality of life for residents depend) has been or is being reached. The current gross residential population density (excluding military installations) is 1128 persons/km<sup>2</sup>, or 3401 persons/km<sup>2</sup> in residential areas.

Projections in Table 1 are based on decreases since the 1970 census in the growth of the Bermuda-born population, due to declining birth rates and net out-migration (Tourism Department 1981), and on immigration policies which are expected to reduce the foreign-born population. Future numbers of visitors and transients assume a fixed relationship between resident population and the number of visitors to whom they provide services. Numbers of cruise visitors are assumed to be limited by the number of ships that can be accommodated in Bermuda waters at one time.

Table 1 indicates, in summary, that the present resident population of 54,670 is expected to increase to 60,000 in the future, and that the annual average tourist population (including cruise visitors) is expected to increase from 9,472 to 10,350.

TABLE 1. PRESENT AND FUTURE POPULATION OF BERMUDA

	Present (1980)	Future
RESIDENTS		
Bermuda-born	40,500 <sup>1</sup>	47,000
Foreign-born	14,170 <sup>1</sup>	13,000
	54,670 <sup>1</sup>	60,000
TOURISTS		
<u>Annual Average</u>		
Visitors and Transients	8,244 <sup>1</sup>	9,050
Cruise Visitors	1,228 <sup>2</sup>	1,300
<u>Peak</u>		
Visitors and Transients	10,918 <sup>1</sup>	12,000
Cruise Visitors	2,761 <sup>3</sup>	2,800
TOTAL POPULATION		
Annual Average	64,142	70,350
Peak	68,349	74,800

<sup>1</sup>Excludes 2,173 foreign military personnel and dependents living on bases (Statistical Department 1980; census 12 May 1980).

<sup>2</sup>Based on 1980 total of 117,916 (Tourism Department 1981) and estimated mean stay of 3.8 days.

<sup>3</sup>Based on maximum monthly value in September 1980 of 22,528 (Tourism Department 1981) and estimated mean stay of 3.8 days.

#### DESIGN AND MAINTENANCE OF ROOF WATER SYSTEMS

Rain water catchment areas and storage tanks are governed by the Public Health Act of 1949 and regulations made under that Act.

The Public Health Act requires the provision of catchments and tanks for securing and storing of rain water for occupants and processes in buildings used for human habitation (including dwellings, schools, and places of work) or for manufacturing or serving of food or drink. The Act also authorizes regulations regarding the size of catchment and tanks and specifications concerning appurtenances, fittings, and ventilation.

The Plumbing and Drainage Regulations (1965) include provisions to prevent contamination of tank water as a result of defective plumbing and cess-pits (which must be at least 20 ft from a storage tank).

The Water Storage Regulations (1951) require that at least four-fifths of a roof area be adequately guttered for catching rain water, or provided with a ground catchment of equivalent size. Storage capacity of ten imperial gallons per square foot (489  $\ell/m^2$ ) of prescribed catchment area is required. Exceptions may be allowed by the Board of Health and have been granted, for example, in the case of storage for large commercial buildings with few occupants. The regulations require that tank walls and roofs be constructed of stone, concrete, or galvanized iron, except that a concrete roof is required if a tank is located under a building. Other requirements include (1) an opening of

adequate size area fitted with a tight door to permit entry and (2) adequate venting.

Present-day tanks are built in excavations under buildings, with reinforced concrete floors and roofs, and walls constructed of mortar-filled concrete blocks with an interior mortar application approximately 1.5 cm thick.

The Food Regulations (1960) specify the quality and quantity of water to be supplied to any establishment providing comestibles, and specify the minimum size of water storage for restaurants, bakeries, and manufacturers of frozen desserts and aerated waters.

The 1949 Public Health Act requires that catchments be whitewashed. Current practice is to apply white latex paint in new construction or in repainting. Compared with whitewash, latex paints are more impervious and maintain color longer. The quality of paints used for this purpose is controlled by the Department of Health to assure that they are free from metals that might leach into water supplies. Approval of paints is based on United Kingdom Toys (Safety) Regulations (1974).

The Public Health Act requires that catchments, tanks, gutters, pipes, vents, doors, and screens be kept in good repair, and that catchments be kept painted and tanks kept free of leaks. Roofs are commonly repainted every two to three years, following wire brushing and rinsing with a hypochlorite solution.

The Water Storage Regulations require that storage tanks be cleaned at least once every six years. The Public Health Act empowers the Department to require appropriate action where water in a tank appears to be polluted or in danger of pollution. Cleaning a water tank usually involves pumping out the water, removing sludge, washing with hypochlorite solution, applying a cement wash, and waiting for several days before refilling to assure that the pH is not excessively raised excessively by leaching from the cement wash.

#### CAPACITY OF ROOF WATER CISTERN SYSTEMS

The estimated number of residential roofs in Bermuda is 12,118, based on 1980 census data (Statistical Department 1980). The average residential roof catchment area has been estimated as 139.4 m<sup>2</sup> (1500 ft<sup>2</sup>), corresponding to a total area of 1.68 km<sup>2</sup>. Catchments on other roofs represent an additional 0.6 km<sup>2</sup>, and artificial catchments a further 0.14 km<sup>2</sup> (Thomas 1980). The total area of rain water catchments covers 5% of the land area of Bermuda.

Estimates of water yield from rain water catchments have varied from 66% of catchment area (W.H.O. 1975) to 80% of total roof area (Vatcher 1974). Thomas (1980) estimated that 75% of rainfall on a catchment area is recovered, allowing for losses due to evaporation following short light showers, overflows from roofs in high intensity sotrms, or overflows from storage tanks in wet periods.

The average annual water yield from a 139.4-m catchment, assuming 75% recovery from an annual rainfall of 146.8 cm, is 418 l/day. There are 8042 occupied single-family houses on the island (Statistical Department 1980), and



if they are assumed to include a mean population of 3.5 persons/house, the mean population of the remaining 10,168 households is 2.5 persons. Based on 3.5 persons/single-family house, the average annual water supply is 120 ℓ/capita/day.

The storage volume required by public health regulations (489 ℓ/m<sup>2</sup>) corresponds to 100% recovery of a 4-mo supply at the average annual rainfall rate. If it is assumed that storage corresponding to the regulations exists for all building roofs in Bermuda, the total volume of roof water storage on the island is 1.12 million m<sup>3</sup>. The significance of this storage volume becomes apparent when it is compared with the existing 0.023 million-m<sup>3</sup> capacity of government reservoirs.

The minimum required storage of 489 ℓ/m corresponds to 65.0 cm of storage on an effective catchment equal to 75% of the actual catchment area. Table 2 indicates that this storage should be adequate to supply a demand equal to 90% or more of the average supply rate of 146.8 cm/yr even in the most extreme recorded dry periods. Native Bermudians have a strong water conservation ethic, and reduced water usage during dry periods is an accepted fact of life.

TABLE 2. ADEQUACY OF BERMUDA ROOF WATER STORAGE DURING DRIEST RECORDED PERIODS

Duration (mo)	DRY PERIOD Dates <sup>1</sup>	RAIN-FALL (cm)	DEFICIT <sup>2</sup> (cm)	FRACTION OF ANN. AVG. DEMAND THAT COULD BE MET <sup>3</sup>
12	06/1910-05/1911	79.5	67.3	0.98
24	06/1910-05/1912 (10/1974-09/1976)	205.5 (231.9)	88.1	0.92
36	06/1910-05/1913 (11/1973-10/1976)	322.6 (354.3)	117.9	0.88
48	01/1952-12/1955	476.3	115.6	0.91

<sup>1</sup>Historical data from Macky (1951); supplementary data from Vatcher (1974) and W.H.O. (1975); and records maintained by Department of Agriculture and Fisheries.

<sup>2</sup>Compared with annual average rainfall of 146.8 cm.

<sup>3</sup>Based on 65-cm storage, assuming demand equal to annual average rainfall.

The foregoing discussion applies to an average house. In fact, many older houses have considerably smaller storage than required by present regulations, some single-family homes have greater than average population, and multiple-family buildings have smaller storage relative to numbers of occupants. Water shortages therefore occur even in periods of normal rainfall, requiring that supplementary water be added to storage tanks from other sources.

No systematic measurements of water demands in houses supplied with roof water have been made, and demand must be inferred from estimates of the amount and distribution of water supplies. Because a small part of the supply to residents is derived from sources other than roofs and because it is difficult to divide water from these sources into residential and other uses, it has

been assumed, in developing the overall water balance that is presented in Table 3, that the total demand of the resident population is 109 l/capita/day. This may be compared with the total supply available from residential catchments, which corresponds to 95 l/capita/day.

Other estimates of residential usage, based on interpretations of information about rainfall, catchment area, effective catch, and precipitation, have ranged from 101 l/capita/day (WHO 1975) to 136 l/capita/day (Vatcher 1974).

#### WATER QUALITY IN ROOF WATER SYSTEMS

The Bermuda Department of Health is satisfied that the quality of water from rain water cistern systems is adequate, if these systems are properly installed and maintained. Roof water has served Bermudians for over 300 years with no record of water-related illness, and is consumed by tourists and visitors from many other parts of the world with no reported ill effects.

Where water quality problems have been encountered, they are related to defects in systems or failure to adequately maintain them. Moss will grow on roofs that are not cleaned every two or three years; flies will lay eggs in the moss, and fly larvae are washed into storage tanks. Water supplied by truck during a dry period is occasionally contaminated at the source or in transport. This occurs when a builder fills the transport tank with non-potable water for construction purposes, and later does not empty and disinfect it before filling it with potable water. Bird droppings are not normally a problem because the wide variety of birds that are native to Bermuda appear content to roost on trees or wires. Pigeons kept by fanciers are a cause for concern, however, because they tend to roost on neighboring houses and are a potential source of salmonella. Insects (especially cockroaches), birds, and animals (especially frogs), which may enter tanks through defective screens or covers, are potential carriers of disease and sources of taste and odors if they die and decompose in tanks. Occasional problems have been created by defective plumbing when drains were installed over existing roof surfaces and leaked onto roofs, or when the potable water system was cross-connected with a nonpotable flushing supply.

Most Bermuda roofs are located above surrounding vegetation, and the configurations of the roof water catches, with the assistance of the wind, appears to keep roofs clear of leaves and debris. The tall Casuarina trees are an exception; if these trees are not trimmed, their fine needles will easily pass through screened openings into roof water leaders, and decompose to create taste and odor problems and a highly organic water environment in which coliform counts can increase.

If newly painted roofs are not allowed to dry and harden completely before the first rainfall, materials leached from paints can produce highly alkaline water that causes skin irritations, and the contents of the storage tanks must be wasted. The Health Department therefore recommends that water from the first shower on a newly completed roof be allowed to discharge to waste.

Bermuda is fortunate in its extremely clear air, unaffected by local in-

TABLE 3. ESTIMATED PRESENT AND FUTURE SUPPLY AND DEMAND  
FOR POTABLE WATER IN BERMUDA

	PRESENT		FUTURE	
	Mean -----(m <sup>3</sup> /day)----	Peak	Mean ------(m <sup>3</sup> /day)-----	Peak
<b>SUPPLY</b>				
Groundwater				
Public Supply	3 065 <sup>a</sup>	4 635	6 450 <sup>a,b</sup>	8 725 <sup>a,b</sup>
Private Licensed Wells	225	365	225	365
Desalination				
Public <sup>1</sup>	70	490	-----	-----
Private	1 635	2 180	1 635	2 180
Roof Water Cisterns				
Residential <sup>2</sup>	5 135	3 180	5 630	3 495
Hotel	365	365	365	365
Public	65	65	65	65
Other <sup>3</sup>	--	680	--	680
	<u>10 560</u>	<u>11 960</u>	<u>14 370</u>	<u>15 875</u>
<b>TRANSPORT</b>				
Private Pipeline	845	1 045	845	1 045
PWD/WWD <sup>4</sup> Distribution	2 255	3 865	5 545	7 460
Trucks	320	1 320	320	1 320
On-Site Supply				
Desalination	1 640	2 185	1 640	2 185
Cistern Storage	5 540	3 545	6 020	3 865
	<u>10 560</u>	<u>11 960</u>	<u>14 370</u>	<u>15 875</u>
<b>DEMAND</b>				
Tourist <sup>5</sup>	3 370	4 500	3 680	4 910
Cruise <sup>6</sup>	90	275	90	275
Residents <sup>7</sup>	6 050	6 045	9 550	9 550
Losses <sup>8</sup>	1 050	1 140	1 050	1 140
	<u>10 560</u>	<u>11 960</u>	<u>14 370</u>	<u>15 875</u>

<sup>a</sup>Includes 845 m<sup>3</sup>/day (mean) 1 045 m<sup>3</sup>/day (peak) of brackish water piped to private electro-dialysis plant for distribution to hotels.

<sup>b</sup>Includes 1 135 m<sup>3</sup>/day of brackish water treated in new (1981) PWD reverse osmosis plant.

<sup>1</sup>Present PWD sea water distillation plant assumed phased out in future.

<sup>2</sup>Residential supply assumed to be reduced in dry period, when smaller tanks empty unless supplied by truck. Future residential supply assumed increased in proportion to estimated resident population increase.

<sup>3</sup>Cisterns in non-residential and non-tourist buildings are assumed to be used only in dry periods to supply truckers.

<sup>4</sup>Public Works Department/Watlington Water Works distribution system.

<sup>5</sup>Tourist demands based on 409 l/capita/day, present population of 8244 (mean), 10,910 (peak), and future population of 9,050 (mean), 12,000 (peak).

<sup>6</sup>Cruise passenger demand assumed at 91 l/capita/day, with present numbers 1128 (mean) and 2761 (peak), and future numbers 1300 (mean) and 2800 (peak).

<sup>7</sup>Resident demand based on present population of 54,670 and mean demand of 109 l/capita/day, and future population of 60,000 and mean demand of 159 l/capita/day. Includes commercial, industrial and public use for resident population.

<sup>8</sup>Losses include 910 l/capita/day estimated loss from PWDWWD distribution system, plus reject water from electro-dialysis plant.

dustrial discharges. Current studies by the Bermuda Biological Station on the long-range transport of air pollutants are expected to verify that metals and organics from this source are not a threat to roof water quality.

Aerial spraying of chemicals was considered a threat to roof water quality in 1940 when a blight struck the Bermuda cedar, and spraying was proposed and rejected.

Samples of cistern water are taken when suspected water-related illness is reported to verify that remedial measures (usually cleaning of a tank and/or roof) have been successful. Typical results include total coliform counts equal to or less than 2 or 3/100 mL, zero E. coli counts, chloride (as NaCl) 50 to 80 mg/L, and hardness (as CaCO<sub>3</sub>) 50 to 80 mg/L.

#### CONTRIBUTION OF ROOF WATER TO TOTAL SUPPLY

Table 3 attempts to represent a potable water balance for Bermuda for existing and future mean and peak flows. The values in Table 3 exclude major military establishments on the island, which are self-sufficient by virtue of water catches and sea-water distillation plants.

Peak demands in Table 3 represent maximum summer tourist demands coincident with a dry period during which all sources and transport systems are in operation at peak capacity. Residential roof water supplies in peak periods are assumed to be severely reduced because stored water is exhausted in many households and trucked supplies are required. Residential demands in peak periods are assumed unchanged from average rates, although in fact they would decrease by an unknown amount due to household water conservation. Lawn irrigation is not expected to increase demands during peak periods because the amount of water used for this purpose is insignificant. Home gardens may be watered from rain water storage tanks, but this practice is highly unlikely in periods of household water shortage.

Future roof water supplies are assumed to increase in proportion to the growth in resident population. Table 3 assumes that with time Bermudians will increase their water demands by greater use of water-consuming appliances common in North America. An estimated future demand of 159 L/capita/day proposed in a World Health Organization (1975) report, has been used in Table 3. This value is consistent with the mean demand of 164 L/capita/day in a largely single-family residential of Halifax, Canada, in which water used for lawn irrigation is insignificant.

Table 3 indicates that roof water cisterns supply about one-half of total water consumed in Bermuda, and 85% of the demand by residents. If water from this source were not available, the only option would be desalination. The estimated total yield of all potable groundwater lenses is 8 000 m<sup>3</sup>/day in a wet period and 6 437 m<sup>3</sup>/day in a period of drought (Thomas 1980). It can be seen from Table 3 that future groundwater demands could equal or exceed these values.

Table 3 also indicates the impact of roof water systems on modes of potable water transport on the island. A water distribution system, consisting of 51 km of pipes ranging in size from 5 to 40 cm, covers only part of the

central portion of the island. Although the 30 licensed water trucks transport only a small portion of the total demand, they play a critical role in peak periods.

The Public Works Department has under consideration a number of proposals (not reflected in Table 3), that would significantly reduce demands on the public system. An estimated 460 m<sup>3</sup>/day can be saved by reducing distribution system losses. An estimated 910 m<sup>3</sup>/day of potable water from the public system is estimated to be used for flushing. A substantial portion of this demand could be met if a proposed salt water flushing system is installed in the city of Hamilton. It is also proposed to encourage use of private salt or brackish water wells for flushing. Approximately 2,000 such wells now exist on the island.

#### ACKNOWLEDGMENTS

The information on which this paper is based was obtained with the cooperation and assistance of the Bermuda Departments of Agriculture and Fisheries, Public Works, Public Health, Tourism, and Statistics, the Bermuda Biological Station, and many individual Bermudians. The author accepts responsibility for interpretation of information obtained from these sources.

#### REFERENCES

- Macky, W.A. 1951. The rainfall of Bermuda. Tech. Note No. 8, Bermuda Meteorological Office.
- Statistical Department. 1980. Report of the population census. Bermuda Government.
- Thomas, E.N. 1980. The artificial and roof rainwater catches of Bermuda. Bermuda Public Works Department.
- Tourism Department. 1981. Tourist arrivals. Bermuda Government.
- Vatcher, H.L. 1974. Groundwater hydrology of Bermuda. Bermuda Public Works Department.
- World Health Organization. 1975. Water supply and sewerage sector study.

RAIN WATER COLLECTION AND UTILIZATION  
AT TAMIL NADU AGRICULTURAL UNIVERSITY, COIMBATORE, INDIA

R.K. Sivanappan, Professor and Dean  
College of Agricultural Engineering  
Tamil Nadu Agricultural University  
Coimbatore 641 003, INDIA

INTRODUCTION

"As free as the land, air and water" is an age-old expression, which men have used for hundreds of years to signify the things that nature has bountifully provided, as contrasted to the type of wealth that has a tangible value, usually as a result of human efforts in reworking natural elements. But today the old phrase is largely empty. It has lost most of its original significance and at present water has become such a scarce resource that it is called "Liquid Gold" in many parts of the world, especially in the Coimbatore District of Tamil Nadu, India. It is needless to say that man simply cannot live without water. He must have it to drink, to meet domestic needs, to raise crops and to cooperate his manufacturing industries. And the demand for water is steadily increasing as civilization becomes more and more industrialized.

The place of water in the agricultural and in the overall economy is clearly established. It is indispensable to any form of life and action. It can be man's greatest friend or one of his most destructive enemies. Under control, it performs a host of vital tasks in addition to achieving its final and supreme purpose in providing man with a resource necessary to life itself. Uncontrolled, it wreaks havoc with floods and carries our most precious top soil out to sea.

Taking all these elements into account and in looking to the future to 2000 A.D. and beyond, we must carefully plan and harness every drop of available water in the dry areas. If we should fail to act now, with intelligence and decision, we would place our children in a position of deadly peril. There are several avenues of approach and all of them must be explored and used to the fullest practicable extent. One technique among these is water harvesting.

NEED FOR WATER HARVESTING IN INDIA AND TAMIL NADU STATE

The basic source of water available for agriculture, industries, or for human/animal consumption is rainfall precipitation, which is erratic in nature and poorly distributed. The annual rainfall range varies from 2 000 mm in one region to 100 mm in some other regions. In India, the average rainfall is 1 150 mm. If the entire precipitation is properly utilized, then there would be no need for any other water conservation measures; and if the rainfall were well distributed in time and space throughout India, there would be no problems of floods and droughts. Unfortunately, that is not the case. Of the total annual precipitation of  $4 \times 10^8$  ha-m, about  $1.55 \times 10^8$  ha-m flows as surface runoff; the rest percolates into the ground and is lost by evapotranspiration. Because of this, only 30% of cultivated areas is at present irri-

gated in India. With the growing population and reduction in the per capita land under cultivation, the pressure on land for growing more and more produce is mounting. Water harvesting techniques are thus of utmost importance in this context and in the present time.

Tamil Nadu State has a land area of 13 million ha, and its average annual rainfall is 950 mm. The per capita availability of water is about 860 m<sup>3</sup> for Tamil Nadu, whereas, it is 5 600 m<sup>3</sup> for the entire country. The per capita farmed in Tamil Nadu is only about 0.15 ha compared to the all India average of 0.26 ha. In Tamil Nadu, 46% of the area is under irrigation. Currently, the domestic and industrial uses of water are about 10% of the available resources, which is a share that is likely to be about 20 to 25% in 2000 A.D. with increased industrialization, urbanization, and growing needs of rural areas for improved facilities for drinking water in the future. Since readily available water sources are tapped to the maximum, the demand for the future poses serious problems. Thus, the short-term measure, such as the water harvesting process, will play an effective role in the conservation of water for Tamil Nadu.

### ROOF WATER COLLECTION AT TNAU

Collecting rain water on land surfaces is not a new idea. Our forefathers constructed large numbers of tanks and lakes to collect excessively flowing rain water. At present, there are about 0.5 million tanks and ponds that irrigate a total area of 4.5 million ha in India. Small-sized cisterns and rain barrels are still used to store runoff water from roof tops by many urban and rural families in India; however, as modern agricultural and municipal water supply systems have been developed, these old practices are not being followed. Roof-top water collection has many advantages in urban and low rainfall areas. The vitality, utility, and conservation of rain water catchment on roof tops is the focal point of research studies at Tamil Nadu Agricultural University (TNAU) in Coimbatore.

At the TNAU Coimbatore campus, large buildings provide sizeable roof-top areas for the collection of rainfall. Although the rainfall at Coimbatore is infrequent, when it rains there is considerable runoff because of high-intensity rainfall. Ten millimeters of rain yields one lakh l (100 m<sup>3</sup>) of water when collected from a 10 000-m<sup>2</sup> area. By harvesting this rain water from roof tops, laboratories are provided with supplies of salt-free water for distillation and other experimental works. In addition, the excess water is also used for gardening, irrigating lawns, and for water closets.

### LOCATION AND DETAILS OF RAIN WATER TANKS

When the Research Institute building was constructed during 1907, two rain water tanks on both sides of the building were installed to collect water from its roof. Subsequently, when Freeman Building was constructed in 1920, the rain water was collected in two underground sumps in the open quadrangles inside the building. When the Golden Jubilee and Post-Graduate Blocks were taken up during 1960, arrangements were made to collect the roof water in the existing rain water tanks of the Research Institute building. A separate underground circular sump was constructed for the Ramaswami Sivan Block. Thus,

whenever new buildings are constructed at TNAU, provisions are made to collect and store rain water for use in laboratories and water closets. The recently constructed Agricultural Engineering and Library buildings have been fully connected with a network of underground pipelines and sump arrangements. The cistern underground store tanks have been constructed with asbestos/RCC cover to avoid the formation of algae due to the penetration of the sun's rays and to keep the water clean from foreign material. The cost of the tank depends upon the year of construction and the roof area, and varies from Rs.10,000 to 25,000 (\$1250-3200), depending upon the tank capacity. All the underground cisterns are provided with overflow arrangements. Any excess flow from the tanks is transported through open drains to the recharge wells. By this arrangement, more than 85% of the rainfall collected on roofs can be used for useful purposes on this campus. The roof area of the buildings and the capacities of the rain water tanks are given in Table 1.

TABLE 1. DETAILS OF ROOF AREA AND CAPACITIES OF RAIN WATER TANKS FOR TNAU MAIN BUILDINGS, COIMBATORE, INDIA

S. No.	Name of Building	Contributing Area to Water Tank	Non-contributing	Total Area of Bldg.	Water Tank Capacity
			Area to Water Tank		
1.	Research Institute	1 620	1 440	3 060	405.50*
2.	Golden Jubilee	1 907	1 440	3 351	
3.	Post-Graduate	1 571	1 550	3 121	
4.	Ramaswamisivan (2 quadrangles)	1 571 900	1 550	3 121	344.00
5.	Freeman	1 874	1 725	3 599	937.20†
6.	Agricultural Engrg. College	1 600	270	1 870	126.00
7.	University Library	1 950	250	1 700	267.00‡
8.	Workshop buildings				202.00§
	Soil & Water	929	186	1 115	
	Farm Power	929	186	1 115	
	Agricultural Processing	929	186	1 115	

\*Two 202.75 m<sup>3</sup> tanks.

†Two 468.60 m<sup>3</sup> tanks.

‡Two tanks.

§Ground level reservoir.

A special arrangement is made to collect rain water from roofs of three workshop buildings. The roofing material is of cabled-type, asbestos sheets. Each building has three main gutters, both ends of which are connected to 15 cm diameter asbestos pipes that lead to the ground-level reservoir through underground pipelines. The multipurpose ground level reservoir is also used to store well water pumped from the nearby bore well for irrigation purposes. All these drain systems are provided with junction boxes, silt traps, and screens at the required places to avoid clogging due to silt and other foreign



materials coming from the roof tops. Except for the workshop roofs, all the other building roofs are provided with pucca weathering course with flat tiles fixed on top. By this arrangement, it is possible to maintain the runoff coefficient which varies from 0.85 to 0.95.

Because the buildings have varying roof heights, the rain water from all roof areas could not be collected. The flow from noncontributing portions is collected by baffled surface entry traps which divert the flow to storm water drains and, ultimately, to the recharge wells. A plan showing the various buildings, underground pipelines, storm water drain, and recharge well is shown in Figure 1.

#### QUANTITY OF RAIN WATER COLLECTED AND REQUIREMENT FOR LABORATORIES

The average annual rainfall of Coimbatore is about 630 mm. The maximum rainfall normally occurs during October, November, and December due to the northeast monsoon and in May, June, and July in less quantum by the southwest monsoon. In the remaining periods, rain water collection is not significant. Thus, the water collected in the southwest monsoon period is used during August and September and again stored during the northeast monsoon period for use during the dry seasons.

The total roof area contributing to the existing rain water tanks is 15 800 m<sup>3</sup>. In a normal year of rainfall of 600 mm, the total rainfall precipitation collected would be around  $9.4 \times 10^{-6}$  m<sup>3</sup>. In 1979, a record amount of about  $9.0 \times 10^{-6}$  m<sup>3</sup> was collected. In 1980 during the southwest monsoon period, the intensity of rainfall was very low. In the northeast monsoon, a total of 250 mm of rainfall was received and only about  $3.75 \times 10^{-6}$  m<sup>3</sup> was collected in all the tanks put together. In Table 2 the quantum of rainfall to fill each tank and the expected number of fillings in a normal rain year are given. The runoff and rainfall relationship details are given in Figure 2 for the different rain water collection tanks housed in the respective buildings.

Because the major portion of soil in this area is black soil, water in most of the wells has more dissolved salts that are harmful to certain crops and unfit for laboratory use and distillation works. The electrical conductivity (EC) of Coimbatore water varies from 2 to 6 mmhos/cm with moderate levels of sodium adsorption ratio (SAR) and low boron content. Thus, the well water cannot be directly utilized without preprocessing for various purposes in the laboratories, greenhouses, mist chambers, and pot culture houses. But, as an effective alternative, the roof water collected can be directly utilized. Nearly 1 000 m<sup>3</sup> (1 million ℓ) of rain water are required for laboratory work on this campus; and the daily demand rate varies from 3.0 to 3.5 m<sup>3</sup> (3000-3500 ℓ). The water requirements for various laboratories are given in Table 3. Further, the roof water collected is also used for cleaning wash basins, producing distilled water for experimental laboratory use, preparing spray fluids, providing irrigation for lawns and greenhouse plants, and for water closets.

#### TNAU HAND PUMP

To withdraw rain water from storage tanks to water carts, TNAU scientists

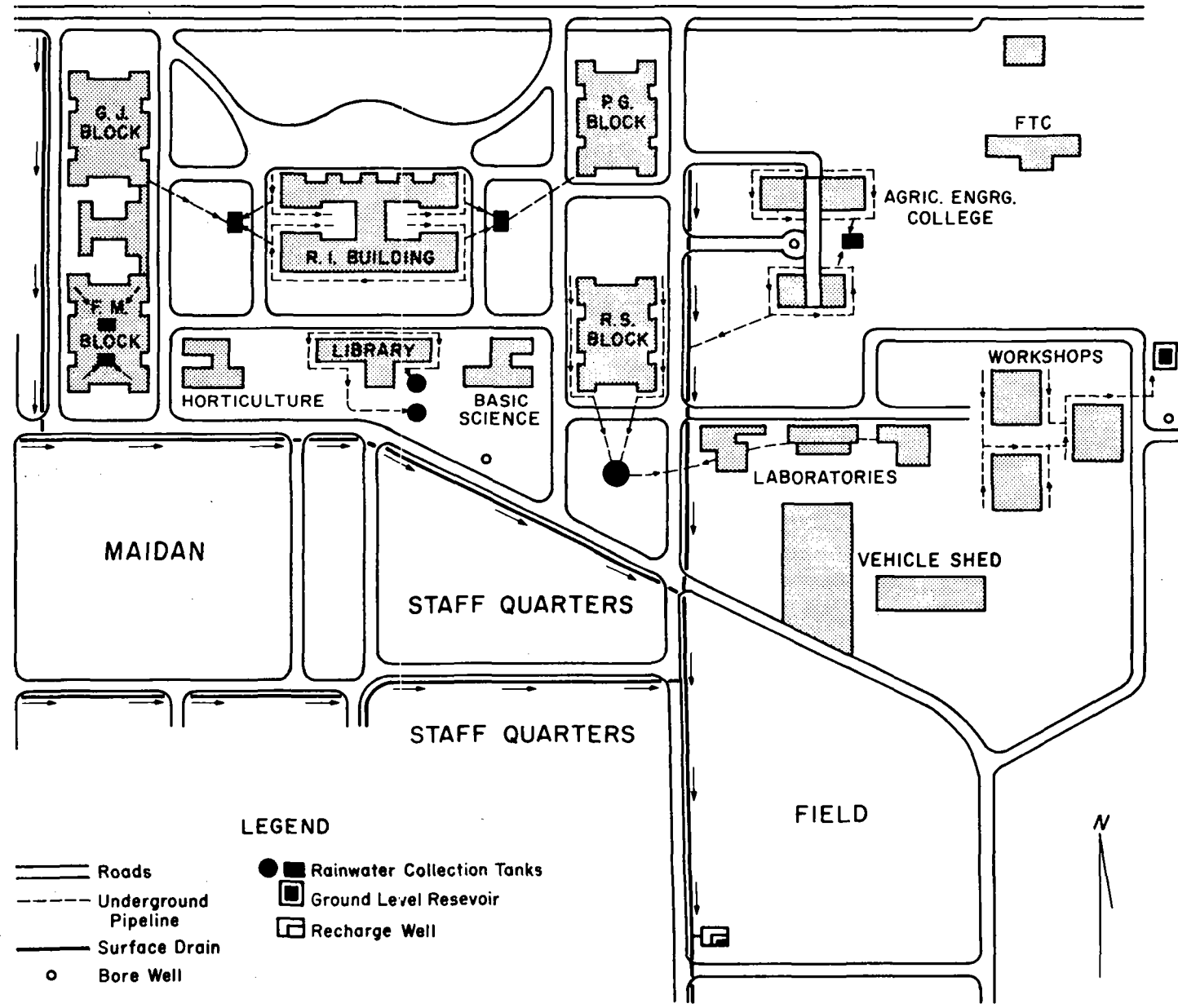

Figure 1. Rain water tanks location

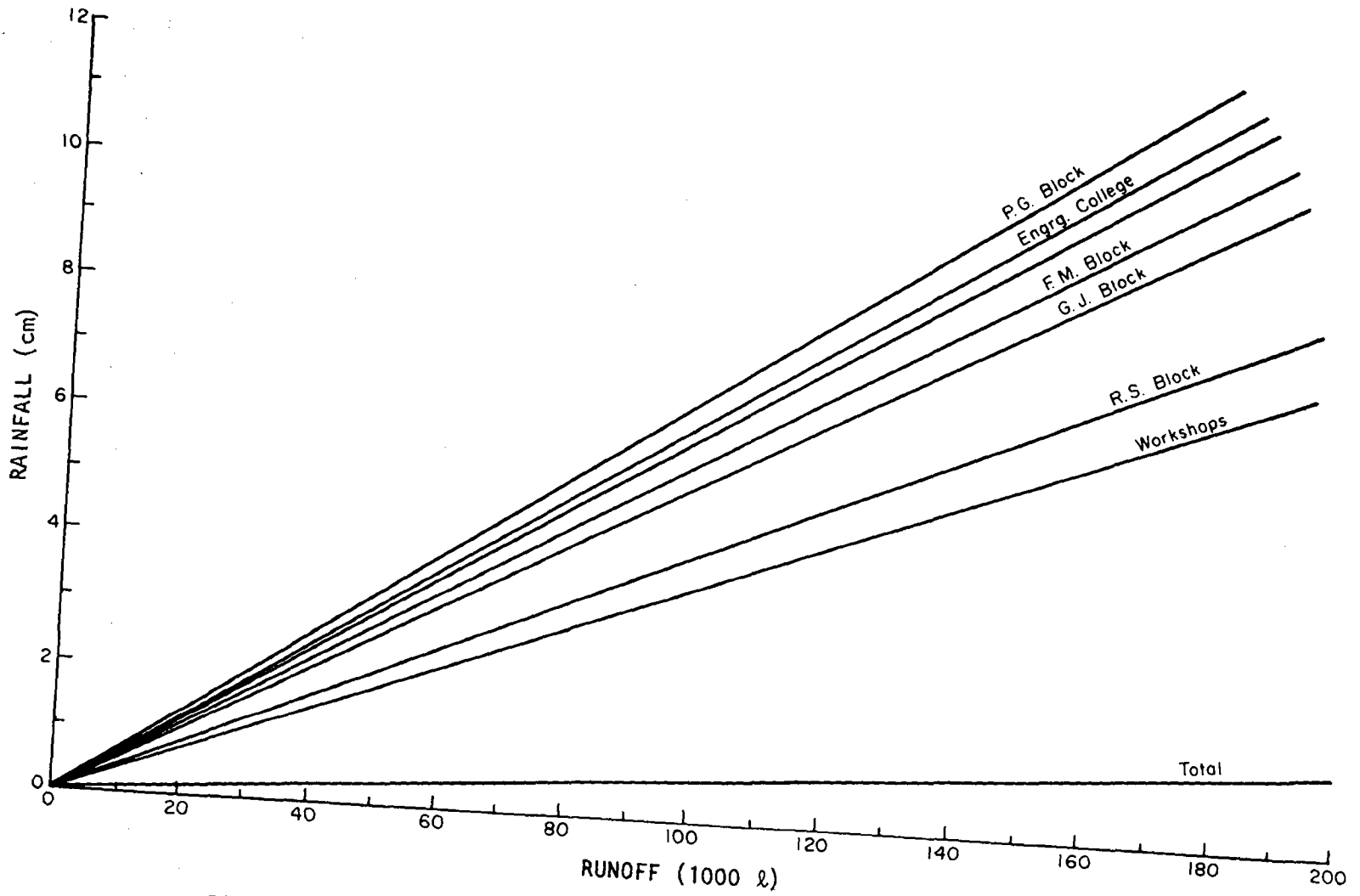

Figure 2. Rainfall-roof top runoff relationship for various buildings

TABLE 2. RAIN WATER TANK CAPACITY, AMOUNT OF RAINFALL REQUIRED, AND NUMBER OF FILLINGS PER YEAR, TNAU, COIMBATORE, INDIA

S. No.	Rain Water Tank Location	Tank Capacity (m <sup>3</sup> )	Cumulative Rainfall to Fill Tank (mm)	Fillings Expected in Normal Year (no.)
1.	Freeman Building	937.20	520.1	1
2.	Research Institute Building (West)	202.75	75.0	8
3.	Research Institute Building (East)	202.75	120.0	5
4.	Ramaswamisivan Block	344.00	140.0	4
5.	Workshop Buildings	202.00	90.0	5-6
6.	Agricultural Engineering College	126.00	80.0	6-7
7.	University Library	267.00	120.0	5

TABLE 3. RAIN WATER DEPARTMENTAL REQUIREMENTS FOR DISTILLATION AND LABORATORY USE, TNAU, COIMBATORE, INDIA

S. No.	Department	Water Required (m <sup>3</sup> /yr)
1.	Soil Science	337.50
2.	Agronomy	36.50
3.	Agricultural Botany	50.00
4.	Plant Physiology	5.00
5.	Plant Pathology	105.00
6.	Entomology	60.00
7.	Microbiology	300.00
8.	Horticulture	22.50
9.	Pesticide Testing, Radio Isotope, and Sericulture	83.50

have developed a low-cost hand pump. The pump consists of a 90 mm O.D. PVC pipe which extends into the water table and a piston with two aluminum rings and chrome leather rings to form a seal. A one-way valve is attached to the bottom of the piston. Two pieces of 25 x 3 mm angle irons form a square hand grip for an 1 800 mm long pump handle. A hinge forms a fulcrum at one end of the handle 600 mm from where the piston is attached by 12.5 mm diameter pipes.

A galvanized iron, 75 mm diameter x 750 mm long delivery pipe coupled to the pump cylinder has a water outlet 200 mm from the top. The maximum lift of

the pump is 8 m. For water tables up to 8 m from the ground level, the piston and cylinder can be kept at ground level. For lower water tables, the cylinder has to be lowered so that the water level is within 8 m from the cylinder. The pump is fixed on wooden planks in the well. The pump can be easily manufactured, installed, and handled. The discharging capacity is in the range of 4.7 to 4.9 m<sup>3</sup>/hr. The cost is approximately Rs.450 (\$50).

### CONCLUSION

Because water is a scarce resource, rain water collection on roof tops of the TNAU campus buildings provide the grade and quality of water needed for the laboratories. Construction of underground reservoirs to store the rain water from roofs was thought of as early as 1907, and the same collection method is used today whenever new buildings are added on this campus. Roof water is regularly collected and stored in underground reservoirs of varying capacity. The water thus collected is withdrawn by a centrifugal hand pump for laboratory experimental cultures and irrigation purposes. Although the construction cost for a storage tank may be high, the cost is balanced in view of the availability and quality of water provided for the needs of the campus. Since the demand for water in desirable quality increases continually on campus, it is recommended that all institutions, organizations, hospitals, and private entrepreneurs will practice, to the fullest extent possible, the collection of rain water on roof tops, and to use any excess water for recharge purposes.



Rain water collection tank with provision for pump-set installation, including overhead tank for distribution to laboratory

## RAIN WATER AS AN ALTERNATIVE SOURCE IN NOVA SCOTIA

D.H. Waller, Professor and Head  
Department of Civil Engineering  
Technical University of Nova Scotia  
Halifax, Nova Scotia  
CANADA B3J 2X4

D.V. Inman, Supervising Engineer  
Pipeline Engineering  
Nova an Alberta Corporation  
Calgary, Alberta  
CANADA T2P 2N6

## INTRODUCTION

The Canadian province of Nova Scotia includes a population of 856,600 persons in an area of 52,840 km<sup>2</sup>. Approximately one-half of this population is served by municipal water distribution systems. Most of the remainder are served by private wells. Groundwater in some parts of the province is inadequate in quantity, or is made undesirable or completely unacceptable for domestic uses because of excessive mineral concentrations.

Arsenic and uranium have recently been added to a list of natural contaminants that includes iron, manganese, and hardness. In one small municipality, 294 wells were tested for arsenic. Arsenic concentrations exceeded 0.01 mg/l in water from 130 wells of which 51 had concentrations greater than 0.05 mg/l (Division of Public Health Engineering 1979), compared with a recommended objective concentration equal to or less than 0.005 mg/l and a maximum acceptable level of 0.05 mg/l (Health and Welfare Canada 1978).

In another area, water in 101 of 299 wells tested for uranium contained an excess of the maximum acceptable concentration of 0.02 mg/l, and water in a further 58 wells contained concentrations between 0.01 and 0.02 mg/l (Bower 1981).

For many years, rain water collected on roofs has served as a complete or a supplementary domestic water source in parts of Nova Scotia where water quantity or quality is inadequate, but no documented evidence of roof water systems was available. In 1977, the authors undertook an exploratory study of roof water use in Nova Scotia. The study was initiated with a newspaper enquiry and followed by a questionnaire, personal interviews, limited water quality analysis and analysis of precipitation data.

## SURVEY OF ROOF WATER SYSTEMS

A letter to the editor of a provincial daily newspaper in February 1977 requested information from readers about roof water systems in the province. A total of 48 responses was received, including 26 replies from current users of roof water; the remaining replies referred to systems previously used by, or known to, the respondents in Nova Scotia or elsewhere in North America, Bermuda, or Europe.

Of the 26 current users of roof water, 20 live in three geographical areas of the province, and their comments indicate that their replies were representative of many others in their respective communities. The other users, distributed across the province, apparently represent isolated prob-

lems. A number of the other respondents referred to roof wazer systems supplying Transport Canada lighthouse structures; subsequent inquiries added information about these systems.

Twenty-three of those using roof water responded to a questionnaire that provided supplementary information. Their replies are regarded by the authors as a representative sample of those using roof water in the province; for example, one of these responses describes a system that is common to all lighthouses on the Nova Scotia coast.

At one time, 65 to 70 keeper's houses at Transport Canada lighthouses were served by rain water from roofs. The number has decreased because of automation, which reduced the number of lighthouses, and because roof water has been replaced, where feasible, with groundwater where roof water systems cannot satisfy normal household demands. Roof water now supplies 33 systems, about half the total number of existing lighthouses. In the long run this number is expected to decline to about 15 lighthouses, which cannot be automated because of their remote location, for which no other water supply is available. No new system has been built since 1978.

Table 1 lists the reasons why roof water is used and the uses to which it is put. Many wells yielding hard water are located in areas underlain by gypsum deposits, which yield water unsuitable for any use. All of those who depend on roof water (i.e., who have no alternative except trucked water) reported shortages in dry periods or in the summer. Only one of those with an alternative supply indicated that their roof water supply was

TABLE 1. USE OF ROOF WATER

Reason for Roof Water Use	
Poor quality of well water .....	3
Minerals in well water .....	1
Minerals and iron in well water .....	3
Hardness in well water .....	6
Prefer for washing .....	1
Quality and quantity of well water inadequate .....	6
Quantity of well water inadequate .....	1
No other source available .....	1
Cheaper and less subject to interruption than available municipal source .....	<u>1</u>
	23
Use of Roof Water	
All purposes .....	10
All purposes except drinking and cooking .....	10
Drinking (after boiling), washing .....	1
Cooking, washing (not drinking or flushing) .....	1
Washing only .....	<u>1</u>
	23
Available Supplementary Water Source	
None (Transport Canada lighthouses) .....	1
Trucked water .....	5
Well water .....	16
River water .....	<u>1</u>
	23

## CHARACTERISTICS OF SYSTEMS

Twenty-three systems serve households of one to seven persons, with an average of four persons per household.

All of the roofs are covered with asphalt shingles; there is no indication that any special features were included to collect roof water. Roof areas vary from 84 to 316 m<sup>2</sup>; areas of roofs of the five dwellings with no alternative supply range from 93 to 163 m<sup>2</sup>. Transport Canada standard plans for lighthouse keeper's residences provide roof areas of 111 m<sup>2</sup>; older plans require 68 m<sup>2</sup>. Storage capacities range from 4546 to 47,733 litres; storage capacities for dwellings with no alternative supply are 4546 to 27,276 litres. In two cases, roof water is directed into a well which provides storage for a combined roof water/groundwater system. Transport Canada systems require a two-compartment tank of 14,150-l capacity.

Transport Canada lighthouses include removal threaded plugs at the base of roof leaders to allow the first flush of roof water to be wasted. One other house includes a similar arrangement. Another house includes a slowly draining container that collects and wastes the initial discharge, then discharge the subsequent flow into the storage tank. No other respondent indicated that his system was designed to waste initial storm runoff.

Table 2 summarizes the treatment of roof water for 23 dwellings. Only one uses untreated roof water for drinking. Six use some kind of filter. Standard Transport Canada plans require a charcoal-sand filter. Three use disinfection: two by occasional application of hypochlorite, the other by chlorinator.

TABLE 2. ROOF WATER TREATMENT

Used for Drinking (Unboiled)	
Charcoal filter plus chlorinator .....	1
Occasional hypochlorite in tank	
Plus sand filter .....	1
Plus commercial cartridge unit .....	1
No other treatment .....	1
Filter only	
Commercial cartridge unit .....	1
Charcoal-sand .....	1
Silica sand brick .....	1
Sand .....	1
Gravel .....	1
No treatment .....	1
Used for Drinking (Boiled) .....	1
Used for Other Purposes (No Treatment) .....	<u>12</u>
	23

## MAINTENANCE OF SYSTEMS

One respondent indicated that the roof was cleaned annually, and another



that occasional cleaning was practiced; however, examination of their answers suggests that they may refer to cleaning of gutters. None of the other 19 roofs is cleaned except by rainfall. The design of systems at Transport Canada lighthouses requires that keepers remove threaded plugs at the base of each roof leader at the beginning of each storm for a period of 5 to 20 minutes, primarily to wash salt from roofs, but also to remove bird droppings and other debris. When tanks are full, the same plugs are left out to waste excess water. The owner of the other house that is similarly equipped removes the plugs "as necessary to clean the roof".

Pine needles are a problem to one householder because they pass through screens and accumulate in storage. Leaves are of concern to 13 others because they block gutters. Nine respondents indicated that gutters are cleaned regularly, and one noted that trees near the house were trimmed. One of the respondents to the newspaper inquiry, who no longer uses roof water, gave as a reason tastes attributed to seagull droppings on the roof.

Fifteen persons regularly clean their storage tanks at intervals of once per year (five persons) to eight times per year (one person). Five tanks have not been cleaned, and one respondent did not answer the question. Transport Canada recommends that storage tanks be cleaned every year or two, but lighthouse keepers decide how frequently cleaning of individual systems is required. Cleaning usually involves draining the tank, sweeping or scrubbing as necessary, and rinsing with water and possibly hypochloride solution. The charcoal-sand filter systems apparently receive little, if any, attention.

The only other maintenance reported was annual replacement of cartridges in filters in the two households that used them, and an annual replacement of the top layer of sand in one sand filter.

Only two respondents to the questionnaire reported problems with their systems. One complained that the storage tank made their basement damp, another that the tank leaked until it was sealed with a cement wash. Leakage has been a problem with cisterns in some Transport Canada houses. Custom-made vinyl pool liners have been used to line defective tanks, which are refilled by water transported by ships.

#### ROOF WATER QUALITY

A number of fresh, roof water samples were obtained from rain water leaders at the Technical University of Nova Scotia, three of them at intervals during a single event. One sample of fresh, roof water was obtained from another roof in the same vicinity. Table 3 summarizes sources of water samples considered herein.

Storage tank water samples were obtained from ten systems, including three of those described in the previous sections, and analytical results from other roofs were contributed by the Nova Scotia Department of the Environment and Transport Canada. Water from eight of these systems is used for drinking, in six cases directly from the storage tank. Only two of the ten surveyed households who drink water without boiling have had their water tested. Two of those who do not use the water for drinking indicated that their water had been tested, with results that were "okay" or "better than well water". Water

TABLE 3. SOURCES OF WATER SAMPLES

Source	No. of Samples	Comments
Roof		
Technical University (05/14/77) .....	3	(Sequential)
(04/03/77) .....	1	
McLean Street (04/03/77) .....	1	
Roof Water Storage		
No. 1 .....	2	Treated after storage
No. 2 .....	1	Not used for drinking
No. 3 .....	1	Hypochlorite added occasionally to tank
No. 4* .....	3	Not used for drinking
No. 5 to No. 11† .....	6	Drinking water from tank
Well Serving Combined		
Roof/Well System .....	2	

\*Results made available by Nova Scotia Department of the Environment.

†Results made available by Transport Canada.

from the remaining systems was not tested.

Results of water analyses were summarized in Table 4. Roof water pH values are comparable with pH values, which varied from 4.5 to 5.0, in rainfall in Nova Scotia recorded by Underwood (1981). pH and alkalinity values in cistern and well samples are higher than in roof water, presumably because of ions contributed respectively by tank walls or well water. Higher concentrations of minerals in the well serving one of the combined roof water/ground-water systems reflects the mixing of water from the two sources. Samples from Department of Transport lighthouses contain higher chlorides, dissolved solids, and conductivities that reflect salt spray on roofs, despite wasting of roof water at the beginning of storms.

Consistently higher concentrations of all constituents in samples from roof leaders at the Technical University, compared with McLean Street samples, can be explained by differences in the two buildings. The structure at the Technical University is a very old building with a roof that includes considerable amounts of lead flashing which are apparently responsible for higher lead concentrations. An upper roof, which is sloped and covered with asphalt shingles, drains onto a lower flat tar-and-gravel roof, on which materials can accumulate until they are washed off in heavy storms. The flat roof is overhung with trees, increasing the probable accumulation of bird droppings and vegetation. The McLean Street roof is covered with new asphalt shingles, is fairly steeply sloped, and is believed to be washed even in small storms. Samples from both roofs were both collected on a day with 2.0 cm of rainfall. The three sequential samples from the roof at the Technical University were collected at 2.5-hr intervals, commencing at the beginning of the storm, on a day with 1.2 cm of rainfall. Cleaning of the roof by rain is indicated by lower concentrations of many constituents in the later samples.

Comparisons of the collected samples with Canadian drinking water standards indicate that, except for those collected from the roof at the Technical

TABLE 4. SUMMARY OF WATER ANALYSES

PARAMETER	ROOF Technical University			ROOF McLean St.			STORAGE	Well <sup>c</sup>	Canadian Drinking Water Stds. <sup>d</sup>
	14 Mar.		Apr.	Apr.	Nos. 1-4 <sup>a</sup>	Nos. 5-11 <sup>b</sup>			
	1	2	3	3	3				
	----- (mg/l)* -----								
Sodium	5.2	2.5	3.3	2.1	0.7	<0.1-5.2	-	1.4-57	-
Potassium	3.2	0.8	0.5	<0.2	<0.2 <sup>a</sup>	0.1-3.2	-	0.3	-
Calcium	9.6	3.0	5.2	2.0	<1.0	1.2-6.8	-	<1-2.1	-
Magnesium	1.7	<1	1.0	<1	<1	<0.1-<1.0	-	1	-
Hardness (CaCO <sub>3</sub> )	31	11	16	7.5	1.3	4.2-18	29-95	1.5-5.7	-
Alkalinity (CaCO <sub>3</sub> )	<1	<1	<1	<1	1.5	1.5-19	4.5-41	4.5-78	-
Sulfate	35	14	18	5.5	<1	1.4-8	3.5-30	3-8	150-500
Chloride	8.8	4.0	5.0	2.8	1.0	1.0-14	13-183	2.2-22	250-250
Fluoride	<0.1	<0.1	<0.1	<0.1	<0.1	<0.1-0.3	-	<0.1-0.1	1.0-1.5
Silica (reactive)	1.0	<1.0	<1.0	<1.0	<1	<1.0-2.8	-	0.9-7.4	-
Phosphate, Ortho	0.03	0.03	0.03	<0.02	<0.02	<0.02	<0.05-0.48	0.03-0.08	-
Total	0.05	0.05	0.02	----	----	0.02-0.04	-	0.11	-
Nitrite + Nitrate N	0.9	0.2	0.3	0.1	<0.1	<0.1-0.4	<0.05	0.2-0.3	0.001-10
Ammonia	0.5	<0.1	<0.1	0.1	<0.005	<0.1	<0.02-0.52	<0.1	-
Kjeldahl Nitrogen	1.9	0.8	0.3	---	----	0.1-0.34	-	0.2	-
Iron	1.0	0.3	0.3	0.2	0.1	0.1-0.6	<0.02-0.52	<0.1-0.2	0.05-0.3
Manganese	0.2	0.09	0.07	<0.07	<0.05	<0.05-0.06	<0.01-0.04	<0.05	0.01-0.05
Lead	0.8	0.5	0.3	0.33	0.005	0.007-0.08	<0.005-0.03	<0.005-0.02	0.001-0.05
Copper	0.05	0.1	0.07	0.10	0.05	0.06-0.88	<0.01-0.06	0.01-0.02	1.0-1.0
Zinc	3.0	1.1	1.4	0.39	<0.005	0.3-0.45	0.08-0.32	<0.005-0.02	5.0-5.0
Total Solids	183	53	44	28	16	11-50	41-397	16-148	-
Total Diss. Solids	81	35	39	14	10	6-49	-	13-147	-500
Color (TCU)	5	45	40	5	10	5-20	-	5-25	-
Turbidity (JTU)	10	2.5	3.0	2.6	1.4	0.8-6.5	-	2-2.4	1-5
Conductivity	140	70	66	40	13	13-75	108-650	29-300	-
pH	4.0	4.3	5.3	4.4	4.9	6.9-9.3	6.9-9.3	6.3-7.4	6.5-8.5
Arsenic	<0.005	<0.005	<0.005	<0.005	---	<0.005-0.009	-	<0.005	0.005-0.05
Total Org. Carbon	17	16	-----	-----	---	1.5-6.0	-	6.5-9.0	-
Total Coliform	0	20	2	0	0	0	0 <sup>e</sup>	0	<10 <sup>f</sup>
Fecal Coliform	0	0	0	0	0	0	0	0	0

\*Units in mg/l, except color (TCU), Turbidity (JTU), Total and Fecal Coliform (no./100 ml).

<sup>a</sup>Four samples collected from 3 households for this study; 3 samples collected from one household by Nova Scotia Dept. of Environment.

<sup>b</sup>Six samples from 6 households collected by Transport Canada.

<sup>c</sup>Two samples from well serving combined roof/well system.

<sup>d</sup>First value is upper limit of objective concentration; second value is maximum acceptable concentration (Health & Welfare Canada 1978).

<sup>e</sup>Bacteriological samples from only 2 Transport Canada dwellings.

<sup>f</sup>No sample to contain more than 10 coliforms/100 ml; not more than 10% of samples and not more than 2 sequential samples to contain coliforms (Health & Welfare Canada 1978).

University at the beginning of a storm, the chemical quality of roof water is excellent. Of all samples, only those from the roof of the Technical University contained coliforms, and even in these fecal coliforms were absent. No data are available to determine whether spring and summer concentrations would significantly differ from those reported here, which represent samples collected during the October to March period.

The Nova Scotia Department of Health has recognized roof water as a domestic source in guidelines that will be available for distribution late in 1981 (Division of Public Health Engineering 1981). The guidelines recommend that roof water be used for drinking only if no other source is available, and then only if disinfected. They describe details of storage tanks, and suggest a storage capacity of 9092 l/capita, corresponding to three to four months of storage for an average household. Wasting of initial rainfall, by a valve or by an automatic device, is recommended.

#### YIELD OF ROOF WATER SYSTEMS

The annual average precipitation in Nova Scotia varies from 100 to 160 cm/yr: rainfall represents 80 to 120 cm, the remainder being snowfall (Gates 1975). Total annual precipitation and rainfall at Halifax average respectively 138 and 118 cm.

If 100% of the precipitation on a roof surface is recovered, 138 cm/yr would provide 1,380 l/m<sup>2</sup>/yr, and if the area of a typical roof described previously is 112 m<sup>2</sup>, the annual yield would be 155,000 l. If allowances made for losses from unguttered portions of roofs and from full gutters in heavy rains, wastage from full tanks, and evaporation from melting snow, an optimistic estimate of recovery from total precipitation might be 70%. Applying these values of a household that includes four persons yields a supply of 74 l/capita/day.

The Nova Scotia guidelines (Division of Public Health Engineering 1981) indicate that per capita water demands across the province vary from 45 to 273 l/capita/day, and suggest that 91 l/capita/day is a reasonable estimate for households that depend on and carefully use roof water. It may be noted, however, that a single-family residential area in Halifax consumes approximately 160 l/capita/day, and if occupants of houses using roof water have expectations and habits based on availability of water from municipal systems, they may be disappointed by the amount of water available from a roof water system.

Table 5 represents an attempt to estimate storage required for a roof water system at Halifax. The table assumes that, during a severe dry period, water conservation practices might reduce demand to 90% of the long-term average supply. The maximum storage requirement from Table 5 is 62.3 cm or 623 l/m<sup>2</sup> of effective roof area. Assuming 70% recovery from total precipitation, this corresponds to 436 l/m<sup>2</sup> of total roof area, or 48,800 l of storage for a 112-m<sup>2</sup> roof.

Considering the foregoing discussion, it is not surprising that those who rely on roof water in Nova Scotia find that shortages occur. Water demands on a typical household can be expected to exceed the average available supply,

TABLE 5. ESTIMATED MAXIMUM STORAGE REQUIREMENT  
OF NOVA SCOTIA ROOF WATER SYSTEM

Dry Period	Precipitation	Demand	Deficit
		----- -(cm)	
1 yr (Jan. 1965-Dec. 1965)	92.0	124.2	32.2
2 yr (Jan. 1965-Dec. 1966)	186.1	248.4	62.3
3 yr (May 1964-Apr. 1967)	317.6	372.6	55.0
4 yr (May 1963-Apr. 1967)	462.6	496.8	34.2

\*Demand in dry period estimated to be 90% of long-term precipitation of 138 cm/yr.

and storage in the systems examined in Nova Scotia is inadequate to sustain even this demand in a severe dry period.

Because it can provide a high quality supply, rain water from roofs offers an attractive alternative in areas of Nova Scotia where groundwater quality is inadequate. It cannot, however, in most circumstances, provide water in sufficient quantity that it can be depended on as the only source, unless strict conservation or recycling is practiced in the home.

#### ACKNOWLEDGMENTS

Chemical and bacteriological analyses for this project were provided by the Environmental Chemistry Laboratory, Nova Scotia Department of Health. Officials of Transport Canada provided much useful information.

#### REFERENCES

- Bower, D. 1981. Findings released from study of well water. The Mail Star, Halifax, 10 July 1981.
- Division of Public Health Engineering. 1979. Annual report. Nova Scotia Department of Health.
- Division of Public Health Engineering. 1981. "Use of rain water for domestic purposes in Nova Scotia." Nova Scotia Department of Health. (unpublished manuscript)
- Gates, A.D. 1975. The tourism and outdoor recreation climate of the maritime provinces. Appl. Meteorol., REC-3-73, Atmospheric Environment Service, Environment Canada.
- Health and Welfare Canada. 1978. Guidelines for Canadian drinking water quality.
- Underwood, J.K. 1981. Acidic precipitation in Nova Scotia. Nova Scotia Department of the Environment.

## COST ANALYSIS OF RAIN WATER CISTERN SYSTEMS

Yu-Si Fok, Professor  
 Department of Civil Engineering  
 and Researcher  
 Water Resources Research Center  
 University of Hawaii at Manoa  
 Honolulu, Hawaii 96822, USA

PingSun Leung  
 Assistant Professor  
 Department of Agricultural  
 and Resource Economics  
 University of Hawaii at Manoa  
 Honolulu, Hawaii 96822, USA

## INTRODUCTION

The economic feasibility of rain water cistern (RWC) systems is an important factor in its acceptance in the scheme of water resources planning and development. A cost analysis of this water supply system is complex because socioeconomic conditions vary in different countries. To present an unbiased cost analysis of a RWC system, a case-by-case format is preferable and, if possible, a cost comparison with the existing public water supply system should be also included. In general, RWC systems are financed with private funds, and public water supply systems with public funds. However, their costs to users may not differ too much. In addition, the cost of labor is another factor that should be considered in the cost analysis. It is this amount of labor that owners contribute to their own RWC systems that is difficult to document as a cost item. Thus, these factors should be considered by the readers of this paper.

## COST ANALYSIS

PRIVATE CISTERNS IN HONOLULU. According to the price list obtained from a water-tank supplier in Spring 1981, the cost for a redwood water tank of 3.66 m diameter and 3.66 m height with a conical cover is \$4,883 (US), F.O.B. from the Matson Dock in Oakland, California, in addition to a 4% sales tax. The cost of a corrugated metal tank of 3.66 m diameter and 3.05 m height, with a heavy duty vinyl liner but excluding a top cover is \$1,980 (F.O.B. anywhere on O'ahu). A cost list for other tank sizes are presented in Tables 1 and 2. For two comparable tanks of different construction materials, the estimated cost for the tank would be \$2,500—including pump and other accessory costs—if the cistern owner chose the metal tank and cover and installed the tank by himself. If the annual operation cost is \$50, the net interest rate is 5% (real interest rate = nominal interest rate - expected inflation rate\*) and the service life is 40 years. Thus, the present cost value of this cistern system can be computed as

$$\begin{aligned} \text{Present Cost Value} &= \text{Initial Cost} + \text{Annual Cost} \frac{(1 \div 0.05)^{40} - 1}{0.05(1 + 0.05)^{40}} \\ &= \$2,500 + 50(17.6) = \$3,358 \end{aligned}$$

\*Nominal interest rate used here is the current Moody corporate bond rate of 15% and the expected inflation rate used is the current change in GNP deflation of 10%.

TABLE 1. COST OF CORRUGATED METAL WATER TANKS AND TANK LINERS

CORRUGATED METAL WATER TANK				WATER TANK LINER		
Diam. x Ht. (ft)	Approx. Capacity (gal)	Price (\$)	Cost /gal (\$)	Steel Tank (\$)	Redwood Tank	
					Diam. x Ht. (ft)	Price (\$)
8 x 4	1,500	644.00	0.43	174.57	6 x 6	154.35
8 x 6	2,250	894.00	0.40	220.50	7 x 6	186.51
8 x 8	3,000	1132.00	0.38	266.45	8 x 6	220.50
12 x 6	5,000	1272.00	0.25	299.88	8'4" x 8	284.20
12 x 8	6,750	1626.00	0.24	355.74	10 x 6	250.88
12 x 10	8,500	1980.00	0.23	410.87	10 x 8	300.09
16 x 8	12,000	2127.00	0.18	521.12	11'6" x 6	302.65
16 x 10	15,000	2688.00	0.18	634.25	11 x 8	339.50
16 x 12	18,000	3160.00	0.18	713.44	13 x 6	356.75
16 x 14	21,000	3632.00	0.17	791.84	12 x 8	355.74
16 x 16	24,000	4100.00	0.17	871.00	10'6" x 10	371.60
20 x 8	18,800	2820.00	0.15	757.34	11'6" x 10	415.50
20 x 10	23,500	3407.00	0.14	855.34	12 x 10	410.87
20 x 12	28,200	3995.00	0.14	954.00	13 x 10	485.30
20 x 14	33,000	4583.00	0.14	1052.00	13'8" x 10	533.12
20 x 16	37,600	5172.00	0.14	1150.90	12'4" x 12	522.95
20 x 18	42,300	5760.00	0.14	1249.70	15'6" x 8	532.35
					13'8" x 12	602.10
					15 x 10	582.50
					14 x 14	671.10

SOURCE: SHELTERTECH, 570 Auahi Street, Honolulu, Hawaii 96813.

NOTE (Metal Tanks): Prices include punched and curved, corrugated galvanized sheets, each 2 ft in height, two through fittings, and all required bolts, nuts, and vinyl liner. Tank cover not included. All sheets minimum 16 gauge copper bearing steel, extra heavily galvanized. Liner is 0.025 FDA food grade, heavy-duty vinyl.

Prices for larger tanks, or tanks of different dimensions, available upon request.

DELIVERY. Prices F.O.B. any accessible destination on Oahu; neighbor island shipments, F.O.B. dock, Honolulu, freight prepaid to dock, neighbor island.

Prices subject to change without notice. All prices subject to the appropriate sales tax. Prices effective 1 February 1980.

ALSO AVAILABLE: Pumping and pressure systems, filters, engineering.

NOTE (Tank Liner): Quotations available on request for special sizes. Fittings only; Hayward 1½ in. PVC flange fitting for liner = \$6.00 (U.S.).

TABLE 2. SIZE, WEIGHT, AND COST OF REDWOOD TANKS AND COVERS

TANKS, JOISTS, GALVANIZED HOOPS					COVER COST	
Capacity* (gal)	Diam. x Ht. (ft-in.)		Wt.† (lb)	Price (\$)	Flat (\$)	Conical (\$)
1,500	7'	6	855	1232.00	206.80	357.50
2,000	8'	6	1000	1449.80	242.00	425.70
3,000	8'4"	8	1320	1875.50	250.80	429.00
3,000	10'	6	1320	1900.80	366.30	568.70
4,000	10	8	1615	2372.70	366.30	568.70
4,000	11'6"	6	1615	2420.00	487.30	728.20
5,000	11'	8	1800	2664.20	410.30	643.50
5,000	13'	6	1800	2722.50	557.70	808.50
6,000	12'	8	2000	3010.70	444.40	728.20
6,000	10'6"	10	2000	2967.80	366.30	568.70
7,000	11'6"	10	2265	3290.10	487.30	728.20
8,000	12'	10	2390	3468.30	548.90	728.20
9,000	13'	10	2630	3821.40	557.70	808.50
10,000	13'8"	10	2800	4137.10	585.20	856.90
10,000	12'4"	12	2800	4079.90	557.70	754.60
10,000	15'6"	8	2800	4195.40	639.10	943.80
12,000	13'8"	12	3300	4602.40	585.20	856.90
12,000	15'	10	3300	4653.00	610.50	1007.60
15,000	14'	14	4200	5740.90	590.70	930.60

SOURCE: SHELTERTECH, Honolulu, Hawaii.

NOTE: All tanks manufactured from clear, all-heart redwood 2-in. material; ≤1000-gal redwood tanks to be locally manufactured. Exact stave length 1 in. shorter than nominal length in ft; 4-x-6 chime joists used on all tanks.

Water level registers \$10.00/ft of stave height extra; ladders \$10.00/ft of stave height extra. Dimensions other than those shown and larger tank prices on request including installed prices; sizes subject to availability of materials.

Prices for covers, registers, and ladders apply only when ordered with tank. Prices subject to 4% sales tax and subject to change without notice. Prices F.O.B. Matson Dock, Oakland, California (effective 1 March 1981).

\*Approximate.

†Estimated.



PUBLIC WATER SUPPLY IN HONOLULU. According to the 1980 City and County of Honolulu Board of Water Supply report, the average family in Honolulu pays about \$164 per year for their water supply. Cost items include:

Monthly service fee	\$2.28 x 12 = \$ 27.40
Monthly water quantity fee (@ \$.76/1000 gal)	\$0.76 x 180 = <u>136.80</u>
Total annual cost	= \$164.20

In addition, the one-time water development charge to a new house is \$600 with the following itemized breakdown.

Source development	\$330
Pipeline	140
<u>Storage</u>	<u>130</u>
Total initial cost	\$600

Based on the costs listed above, the present value of the cost of using public water supply systems can be calculated as follows:

$$\begin{aligned} \text{Present Cost Value} &= \text{Initial Cost} + \text{Annual Cost (series present-worth factor)} \\ &= \$600 + \$164.20 (\$17.16) = \$3,418. \end{aligned}$$

PRIVATE CISTERN SYSTEMS VS. PUBLIC WATER SUPPLY SYSTEMS. From the above computations of the present cost values of the two systems, there is only a slight difference in the respective costs of \$3,358 vs. \$3,418 for the private vs. public systems. In fact, the costs of both systems are identical at an interest rate of 5.21%. Below this rate of 5.21%, the cistern system will be more favorable economically and vice versa for rates above 5.21%. However, choosing the appropriate interest rate for discounting depends largely on specific situations. The following shows the present values of the costs of the two systems for a range of interest rates from 3 to 7% (which would probably encompass the most likely range of real interest rates):

Interest Rate (%)	Series Present-Worth Factor	PRESENT COST VALUES	
		Cistern System	Public System
3.0	23.11	3656	4395
4.0	19.79	3490	3850
5.0	17.16	3358	3418
5.21	16.64	3332	3332
6.0	15.05	3252	3071
7.0	13.33	3249	3059

The present cost values of both systems are not very different for this range of interest rates, particularly at the high cost level.

The above analysis assumes that all the costs will increase or decrease at the same rates, i.e., all the costs are assumed to remain at their 1980 constant dollar values, which may not be totally true in this case.

An examination of Honolulu's past 10-yr public water rate schedule indicated that it has not kept pace with the consumer price index (5.6% vs. 7.2%). This is an indication that public water supply systems have the advantage of financing their systems. The Honolulu Board of Water Supply is financially independent and has to balance its budget. Forecasting the difference

of changes in costs for both systems for a 40-yr period is admittedly an extremely difficult task.

In addition, it should be clearly stated that the above analysis is purely in terms of economic feasibility. The private rain water cistern system is not 100% reliable because it depends on rainfall; therefore, certain risk factors should be included in the cost analysis. On the other hand, externalities of the cistern system, such as the potential of storm runoff reductions is not included. These and other factors have to be considered in order to assess the real benefit of the cistern system.

PRIVATE CISTERNS IN COLUMBUS, OHIO. According to the price list furnished by a retail company, the price of storage tanks with lids (top covers) range from \$1300 to \$2955 (F.O.B., Columbus, Ohio). Because this retailer did not indicate the construction material, the various sizes and volumes of these storage tanks, no cost analysis can be made. However, price lists from this company are presented in Tables 3 and 4.

PRIVATE CISTERN SYSTEMS IN CALIFORNIA. According to Milne (1979), a rain water cistern was designed for a house in Southern California based on the following data:

Effective annual rainfall .....	381 mm (15 in.)
Roof top catchment area .....	185.8 m <sup>2</sup> (2000 ft <sup>2</sup> )
Evaporation loss .....	20%
Total annual water supply .....	56,781 ℓ (15,000 gal)
Fire protection reserve .....	11,356 ℓ ( 3,000 gal)
Average daily water supply (1st yr) .....	125 ℓ ( 33 gal)
Average daily water supply (2d yr onward) ...	156 ℓ ( 41 gal)
Volume of cistern .....	56,781 ℓ (15,000 gal)

	<u>Cost</u>
Sand filter bed	\$1,000
Plastic membrane-lined cistern	\$4,000
Solar still	\$ 400
Bottled water pumping system	\$ 200

This house was located on the top of a hill. If water is supplied by a 600-foot deep well (183 me), the cost of the well and accessories would be over \$20,000. Apparently that site and neighborhood is not serviced by a public water supply system; therefore, the only alternative water supply source was a 600-foot deep well. In this publication, Milne (1979) reported the cost of storage tanks as

Plastic garbage can with 208-ℓ (55-gal) capacity	\$10-\$35
208-ℓ (55-gal) drum (used)	\$5
Polyethylene tank, 568 ℓ (150 gal)	\$200
Fiberglass tanks: 2271 ℓ (600 gal)	\$600
6814 ℓ (1800 gal)	\$1,000
Covered, corrugated steel-wall portable swimming pool:	
3785 ℓ (1000 gal)	\$50
18,925 ℓ (5000 gal)	\$200.

Portable swimming pools used as water tanks are reported as probably the easiest to clean, relocate, and repair.

TABLE 3. POND WATER PLANTS: FILTRATION AND DISINFECTION EQUIPMENT

SAFE DRINKING WATER FROM PONDS

Dual Positive Displacement chlorine feeder that cannot clog up 7 hr chlorine contact time, plus thorough mixing by passing through million grams of sand, plus 30 min rechlorination after charcoal filter to assure safe residual.

FILTERS ALONE WILL NOT PROVIDE SAFE DRINKING WATER

Filters remove algae and large suspended particulate matter to prevent clogging of valves in stock tanks, chicken waterers or drinking cups.

Production /day (gal)	Sand Filters	Storage Tanks with Lids	F.O.B. Columbus, Ohio
400	1	1	\$ 1300.00
400	1	2	1500.00
400	1	3	1700.00
800	2	2	2030.00
800	2	3	2230.00
1200	3	3	2755.00
1200	3	4	2955.00

For use with a buried cistern (clearwell) to provide a large reserve of treated water for the house and for fire protection

400	1	0	1100.00
800	2	0	1625.00
1200	3	0	2150.00

EXTRA COMPONENTS

Lid	35.00
BLANKETS	
Set of 3: 32-in. Round	12.00
Set of 3: 34-in. Round	12.50
Set of 3: 32 in. x 54 in.	15.00
Single: 54 in. x 126 in.	17.00
Freight on sand and gravel varies with distance	
400 gpd Water Plant	55.00
800 gpd Water Plant	110.00
Add crating charge for shipments by truck	100.00
Our charge to deliver and supervise installation	
Above prices include sand, gravel and charcoal, and DO NOT include pipe, laying pipe, ditching, back filling or freight on sand and gravel.	
Freight on sand and gravel for a 400 gpd Water Plant	55.00
Freight on sand and gravel for an 800 gpd Water Plant	110.00
Delivery on any water plant anywhere in Ohio	55.00
Trip to survey job	

TERMS—CASH ON DELIVERY OF ANY COMPONENTS. F.O.B. COLUMBUS, OHIO. Components cannot be furnished on job, then wait 30 days-14 months until subcontractors finish plumbing, wiring or heating. Ohio State Sales Tax is 4%.

SOURCE: Surface Water Treatment Co., 791 S. Lazelle St., Columbus, Ohio 43206.

TABLE 4. FILTER AND REPLACEMENT FILTER ELEMENTS

Floating Farm Pond or Lake Filter	\$ 109.00
Floating Farm Cistern Filter	85.00
Submerged Lake Filter with anchor rope guide	103.00
Dug Well Filter	85.00
Streams or Shallow Well Collector Filter	85.00
Spring Development Filter	60.00
Water Heat Pump Filters (Pop-Up)	
10,000 gpd needs 3 Filters and 3 anchor rope guides (tie ropes only)	390.00
17,000 gpd needs 4 Filters and 4 anchor rope guides (tie ropes only)	508.00
Replacement Filter Elements for all above	28.00
Floating Pump Cage with anchor rope guide and 15-ft suction hose to connect	285.00
Floating Farm Pond or Lake Filter Pump Cage with anchor rope guide to be used with submerged (Pop-Up) Lake Filter or Heat Pump Filter in a lake	300.00
Flexible pipe to connect cage to house line in bottom of pond—length as needed	Extra

## OPTIONAL EQUIPMENT

1½ in. ALL BRASS LINE CHECK VALVE	20.25
Anchor rope guide with tie ropes only	18.00
1½ in. FLEXIBLE SUCTION HOSE with fittings in place and double clamped	
10-ft lengths	33.25
15-ft lengths	43.50
20-ft lengths	50.75
30-ft lengths	73.75
40-ft lengths	94.10
50-ft lengths	114.40
Longer lengths available (price/ft)	2.30
½ in. Polyethelene Rope for anchor or pull to shore lines (SPECIFY WHICH)	
30-ft length, with clamps or loops	6.65
40-ft length, with clamps or loops	8.85
50-ft length, with clamps or loops	11.05
60-ft length, with clamps or loops	13.30
70-ft length, with clamps or loops	15.50
Longer lengths available (price/ft)	0.15

SOURCE: Surface Water Treatment Co., 791 S. Lazelle St., Columbus, OH 43206.

NOTE: Filter or Replacement Filter Elements shipped Parcel Post, U.P.S. or truck upon receipt of Check or Money Order.

## DISCUSSION

OVERVIEW OF CISTERN COSTS. As presented earlier in this paper, cost analyses of rain water cistern systems are complex because economic backgrounds vary between countries. Thus, this paper also includes a cost analysis based on the economic feasibility viewpoint for adapting rain water cisterns as an alternative to public water supply systems reported from Indonesia. Several papers have been presented on the West Java Rural Water Supply Project. Figure 1 includes the cost of various cisterns made of different materials; the exchange rate of one U.S. dollar to 629 Indonesian rupiahs; the cost functions of redwood tanks, corrugated-steel tanks, and portable, plastic swimming pools.

It can be seen in Figure 1 that the cost function of a redwood tank is the highest, the corrugated-steel tank slightly less than concrete tanks, and the portable, plastic swimming pool is within the low-cost category. In other words, the flexible, impervious membrane, which is popular in other construction field applications, can also be successfully used for rain water cistern systems (Fok and Murabayashi 1980).

FLEXIBLE MEMBRANES FOR CISTERN CONSTRUCTION. Flexible, impervious membranes have been used to line reservoirs or farm ponds in many parts of the world. Currently, according to Fok and Murabayashi (1981), prefabricated membrane tanks (bags) can be packed into a 500-kg (5-ton) unit for shipment and can be joined together with other sections in the field to cover any size of area from 4 050 m<sup>2</sup> (1 acre) to 405 000 m<sup>2</sup> (100 acre). Thus, using modern technology, a membrane water tank can be prefabricated to store up to 3 785 m<sup>3</sup> (1 mil gal). In the near or immediate future, prefabricated membrane tanks will probably be used as rain water cisterns to store rain water in many parts of the world to beat the goal set up by the United Nations for the Safe Drinking Water Supply and Sanitation Decade. The prefabricated membrane water tank is economical, easy to manufacture, light in weight, easy to pack and ship, durable, and low in maintenance cost if installed properly, and is already available. What remains to be done includes: its design; testing its applicability; and writing a manual for users on emplacement, protection from damage, and maintenance. Because these membrane tanks must be supported, users would have to devise a supporting framework with local materials. This would then be a self-help project, using local resources and labor. In return, the estimated total cost for providing safe drinking water to everyone on earth at more than \$200 billion (U.S.) would be tremendously reduced.

## CONCLUSIONS

Cost analyses of rain water cistern systems have been presented. In Honolulu, Hawaii, we have found that the public water supply and the cistern systems are economically almost comparable. However, because the cistern system is not 100% reliable, the choice between the two systems will depend on the rainfall patterns of the area and the individual's risk preference. Also, the externalities of using cistern systems may be large enough to establish some sort of tax incentives for cistern owners. This action might make the cistern system even more favorable. However, the rain water cistern system might have to be more seriously considered if the public water supply system increased its initial or unit water costs, or if the limited groundwater supply could not meet increasing demand because of population growth. The cost

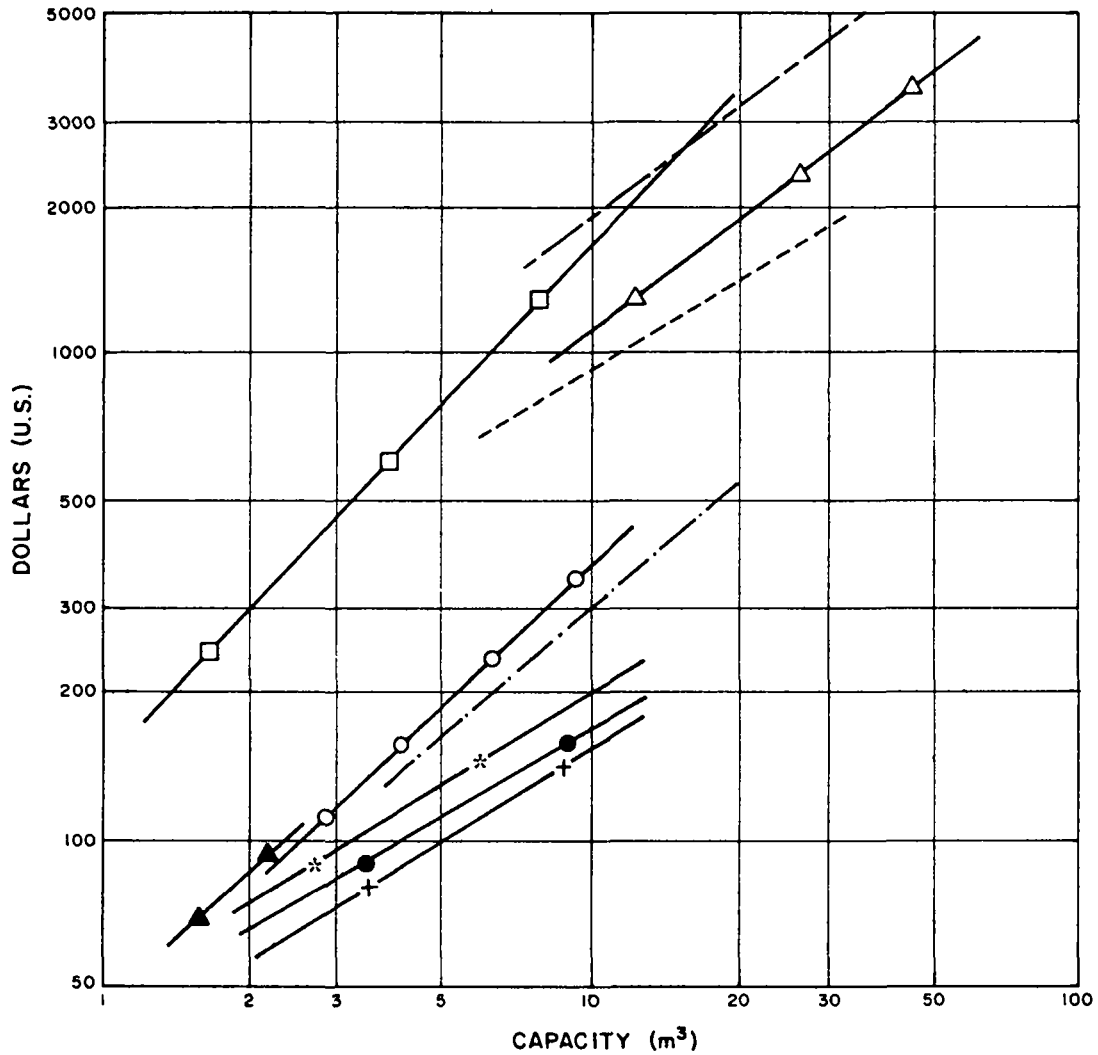

LEGEND	
□ Fiberglass	○ Brick work
△ Reinforced concrete	▲ Clay ring
* Ferrocement	--- Redwood
+ Bamboo cement	--- Sheet metal
● Ijuk cement	--- Sears portable swimming pool

SOURCE: After Java Water Supply Project (Ir. A. Tuinhof) Rep. No. 515-3, Fig. 11.

NOTE: Prices of rain water collectors (November 1979 price level).

Excludes: taxes, profits; costs of form work (ferro, ijuk, and bamboo cement); and transport of materials.

Figure 1. Cost of rain water collectors

analysis for a rain water cistern system in California suggested that the system is a favorable choice for areas without a public water supply system, and that the other alternative would be the development of a 600-foot (183-m) deep well whose initial cost would be considerably higher.

Cost comparisons for rain water cistern systems in Indonesia and the United States provided the relative cost levels for construction materials. Redwood and corrugated-steel tanks have the highest initial costs, while flexible membrane tanks (portable, plastic, prefabricated swimming pools) is among the lowest in cost. On the basis of construction material and method, installation, maintenance, durability, and utilization of local material and labor, membrane water tanks would be the choice for mass production and worldwide distribution to meet the goal set by the United Nations for the Safe Drinking Water Supply and Sanitation Decade.

#### REFERENCES

- Board of Water Supply. 1979. Annual report and statistical summary: July 1, 1978-June 30, 1979. City and County of Honolulu, Hawaii. 116 p.
- Fok, Y.S., and Murabayashi, E.T. 1981. Utilization of flexible membrane to impound runoff water in receiving coast for water conservation and quality control. In Proc., Int. Conf. on Water Resources Development, in Taipei, Taiwan, Republic of China.
- Fok, Y.S., and Murabayashi, E.T. 1981. Water reuse by rain water cisterns and impervious membranes. In Proc. Water Reuse Symp. II, Am. Water Works Assoc., Denver, Colorado. (In press)
- Milne, M. 1979. Residential water re-use. Rep. No. 46, California Water Resources Center, University of California-Davis, Davis, California.
- Tuinhof, A. 1979. West Java rural water supply project OTA-33/J-7. Jalan Sederhanh 7 Tromol Pos 59, Bandung, Indonesia.

## SOME ASPECTS OF ROOF WATER COLLECTION IN A SUBTROPICAL REGION

Adhityan Appan, Associate Professor  
School of Civil and Structural Engineering  
Nanyang Technological Institute  
REPUBLIC OF SINGAPORE

### INTRODUCTION

The ever-increasing demand for water is making man look towards different means of conservation and new methods of abstracting water. The concept of collecting and storing rain water, an age-old practice, could prove to be an encouraging additional source that could very well enhance the limited and apparently dwindling supply of water.

In a city-state like Singapore, there are competing demands for use of limited land area and, with the added rapid economic growth and industrial development, there is an even greater demand for water. Singapore lies 8° north of the equator, has an average ambient temperature of 26°C and a population of 2.3 million. With the twin assets of 70% of the population living in high-rise flats and an average annual rainfall of 2 230 mm, it would appear to augur well for the harnessing of roof water as a supplementary source of water.

### OBJECTIVES IN ROOF WATER COLLECTION

The main objectives in such systems are the establishment of a relationship between variables (e.g., cistern volumes and roof areas) using data such as rainfall and evaporation and to relate them to the amount of rain water that can be fruitfully utilized. Due to the stochastic nature of rainfall, probability of occurrence has been used by Dhruva Narayana (1979) and Fok et al. (1980) to carry out studies.

In this exercise which is only a preliminary study, actual rainfall data covering a period of only 10 years is being used to establish whether a large-scale working system is possible rather than to finalize the relevant design parameters. The main objectives include:

1. To establish a relationship between cistern volumes, roof areas and the corresponding volume of rain water that can be utilized
2. To determine the frequency with which the cistern is empty, the frequency with which spillages occur and the percentage of total rain water that is used
3. To establish the quality of roof water and to determine environmental problems such as mosquito breeding.



## PROPOSED ROOF-WATER COLLECTION

Rain water falling on the roof area may be channelled to a collection cistern that is connected to a potable water storage tank by a pipe line. Two valves could be adjusted at appropriate levels in the roof water cistern. When the roof water supply is depleted, the valve controlling the input from the potable water storage tank starts operating and permits the supply of potable water to meet the demand. Thus, the demands required of the roof water cistern are continuously met by either the potable or roof water.

## PRINCIPLE OF FLOW CHART

It is assumed that, in a known location, the daily values of rainfall, evaporation and roof absorption are available for a considerable period of time. Using this data, the quantity of water in the cistern at the end of day  $i$  will be

$$Q_i = Ar_i - [(E_i + b_i) + D]$$

where

$Q_i$  = quantity of water at end of day  $i$

$A$  = roof area

$r_i$  = rainfall during day  $i$

$E_i$  = evaporation rate in day  $i$

$b_i$  = roof absorption rate in day  $i$

$D$  = daily draft.

In equation (1), the roof water cistern will be respectively empty or include spillage in day  $i$  according as  $Ar_i \lesseqgtr (K_i + a_i) + D$ .

Using this simple concept, a flow chart representing the different operations is presented in Figure 1. Included in the system are parameters that determine, on an annual basis, the volume of total rain water used, volume of spillage, number of days of spillage and number of days the roof water cistern is empty. It is assumed that at the beginning of the exercise the cistern is empty.

## CASE STUDY RESULTS

COMPUTER RUNS. Using the flow chart, a computer program was developed. The roof areas, cistern volumes and draft rates were treated as variables to obtain the amount of roof water that can be actually utilized. Using daily rainfall, evaporation and roof absorption data for a continuous 10-year period, printouts have been utilized to generate a series of curves (Fig. 2).

It can be ascertained from these curves that at lower ranges of cistern capacities (from, say, 12-35 m<sup>3</sup>) the variability in the volumes of roof water utilized hardly varies from 22 to 35%. There is, however, a marked increase in the utilizable roof water as the cistern capacities are increased beyond the above-mentioned range. Besides, as the maximum roof areas are approached the quantity of usable roof water tends to increase even more considerably.

LEGEND

- N = Number of days of rainfall data
- R(N) = Rainfall for day N
- A = Roof area
- D = Daily draft
- E(N) = Evaporation for day N
- B(N) = Absorption for day N
- V = Volume of storage
- Q1(N) = Gross volume at beginning of day
- Q2(N) = Gross volume of water remaining
- S2(N) = Overflow volume of water at end of day
- Z = Cumulative overflow volume

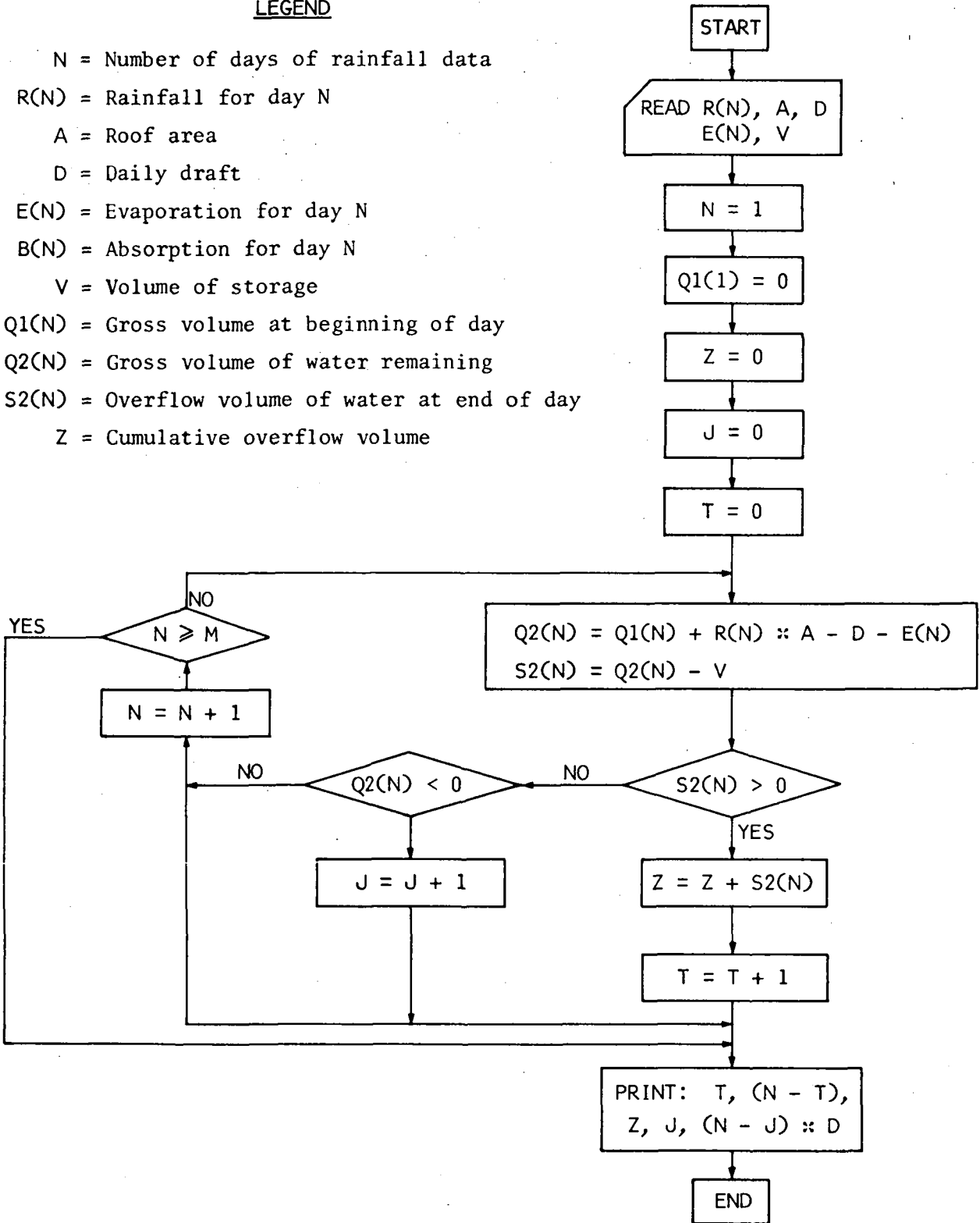

Figure 1. Flow chart for roof water collection system

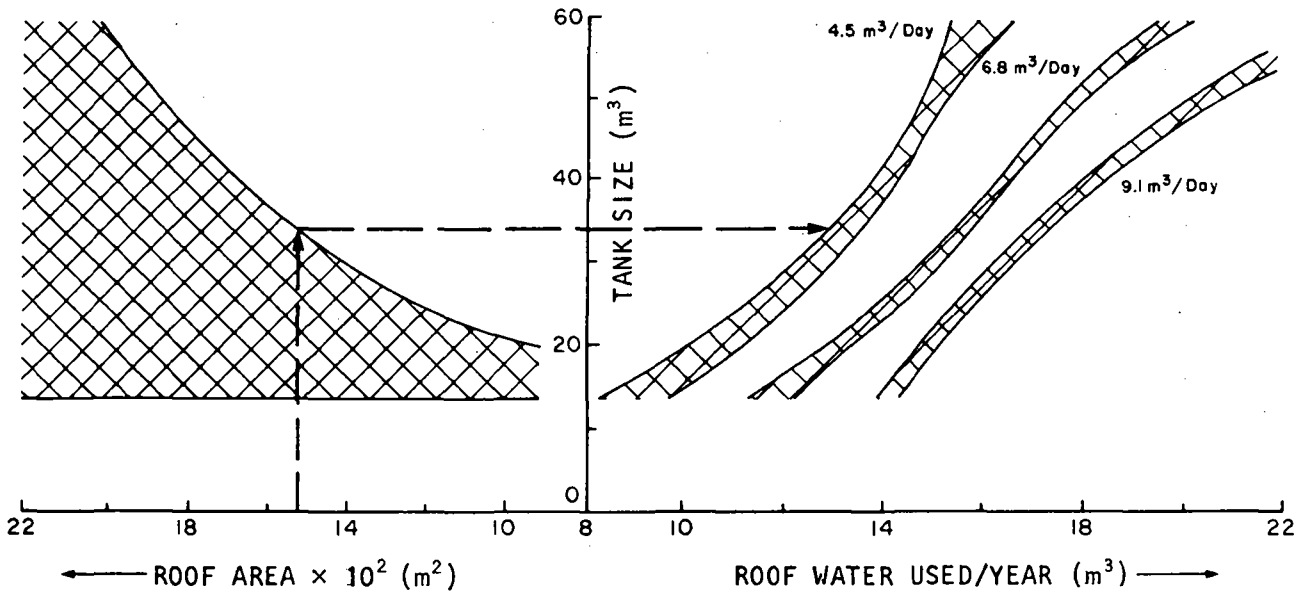

Figure 2. Relationship between roof area, tank size, draft and annual roof water usage

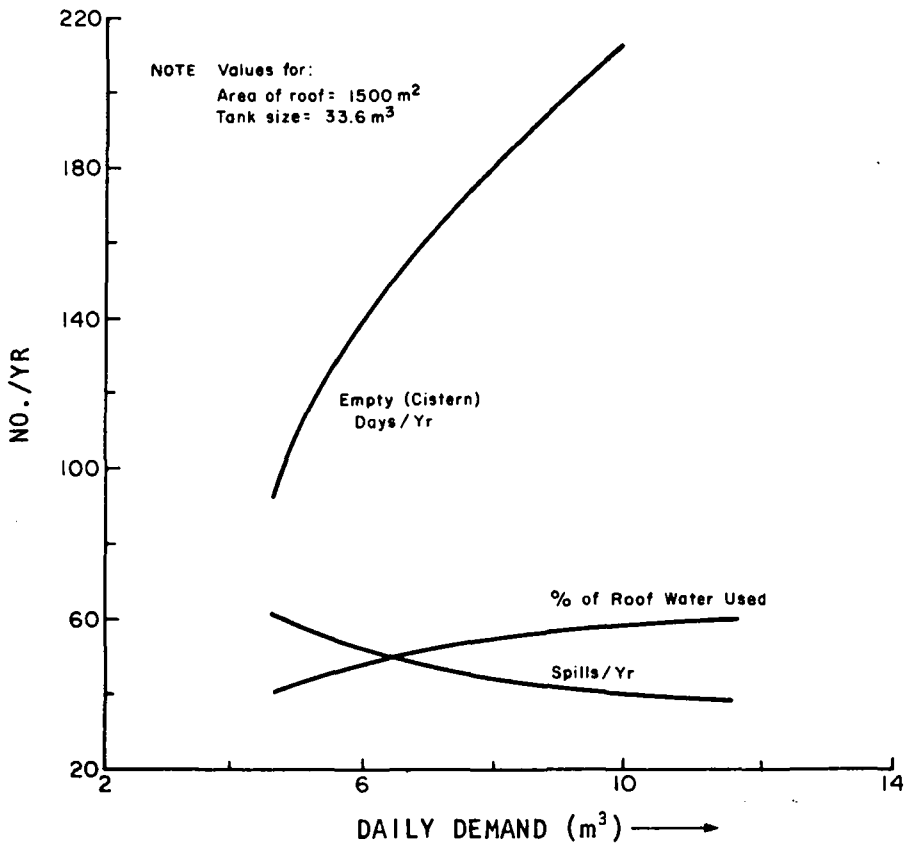

Figure 3. Typical values for spills, empty (cistern) days and percentage roof water used

In Figure 3 is plotted, in relation to the draft, the annual values of number of times the cistern is empty and the percentage of usable rain water. From the printouts, the trends are found to be identical for the different sets of cistern volumes and roof areas. From the figure, it is clear that as the daily demands increase, the annual number of empty (cistern) days tend to increase but that the number of spills per year and the percentage of total rain water utilized tend to increase.

**ROOF WATER QUALITY.** Water samples were collected over a period of time and physical, chemical and bacteriological analyses were conducted. The results are shown in Table 1. Also shown in this table are the quality of treated water being supplied in Singapore as shown in the Handbook on Application for Water Supply (Public Utilities Board 1979) and also in the *International Standards* (WHO 1971). As the values obtained for the water samples were fairly uniform, mean values are shown. The appearance of the rain water was quite acceptable but parameters such as, conductivity, total solids, total alkalinity and total hardness appear to have values on the high side. Though the coliform count fall well within the limits, the standard plate counts indicate higher values than that of the local treated water.

TABLE 1. QUALITY OF ROOF WATER, TREATED WATER AND INTERNATIONAL STANDARDS

Parameter	Treated Water	International Standards (Highest desirable level)	Roof Water (Mean Values)
Color <sup>‡</sup>	<5	5	7
Turbidity (silica units)	<5	5	2
pH	7.5	7.0-8.5	7.3
Temperature (°C)	29	+	28
Conductivity (µmhos/cm)	70	+	83
Total Alkalinity, as CaCO <sub>3</sub> (mg/l)	12	+	27
Total Hardness, as CaCO <sub>3</sub> (mg/l)	30	100	33
Total Solids (mg/l)	50	500	59
Chloride (mg/l)	14	200	6
Standard Plate Counts per ml in 24 hr @ 37°C	<10	+	19
Coliform Organisms/100 ml in 24 hr @ 37°C	0	0	0

NOTE: + = values not specified.

\*Water entering the distribution system.

†See References.

‡A. Hazen (1892, 1896).

ENVIRONMENTAL FACTORS. There is no evidence of mosquito larvae or eggs in rain water but the opportunity exists especially when the rain water is stored in open cisterns and when the water is stagnant. It has been observed that the breeding of mosquitos is more prevalent in low structures than in high-rise buildings. In the case of low structures, a simple device incorporated in the inlet pipe that brings in the roof water can be very effective. This device can take the form of a fine wire mesh that will effectively filter all the input thus ensuring that neither mosquito eggs nor larvae can enter the storage cistern.

## DISCUSSION AND CONCLUSIONS

1. From the established relationships between the roof water cistern volumes, roof areas, draft and the amount of abstractable roof water, it is obvious that the volume of the cistern is crucial if large volumes of rain water are to be utilized. Besides, the roof area is constant in each different location and, at the most, it can be manipulated to a lower value. Further detailed studies need be undertaken to ascertain the roof area-cistern volume relationship to arrive at an optimal abstraction system.

2. The large capital costs for such roof water collection systems can be discouraging especially as treated water of a high order is at present a relatively cheap and a readily available commodity in the local context. However, this issue has to be viewed on a country-wide basis.

In fact, currently, the potential exists for using roof water for non-potable purposes in the domestic sector to the extent of 40 000 to 50 000 m<sup>3</sup>/day. Such a substantial volume, if negated from the present domestic (treated) water demand will lead to a corresponding reduction in the total supply. Consequently, there will be a considerable economic gain in the form of deferred capital for proposed demand-related schemes (Standing Technical Committee Reports 1980). This considerable economic benefit should also be taken into account when the capital cost for a roof water collection system is being planned.

3. The quality of roof water is definitely acceptable for nonpotable purposes. While the potential volume is a sufficiently attractive proposition, the quality levels are also of a high order especially when this source is compared to other existing sources where the dissolved solids levels are quite high but well within International Standards (WHO 1971, pp. 38-40) for potable water.

In locations where such high dissolved solid levels exist, some industries have to resort to further treatment before they can use the water for manufacturing purposes. In such cases, the trade-off lies between the cost for additional treatment to be provided for the existing water supply and the associated costs for a roof water collection system. There is evidence that for some local manufacturers the installation of roof water collection systems has resulted in considerable savings, both in terms of treatment costs and volume of water used.

4. In subtropical regions like Singapore especially where water is stagnant, mosquitos are ubiquitous. They are in general a nuisance and a health

hazard in varieties such as, *Aedes aegypti* (Chang, Ng, and Chew 1977), a transmitting vector of the often lethal dengue haemorrhagic fever. Thus, it is imperative that, in any type of roof water collection, a proper device (such as a fine-mesh screen) be incorporated into the inlet pipes to the storage cistern to ensure that neither eggs nor larvae of the mosquito can enter the stored roof water.

5. The setup of the roof water cistern as envisaged will entail a cross-connection between the potable and nonpotable sources of water. This is a potential health hazard as per Public Utilities Act (Public Utilities Board 1977) which stipulates that it is mandatory that such cross-connections should not be allowed. This aspect of water pollution should be looked into further before planning to embark on a large-scale implementation of such dual modes of water supply.

#### REFERENCES

- Chan, K.L.; Ng, S.K.; and Chew, L.M. 1977. The 1973 dengue haemorrhagic fever outbreak in Singapore and its control. *Singapore Medical Journal* 18(2):81-93.
- Dhruva Narayana, V.V. 1979. Rain water management for lowland rise cultivation in India. *J. Irrig. Drain. Div., Am. Soc. Civ. Eng.* 105(IR1):87-98.
- Fok, Y.S.; Fong, R.H.L.; Hung, J.; Murabayashi, E.T.; and Lo, A. 1980. *Bayes-Markov analysis for rain-catchment cisterns*. Tech. Rep. No. 133, Water Resources Research Center, University of Hawaii, Honolulu.
- Hazen, A. 1892. A new color standard for natural waters. *Am. Chem. J.* 14:30.
- Hazen, A. 1896. The measurement of the colors of natural waters. *J. Am. Chem. Soc.* 18:264.
- Public Utilities Board. 1977. Public Utilities Act. In *The Public Utilities Board (Water Supply) Regulations*, chap. 211, Gazette No. 25, No. S126, Clause 10(3), p. 257.
- Public Utilities Board. 1979. Handbook on application for water supply. Water Department, Public Utilities Board, Singapore. 4 p.
- Standing Technical Committee Reports. 1980. *Leakage control policy and practice*. No. 26, Dept. of the Environment, National Water Council, 1 Queen Anne's Gate, London, United Kingdom. 38 p.
- World Health Organisation. 1971. *International standards for drinking water*. Geneva, Switzerland.

## RAIN WATER CISTERN SYSTEM IMPACT ON INSTITUTIONAL POLICY

Yu-Si Fok, Professor  
 Department of Civil Engineering  
 and Researcher  
 Water Resources Research Center  
 University of Hawaii at Manoa  
 Honolulu, Hawaii 96822, USA

### INTRODUCTION

The adaptation of the rain water cistern system will have a definite impact on institutional policy. To promote the adaptation of this type of system, Fok and Murabayashi (1979) indicated that, in water shortage areas, some incentive measures—such as tax credits—would produce results and require a new institutional policy.

Another impact is related to cistern water quality, which is a matter of concern to many public health officials. Because the cistern catchment area could be polluted by natural or artificial pollutants, the rain water collected and stored in the cisterns may not be fit for human consumption. Therefore, Fok (1980) reported that in California a ruling was made that prohibited the use of roof-catchment cistern water for drinking or for other human consumption uses.

Because rain water cistern systems are considered structures, the safety of these systems is another matter of concern. Thus, their impact on existing building codes, which may not be applicable to cisterns, imposes another impact on institutional policy.

The impact of cistern systems on institutional policies and their acceptability to users requires investigation. In this paper, examples of rain water cistern system impacts on institutional policies are discussed and presented as suggestions for further investigation and consideration.

### OHIO DEPARTMENT OF PUBLIC HEALTH RULES ON PRIVATE WATER SYSTEMS

In Chapter 3701-28 (12 September 1980), a permit for a private water system will be issued where all requirements have been met. Sections of this law include:

- Inspection (water sample collection and bacteriological analysis)
- Approval to enforce
- Fee
- Abandonment of test holes, wells, and cisterns
- Cross-connection and backflow
- Disinfection
- Location, operation and maintenance of private water systems
- Miscellaneous provisions for the construction of private water systems
- Construction and surface design of cisterns, hauled water storage tanks, and roof washers

Construction and surface design of springs  
 Location and construction of pond piping  
 Startup and operation of new, repaired, and altered private water systems  
 Hauled water  
 Order to improve water systems  
 Variance or waiver of certain provisions of this chapter  
 Effect of partial invalidity.

In the state of Ohio, there are today more than 63,000 privately owned water systems, most of which are farm ponds that collect and store rain water for private domestic uses. Since this practice of private water systems was established long ago, the institutional policy in Ohio seems only protective of the general health of users. No incentive measures, such as tax credits, were included to encourage rain water conservation and utilization.

#### CALIFORNIA WATER CONSERVATION TAX CREDIT PROGRAM

During the 1976 to 1977 drought, residents in the Monterey Peninsula and other areas started to use cisterns to store grey water and to supplement it with rain water cisterns to maintain their gardens and lawns. On 26 January 1979, a one-day symposium on rain water cisterns was conducted at the Monterey Peninsula College. Tax credits as an incentive measure for rain water conservation was discussed by Fok and Murabayashi (1979) and other participants. In July 1980, the California Assembly Bill 1150, authored by Assemblyman William Filante (1980), was signed into law as Water Conservation Tax Credit Law by the governor of California. This law provides for a 55% tax credit of up to \$3,000 for the implementation of grey water or rain water cistern, subject to the approval of state and local public health authorities, and for the installation of water conservation features, such as low capacity toilet tanks and flow reduction pressure shower heads. This tax credit is subtracted from the amount due to the state of California. California's Water Conservation Tax Credit Law (Bill 1150) is the first bill in the United States that applies institutional policy to encourage water conservation and reuse.

#### IMPACT ASSESSMENT

An impact assessment of the Ohio and California institutional policies on rain water cistern systems is summarized as follows.

1. Impact on Public Health. In Ohio, water treatment guidelines were developed for private water supply systems because farm ponds are used as the source of water supply. In California, regulations for rain water and grey water differ from the public water supply system because grey water is used for landscape maintenance, and rain water is only collected to supplement the grey water supply. Basically, Ohio and California regulations safeguard drinking water standards, and their water policies are geared to water use. Whenever the water environment changes, one can expect the institutional policy to change accordingly.
2. Incentive Measures. At this time, Ohio has no institutional policy to encourage the development of rain water cistern systems because



farm ponds have long been used as sources of private water supply. Consequently, there has been no need to encourage supplemental sources of water supply. On the other hand, in California where water shortage is a problem, rain water cistern systems were recently in the Monterey Peninsula to alleviate drought conditions. From the point of view of California State water resources planners, the practice of water conservation and water reuse has become a necessity. Thus, incentive measures were incorporated in the institutional policy to encourage water conservation and water reuse. The effectiveness of the tax credit incentive measure will be subject to review so that an updating of the tax credit program can be made in 1982.

Based on the above analyses, the following simple systems analysis diagram illustrates the impact of rain water cistern systems on institutional policies.

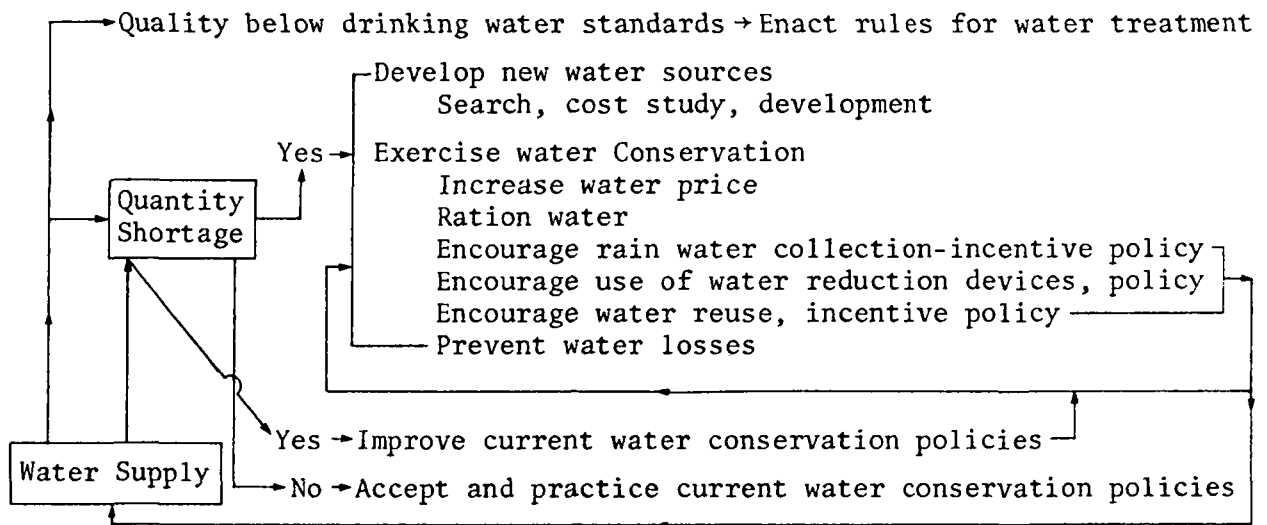

From this simple diagram, one can see that the feedback routine in the flow chart plays an important role in the assessment of the effectiveness of incentive policies in water conservation. Thus, rain water collection cistern systems should also pass the assessments on cost analysis, dependability (risk analysis), and operation study. The adaptation of rain water cistern systems in a community would depend considerably on the acceptance of the incentive policy by the public sector. A tax credit is a powerful tool to encourage the private sector to conserve water and to practice water reuse.

Water resources decision makers can contribute a great deal to institutional policy making because they are professionals who by training know water supply and demand conditions and are responsible for water resources management. Thus, law makers depend on their expertise and recommendations to develop institutional water policies.

### FUTURE INSTITUTIONAL POLICY

After an assessment on the impact of rain water cistern systems, the next step is the question of the future of institutional policy, such as the follow-

ing aspects of possible future policies.

1. **Building Code.** Cisterns are structures built to store considerable amounts of water. Thus, from the viewpoint of public safety, a new building code regulation should be included for cistern structures and for covers to prevent accidents (drowning) in the cistern.
2. **Cisterns as Part of Housing Projects.** Just as solar heaters are being installed as part of multi-unit apartment buildings to conserve energy, the conservation and reuse of water should be also considered as another factor in housing developments. Perhaps sometime in the near future, housing developments will include or promote the idea of self-sustaining, rain water collecting cistern systems as a standard practice in housing development projects. Developers of housing projects would very likely comply with specifications established by the Federal Housing Administration (FHA) to build water catchments cistern to qualify for lower mortgage loans.
3. **Cistern Regulation.** More inclusive regulations on cistern water quality could be introduced.
4. **Tax Credits.** To alleviate urban water shortage problems, tax credits may be offered. To do this, the following subjects are presented.
  - a. Increasing water price may not be an effective water conservation measure because water prices are still relatively low—in comparison to the constant increases in gasoline prices which do not result in energy conservation.
  - b. Rationing water cannot be used as an effective way to encourage water conservation, and will only be accepted during an emergency, such as drought or accidental breaks in the water supply system.
  - c. Water reuse is already practiced in many places, including Hawaii. In Oahu and Maui, treated waste water is recycled to irrigate sugarcane and some golf courses. Grey water has been used for lawn irrigation in Monterey, California. New rules or laws can be introduced to make the reuse of treated waste water an acceptable practice, especially when seasonal water shortages become a frequent event and treated waste water can be recycled for non-domestic uses, such as irrigation water. As the requirement for safe disposal of treated waste water becomes more restrictive, additional regulations are bound to be developed.
  - d. Water conservation devices, such as pressure reducers, flow-rate reducers, and storage volume restrictions in toilet tanks, are being encouraged and practiced by homeowners. Regulations on the quality of these devices may be also made.

#### INTERNATIONAL INSTITUTION POLICY

The United Nations' Drinking Water Supply and Sanitation Decade (1981-1990) is an international institutional policy to provide safe drinking water and the safe disposal of human wastes by the year 1990. International policy in general is not enacted into law; however, because this particular policy

has been debated for years and was finally accepted by the UN General Assembly, it has all the characteristics of an institutional policy.

To reduce the \$300 billion (U.S.) estimated cost of developing a drinking water supply, the United Nations worked through the World Health Organization and the World Bank to promote the use of appropriate technology to assist developing countries to develop their drinking water supply.

Rain water catchment-cistern system trials under this technology assistance have been started in many countries, for example, the West Jarkhata project reported on by several participants at this conference. This particular project is trying to determine the most economical and practical cistern construction that can be used in other countries of the world. As reported by the World Bank, the \$300 billion appropriation to finance the drinking water supply for more than 100 developing countries is inadequate and, therefore, the reduction of this cost is urgently needed. One measure suggested is presenting the inventor with an award. In September 25, 1977, the Swedish Inventors' Association declared their program an "International Inventor Awards-1986" for four target areas: reforestation, low-cost energy, simple devices for uses in water resources, and low-cost processes of local resources. Under the target area of water, they listed some examples for award consideration:

1. Systems and materials for water storage
2. Pumps powered with local sources of energy
3. Low-cost, temper-proof water meters
4. Development of salt-tolerant plants and brackish water irrigation
5. Simple desalination methods and equipment with high energy yield.

Perhaps the same program can be established for the United Nations Decade for Drinking Water Supply and Sanitation. The awards can be presented on an annual or biannual basis, and based on goals related to the UN Decade. The award would be an attractive incentive for innovative measures or devices to reduce the \$300 billion cost and would help alleviate a universal problem. If this amount can be reduced 90% to \$30 billion, the amount set aside for awards would be a beneficial investment.

#### CONCLUSIONS

As presented in this paper, the following conclusions are summarized.

1. Institutional policy on rain water cistern systems generally reflects the purpose of the system to users. For example, public health and safety are the main concerns of one example cited for the state of Ohio, while the promotion of water conservation and protection of the existing water supply is cited for the state of California.
2. Incentive measures can be incorporated in the institutional policy to promote the development of rain water cistern systems for water conservation, such as the California Water Conservation Tax Credit Law.
3. The systems analysis approach can be used to develop institutional policy and the subroutine feedback may be very useful.
4. A building code for rain water cistern systems may be developed in the future when this system becomes popular.

5. When water shortage problems persist, more water conservation tax credits may be offered to alleviate the shortage problem.
6. An award system can be used by the United Nations for the invention of low-cost drinking water development techniques, drinking water collection and storage devices, and low-cost sanitation equipment for the safe disposal of human wastes. New methods are needed to cut down the estimated cost to meet the goal of the Drinking Water Supply and Sanitation Decade (1981-1990).

#### REFERENCES

- Filante, W. 1980. California Assembly Bill 1150. California State Legislature, Sacramento, California, July 1980.
- Fok, Y.S. 1980. Trade off between private rainwater cisterns and public water supply systems. In Proc. Int. Conf. Water Resources Development, IAHR, AIRH, CIE, and CICHE, in Taipei, Taiwan, Republic of China, May 1980, vol. III. (In press)
- Fok, Y.S., and Murabayashi, E.T. 1979. Past, present and future of rainwater cistern systems. Invited paper presented to the Rainwater Cistern Symposium, at the Monterey Peninsula College, Monterey, California, 26 January 1979.
- Department of Public Health. 1980. Rules on private water systems. Chap. 3701-28, State of Ohio, 12 September 1980.

## QUALITY OF THE ST. THOMAS, U.S. VIRGIN ISLANDS HOUSEHOLD CISTERN WATER SUPPLIES

G. Fred Lee, Professor  
Department of Civil Engineering  
Colorado State University  
Fort Collins, Colorado 80523, USA

R. Anne Jones, Res. Asst. Professor  
Department of Civil Engineering  
Colorado State University  
Fort Collins, Colorado 80523, USA

### ABSTRACT

A study was conducted in December 1972 to determine the characteristics of individual household cistern water supplies located on St. Thomas in the U.S. Virgin Islands. Twelve cistern supplies as well as several other water sources, including the domestic water supply for Charlotte Amalie, St. Thomas and several well water supplies, were sampled. Measurements were made of specific conductance, alkalinity, pH, Ca, Mg, Na, K,  $\text{Cl}^-$ ,  $\text{SO}_4^{2-}$ , total P,  $\text{NO}_2^-$ ,  $\text{NO}_3^-$ ,  $\text{NH}_4^+$ , organic N, F, Zn, Ca, Cd, Pb, Cr, Ni, Fe, Mn and Hg. It was found that all of these contaminants' concentrations were below U.S. EPA water quality criteria except for Hg, whose concentrations exceeded the U.S. EPA regulations.

Individual household cistern water supplies did not appear to be contaminated to a significant extent by materials of construction or painting of the rooftop collection system. While the chemical characteristics of the cistern water supplies were in general satisfactory in terms of drinking water quality, other studies have shown that these systems tend to be contaminated with fecal coliforms and that large amounts of decomposing organic materials, such as leaf litter, tend to accumulate in the storage tank. A recommended maintenance program is presented, which includes disinfection with chlorine, periodic removal of accumulated debris from the bottom of the tank, and periodic sampling for measurement of sanitary and chemical quality.

### INTRODUCTION

St. Thomas, a Caribbean island in the U.S. Virgin Islands, relies on a variety of sources for its domestic water supply. In the early 1970s, these sources included wells on the eastern part of the island, three desalinization plants, water barged from Puerto Rico, and a large number of individual household cistern systems. At one time, large municipal cisterns were operating; however, these systems have not been maintained and were not functioning at the time of this study. In December 1972, water samples were collected from a number of household cisterns as well as from the other sources of domestic water on the island. This paper presents the results of the chemical and other analyses done on these samples and discusses the potable and palatable quality of household cistern water supplies for domestic use.

### CHARACTERISTICS OF ST. THOMAS

St. Thomas is 4.8 km (3 miles) wide and 19 km (12 miles) long. It has a backbone ridge of mountains which rise to approximately 457 m (1500 ft) above sea level. The climate of St. Thomas is essentially marked by constant east-

erly trade winds and maximum average temperatures about 27°C (80°F) in the winter and 30 to 32°C (87-89°F) during the summer. Average relative humidity is above 80%. Rainfall frequently occurs in the form of brief showers, with the higher elevations on the island tending to receive greater amounts of rainfall, on the order of 102 to 152 cm (40-60 in.) per year. Average monthly rainfall for the months of December through June is 5 to 7.5 cm (2-3 in.), while for July through November it is on the order of 10 to 12.5 cm (4-5 in.).

#### CHARACTERISTICS OF INDIVIDUAL HOUSEHOLD WATER SUPPLIES

Many of the homes on St. Thomas are constructed in such a way that all or at least a substantial part of the roof collects rain water and transports it to storage tanks located within or below the house. Debris that collects on a roof accumulates in the storage tank along with the rain water. The water from this tank is used to meet household needs; however, some residents find that for a variety of reasons, the cistern water supply is inadequate to meet the needs of the household. Supplemental water can be purchased from a private water supplier who delivers water via truck to the cistern systems. The trucked water was, at the time of this study, derived primarily from wells that had been found to have elevated coliform counts, even though the water from these wells was chlorinated. The private, trucked water also distributed at times desalinated water.

Discussions with the Director\* of Environmental Health for St. Thomas revealed that, in 1973, a single-family dwelling on St. Thomas had to have a cistern storage tank with a 3.5  $\ell/m^2$  (10 gal/ft<sup>2</sup>) of roof. Federal Housing Administration (FHA) guidelines at that time stated that a single-family dwelling should have a 45,020- $\ell$  (12,000-gal) cistern. According to Francois, there were no restrictions on the composition of the cistern-roof collection systems or their paint. The cistern tanks were composed of various materials, including painted and unpainted concrete, galvanized metal, and sheet rubber-lined concrete. The existing roof collection systems also widely varied in their construction and composition. Some were galvanized iron, usually painted with red lead paint within a few years after construction. Others were terra-cotta tile, concrete, or plywood covered with tar paper and coated with hypoline. The roofs of many of the newer homes were constructed of fiberglass-descoe which was periodically painted.

A visit to the local hardware stores at that time showed that there were two types of paint used frequently for roofs on this island. One was an "asbestos fiber liquid aluminum" paint containing 4% asbestos and about 18% titanium dioxide. The other paint used frequently contained zinc oxide or tributyl tin oxide for controlling mildew. There has been some concern in the past about the use of paints containing mercury on roofs that are part of roof-cistern systems. The results of studies on this topic will be subsequently presented in this paper.

Francois indicated that checks made by the Environmental Health Department had found that many of the household cistern water supplies contained a "large" number of coliform bacteria. According to him, the Environmental Health Department's position was to inform the residents using cistern water

\*Pedrito Francois 1973: personal communication

supplies that such water was not considered potable. The elevated number of coliforms present would be expected, because individual household waste disposal systems were septic tanks, many of which failed, resulting in untreated waste waters coming to the surface and running down the hillside. Birds and other animals such as mongooses, could readily transport fecal coliforms from the domestic sewage on the surface of the ground to the roof-cistern collection systems.

Visual inspection of the cisterns in some households revealed that there were a few centimeters to as much as half a meter of sludge in the bottom of the cisterns. This sludge consisted largely of plant debris which had been washed in from the roof collection system. A chlorine demand study was conducted by the authors on one of the cisterns which had been in operation for about three years and contained a few centimeters of organic sludge on the bottom. To determine if it would be possible to readily maintain a chlorine residual by periodically dosing the system with household bleach (Clorox), a simple experiment was run. Each day for a week the water in the storage tank was dosed with chlorine so that at night it contained 3 to 5 mg  $\text{Cl}^-/\ell$ . Each morning the chlorine residual, as determined using a swimming pool test kit (orthotolidine procedure), was less than 0.1 mg/ $\ell$ , even after one week of treatment. As expected, the organic debris that had accumulated as a flocculated sludge on the bottom of the tank was exerting a high chlorine demand.

It is evident that the individual household cistern water supplies on St. Thomas, and most likely elsewhere, are subject to potentially significant contamination with a variety of materials, including fecal materials transported from improperly constructed and managed septic tanks by birds and other animals; leaf and other litter, debris, and dustfall; and materials used in roof construction and maintenance, such as paint. Further, in the case of St. Thomas, because of the inadequacy of the cistern system to provide for the total water needs of some families, contamination of the household water supply could readily occur through water purchased from the local, private water purveyor.

#### SAMPLING AND ANALYTICAL PROGRAM

Twelve private home cistern supplies covering each part of the island were selected for study. The sampling procedure involved allowing the kitchen sink faucet to run for about one minute, then collecting one liter of water from this faucet in a plastic bottle. Samples were transported from St. Thomas to Madison, Wisconsin where they were analyzed utilizing procedures described in Standard Methods (APHA, AWWA, and WPCF 1971). Heavy metals were determined by atomic absorption spectroscopy, using the APDC-MIBK procedure (Fishman and Midgett 1968). All values reported in this study are for the total element or compound content.

In addition to individual home cistern water supplies, several public and private wells were sampled, as well as the municipal water supply for Charlotte Amalie, the principal city on St. Thomas. This city receives water from two sources: one is the three desalinization plants, the other is barged water from Puerto Rico. The barged water is from the Roosevelt Road Navy Base (U.S.), which originally came from the Rio Blanco River on the east coast of

Puerto Rico. According to a staff member\* of the Environmental Quality Board of Puerto Rico in San Juan, the Rio Blanco water is purified by coagulation with alum, fluorinated, and chlorinated. The barged water is supposed to be mixed with the desalinated water in a ratio of one part barged water to nine parts desalinated water. The League of Women Voters of St. Thomas (1970) brochure indicates that the demand for fresh water on St. Thomas averaged 144 mgd, 68% of which was provided from the three desalinization plants that exist on the island. At the time of sampling in December of 1972, these desalinization plants were producing only about 2.5 mgd. Since the desalinated water and the water barged in from Puerto Rico were likely to be of markedly different chemical composition, the composition of the domestic waters of Charlotte Amalie could be somewhat variable. It is not known how representative the various samples taken from this city's water supply system were of the water normally found there.

## RESULTS

Table 1 presents the results of the chemical analyses of the cistern and other water supplies on St. Thomas. To determine the potable and palatable quality of these waters, a compilation of existing U.S. EPA water quality criteria and regulations was developed (Table 2). The sources for the concentration limits presented in Table 2 are the National Academy of Sciences and National Academy of Engineering (1973) "Blue Book" of water quality criteria, the U.S. EPA (1976a) "Red Book" of water quality criteria, the U.S. EPA (1974, 1975, 1976b) Safe Drinking Water Act regulations and the U.S. EPA (1980) Water Quality Criteria (toxic chemicals) of November 1980. In general, the most recently revised criterion is presented in Table 2 for each parameter. A critical comparison of Tables 1 and 2 for each of the parameters is presented below, with particular emphasis given to the characteristics of the household cistern water supplies.

pH. The recommended pH range for domestic water supplies, based on welfare characteristics such as minimizing corrosion and scale formation, is 5 to 9. All of the water samples collected had acceptable pH values.

DISSOLVED SOLIDS. It is generally accepted that dissolved solids levels above 500 mg/l in domestic water supplies is undesirable. For the dissolved solids-related parameters such as chloride and sulfate, the maximum recommended concentrations are 250 mg/l. Examination of Table 1 shows that the concentrations of chloride and sulfate were below the recommended limits. While dissolved solids were not measured for the water samples, they may be estimated through specific conductance values. It is generally found that specific conductance in  $\mu\text{mhos/cm}$  at 20°C multiplied by 0.7 approximates the dissolved solids content of the water in mg/l. Using this approach, all household cisterns except number 10 and the domestic water supply for Charlotte Amalie were below the 500 mg/l dissolved solids suggested acceptable limit (U.S. EPA 1976a). The well water samples, however, were all in excess of this limit. The water in the well used for the private, water supply trucking system, had an estimated dissolved solids of about 1100 mg/l. This well, as well as some other wells on the island, was experiencing some salt-water intrusion

---

\*I. Sanchez 1971: personal communication.



TABLE 1. CHEMICAL AND OTHER CHARACTERISTICS OF CISTERN AND OTHER WATER SUPPLIES FOR ST. THOMAS, VIRGIN ISLANDS

TYPE OF SUPPLY	SPEC. CONDUCT. pH	ALK. AS CaCO <sub>3</sub> /cm @ 20°C	Ca	Mg	Na	K	Cl	SO <sub>4</sub>	T-PO <sub>4</sub> AS P	NO <sub>2</sub> + NO <sub>3</sub>	NH <sub>4</sub> <sup>+</sup>	ORG N	F	HEAVY METALS									
														Zn	Cu	Cd	Pb	Cr	Ni	Fe	Mn	Hg	
----- (mg/l) -----													----- (µg/l) -----										
Public Water Supply																							
Charlotte Amalie																							
West Part of City	7.6	610	11.4	8.1	2.9	24	0.8	57.2	9.8	0.075	<0.05	<0.05	<0.05	<0.05	104	3.6	0.2	<1	<4	1.4	16	<5	2.7
Savan Street Faucet	8.5	200	11.8	9.2	3.3	28	0.5	54	8.5	0.28	<0.05	<0.05	0.25	0.1	1	6.7	<0.2	<1	<4	0.9	110	<5	3.0
Storage Tank Savan	7.1	290	45.6	22.7	3.4	34	3.5	53	8.5	0.34	0.27	<0.05	0.14	<0.05	116	5.8	0.6	<1	<4	1.2	4	<5	0.4
Private Well Used for Private Water Supply																							
East End of Island																							
	7.4	1600	400	73	43	240	1.5	183	37	0.04	2.5	<0.05	0.14	0.82	4	3.5	0.5	<1	<4	<0.5	<1	<5	~12
Government of Virgin Islands Dorheu Station Well & Cistern																							
	8.1	840	298	19	7	176	0.7	103	31	0.09	0.92	<0.05	<0.05	0.26	133	0.7	0.9	1	<4	<0.5	<1	<5	1.6
North Side of Island—Well Only																							
	8.0	1150	369	15	9.5	208	0.4	58	36	0.08	<0.05	<0.05	<0.05	0.37	19	4.3	0.2	<1	<4	<0.5	<1	<5	0.8
Private Home Cistern Supply																							
No. 1	8.2	200	213	28	17	202	1.8	80	14.2	0.2	1.1	<0.05	<0.05	0.25	>150	35	3.2	7	<4	10.6	84	21	0.8
2	7.1	110	42	11	0.9	5.7	0.2	8.2	5.0	0.07	0.13	<0.05	0.06	<0.05	22	4.0	<0.2	<1	<4	<0.5	<1	<5	0.3
3	7.0	79	26.6	10.1	0.5	4.9	<0.1	10.5	3.1	0.04	0.1	<0.05	<0.05	<0.05	54	4.5	0.7	<1	<4	<0.5	<1	<5	3.2
4	6.8	60	22	8.5	0.4	3.6	<0.1	9.7	2.6	0.026	<0.05	<0.05	<0.05	<0.05	3	2.2	0.6	<1	<4	0.9	110	<5	0.6
5	6.8	94	30	5.0	1.6	9.9	<0.1	16.1	2.2	0.08	0.1	<0.05	0.2	<0.05	115	~160	0.6	2.4	<4	0.6	<1	<5	2.2
6	7.0	90	35	8.2	0.4	9.2	0.8	9.8	4.3	0.06	0.15	<0.05	0.2	<0.05	15	13	1.6	<1	<4	0.6	3	<5	1.3
7	6.9	92	40	13.4	0.9	5.2	0.2	9.1	3.5	0.03	<0.05	<0.05	0.09	<0.05	10	7.7	0.6	<1	<4	1.2	3	5	0.6
8	7.0	69	27	5.6	0.2	9.2	1.4	8.0	3.6	0.04	0.1	<0.05	0.14	<0.05	<1	<0.5	0.2	<1	<4	<0.5	<1	<5	0.3
9	6.7	88	19	6.5	1.4	8.8	<0.1	19.7	4.0	0.06	0.12	<0.05	0.2	<0.05	1.4	11.2	0.7	<1	<4	1.2	3	5	4.3
10	7.6	1400	485	38	34	220	1.7	171	36	0.006	1.8	<0.05	0.31	0.6	57	16.7	0.2	<1	<4	<0.5	<1	<5	0.7
11	7.0	92	36	7.4	1.6	10.2	<0.1	13.4	0.5	0.03	0.1	<0.05	0.2	<0.05	15	7.0	0.3	<1	<4	<0.5	19	<5	0.5
12	6.2	435	9	1.5	0.6	4.4	<0.1	11.1	3.5	0.04	<0.05	<0.05	0.09	<0.05	154	11.2	0.8	1.1	<4	<0.5	20	<5	0.5

TABLE 2. DRINKING WATER GUIDELINES AND REGULATIONS

Parameter	Max. Conc.	Reference*
pH (range)	5-9	1
Specific conductance ( $\mu\text{mhos/cm}$ ) (dissolved solids, mg/l)	350 (500)	1
Alkalinity (mg/l as $\text{CaCO}_3$ )	>400	1
Hardness (Ca and Mg) (mg/l as $\text{CaCO}_3$ )	>150 ?	-
Na	none	-
K	none	-
Chloride (mg/l)	250	1
$\text{SO}_4^{2-}$ (mg $\text{SO}_4^{2-}/\text{l}$ )	250	1
Total $\text{PO}_4$	none	-
$\text{NO}_2^- + \text{NO}_3^-$ (mg N/l)	10	3
Ammonia (mg N/l)	0.5	4
Organic N	none	-
$\text{F}^-$ (mg/l)	1.4	3
Zn (mg/l)	5	2
Cu (mg/l)	1	2
Cd ( $\mu\text{g}/\text{l}$ )	10	2
Pb ( $\mu\text{g}/\text{l}$ )	50	2
Cr ( $\mu\text{g}/\text{l}$ )	50	2
Ni ( $\mu\text{g}/\text{l}$ )	13.4	2
Fe (mg/l)	0.3	1
Mn ( $\mu\text{g}/\text{l}$ )	50	1
Hg ( $\mu\text{g}/\text{l}$ )	2	3

\*1 = U.S. EPA (1976a); 2 = U.S. EPA (1980); 3 = U.S. EPA (1976b); 4 = NAS, NAE (1973).

which would account for the large amounts of dissolved solids present in the water. A 1965 study conducted by the U.S. Geological Survey (1965) reported that the quality of groundwaters on St. Thomas ranged from fair to poor, with dissolved solids content averaging about 1200 mg/ℓ. The USGS found chloride concentrations to range from 85 to 2425 mg/ℓ, with most wells having less than 300 mg/ℓ chloride.

The cistern water supply number 10 was located on the extreme eastern end of the island in Secret Harbor. This particular residence purchased a significant amount of the private water supply well water which accounts for the high dissolved solids found in this particular cistern. It appears that most of the household cistern supplies which used little or no well water supplement had specific conductance values on the order of 60 to 100  $\mu$ mhos/cm. This is approximately equivalent to 50 mg/ℓ dissolved solids. While this level of dissolved solids in rainfall would be high for inland continental U.S., it is not out of line with that expected for U.S. coastal regions. These elevated dissolved solids values are due to sea salts present in rainfall in coastal areas.

**CALCIUM, MAGNESIUM, SODIUM, POTASSIUM.** The Ca and Mg concentrations (hardness) of the water supply systems were within the acceptable range for domestic water supplies. The cistern water supplies that were not receiving significant amounts of the private water supply well water, as well as the Charlotte Amalie waters, would all be considered soft water and would tend to be somewhat corrosive. The well waters, on the other hand, especially the private well, would be considered hard water. The Na and K concentrations in all waters investigated were satisfactory for domestic water use.

**PHOSPHATE.** There are no regulations in the U.S. for phosphate in domestic water supplies. Concentrations well above those found in any of the supplies could readily be present without adversely affecting water quality. While not of concern with respect to domestic water use, it is interesting to note that the cistern water supplies all contained total phosphorus concentrations well above that necessary to cause eutrophic conditions in lakes and impoundments. The source of at least part of the phosphorus in some of the cistern supplies was most probably bacterial decomposition of the organic sludge at the bottom of the storage tank. It is likely that part of the total phosphorus measured after ammonium persulfate digestion would be unavailable to support algal growth. Measurement of soluble orthophosphate would have to have been made to determine the amount of total P in the precipitation or storage tank that was available to support algal growth.

**NITROGEN COMPOUNDS.** The concentrations of nitrite and nitrate nitrogen and ammonia in all samples were well below any critical concentrations for domestic water use. While there are no standards for organic N in domestic drinking water, the low concentrations of organic N found would not represent a problem for the use of these waters for domestic purposes. Examination of the concentration ratios of the sum of the inorganic nitrogen compounds to total phosphate in the one cistern water supplies shows that from a lake and impoundment eutrophication-potential point of view, the water bodies receiving primarily rain water would tend to become nitrogen limited if an appreciable part of the total P were available to support algal growth. This is typical of what is found in west coast regions of the continental U.S. As air masses move across land they tend to accumulate more nitrogen relative to phosphorus,

causing inland water bodies to become more likely to be phosphorus limited. The nutrient contributions from atmospheric sources can be important in determining surface impoundment water supply raw water quality. These concepts are discussed in detail by Lee, Jones, and Rast (1981), and Lee and Jones (1981).

**FLUORIDE.** The fluoride content of all of the waters tested was significantly below the 1.4 mg/ℓ fluoride level that the U.S. EPA (1976*b*) recommends as a maximum for the type of climatic regime that exists on St. Thomas. In some cases, the concentrations are sufficiently low as to provide no reduction in dental cavities of children who would consume this water.

**HEAVY METALS.** The concentrations of zinc, copper, lead, chromium, nickel, cadmium, iron, and manganese were all below the U.S. EPA's recommended concentration limits for public water supplies. The only heavy metal whose concentration was above the U.S. EPA's recommended level was mercury. The U.S. EPA (1976*a*) recommended a limit of 2 µg/ℓ mercury in domestic drinking waters, which was adopted by the U.S. EPA (1976*b*) as a national interim drinking water primary standard. Several samples of water from St. Thomas that were analyzed, contained mercury in excess of this value. These included two of the three samples taken from the Charlotte Amalie water system. The private well had the highest concentrations of mercury, approximately 12 µg/ℓ. Some of the home cistern waters also had concentrations of mercury above the 2-µg/ℓ limit adopted by the U.S. EPA (1976*b*). These elevated concentrations are probably due to the fact that these households purchased well water to supplement their cistern supplies. However, it should be noted that the mercury values found in the home cistern waters and the Charlotte Amalie water supply were just above the 2-µg/ℓ value. Additional samples should have to be collected to determine whether the concentrations found in the cisterns and the Charlotte Amalie water supply were consistently in violation of the U.S. EPA mercury drinking water regulation. Therefore, it is concluded that of all the parameters tested, mercury is the only one that represents a potential chemical hazard to people who use the water supplies on St. Thomas. It appears that from this point of view the cistern water supplies are not significantly different from the other supplies.

There was some concern, previous to this study, about mercury in water supplies on St. Thomas. The U.S. Public Health Service (Klein 1971, 1972) conducted a study of the mercury content of cistern water supplies in 1971 and found mercury in the cistern water supplies at levels less than 4 µg/ℓ, which was the detection limit for the atomic absorption analytical procedure used. Unfortunately, this detection limit, while adequate for the accepted critical concentration of mercury in drinking water at the time of his study (5 µg/ℓ), would not be acceptable today when the critical concentration named by NAS and NAE (1973) in 1972 was 2 µg/ℓ, which is the same value as the U.S. EPA limit for drinking water that is in effect today. Therefore, the Klein data provide little in the way of useful information on the potential water quality problems of mercury since concentrations found cannot be defined relative to the currently applicable limit for mercury.

#### OVERALL QUALITY OF CISTERN DOMESTIC WATER SUPPLIES ON ST. THOMAS

From an overall point of view, the household cistern water supplies on St. Thomas had chemical characteristics which were essentially the same as the

municipal systems and far better than some of the private systems drawing well water. In general all sources conformed to the U.S. EPA drinking water regulations for essentially all parameters measured. The private well water system that was used to supplement household cistern supplies was found to be highly contaminated with mercury. If further studies show that the data for this study are representative, water from this source should not be distributed without treatment for mercury removal. Based on the parameters measured, no discernible problems were found with heavy metals or other contaminants in the cistern supplies that could be traced back to the characteristics of the system. One of the cistern supplies that had slightly elevated concentrations of mercury had terra-cotta tile on the roof collection area. This household also purchased appreciable amounts of the private well water which had the elevated mercury content. It appears that the rate of leaching of heavy metals and other materials used in construction and upkeep of the cistern collection system was sufficiently low at the time of sample collection so as to not significantly contaminate the cistern water.

It is important to emphasize that this study did not include an investigation of the sanitary quality of the cistern water supplies. According to local health authorities, the sanitary quality is poor.

Based on this study, a number of practices for the use of household cistern water supplies are recommended and enumerated below.

1. Every household with a cistern water supply should practice chlorination of their cistern storage water; sufficiently strong solutions of chlorine, such as Clorox, should be added to the cistern each night so that the residual total chlorine the next morning is on the order of 0.5 mg  $\text{Cl}^-/\ell$  or greater, based on measurements with a DPD chlorine colorimetric test kit. New cistern water supply systems should be constructed to facilitate the addition of chlorine to the storage tanks. One way to accomplish this would be to provide plastic piping which would allow the addition of chlorine from the main part of the house and which would preferably distribute the chlorine to several locations within the tank. A water depth indicator in the cistern supply tank would also be desirable to aid in determining how much chlorine is needed. It is realized that the addition of chlorine in this manner will increase the trihalomethane content of the cistern water supply. However, in the opinion of the authors, the health risk of the increased trihalomethane concentrations is small when compared to the risk of promoting enteric diseases if the chlorine were not added.

2. At about yearly intervals, and more frequently if necessary, a substantial part of the leaf debris sludge present in the bottom of the cisterns should be carefully siphoned off or pumped out with a flexible hose so as not to drain the tank. If excessive amounts of debris accumulate, necessitating frequent cleaning, then all trees and shrubbery that tend to overhang the rooftop collection area should be removed from that area. If leaf fall is a problem, it may be appropriate to place screens on the intakes. These screens would have to be cleaned at frequent intervals to make certain that they did not impair water collection.

3. Paint used for rooftop collection systems should have as low a level as possible of heavy metals, such as mercury and lead. During the time of painting and until the paint is thoroughly dry, any rain water that should

fall on the collection surface should be diverted to the ground. Local health authorities should investigate and develop a list of appropriate paints that may be used for cistern collection systems.

4. Initially at quarterly intervals, and eventually at semiannual to annual intervals, the local health authorities should provide low-cost testing of the sanitary quality of each cistern supply. If the cistern supply is found to contain fecal coliforms in excess of one fecal coliform organism per 100 ml of water, the amount of chlorine added to the system each night should be increased so that the total residual each morning is about 1 mg Cl<sup>-</sup>/ℓ. The local health authorities should also provide users of household cistern water supplies with low-cost analytical services, at annual to biannual intervals, to analyze the cistern supplies for heavy metals and other contaminants of potential concern. Particular emphasis should be given to those contaminants included in the U.S. EPA National Interim Drinking Water Regulations (1976b).

5. Local health authorities should carefully evaluate the sanitary and chemical contaminant quality of all alternate water supplies which are used to supplement cistern supplies, especially private supplies to ensure that they meet U.S. EPA drinking water guidelines and regulations.

#### ACKNOWLEDGMENTS

Support for this investigation was primarily derived from G. Fred Lee & Associates-EnviroQual of Fort Collins, Colorado. Support was also provided by the Colorado State University Department of Civil Engineering, Fort Collins, Colorado. The chemical analyses were performed by C. Stratton and J. Lopez in the Department of Civil and Environmental Engineering Laboratories at the University of Wisconsin, Madison, Wisconsin. Their assistance in this study is greatly appreciated. The assistance of Pedrito Francois, Director of Environmental Health for St. Thomas, is also appreciated. Dr. I. Sanchez, on the staff of the Environmental Quality Board of Puerto Rico at the time of the study, provided information on the characteristics of the barged water supply. The authors are grateful for his assistance. Also, the assistance of the U.S. Geological Survey Caribbean District, San Juan, Puerto Rico for providing USGS data on groundwaters in St. Thomas, is appreciated. Professor Yu-Si Fok of the University of Hawaii at Manoa Water Resources Research Center should be recognized for organizing the International Cistern Water Supply Conference and for encouraging development of this paper.

#### REFERENCES

American Public Health Association, American Water Works Association, and Water Pollution Control Federation. 1971. Standard methods for the examination of water and waste water. 13th ed. Washington, D.C.: American Public Health Association.

Fishman, M.J., and Midgett, M.R. 1968. Extraction techniques for the determination of cobalt, nickel and lead in fresh water by atomic absorption. In Trace Inorganics in Water, ed. R.A. Baker, Advances in Chemistry Series 73, pp. 230-235. Washington, D.C.: American Chemical Society.

- Klein, R. 1971. "Brief initial report on field survey to St. Thomas, United States Virgin Islands, October 8-October 18, 1971." Preliminary report.
- \_\_\_\_\_. 1972. Final report on field survey to St. Thomas, United States Virgin Islands, October 8-October 18, 1971.
- League of Women Voters, St. Thomas, St. John. 1970. A study of our Virgin Island government-structure and function. April.
- Lee, G.F., and Jones, R.A. 1981. "Chlorophyll as a water supply water quality parameter." (Submitted for publication)
- \_\_\_\_\_; Jones, R.A.; and Rast, W. 1981. "Evaluation of nitrogen and phosphorus loads to water supply reservoirs." American Water Works Association Quality Control in Reservoirs Committee report. (Submitted to Am. Water Works Assoc. for publication)
- National Academy of Science and National Academy of Engineering. 1973. Water quality criteria—1972. A report by the Committee on Water Quality Criteria Environmental Studies Board for the U.S. Environmental Protection Agency. Washington, D.C.: U.S. Government Printing Office. 594 p.
- U.S. Environmental Protection Agency. 1974. Safe Drinking Water Act. PL 93-523, 42 U.S. Code 300 g-1.
- \_\_\_\_\_. 1975. Interim Primary Drinking Regulations. Federal Register Pt. 141, 40:59566-88, (40CFR 141).
- \_\_\_\_\_. 1976a. Quality criteria for water. EPA 400/9-76-023. Washington, D.C.: U.S. Government Printing Office.
- \_\_\_\_\_. 1980. Water quality criteria (toxic chemicals). Federal Register 45(231), November 28.
- U.S. Geological Survey. 1965. Test drilling and ground water supplies St. Thomas and St. John, U.S. Virgin Islands. Information Release VI-19, St. Thomas and St. John.

## EFFECT OF ACID RAIN UPON CISTERN WATER QUALITY

Thomas L. King, Research Assistant  
Dept. of Environmental Science and Engineering  
Rice University  
Houston, Texas 77001, USA

and

P.B. Bedient, Assoc. Professor  
Dept. of Environmental Science and Engineering  
Rice University  
Houston, Texas 77001, USA

## INTRODUCTION

As consumption of water increases, surface water supplies are unable to meet the current demands and the receding groundwater table reflects the pressure placed on groundwater reserves. One potential source of water is precipitation. The use of rainfall catchment-cistern systems is not a new concept, but can be an old approach to an emerging need. Cisterns superficially appear to be a simple means to obtain water; however, cisterns require capital expense for the construction of the system, system maintenance, and a means of assuring cistern water quality. Current and future use of cisterns requires an evaluation of precipitation quality in addition to water quality degradation in cisterns. This paper addresses the impact of acid rain on cistern water quality.

## CISTERN WATER QUALITY DEVELOPMENT

Cistern water quality assurance is a result of basic requirements: structural integrity of the cistern, a watertight top such that no surface water enters the cistern, an overflow and/or air vent with screens, a drainage line, overall precautions to exclude rodents, and pure water entering the system. The basic system utilizes elevated or subsurface cisterns constructed of a variety of materials. With planning and deliberate construction, all of the aforementioned criteria are generally obtainable except for the need for pure water entering the system.

Contaminant introduction was the primary water quality problem. Factors such as catchment construction material played a role. Wood or thatch have rough surfaces which are more likely to retain dust, which could act as a contaminant to be washed into the system (Wagner and Lanoix 1959). Use of more efficient surfaces such as sheet metal increased the efficiency of the system and helped control contaminants, but inadvertently collected pollutants which could be held in suspension or in solution. Filters comprised of sand underlaid by charcoal and gravel were introduced to control these contaminants. Due to the efficiency of these dual system filters in removing the more prevalent pollutants, water quality was determined by the nature and degree of maintenance of the catchment area, appurtenances such as the filter and conduits, and the cistern. The cistern water quality techniques such as sand and charcoal dual filters require modifications to compensate for precipitation phenomena such as acid rain and its associated pollutants.



## ACID RAIN CONCEPTS

Evaporation and transpiration essentially distill water and therefore result in pure water vapor. As the water vapor rises in the atmosphere and reaches an unstable temperature, condensation occurs on nucleation sites. The droplet then reaches equilibrium as the constituents of both the host nucleation site and the atmosphere migrate into the condensate.

The nucleation sites are, in general, particles suspended in the atmosphere whose major sources are ground surface dust or fly ash resulting from the combustion of fossil fuels. The dust originating from the ground surface is often alkaline in nature and releases cations such as  $\text{Ca}^{++}$ ,  $\text{Mg}^{++}$ ,  $\text{K}^+$ ,  $\text{Na}^+$ , and possibly bicarbonate. Fly ash from fossil fuel plants are quite complex in nature and are formed through a number of processes such as condensation, thermal coagulation, and sublimation. Upon combustion of the fossil fuels, especially coal, trace elements are concentrated on the finer particulates or released as vapors. The fine fly ash and, in particular, the vapors often escape control mechanisms. Trace elements such as arsenic, antimony, cadmium, chromium, lead, nickel, and zinc are reported to exhibit preferential concentration on the particulates (Kaakinen, Jordan, and West 1975 and Linton, Low, and Natusch 1976). These particulates often serve as the aforementioned condensation sites as the plumes cool and pollutants are dispersed in the atmosphere.

Atmospheric gases such as carbon dioxide dissolve in the droplet as carbonic acid, a weak acid. The dissociation constant for the weak acid is such that the pH of the droplets saturated with carbonic acid is 5.65. If present, other gases such as sulfur dioxide and nitrogen dioxide also dissolve into the droplet and form strong acids such as sulfuric acid and nitric acid which result in a pH well below 5.6. In nature, these gases occur as a result of volcanic activity or the existence of large extremely shallow saltwater bays. Because of the rare natural occurrence of the strong acids, unpolluted droplets seldom have a pH below 5.65.

However, precipitation measurement has reported pH values of less than 5.6 for several decades in both Europe and the United States. Reports of acid rain occurred in Scandinavia and England in the fifties and the United States in the early sixties. Since these initial reports, the frequency and distribution of acid rain occurrence has increased dramatically. Vermuelen (1979) observed that in the Netherlands the majority of acid rain results from sulfur dioxides which are present in the atmosphere as sulfuric acid in rain. The mechanism for the acid rain formation appears to be the sulfur dioxide adsorption by condensation nuclei and the scavenging by rain of other sulfur oxide particulates present in the atmosphere. The source of the particulates bearing the sulfur oxides are the combustion of fossil fuels (Vermuelen 1979). According to Vermuelen, sulfur oxide emissions for the Netherlands for 1946 were 200,000 tons per year. The sulfur dioxide concentrations rose progressively to 700,000 tons per year in 1960 and reached a maximum of 970,000 tons per year in 1968. Acid rain increased in both frequency and magnitude in a like manner. Since 1968, use of coal and oil as fuels has decreased due to a rise in natural gas utilization. As the natural gas supplies have diminished, future dependence upon oil and coal will again result in rising sulfur oxide emissions. Other countries in Europe exhibit similar sulfur oxide emission trends which have resulted in long range transport of the air pollutants from the sources. As a

result, a more general pattern of acid rain deposition occurs which affects downwind countries such as Scandinavia.

Acid rain trends have occurred in the United States in much the same manner as Europe. Although the detection of the phenomena was late in developing in the United States, reports indicated that the acid rains were discovered initially in the northeastern section of the U.S. Unlike Europe, the acid rain in the northeast originates from both sulfur oxides and nitrogen oxides. Cogbill and Likens (1979) report that the sulfuric acid comprises 60% and nitric acid 30% of the acid rain for the northeastern U.S. The major sources of the acid precursors are: fossil fuel combustion for the sulfur oxides, and a combination of the internal combustion engine and stationary combustion sources, respectively. Stationary sources of nitrogen oxide emission are boilers and fossil fuel plants. Spreading across the United States, acid rain has been reported in California since the early seventies. According to Liljestrand and Morgan (1978), the major constituent of California acid rain is nitric acid. Liljestrand and Morgan (1973) report that in California, emissions of nitrogen oxides are twice that of sulfur oxides on an annual basis. The analysis reveals that the stationary sources of oxides are expected to be more important than ground level emissions in the formation of the sulfuric and nitric acids. Acid rainfall is occurring in greater frequency in the west and southwest at this time. Preliminary studies by James et.al. (1976) indicate that acid rain is a local phenomena adjoining lignite plants in Texas. Data collected by the City of Houston Public Health Department indicate that acid rain with a pH range of 3.3 to 5.8 occurred in the Houston metropolitan area during 1979 and 1980 and that sulfur oxides and nitrogen oxides are prevalent. However, definitive work for regional acid rain effects is needed. The Houston acid rain sampling indicates that, in general, a diurnal and seasonal trend exists for the Houston metropolitan area. More detailed research is necessary to break down constituent contributions for the Houston area and southwestern region of the U.S.

Another characteristic of the air pollutant particulates which results in acid rain is their dry deposition. Similar to acid rain, dry deposition appears to vary both diurnally and seasonally (Hicks 1979). The dry deposition flux varies with respect to both the atmospheric and surface characteristics in addition to the particulate size and density. Upon deposition, the particulates will impart a localized dose of strong acid. The droplets which surround the particulate often exhibit concentrations resulting in a pH of 2.5 to 3.0. (Penkett, Jones, and Eggleton 1979). According to Hicks, dry deposition may vary two orders of magnitude less than acid rain, with respect to frequency and total mass.

#### IMPACT ON CISTERN WATER QUALITY

Acid rain will have a multiple impact on cistern water quality. First, the acid rain includes both the acid and mineral constituents of the droplet and the complex mineral constituents of the particulate matter. As discussed earlier, the acid rain may contain a combination of sulfuric acid, nitric acid, cations, anions, and bicarbonate, in addition to minor chemical species. The acids have the potential of leaching contaminants from the collection system, cistern components, or particulates carried in the rain. One aspect of the scrubbing process in the atmosphere results in the majority of the strongest

acid rain contaminants occurring early in the event. In general, the early precipitation will exhibit a lower pH and a higher particulate concentration.

Second, the initial phase of the rainfall will flush the catchment area of the majority of the dry deposition materials such as acid particles, dust, and organic material. Therefore, the initial rain may have a higher concentration of contaminants, and through the first flush effect increase the suspended solids concentration. Filter systems discussed earlier in the paper are inadequate for these types of contaminants. The sand and gravel layers will have a fairly high efficiency rate for collection of the larger natural particles. Man-made particulates which are smaller in diameter and lower in density exhibit hydraulic properties that result in a collection efficiency inverse to their individual sizes. In addition, the acid nature of the water will still leach many water contaminants from the particles trapped in the dual filter system. Charcoal layers help in removing many taste and odor problems, but will have decreased efficiency with the acidic water. Efficiency of the removal process by the charcoal will vary depending upon factors such as the chemical constituents and the pH of the rain water, the physical characteristics and depth of the charcoal layer, and the maintenance of the charcoal system. The efficiency of removal by the charcoal will be best for large contaminants such as organic compounds, but will decrease in efficiency for smaller ionic contaminants. Removal of the ionic species by the filter will require treatment by additional methods, e.g. resin columns and chemical treatment. A detailed analysis of the necessary treatment processes for acid rain contaminants to cistern water quality is outside of the scope of this discussion, but poses a major problem. The addition of a resin column after the dual action filter would be difficult due to the slow flow characteristics of these columns and the cost of purchase and operation. Chemical treatment of the contaminants due to acid rain and dry deposition requires more chemical purchases and an increase in maintenance requirements.

A simpler system of first flush control is the operation of a bypass gate or valve between the catchment collection system and the filter. Wasting of the initial surge of rainfall would eliminate the first flush of contaminants and acid rain. The volume of water wasted to eliminate the contaminants is a minor portion of the total catchment rainfall volume.

#### SUMMARY

Future use of cisterns in the southwest or other regions is dependent upon the water quality maintained in the cistern. One factor which will impact the water quality of cisterns is acid rain. As discussed, acid rain and associated contaminants from dry deposition are not readily controlled by the current cistern system design. To utilize precipitation, acid rain must be controlled through improved methods for maintenance of catchment systems, water treatment, and/or collection operation.

#### REFERENCES

Cogbill, C.V., and Likes, G.E. 1974. Acid precipitation in the northeastern United States. Water Resour. Res. 10:1133-1137.

- Fok, Y.S.; Murabayashi, E.T.; and Song, R.H.L. 1979. Rain water roof-catchment cistern system for residential water supply. In III World Congress on Water Resources Proceedings 4:1712-1717, International Water Resources Association, at Mexico City, Mexico, 23-27 April 1979.
- Galloway, J.N. 1979. Acid precipitation: Spatial and temporal trends. In Acid Rain, Proc. of Research Council on Environmental Impact Analysis of Technical Council Research, Am. Soc. Civ. Eng. National Convention, Boston, Massachusetts, 2-6 April, pp. 1-19.
- Gunnerson, C.G., and Willard, B.E., eds. 1980. Acid rain. Proc. of Research Council Research, Am. Soc. Civ. Eng. National Convention, Boston, Massachusetts, 2-6 April. vii + 166 p.
- Hicks, B.B. 1979. On the dry deposition of acid particles to natural surfaces. In Polluted Rain, ed. T.Y. Toribara and M.M. Miller, Rochester Int. Conf. on Environmental Toxicity, Environ. Sci. Res., vol. 17. New York: Plenum.
- James, W.P.; Slowey, J.F.; Garrett, B.L.; Ortiz, C.; and Ortiz, J. 1976. Potential impact of the development of lignite reserves on water resources of East Texas. OWRT B-199-TEX (1), PB-263 492/1GA.
- Liberti, A.; Bracco, D.; and Possanzini, M. 1978. Adsorption and oxidation of sulfur dioxide on particles. Atmos. Environ. 12:255-261.
- Likens, G.E. 1979. Acid rain. Sci. Am. 241:43-51.
- Liljestrand, H.M., and Morgan, J.L. 1978. Chemical composition of acid precipitation in Pasadena, California. Environ. Sci. Technol. 12:1271-1273.
- Kaakinen, J.W.; Jordan, R.M.; Lawasani, M.H.; and West, R.E. 1975. Trace element behavior in coal-fired plant. Environ. Sci. Technol. 862-869.
- Linton, R.W.; Loh, R.; and Natusch, D.E.S. 1976. Surface predominance of trace elements in airborne particles. Science 191:852-854.
- Penkett, S.A.; Jones, B.M.R.; and Eggleton, A.E.J. 1979. A study of SO<sub>2</sub> oxidation in stored rainwater samples. Atmos. Environ. 13:139-147.
- Stensland, G.J. 1979. Precipitation chemistry trends in the northeastern United States. In Polluted Rain. New York: Plenum.
- Vermuelen, A.J. 1979. The acid precipitation phenomenon. In Polluted Rain. New York: Plenum.
- Wagner, E.G., and Lanoix, J.N. 1959. Water supply for rural areas and small communities. World Health Organization.
- Wright, F.B. 1939. Rural water supply and sanitation. New York: John Wiley.

## OCCURRENCE OF SELECTED HEAVY METALS IN RURAL ROOF-CATCHMENT CISTERN SYSTEMS

William E. Sharpe, Assistant Professor  
Forest Resources Extension and  
Institute for Research on Land and Water Resources  
The Pennsylvania State University  
University Park, Pennsylvania 16802, USA

and

Edward S. Young, Research Assistant  
School of Forest Resources and  
Institute for Research on Land and Water Resources  
The Pennsylvania State University  
University Park, Pennsylvania 16802, USA

### INTRODUCTION

Roof-catchment cistern systems consist of a roof, usually the house roof, which serves as an impervious catchment for precipitation, and a cistern to store the collected water. The stored water is pumped from the cistern to points of use within the house. Very little is known about the prevalence of this type of water supply in the United States or the quality of drinking water obtained from such systems. A recent paper by Kincaid (1979) cites Ohio Department of Health records that reported a total of 67,000 cistern systems in the state of Ohio alone. A company owned and operated by Mr. Kincaid specializes in providing service to cistern owners in Ohio. The company handles approximately 800 requests for assistance each year and provides specialized water treatment equipment to its customers. Since most of this equipment is designed to remove particulates and disinfect cistern water, it may be concluded that these are important cistern water quality problems. However, the relatively new phenomenon of acid rain (Cogbill and Likens 1974) and the deposition of toxic metals such as lead (Lazrus et al. 1979; Hutchinson 1973) in roof-catchment cistern systems have not been previously investigated.

Roof-catchment cisterns are common in regions of the United States where groundwater supplies are either unavailable or unusable. Cisterns are present in the coal mining regions of Pennsylvania where groundwater has been polluted by mining and public water supplies are unavailable. Additional concentrations of these systems occur where groundwater has not been successfully developed and surface water sources are either polluted or nonexistent. The former case generally prevails in rural areas of Clarion and Indiana Counties, Pennsylvania and in much of southeastern Ohio.

Although each cistern system was unique, most cisterns were constructed of concrete or cinderblock coated with a waterproof cement-base sealant. Sixteen of the 40 systems evaluated in 1980 incorporated sand and gravel filters to remove particulates from incoming precipitation. In those systems with sand and gravel filters, CaCO<sub>3</sub> may have also been added as the precipitation passed through the filter.

A study was designed to survey water quality in roof-catchment cistern water systems to determine the occurrences of the toxic metals, lead, cadmium and copper. A related objective involved the evaluation of the corrosivity of the water being collected and stored in roof-catchment water systems and its relationship to plumbing type, cistern construction materials and water treatment devices.

#### STUDY AREA

The main study area was located in Clarion County and involved 35 roof-catchment cistern systems. An additional five systems were located in Indiana County. Both of these areas are rural in nature and thought to be receiving air pollutants from the heavily industrialized Ohio River Valley to the southwest (Cogbill and Likens 1974). Study participants were solicited through a press release published in local newspapers. All of the systems studied were in use and were sampled without interfering with normal operations.

A variety of water treatment methods were employed by the owners of the systems studied. In most cases this treatment consisted of roof runoff filtration by a sand and gravel filter, periodic disinfection and/or an in-line sediment or taste and odor cartridge filter. Few of the systems studied employed all three of these treatments and some had no water treatment at all.

#### METHODS

Cistern water supplies were sampled at all participating homes in 1979 and 1980. Each system was sampled twice in 1979 and three times in 1980. Thirty-two systems were sampled in 1979. Eight systems were added to the study in 1980, bringing the total sampled in that year to 40.

In 1979, samples were collected from a cold water tap within each house (usually the kitchen) and from each cistern at a point just below the surface of the stored water. The tap-water samples were taken at random times throughout the day. Samples were collected on 12-13 March and 30-31 July and analyzed for lead and cadmium only.

In 1980, samples were collected from three additional locations within each system and the tap-water sampling scheme was standardized. A sample was collected by each system owner from the kitchen cold water tap prior to any other water use that day. An additional tap-water sample was collected from this same tap at some time later in the day, after allowing the cold water faucet to remain full open for 30 seconds. Samples were also taken from the surface and 15 cm above the bottom of each cistern. Cistern sediment/water samples were also obtained from each system. These samples were a mixture of water and sediment removed from the bottom of the cistern by a vacuum pump. Metals concentrations for these samples were based on the volume of water and sediment collected; consequently, the concentrations of metals in sediment only are likely to be many times higher. Samples were collected on 26-28 March, 8-10 July and 12-14 August 1980 and analyzed for lead, cadmium, copper, calcium, pH, specific conductance and alkalinity. An estimate of total dissolved solids was obtained by multiplying the observed conductance by a factor of 0.55 (Hem 1970).

Langelier saturation index was computed for the July and August samples. The Langelier saturation index is an indication of the amount of instability of water with regard to calcium carbonate deposition and solution. A positive value indicates a tendency to deposit calcium carbonate. A negative value indicates a tendency to dissolve calcium carbonate.

Following collection, each metals sample was acidified with concentrated  $\text{HNO}_3$  to  $\text{pH} < 2.0$ . Next, a 25-ml aliquot of each sample was digested at  $95^\circ\text{C}$  for three hours. After digestion, distilled water was added to each sample until its volume was again 25 ml. Metals concentrations were determined with a Perkin-Elmer Model 703 atomic absorption spectrophotometer with a Model 2200 heated graphite atomizer. Metals concentrations so determined are reported as "total metals" concentrations (USEPA 1979). Where metals concentrations were less than detection limits, a value equal to one-half the detection limit was assigned and used to compute means.

## RESULTS AND DISCUSSION

**CISTERN WATER.** Cistern water was found to be very corrosive in most systems; however, the majority of the cisterns sampled showed a marked increase in pH, alkalinity, conductivity and calcium concentrations over levels found in locally collected bulk precipitation. These increases were far less dramatic in cisterns that were most effectively sealed. The four cisterns with vinyl liners and no gross particulate filters had a mean Langelier saturation index value for July 1980 of -6.8. The average Langelier saturation index value for cisterns without vinyl liners in July 1980 was -1.9. This finding supports the hypothesis that the corrosive roof runoff water was dissolving  $\text{CaCO}_3$  from the concrete cistern construction materials thereby decreasing its corrosivity. Although saturation index values for water stored in most cisterns tended to improve, in most cases they remained negative, indicating that potential corrosion problems still existed. It was further hypothesized that this increased  $\text{CaCO}_3$  saturation resulted in precipitation of dissolved lead from the stored water, and that particulate lead settled out of the cistern water during storage. To confirm this hypothesis a new sampling scheme was devised and implemented in 1980. A sampling apparatus was developed to allow sampling of the water and sediment with 1 cm of the bottom of the cistern.

The data presented in Table 1 summarize the metals results from the cistern sediment/water samples. Maximum concentrations for lead and cadmium greatly exceed mandatory drinking water limits (National Academy of Science 1977). Of even greater concern is the frequency of occurrence of these high concentrations. Lead concentrations in cistern sediment/water samples exceeded the drinking water limit in 55, 42 and 59% of the systems, respectively, for the three sampling dates in 1980. Sediment/water cadmium levels exceeded the drinking water limit in 15% of the homes studied.

Systems incorporating particulate filters had much lower sediment/water metals concentrations. The minimum and maximum sediment/water lead concentrations for systems without such filters were 5 and 2610  $\mu\text{g}/\text{l}$ , respectively. Systems with gross particulate filters had a minimum sediment/water lead concentration of 5  $\mu\text{g}/\text{l}$  and a maximum of 102  $\mu\text{g}/\text{l}$ . The mean sediment/water lead concentration for systems without filters was 348  $\mu\text{g}/\text{l}$ , whereas the mean for those with filters was only 32  $\mu\text{g}/\text{l}$ . Similar comparisons can be made for

TABLE 1. SUMMARY OF METALS DATA FOR CISTERN SEDIMENT/WATER SAMPLES COLLECTED IN 1980

1980 SAMPLING DATE	HEAVY METALS	CONCENTRATION			EXCEEDING DRINKING WATER LIMITS	
		Max.	Min.* ( $\mu\text{g}/\ell$ )	Mean	No.	%
26-28 March <sup>†</sup>	Cu	400	<50	77	0	0
	Cd	33	<1	3.1	4	11
	Pb	2610	<10	232	21	55
8-10 July <sup>‡</sup>	Cu	450	<30	106	0	0
	Cd	30	<1	2.4	1	3
	Pb	657	<5	102	15	42
12-14 August <sup>§</sup>	Cu	310	<30	61	0	0
	Cd	25	<1	3.2	3	9
	Pb	1430	<20	189	20	59

\*Detection limit values.

<sup>†</sup>Samples from 38 systems.

<sup>‡</sup>Samples from 36 systems.

<sup>§</sup>Samples from 34 systems.

cadmium and copper.

The metals analyses of the cistern water samples collected in 1979 revealed a maximum lead concentration of 26  $\mu\text{g}/\ell$ . Only two samples had lead concentrations over the detection limit and no cadmium concentrations exceeded detection limits. Maximum values for cadmium and copper were below drinking water limits for all cistern water samples collected in 1980. For most systems, cistern water cadmium was below the detection limit of 1  $\mu\text{g}/\ell$ . Copper was also relatively low in all of the cistern water samples. Lead maxima were over the drinking water limit for three cistern water samples collected in 1980.

TAP WATER QUALITY. Water samples were collected from a cold water tap within each of the 32 cistern systems in 1979. None of the systems investigated in 1979 produced samples in which cadmium exceeded the maximum contaminant level in water of 10  $\mu\text{g}/\ell$ . Of the 32 systems sampled, only 8 (25%) exhibited lead concentrations in excess of detection limits and 5 (15%) produced tap-water samples that exceeded the mandatory drinking water limit of 50 micrograms lead/liter on at least one occasion (Table 2).

Samples of tap water were collected from the study homes on three occasions during 1980. The samples were of water that had remained in household plumbing overnight (standing tap water) and running tap water. These samples were analyzed for lead, cadmium and copper. Lead and copper data for the standing tap-water samples are summarized in Table 3.

The data presented in Table 3 indicates that 9 of the 40 houses, or 22.5%,



TABLE 2. CONCENTRATIONS OF LEAD FOUND IN CISTERN AND TAP WATER IN 1979 IN HOMES WITH APPRECIABLE LEAD

HOUSE NO.	MARCH		JULY	
	Cistern	Tap	Cistern	Tap
	-----( $\mu\text{g}/\ell$ )-----		-----( $\mu\text{g}/\ell$ )-----	
1	ns*	77	ns	<20 <sup>†</sup>
2	26	23	20	52
3	<20	28	<20	26
4	<20	65	<20	64
5	<20	294	<20	92
6	20	<20	23	<20
7	<20	80	<20	25
8	<20	36	<20	<20
Mean	13.7	76.6	13.3	36.1
Min.	20	20	20	20
Max.	26	294	23	92

\*No sample.

<sup>†</sup>20  $\mu\text{g}/\ell$  was the detection limit.

TABLE 3. MEAN COPPER AND LEAD CONCENTRATIONS IN STANDING TAP-WATER SAMPLES

Home	Mean	Mean	Home	Mean	Mean
	Copper	Lead		Copper	Lead
	Conc.	Conc.		Conc.	Conc.
	-----( $\mu\text{g}/\ell$ )*-----			-----( $\mu\text{g}/\ell$ )*-----	
1	48	4	21	3607	14
2	50	4	22	45	8
3	1007	53	23	150	95
4 <sup>†</sup>	48	10	24	493	6
5	453	11	25	150	9
6	657	18	26	108	6
7	1007	15	27	50	6
8	60	34	28	1193	73
9 <sup>†</sup>	52	8	29	1200	15
10	1273	14	30	963	109
11 <sup>†</sup>	103	12	31	235	4
12	58	6	32	1877	10
13	1290	16	33	337	13
14 <sup>†</sup>	25	11	34	323	31
15	2270	72	35	107	12
16	3120	69	36	787	54
17	3113	80	37	333	14
18	493	6	38	500	9
19	2667	8	39	113	13
20 <sup>†</sup>	55	6	40	503	113

\*Computed from 3 samples collected at same location in each house during 1980.

<sup>†</sup>Houses with all-plastic plumbing.

had mean standing tap-water lead concentrations in excess of the maximum permitted by the U.S. drinking water standard. In addition, 12 of the 40 houses, or 30%, exhibited mean standing tap-water copper concentrations in excess of the recommended limit of 1000  $\mu\text{g}/\ell$  (1 mg/ $\ell$ ).

On the other hand, nearly all the running tap-water samples contained concentrations of lead and copper well below the drinking water limits. Mean lead concentrations ranged from a minimum of 4  $\mu\text{g}/\ell$  to a maximum of 34  $\mu\text{g}/\ell$  for running tap-water samples from individual homes. These means compare with 4 and 113  $\mu\text{g}/\ell$  for the standing tap-water samples. Mean copper concentrations ranged from a minimum of 25  $\mu\text{g}/\ell$  to a maximum of 513  $\mu\text{g}/\ell$  for running tap-water samples. These means compare with 25 and 3607  $\mu\text{g}/\ell$ , respectively, for the standing samples.

Five homes in the study were serviced by all-plastic plumbing, as indicated in Table 3. Lead concentrations of the standing tap-water samples from these five homes ranged from a mean of 6  $\mu\text{g}/\ell$  to 12  $\mu\text{g}/\ell$ . Standing tap-water copper concentrations for these five homes ranged from a mean of 25 to 103  $\mu\text{g}/\ell$ . A comparison of these concentrations to those for the remainder of the study homes indicates that homes with plastic plumbing had significantly lower concentrations of the corrosion products, lead and copper. The relative concentrations of lead and copper in tap-water samples from plastic plumbing vs. plumbing with lead-soldered copper components are indicative of the corrosiveness of the cistern water being conveyed through these systems.

Several hypotheses were formulated from these results: (1) concentrations of corrosive products appeared to be proportional to the length of time the cistern water was stored in the plumbing system, (2) concentrations of the corrosive products lead and copper also appeared to be greatly reduced in plumbing systems with primarily plastic components, (3) lower percentages of lead in tin/lead solder would result in lower lead concentrations in tap water (Wong and Berrang 1976).

**CORROSION TEST.** To test these hypotheses under controlled conditions, two corrosion test rigs, each consisting of three equal lengths of lead-soldered copper pipe and one all-plastic pipe, were fabricated. Each copper pipe was composed of four 1.5-m (5-ft) sections soldered at the joints and laid out in parallel 6.1-m (20-ft) lengths. Each 6.1 m length was attached to a central all-plastic manifold. A different tin/lead solder was used on each of the three copper pipes within a test rig. The formulations used included 50/50, 60/40 and 95/5 tin/lead solders (ratios indicate percent by weight of each metal in the solder). Results of the laboratory corrosion tests using cistern water from study system number 10 are summarized in Table 4. System number 10 was chosen because it was available for this phase of the study and because its cistern water exhibited a relatively high corrosiveness.

The data presented in Table 4 clearly show the advantage of PVC plastic pipe in reducing heavy metals concentrations in tap water. Lead-soldered copper test pipes produced sample water with lead concentrations over the U.S. drinking water limit in every case. Tin/lead solder formulation seemed to have little direct influence on the lead concentrations in the corrosion test samples. Copper concentrations in samples from copper test pipes also exceeded the recommended drinking water limit in all but one case. The residence time of cistern water in the test pipes strongly influenced metals con-

TABLE 4. RESULTS OF LABORATORY CORROSION TEST USING CISTERN WATER FROM SYSTEM NUMBER 10

TEST SAMPLE SOURCE	METALS CONCENTRATIONS			
	Cu		Pb	
	1 hr	10 hr	1 hr	10 hr
	----- (µg/ℓ) -----			
Feed water (LSI-4.8)	50	50	10	10
PVC plastic pipe	50	50	10	10
95/5 copper pipe	1250	3450	142	221
60/40 copper pipe	1030	3000	118	224
50/50 copper pipe	910	3140	84	207

centrations. Pipe-water lead concentrations increased by an average of 90% and copper concentrations by an average of 201% when residence time was increased from one to ten hours. Cadmium concentrations were less than 1 µg/ℓ for the feed water all test samples.

The 1-hr test results are of importance in the management of rain water cistern systems for the control of metals concentrations in tap water. The results indicate that unacceptable concentrations of metals in tap water are possible within an hour or less after corrosive water is introduced into a lead-soldered copper plumbing system. This means that cistern water drawn from such a plumbing system at any time during the day is likely to be contaminated. There is some evidence in the literature that "new" copper plumbing will yield higher absolute concentrations of corrosive products (Wong and Berrang 1976). The concentrations presented may be higher than those that would be obtained from plumbing that has been in service for a longer period of time. However, to reduce this problem the test rigs used were flushed with 3800 ℓ of aggressive water (LSI of -4.0) before the tests were conducted.

#### SUMMARY AND CONCLUSIONS

The concentrations of lead, cadmium and copper in cistern water were relatively low and nearly always below drinking water limits. The cistern water in most systems acquired calcium carbonate (CaCO<sub>3</sub>) by virtue of its contact with this material in the walls of the cistern. This resulted in removal of soluble metals by the precipitation process. However, gravitational settling of particulates and associated metals during cistern storage probably accounted for most of the reduction in lead concentration. Cisterns with vinyl liners had the most corrosive water. Seven percent of the systems sampled in 1980 had cistern water in excess of the drinking water limit for lead.

Much of the lead and cadmium that entered the systems in collected precipitation appeared to have accumulated in the sediment on the bottom of the cisterns. Cistern sediment/water lead concentrations exceeded the drinking water limit in 70% of the systems studied on at least one occasion. Cadmium concentrations in cistern sediment/water samples exceeded the drinking water limit in 15% of the systems on one or more occasions. Roof-catchment cistern systems with gross particulate filters for roof runoff had much lower mean

lead concentrations in the sediment/water layer at the bottom of the cistern than those that did not. Twenty-five percent of the filtered systems contained sediment/water lead over the drinking water limit, as compared to 71% for unfiltered systems in the March 1980 sampling run.

Analysis of random tap-water samples in 1979 revealed lead concentrations in excess of the 50 µg/l drinking water limit for 13% of the homes studied. Standing tap-water samples collected in 1980 had lead concentrations over the drinking water limit in 22.5% of the systems. Homes with all-plastic plumbing had much lower metals concentrations in standing tap water.

A controlled corrosion test using cistern water showed that lead and copper concentrations were greatest in lead-soldered copper pipes irrespective of tin/lead solder formulation and least in plastic pipe. Concentrations of lead and copper in pipe water were also greater after ten hours of exposure than after one hour. Lead and copper concentrations exceeded drinking water limits in all tests with the exception of those where plastic pipe was used.

There were no safeguards in any of the systems studied to prevent lead- and cadmium-contaminated cistern water and sediments from being ingested by system users; consequently, the accumulation and corrosion of these toxic metals in such systems poses a serious health threat.

#### REFERENCES

- Cogbill, C.V., and Likens, G.E. 1974. Acid precipitation in the northeastern U.S. Water Resour. Res. 10(6):1133-37.
- Hem, J.D. 1970. Study and interpretation of the chemical characteristics of natural water. 2nd ed., U.S.G.S. Water Supply Paper 1473. 99 p.
- Hutchinson, T.C. 1973. Lead pollution, the automobile and health. Publ. EF-5, Institute of Environmental Sciences and Engineering, Univ. of Toronto, pp. 1-10.
- Kincaid, T.C. 1979. Alternative individual water sources. In Quality Water for Home and Farm: Proc. Third Domestic Water Quality Symposium, Am. Soc. Agric. Eng., pp. 73-78.
- Lazrus, A.L.; L'Orange, E.; and Lodge, J.P., Jr. 1970. Lead and other metal ions in U.S. precipitation. Environ. Sci. Tech. 4(1):55-58.
- National Academy of Sciences. 1977. Drinking water and health. Vol. 1, Washington, D.C..
- U.S. Environmental Protection Agency. 1979. Methods for chemical analysis of water and wastes. EPA-600/4-79-020.
- Wong, C.S., and Berrang, P. 1976. Contamination of tap water by lead pipe and solder. Bull. Environ. Contam. Toxicol. 15(5):530-534.

## A WATER QUALITY ARGUMENT FOR RAINWATER CATCHMENT DEVELOPMENT IN BELAU

Charles Romeo, Graduate Student  
Biology Department  
University of Guam  
Mangilao, Guam 96913, USA

### INTRODUCTION

**SUMMARY OF PROBLEM.** The quantity and quality of fresh water for human use has been a critical area of development in the Republic of Belau, formerly Palau, in the Western Caroline Islands. In an area which receives about 3 810 mm (150 in.) of rainfall per year, development of water resources has lagged behind demand and use. The primary emphasis for the last thirty years has been on the development of a centralized water system utilizing the impoundment of surface water. Resulting water hours from an insufficient quantity of water and delivery problems plus poor quality have limited the effectiveness of the municipal system in meeting the needs of the consumer. Because of these quantity and quality problems, rain water has been extensively utilized for human consumption. Yet, there has been little organized effort to develop this resource beyond a rudimentary level. Thus, rainwater catchments are often inadequate during certain times of the year.

With increased growth and development and a need to be self-sufficient, a sound water resources development policy that includes rainwater catchment should be considered for the Republic of Belau. The high quality of rain water in this geographic area should be an important factor in this choice.

**SETTING.** The Republic of Belau (Palau) is an archipelago in the Western Caroline Islands which marks the westernmost boundary of Micronesia. The main island group is located around 134°30' east longitude and 7°20' north latitude (Fig. 1) and consists of atoll, volcanic, and pinnacled limestone islands of approximately 486.9 km<sup>2</sup> (188 miles<sup>2</sup>) of land mass (U.S. Army 1956). Babeldaob (Babelthuap), the largest island, is entirely volcanic and is the site of a major airport and the Airai reservoir, which is the municipal water source located at the southern end of the island. The islands of Koror, Ngarakabesan (Arakabesan), and Malakal lie adjacent to southern Babeldaob and are the center of governmental and commercial enterprises. An estimated 64% or 8064 of Belau's population live in the Koror area (PCAA 1981) for which the population density was calculated at 2000 persons per square mile (Warner, Marsh, and Karolle 1979). The islands to the south of Koror, Malakal, and Ngarakabesan are limestone in nature.

The Airai reservoir and the municipal water system were designed to serve the southern tip of Babeldaob and the population centers of Koror, Ngarakabesan, and Malakal. This paper will focus on these areas.

**CLIMATE.** Belau is a group of tropical islands characterized by wet and dry seasons; however, the seasons are not as pronounced as in other parts of the tropics. The months of June through November are the wetter months, and the months of February through May are the drier months of the year. Rainfall

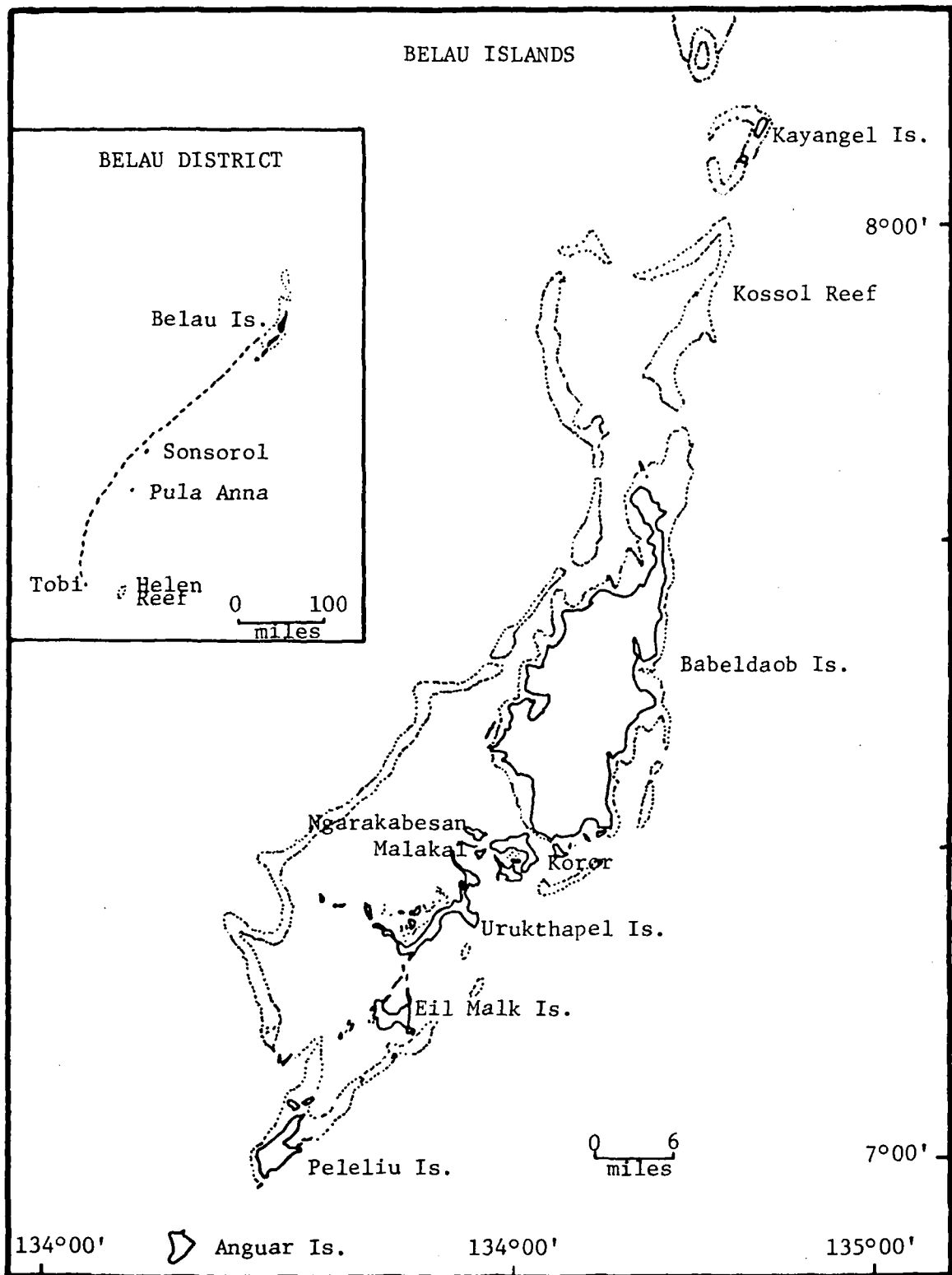

Figure 1. The Belau Islands.

TABLE 1. RAINFALL DATA, WESTERN CAROLINE ISLANDS, 1924-1941

RAINFALL, KOROR, 1924-1941 (in.)														Days >	
Year	Jan.	Feb.	Mar.	Apr.	May	June	July	Aug.	Sept.	Oct.	Nov.	Dec.	Annual	.004	.04
1924	6.06	5.16	5.71	10.00	18.62	13.35	23.27	7.91	13.38	16.10	18.78	14.92	153.26	303	244
1925	13.54	7.75	9.57	3.70	17.48	15.24	18.66	11.58	9.17	16.69	7.72	7.80	138.90	---	---
1926	21.73	4.09	3.98	3.78	9.76	12.44	16.77	23.70	16.54	13.35	12.32	11.58	150.04	289	237
1927	15.39	5.71	8.31	11.12	25.94	13.50	32.80	17.24	11.50	16.54	4.61	11.73	174.39	282	241
1928	10.91	16.46	7.60	6.48	14.49	15.63	24.29	18.03	12.12	8.94	5.20	19.57	159.73	282	233
1929	26.65	10.28	5.51	12.60	17.36	9.65	28.98	13.82	14.80	20.39	10.59	17.52	188.15	285	242
1930	8.19	17.13	6.06	6.14	12.48	9.80	17.20	5.58	20.75	6.54	7.80	15.04	140.93	264	206
1931	8.86	7.24	3.90	5.18	9.80	10.20	12.44	17.52	13.03	28.74	10.75	9.61	137.27	287	236
1932	31.38	13.35	10.12	6.77	18.27	9.45	14.41	11.42	21.10	9.37	23.78	13.98	183.40	289	234
1933	10.83	4.21	7.13	3.54	15.24	14.53	18.31	9.61	18.45	18.27	10.67	6.93	137.72	277	210
1934	15.28	11.06	9.69	12.91	9.25	14.17	10.71	17.91	23.45	7.72	16.06	11.46	159.67	298	255
1935	24.88	7.36	9.17	11.54	9.21	9.06	21.14	9.84	12.40	10.79	6.10	3.62	135.11	290	234
1936	8.42	24.49	4.49	22.65	17.73	16.41	29.76	30.03	6.05	11.00	4.63	7.01	160.63	---	---
1937	6.39	4.56	3.24	11.37	8.38	15.16	18.42	18.24	10.15	18.68	27.86	8.40	150.85	280	226
1938	7.18	3.46	8.94	19.47	15.90	6.46	7.26	7.04	12.55	13.35	15.48	12.71	129.80	269	225
1939	7.77	15.96	9.37	9.12	12.39	13.66	8.95	14.06	23.54	10.45	18.87	12.97	157.11	273	237
1940	15.60	11.28	6.15	5.72	12.28	14.11	18.78	19.72	7.82	12.83	8.28	7.71	140.28	263	207
1941	7.67	6.70	7.19	1.81	13.44	12.60	16.31	11.82	10.74	7.63	11.15	9.17	116.23	258	196

MEAN TOTAL PRECIPITATION (in.)

Station (S to N)	Jan.	Feb.	Mar.	Apr.	May	June	July	Aug.	Sept.	Oct.	Nov.	Dec.	Annual	Years of Rec.
Angaur.....	12.1	7.3	6.5	8.1	13.7	12.2	15.6	10.5	10.9	11.2	8.5	10.4	126.9	11-12
Peleliu.....	15.1	5.4	6.2	7.7	15.2	11.2	15.5	15.8	15.5	10.7	11.9	11.2	141.4	3
Koror.....	13.0	8.1	7.2	8.2	13.5	12.3	19.7	14.4	13.6	12.4	12.1	13.4	147.8	21
Melekeiok....	13.2	7.7	6.0	6.6	12.0	11.9	18.0	14.3	14.0	13.7	11.8	12.8	142.1	10-11
Ngermetengel.	14.1	8.9	7.6	7.4	15.3	14.9	20.6	14.9	17.5	17.4	13.5	15.6	167.7	10-11
Galap.....	15.5	8.9	6.3	7.4	14.0	13.7	16.6	13.8	14.0	13.1	11.2	14.0	148.5	10-11

TABLE 1—Continued

MEAN TOTAL PRECIPITATION (in.)  
(1-2 Days)

Station (S to N)	Jan.	Feb.	Mar.	Apr.	May	June	July	Aug.	Sept.	Oct.	Nov.	Dec.	Annual	Yrs. of Rec.
Angaur.....	3.0	3.3	3.2	4.1	3.0	1.8	1.6	2.6	2.8	2.7	3.6	3.2	34.9	9
Koror.....	3.3	3.5	4.5	3.9	2.6	3.8	2.8	3.3	3.3	3.8	4.1	3.8	42.7	13
Ngermetengel..	3.8	4.2	3.2	3.5	4.4	2.8	3.5	3.5	3.0	3.5	3.5	2.2	41.1	5
Galap.....	3.2	3.8	4.2	3.7	3.1	3.7	3.1	2.9	3.7	4.8	4.1	2.3	42.6	9

## (3-6 Days)

Angaur.....	0.6	1.1	1.1	0.6	0.4	0.3	0.1	0.6	0.4	0.8	0.3	0.3	6.6	9
Koror.....	0.5	1.0	0.8	1.1	0.9	0.1	0.5	0.6	0.5	0.5	0.2	0.3	7.0	13
Ngermetengel..	0.4	1.8	1.8	1.2	0.8	0.8	0.7	1.5	1.3	0.7	1.5	0.8	13.3	5
Galap.....	0.8	1.3	1.4	1.2	0.8	0.4	0.4	1.1	0.3	0.4	0.7	0.3	9.3	9

## (7 or More Days)

Angaur.....	0.0	0.0	0.0	0.1	0.0	0.0	0.2	0.0	0.0	0.1	0.0	0.0	0.4	9
Koror.....	0.0	0.0	0.0	0.1	0.0	0.0	0.0	0.1	0.1	0.1	0.0	0.0	0.4	13
Ngermetengel..	0.2	0.0	0.2	0.8	0.0	0.0	0.0	0.2	0.3	0.2	0.0	0.0	1.9	5
Galap.....	0.0	0.0	0.1	0.2	0.1	0.0	0.1	0.0	0.0	0.0	0.0	0.0	0.6	9



TABLE 1—Continued

MEAN NUMBER OF DAYS WITH RAIN (0.004 in. or more)														Yrs. of Rec.
Station (S to N)	Jan.	Feb.	Mar.	Apr.	May	June	July	Aug.	Sept.	Oct.	Nov.	Dec.	Annual	
Angaur.....	25.9	19.6	22.0	21.8	25.8	26.6	28.0	24.9	24.2	23.6	24.4	24.9	291.7	8-9
Peleliu.....	21.0	14.0	15.3	19.3	21.3	21.3	25.3	21.3	22.0	18.7	17.0	20.3	237.0	3
Koror.....	25.1	20.0	21.5	19.8	25.6	25.1	26.2	23.9	23.6	23.2	23.7	25.2	282.9	13
Melekeiok....	23.0	16.3	20.0	18.1	24.8	25.1	24.5	20.5	22.7	21.6	21.6	24.3	262.4	5-8
Ngermetengel.	24.5	18.0	17.0	13.7	21.4	23.8	24.5	20.7	23.3	20.7	19.7	25.2	252.5	3-6
Galap.....	24.5	18.1	20.2	18.1	23.6	23.1	24.1	21.5	22.8	22.9	22.5	26.5	268.0	8
(0.04 in. or more)														
Angaur.....	17.0	13.5	17.0	16.8	18.0	21.0	24.3	20.3	23.7	22.0	18.3	19.0	230.9	3-4
Peleliu.....	19.0	12.3	13.7	15.7	19.3	20.0	22.7	20.7	20.7	17.7	16.0	19.0	216.7	3
Koror.....	20.2	16.1	16.7	15.1	20.9	20.0	22.6	18.5	19.2	20.1	19.8	21.1	230.3	13
Melekeiok....	19.5	10.0	18.0	14.0	20.0	18.7	20.5	15.0	17.6	18.3	19.7	20.7	212.0	3
Galap.....	22.0	12.3	16.7	14.3	21.0	19.7	22.0	21.3	22.3	23.0	21.3	23.0	238.9	3
(1.0 in. or more)														
Koror.....	3.8	2.5	1.7	2.7	5.3	4.6	6.9	4.3	5.5	4.4	2.9	3.3	47.9	13

SOURCE: The Rainfall of Japan, Central Meteorological Observatory, Tokyo, Japan.

STATION: Meteorological Observatory of the South Sea Government at Koror,  
lat. 7°20' N, long. 134°42' E.

NOTE: All measurements converted from millimeters to inches.

data for the years 1924-1941, when Belau was under the Japanese mandate, are included in Table 1 and data from the U.S. National Weather Service station in Koror for the years 1947-1980 are presented in Table 2. As can be seen from the data, the driest months on the average receive 177.8 to 203.2 mm (7-8 in.) of rainfall (in Koror). The least monthly precipitation recorded as 31.5 mm (1.24 in.) in February 1973. The yearly rainfall is around 3810 mm (150 in.).

TABLE 2. RAINFALL DATA, KOROR, BELAU, 1947-1980

Year	Jan.	Feb.	Mar.	Apr.	May	June	July	Aug.	Sept.	Oct.	Nov.	Dec.	Annual
1947	----	----	----	----	-----	-----	14.00	15.42	7.88	-----	----	-----	-----
1948	8.61	7.15	5.25	1.65	21.05	18.98	16.10	16.53	9.83	14.99	9.02	18.89	148.05
1949	9.49	11.35	10.35	----	22.28	9.59	15.48	11.15	18.93	12.85	8.76	13.26	-----
1950	6.05	6.31	17.41	16.94	9.54	12.55	10.85	16.67	13.92	10.24	15.47	11.42	147.37
1951*	11.19	6.58	5.26	-----	-----	-----	9.51	12.51	8.58	6.77	10.74	13.98	-----
1952*	6.14	6.66	10.37	15.38	16.66	12.49	17.72	24.66	14.92	14.21	9.51	13.55	162.27
1953	10.86	4.07	14.66	5.23	13.99	19.17	18.68	16.97	15.18	9.75	13.19	17.45	159.20
1954	4.94	3.04	9.74	7.51	27.46	15.57	15.64	13.48	14.64	12.15	11.25	12.30	147.72
1955	19.39	15.14	2.46	6.47	13.29	17.81	8.68	8.92	10.87	14.27	8.58	7.51	133.39
1956	24.45	5.50	8.80	15.63	22.78	15.71	12.84	18.95	14.00	11.98	12.88	15.63	179.15
1957	4.74	2.42	6.72	16.42	9.68	12.60	16.69	21.57	16.12	19.22	4.70	7.62	138.50
1958	8.42	2.69	2.93	8.09	17.18	9.73	15.74	20.27	18.11	9.95	22.06	12.62	147.79
1959	6.28	3.49	10.82	12.96	13.09	12.26	22.53	14.88	13.12	16.64	15.41	10.41	151.89
1960	15.16	10.20	3.75	11.66	11.45	14.16	13.41	11.36	20.79	15.04	10.12	14.11	151.21
1961	15.79	10.13	6.25	6.72	20.14	22.67	13.68	17.37	11.61	18.55	7.81	13.23	163.95
1962	16.78	9.38	7.65	6.84	18.30	8.59	34.82	19.45	20.79	9.09	6.84	14.04	172.57
1963	18.63	8.79	8.41	3.39	12.01	13.99	11.19	14.24	14.01	10.23	6.73	13.40	135.02
1964	7.27	16.10	6.98	7.46	18.32	12.12	4.14	15.73	7.06	10.19	13.75	11.45	130.57
1965	6.40	13.03	14.60	7.11	9.78	19.85	30.57	16.76	12.98	9.68	6.16	12.67	159.59
1966	8.23	3.31	10.02	15.27	9.08	10.44	23.68	9.69	7.20	16.66	11.76	14.93	140.27
1967	18.86	3.74	7.20	4.63	9.91	17.19	12.20	17.11	6.75	17.06	11.79	12.23	138.67
1968	8.02	15.54	8.59	7.56	9.51	7.01	16.43	11.00	12.25	11.46	8.15	15.95	131.47
1969	6.14	2.93	5.11	6.83	11.72	16.79	28.21	12.39	14.00	9.81	9.06	6.32	129.31
1970	6.23	5.78	4.83	3.21	6.25	12.38	12.61	15.77	8.51	12.99	9.17	14.82	114.55
1971	13.54	10.68	11.09	8.32	16.31	19.61	14.49	10.40	13.98	19.59	10.26	11.06	159.33
1972	10.78	10.83	20.98	7.08	9.49	20.68	11.15	15.88	14.90	9.85	9.96	7.54	150.12
1973	2.11	1.24	2.95	11.29	10.16	13.78	12.79	11.35	12.18	19.14	16.56	9.87	123.42
1974	28.13	7.98	13.75	10.86	8.10	9.72	21.16	13.75	14.80	22.47	15.73	18.54	184.99
1975	17.29	2.82	6.69	10.00	9.01	16.24	22.86	8.28	17.24	11.52	11.18	21.10	154.23
1976	7.80	7.27	8.05	20.09	8.66	5.91	8.08	16.64	7.72	12.49	6.30	16.54	125.55
1977	5.18	5.30	3.60	4.48	11.36	11.15	20.72	19.20	12.65	10.63	7.38	7.79	119.44
1978	10.34	22.46	6.02	8.98	12.52	16.04	9.13	20.36	10.85	20.06	17.66	10.33	164.75
1979	6.98	6.47	7.96	27.69	11.26	22.84	17.79	11.69	12.29	11.97	11.57	11.57	160.08
1980	8.72	16.01	5.53	18.80	10.02	19.50	12.40	15.26	13.60	17.11	12.17	19.95	169.07
RECORD MEAN†	10.91	7.95	8.39	10.15	13.23	14.76	16.35	15.37	13.12	13.84	11.04	13.06	148.17

SOURCE: U.S. National Weather Service.

\*Indicates a station move or relocation of instruments.

†Partial years' data for 1974, 1949 and 1951 were not used in computing precipitation means.

## SURVEY AND SAMPLING

During June 1981, a survey of springs, seeps, wells, small reservoirs, and rainwater catchments was made in Koror State, Republic of Belau. This project was undertaken by the Water and Energy Research Institute of the Western Pacific as a public service to Belau, after an extended dry period of several months duration during which the Airai reservoir ran dry. The primary focus was on groundwater, but rain water was included because of its importance in

Koror water use patterns. Local people were interested and concerned about the quality of the rain water, which is the main source of drinking water (O'Meara 1981).

Samples were collected in sterile containers and transported on ice to the Sanitation Lab at the McDonald Hospital in Koror. Total coliform, turbidity, and conductance measurements were performed according to procedures in Standard Methods (APHA, AWWA, and WPCF 1975). These tests were chosen because of their relevance to the particular water quality needs in Belau (Cowan 1980) and the ease with which they could be performed in the Sanitation Lab.

## RESULTS AND DISCUSSION

There is little or no literature available on the development of water resources in Belau during the Japanese mandate. However, from observations of numerous remnants of water-related structures, it is obvious that the Japanese were keenly aware of and actively developed the many different water sources available, including catchments, shallow wells, small reservoirs, and a centralized water system. Many of the concrete catchment tanks are still in use, with the larger ones having a capacity of over 56.8 m<sup>3</sup> (15,000 gal).

It was also during the Japanese mandate that the current reservoir in Airai was constructed. The quantity and quality of surface water available from the reservoir have been serious problems for quite some time. Most of the population served by the municipal system receive normally only four hours of water service each day. Furthermore, the turbidity of the water is rarely less than 5 NTU and often between 10 and 20 NTU after heavy rains. The latosols which comprise most of Babeldaob soils are intensely weathered and leached, and the soil particles are almost entirely colloidal in size with no sand and little silt (U.S. Army 1956). Therefore, high turbidity of these surface waters has been a chronic problem.

Current plans for capital improvements of the municipal water system (at a cost of over \$3.5 million, U.S.) include pretreatment (flocculation and sedimentation) as the only means to reduce turbidity levels to meet the required standards (Hawaii Architects 1978, 1979). It is unlikely, however, the pretreatment will be feasible and may not be attempted. The operation and maintenance of such a plant and the logistic problems of keeping it supplied with the necessary chemicals are completely beyond the scope of present capabilities. Within several years, with the completion of the capital improvements for water supply and delivery, there may be a sufficient quantity of piped water, but the quality might be much the same.

High turbidity also lowers the effectiveness of chlorine in the treatment of water. Although increased amounts of chlorine are often used to treat the water in Belau, coliform bacteria are regularly found in the water.

In Belau, the potential for providing high quality water in sufficient quantity can be achieved by rain water catchment. The data in Table 3 provides a limited sample from a variety of catchment systems. Systems vary from open 208-l (55-gal) drums to large 56.8 m<sup>3</sup> (15,000 gal) concrete tanks. All of the zero coliform samples (except for No. 25) are from large enclosed 56.8 m<sup>3</sup> concrete tanks that were probably built during the Japanese mandate.

TABLE 3. RAINWATER CATCHMENT SAMPLES, KOROR, BELAU, JUNE 1981

I.D. No.	Total Coliform -----(/100 ml)-----	Fecal Coliform -----	Turbidity (NTU)	Specific Conductivity ( $\mu$ mhos)
19	0	-	0.9	58
29	0	0	1.7	47
40	0	-	1.4	50
41	0	-	1.1	45
64	0	-	1.1	18
25	0	0	4.0	6.3
55*	13	-	2.6	13
66*	140	-	1.5	14
67	8	-	4.5	22
58	10	0	6.4	65
60	70	-	0.9	7.7
94	100	6	3.1	12.5
91	140	-	2.6	170
57	510	2	3.6	90
96	530	32	1.8	6
53	590	--	2.5	43
80	3900	--	5.5	80

\*Same source as No. 25, but sampled at different times after heavy rain.

In general, the catchment water is of good quality with low turbidity. Many of the samples have a turbidity of less than 2.0 NTU and only two samples had a turbidity of over 5.0 NTU. The repeat samples of I.D. No. 25 were after heavy rains in excess of 381 mm (15 in.) in one week. The reason for the increase in coliform remains to be answered, however, in this particular area, rodents were seen on the catchment surface.

Water quality, however, is quite variable, which probably reflects the differences in design and maintenance of the systems. This is important because it reflects the fact that catchment water is only as good as the design, operation, and maintenance permit. The individual owner becomes responsible for the quality of his water and this undoubtedly is a factor in the convenience (or inconvenience) of this source.

None of the domestic rainwater catchment systems samples utilized water treatment in the system. One method that has been made known to the public and endorsed by the Sanitation Lab for water that is suspected of being contaminated is the addition of Chlorox bleach to the water. The amount to be added is determined by multiplying the volume of the catchment tank in gallons

by 90% and adding that number in tablespoons of bleach to the water. The water is mixed and allowed to stand for thirty minutes before consumption.

#### CONCLUSION

The water quality problems in Belau have not been adequately addressed in terms of the feasibility of alternative solutions. High turbidity has been a chronic problem in the municipal system and pretreatment of the water will be a technically difficult solution. Rainwater catchment systems may provide a readily available solution to this problem. Improvements in system design and proper maintenance could further improve the water quality—which currently can be quite variable—in catchments. Water quality, therefore, provides a strong argument for the development of rainwater catchment systems in Belau.

However, if rainwater catchment systems are to become a viable alternative source of water resource development in Belau, an obstacle that will have to be overcome is inconvenience. Local people want a modern, up-to-date system with the convenience of turning a tap to receive water. Therefore, catchment system design must incorporate some forms of sophistication without sacrificing simplicity if rainwater catchments are to compete favorably with other water sources.

#### REFERENCES

- American Public Health Association, American Water Works Association, and Water Pollution Control Federation. 1975. Standard methods for the examination of water and wastewater. 14th ed. Washington, D.C.: American Public Health Association. xxxix + 1193 p.
- Cowan, P. 1980. Future water quality monitoring priorities for the Trust Territory of the Pacific Islands. Tech. Rep. No. 16, Water Resources Research Center, University of Guam. vi + 61 p.
- Hawaii Architects and Engineers, Inc. 1979. Palau Water Treatment Plant Evaluation. Honolulu, Hawaii.
- \_\_\_\_\_. 1978. Water Treatment and Development Presentation Report for the Koror Municipality Water System Palau District Trust Territory of the Pacific Islands. Honolulu, Hawaii.
- O'Meara, C. 1981. An investigation of social aspects of fresh water use in selected hamlets of Belau. Micronesian Area Research Center, University of Guam. (In press)
- Palau Community Action Agency (PCAA). 1981. "Program Planning Committee Meeting". Koror, Belau, January 7.
- U.S. Army, Chief of Engineers. 1956. Military geology of Palau Islands, Caroline Islands. Intelligence Division, Headquarters, U.S. Army Pacific.
- Warner, D.C.; Marsh, J.A.; and Karolle, B.G. 1979. The Potential for Tourism and Report Development in Palau: A Socio-economic-ecological Impact Study. University of Guam.

RAIN WATER CISTERN UTILIZATION IN SELECTED HAMLETS  
OF THE REPUBLIC OF BELAU, WESTERN CAROLINE ISLANDS

Christine O'Meara, Graduate Student  
Department of Anthropology  
University of Hawaii  
Honolulu, Hawaii 96822, USA

INTRODUCTION

An examination of water procurement through the use of rain water cisterns should include not only rainfall data and the mechanical and the technical aspects of catchment systems, such as their design or operation, but equally important is the utilization of this water resource. The true test of the effectiveness of a rain water cistern system rests with those persons who will utilize the contained water supply. Fresh water usage is the result of deliberate human action and it is not surprising to find that particular types of water, depending upon its source, its quality, its quantity or availability, and its accessibility, have specific uses.

The following report summarizes the more salient points regarding rain water catchment utilization based on a recent investigation of fresh water usage in the Republic of Belau, formerly Palau. Entitled "An Investigation of Social Aspects of Fresh Water Use in Selected Hamlets of Belau" (O'Meara, in press) and conducted by the author, that study serves as the basis of this report. While the aim of the previous study was (1) the identification and mapping of traditional, historical, and modern freshwater sites and (2) the broader examination of freshwater utilization, the information presented here concerns rain water cistern systems and includes a description of historical and modern catchment systems, their utilization, and their water quality.

LITERATURE REVIEW

Literature related to the use of fresh water on Belau is quite limited. Included in a geological survey of these islands following World War II were several references made of freshwater supplies throughout the Palau archipelago (U.S. Army 1956). In the survey, descriptions of water resources concentrated on groundwater supplies, such as rivers, streams, seepage springs and the like. Although special attention was given to the rainfall data which the Japanese had compiled, its use as a water resource went unmentioned.

In the dissertation "Resource Exploitation and the Tenure of Land and Sea in Palau" (McCutcheon 1981), some data on freshwater use and the acquisition of rain water for household supplies was presented. This report briefly mentioned the use of rain water catchments in Melekeok, a village on Babeldaob Island to the north of the study area of Koror State. This description was congruent with the present report. Of the few sources dealing with freshwater resources, this is the only one to date that incorporates information concerning household water use practices.

Two architectural firms, Hawaii Architects and Engineers, Inc. (1978, 1980) and Austin, Smith and Associates (1974) have played a prominent role in studies of freshwater acquisition, distribution, and waste water systems in Belau; however, these studies focused upon capital improvements and infrastructure and paid little attention to the system of rain water cisterns. Ehrlich's recent paper "Oreor: A Center of Power, Commerces, and Colonial Administration" (in press) presents a comprehensive examination of historical sites and their distribution throughout Koror and neighboring islands. Included in these descriptions are references to rain water cisterns developed during the Japanese administration of these Micronesian Islands (1914-1944).

The Water and Energy Research Institute, formerly Water Resources Research Center, at the University of Guam compiled reports regarding fresh water uses and customs in the Marianas Islands some 1,000 miles northeast of Belau. Although historical in emphasis, the Guam (1979) and the Rota (1980) studies presented information relative to the utilization of rain water resources which corresponds to the use of this water supply in Belau.

#### METHODOLOGY

Structured interviews and observational field techniques were employed for the collection of data during one month of field work in June 1981. A questionnaire was written and administered in English and Palauan in order to offset limitations due to language differences and to enhance comprehension. This survey instrument, entitled Water Use Survey - Belau, was compiled after a review of the literature and discussions with Palauans. It was administered by the author with assistance provided by Palauan interviewer-translators from the Sanitation Laboratory, Division of Public Health in Belau, and the Palau Historical and Cultural Preservation Commission.

It should be noted that the collection of water samples from household water supplies was carried out and water quality analyses of these samples were done at the Sanitation Lab in the Koror hospital by an employee of the Water and Energy Research Institute, University of Guam. A discussion of the coliform, turbidity, and conductance analyses of the rain water samples collected in conjunction with the surveys is included below.

A total of thirty (30) usable questionnaires collected from Ngarakabesang (70%) and Koror (30%) were analyzed and comprised the data base. The use of the Statistical Package for the Social Sciences (SPSS) facilitated data analysis. A frequency distribution was run for all variables, along with cross tabulations and the chi square test of independence using the .05 level of statistical significance for particular variables.

#### SETTING

On the westernmost boundary of the geographical region known as Micronesia in the western Pacific Ocean lies the Belau Island archipelago. Belau is situated between 134°08' and 134°44' east longitudes and 6°53' and 8°12' north latitudes, approximately  $659.69 \times 10^3$  m (410 miles) north of New Guinea. The land mass is  $486.92 \times 10^3$  m<sup>2</sup> (188 miles<sup>2</sup>) and consists of volcanic islands, pinnacled limestone islands and atolls. The climate is tropical and is charac-

terized by wet and dry seasons, with the rainy season occurring from June through November and a mean annual rainfall of 3 962.4 mm (156 in.). The northeast trade winds accompany the dry season, which persists from December to May. The months of February, March, and April are considered the driest months with a recorded rainfall of 152.4 to 203.2 mm (6-8 in.) per month.

An extreme dry season and drought-like conditions during the month of May 1981 provided the impetus for this exploratory study of freshwater availability and freshwater utilization in Belau. The National Weather Service Station located in Koror recorded a total of 435.6 mm (17.15 in.) of rainfall for the months of March, April, and May (U.S. Department of Commerce 1981). This represented a deficit of 371.35 mm (14.62 in.) of rainfall from the recorded mean rainfall for the same 3-mo period for the years 1948 through 1980. In April there were 18 days with 0.25 mm (0.01 in.) of rain or less, 10 days of which were consecutive. It was during the second week of May that the Airai reservoir was depleted and the drought conditions climaxed. This severe lack of precipitation was reflected in the rainfall data recorded for the months of March 114.05 mm (4.49 in.), April 76.2 mm (3.0 in.), and the first two weeks of May 90.42 mm (3.56 in.), and in the alteration by many householders in their usual water-related activities. During this time the issue of water quality and quantity was of prime consideration and a Senate joint resolution (No. 39) calling for "declaring the Republic a disaster area and seeking foreign assistance for water" was initiated. In a survey conducted by the Palau Community Action Agency (PCAA) in 1979 to 1980, 25% of 1000 households surveyed ranked the lack of water high in their assessment of community problems (PCAA 1981).

The resident population of Belau is estimated to be 12,452, of which 64% or 8,064 reside in the district center (PCAA 1981). A population density calculated at 2,000 per square mile (Warner 1979, eq. [2]) creates heavy demands on existing freshwater resources in the district. In addition, the availability of piped water from the municipal system is irregular and enforced water hours limit water supply to 4 hours daily. Much of the island of Ngarakabesang is without the municipal water system and relies upon alternative sources of fresh water while most residences on Koror Island are connected to the municipal piped water system.

In summary, the island setting indicates a limited land mass with a concentration of population in the district center of Koror where the demand for fresh water is highest and its availability considerably lower in comparison to the abundance of surface water and sparse population on the nearby island of Babeldaob. The tropical climate is distinguished by a wet and a dry season of approximately six months duration each. Ordinarily rainfall is abundant with an annual mean of 3 962.4 mm (156 in.), although prolonged periods of little or no precipitation occasionally occur during the dry season. Given these data the significance of fresh water in Belau can now be brought into focus. Let us turn to an examination of the role of rain water cistern systems, their history, utilization, and the quality of household rain water supplies.

#### RAIN WATER CISTERN SYSTEMS: PAST AND PRESENT

Rain water cistern systems observed in Belau can be divided into two categories according to origin: historical and modern. The historical catch-



ments, constructed during the Japanese occupation of Belau (1914-1944), are characterized by technologies introduced by this foreign administration. The modern rain water catchment system include those developed during the post-World War II years until the present (1945-1981) and demonstrate Palauan ingenuity through the adaptation of foreign as well as local products.

The Japanese constructed and completed water supply systems in the large towns of the districts while the islands of Micronesia were under the jurisdiction of the Japanese colonial rule (PCAA 1978). In addition to a centralized water distribution system, such as the piped system in Koror—parts of which are in use today, the Japanese also developed an array of decentralized complexes for the procurement and containment of fresh water. These decentralized systems include small shallow reservoirs, 3 by 4 m, which were formed by the damming of streams and which incorporated existing basalt and land mass to form natural enclosures. Wells and rain water cistern systems were designed and utilized by the Japanese for the procurement, storage, and distribution of fresh water.

The concrete cisterns range in size from 60 metric tons (15,831 gal) to containers with (800-gal) capacities, and their design is cylindrical or rectangular, with surface or subsurface placement. Many of these historical rain water cisterns are in use while others, in varying stages of disrepair, have been abandoned.

Some rain water cistern systems devised by the Japanese serviced personnel at the military barracks on Ngarakabesang. Four Japanese-built 60-metric ton cisterns are located at the sea plane ramp and three of them presently supply several households with copious amounts of fresh water. The smaller historical rain water cisterns are most often associated with individual houses and, as Ehrlich (n.d.) noted, the locations of several cisterns adjacent to cement pads were associated in the past with Japanese government buildings or residences. In one hamlet of Ngarakabesang, an open cistern constructed during the Japanese times reveals a central concrete post where 4 concrete beams radiate outward toward the cistern wall of which they are a part. This structure is not unlike the one described by Ehrlich which measures 6.1 m (20 ft) in diameter with walls 0.3 m (1 ft) thick and 2.4 m (8 ft) in height. This cistern system is fed with rainfall channeled from the roofs of two nearby houses and provides water for seven households within the hamlet. It has never been known to be depleted.

Modern or contemporary rain water cistern systems are also associated with individual households. Ninety-three percent of the 29 households, which utilize either the modern or the historical rain water catchment systems, have unpainted corrugated tin roofs while the remaining tin roofs are painted. Rain water runoff from the roofs is caught by metal (or tin) gutters, polyvinyl-chloride pipes cut in half, or halved bamboo stalks which act as conduits and channel the rain water into an array of storage containers. The modern rain water storage vessels are constructed of metal, concrete, or plastic and assume a variety of sizes, primarily 0.208-m<sup>3</sup> (55-gal) metal drums.

#### RAIN WATER UTILIZATION

In Belau, the patterns of water use are well established and based upon

the water type or source, its quantity, its accessibility, and its quality. None of the households is totally reliant upon one source of fresh water. Household water supplies most often consist of the combination of rain water catchments (raim ra chill) and/or wells, piped seeps, springs, streams, or the municipal piped water system—with few exceptions. Ninety-seven percent of the households surveyed had either the historical, modern, or both types of rain water cistern system. Rain water is the primary source for drinking and for cooking, regardless of storage capabilities. Throughout various islands of Micronesia (Yap, Ponape, and Kosrae), the author has observed that rain water was frequently utilized for human consumption. The Guam and Rota fresh-water studies (Stephenson 1979; Stephenson and Moore 1980) reported a preference for drinking and cooking with rain water in those islands.

Among those households with the large storage capabilities and ample rain water supplies, this type of water is incorporated into a greater variety of uses than among those households with less stored rain water available. In addition to human consumption and food preparation, it is used for laundering, bathing, and washing cooking utensils. McCutcheon (1981, p. 190) observed that "no one relies exclusively on rain water for their bathing, washing, and drinking needs" in Melekeok at present. This is also true of households located in the Koror area which has limited rain water storage capabilities. "Among those households with less catchment storage capacity, for example, 275 gallons for a household of twelve persons, rain water was restricted to food preparation and drinking purposes" (O'Meara). Contained rain water is generally not used for bathing and laundering, and water provided for plants or animals is derived from other sources. The limited use of this water source in water-related activities, other than ingestion or cooking, coincides with the household capacity for rain water storage.

Respondents were asked to comment on the limitations of rain water or if they considered rain water to be a limited resource. Seventy percent responded affirmatively and indicated rain water had its limitations to a certain extent. Several respondents viewed climatic conditions, the lack of rainfall, as a primary limitation. The number or the size of household rain water storage containers or the design of the cistern system such as an inadequate roof or gutter were considered to be the primary reasons rain water was viewed as a limited resource. Once again, a few households with vast rain water cisterns and storage capacity did not consider rain water to be limited.

Rates of rain water consumption over time were explored in an effort to gain an impression of water consumption patterns. The consumption rate was not quantified in terms of the number of gallons consumed during the span of a year; instead, the consumption rate was examined through a combination of the respondent's perceptions of changes in the quantity of water utilized by their household over the past year, alterations in water usage, and changes in the number and size of water storage containers. Had the need for fresh water increased, decreased, or remained the same for the household's demand for water to be adequately met?

Several households reported an increase in the preparation of staples which were prepared with rain water and consumed daily, while several others reported a growth in family size prompted the need for additional water. Over the past year, 43% of the sample respondents felt the amount of water required for their household needs had increased (Table 1). Forty-seven per-

TABLE 1. REPORTED CHANGES IN WATER CONSUMPTION PATTERNS,  
JUNE 1980-JUNE 1981

Rates	Amounts of Water for Family Needs		No. of Storage Containers		Storage Size of Containers	
	(No.)	(%)	(No.)	(%)	(No.)	(%)
Increase	13	43	8	29	4	17
Decrease	3	10	6	21	1	4
No Change	<u>14</u>	<u>47</u>	<u>14</u>	<u>50</u>	<u>19</u>	<u>79</u>
Total	30	100	28	100	24	100

SOURCE: O'Meara (n.d.).

cent noted no change, while a decrease in required water was cited among 10% of the respondents. The changes in the number of rain water storage containers were minimal: 50% reported they had the same number of cisterns as last year, 29% indicated an increase in the number of containers, and 21% noted a decrease.

The size of storage vessels for rain water fluctuated minimally over the past year: 79% indicated no changes in household water container sizes, although 17% reported an increase. As previously noted, the 0.204-m<sup>3</sup> (55-gal) drums are the most common form of rain water cistern. They are more affordable and more easily obtainable than larger tanks or cement structures. Consequently, it is not unusual that the container sizes reflect little change.

The water consumption patterns in Belau have remained fairly consistent during this time with minor fluctuations in water use; however, a slight increase was most discernible with regard to the amounts of water required to meet household needs. The minimal increases in both the size and the number of water storage containers, combined with the perceived increase in water requirements, hint of a general increase in the rate of water consumption. Clearly, there is a need for further investigation of consumption trends and the utilization of quantitative measures to gain a clearer picture of water consumption rates and patterns.

Several questions in the questionnaire were designed to examine water tenure, that is, who is responsible for various freshwater resources and whether or not they are controlled. Regarding the responsibility for the condition of rain water catchments, the family members or individual users of this resource were considered responsible. The maintenance of household water catchments was viewed as the responsibility of each household.

#### CLIMATIC INFLUENCES

During the 1981 dry season, drought-like conditions prevailed in Belau for several weeks and resulted in the modification of many households' usual water-related activities and practices. Table 2 is a comparison of major household water supplies during normal weather conditions versus the drought. One-third of the households indicated rain water catchments were their most important water source during normal weather conditions. Fewer than 25% identified wells as their most common water source, and the combination of a well

TABLE 2. MAJOR HOUSEHOLD WATER SOURCES DURING NORMAL AND DROUGHT WEATHER CONDITIONS

Household Water Sources	WEATHER CONDITIONS			
	Normal		Drought	
	(No.)	(%)	(No.)	(%)
Catchment .....	9	32	7	23
Well and Spring .....	7	25	16	53
Well and Catchment .....	3	11	0	0
Stream .....	3	11	5	17
Pipe Water (Municipal) ...	3	11	1	3
Piped and Well or Well and Catchment .....	3	11	1	3

SOURCE: O'Meara (n.d.).

NOTE: Percentages rounded off.

and a catchment was cited by 11%. Combinations of the municipal piped water system and a well, or the piped system and catchment were reported as primary sources among 11% of the surveyed households.

During the drought, there was a noticeable increase in the utilization of wells and a reduction in the reliance upon catchments; thus, a greater dependence on groundwater sources was observed. Dependence upon the municipal water sources was observed. Dependence upon the municipal water system was also reduced because it was supplied by the Airai reservoir which became depleted. The households most affected were those which relied upon rain water for the majority of their water needs and had limited storage capabilities, and those which relied heavily upon the municipal water system, particularly residents of the densely populated district center. The primary water related practices affected by the drought were bathing, laundering, and domestic chores. Several households with access to wells, streams, or sizeable rain water cisterns indicated little disruption of their usual water use activities during the drought.

It should be noted that there is usually sufficient rainfall during most of the year to keep a 0.208-m<sup>3</sup> drum completely full all of the time. "In the event that the smaller water catchment systems become depleted (during the more severe dry seasons), households can easily obtain water from friends or relatives" (O'Meara, n.d.) or they can utilize public water sources.

#### RAIN WATER QUALITY AND SAFEKEEPING

Precautionary measures for drinking water supplies were categorized as (1) the treatment of the water and (2) the maintenance of the rain water cistern system. Ninety percent of the surveyed households indicated that they took precautions for the safekeeping of their drinking water while the remaining 10% stated that no precautions were necessary for rain water. The catchment system maintenance primarily involves steps taken to maintain the storage containers and includes painting the 0.208-m<sup>3</sup> drums, covering them with screens or lids, or a combination of these steps. Screens and lids have been

effective in hampering mosquito life cycles and minimizing contamination from dust and the debris from foliage. One-half of the respondents maintained the storage vessels in the manner described above, while one-third of the households modified their cisterns and treated the water by boiling it.

During the drought, several households utilized liquid bleach (Clorox) as a form of treatment for drinking water and well water. A pamphlet published by the Public Health Agency (1980) outlines a procedure for adding chlorine to household water supplies which is designed to hamper algal, bacterial, and parasitic growth. This method serves as the basis for the Belau Sanitation Laboratory's instructions for water purification during the drought. The bleach-to-water ratio suggested in the literature is one tablespoon of bleach per 0.04 m<sup>3</sup> (11 gal) of water so that a 0.208 m<sup>3</sup> (55-gal) drum filled to capacity requires 5 tablespoons of bleach. Among respondents who disinfected their water supplies with bleach, the ratio of bleach to water varied considerably. The safekeeping of household water supplies demonstrates an active involvement by Palauans in the maintenance of drinking water and is indicative of the importance placed upon its safety or quality.

Biological aspects of rain water quality were more closely investigated through the analysis of coliform bacteria levels, turbidity, and conductance, the results of which are presented in Table 3. The amount of coliform bacteria measures the potential for disease and it is used as an indicator of additional bacterial contaminants. The absence of coliform bacteria colonies in a 100-ml sample serves as the drinking water standard for a municipal water system serving 1,000 or more consumers (APHA, AWWA, and WPCF 1975). Five of the 8 rain catchments sampled were free of coliform bacteria. On the other hand, the presence of coliform colonies in three of the samples ranged from less than 100 colonies/100 ml to no more than 550 colonies/100 ml.

TABLE 3. COLIFORM, TURBIDITY, AND CONDUCTANCE OF HOUSEHOLD RAIN WATER CISTERN SYSTEMS

Parameters	Rain Water Cistern Sample	
	(No.)	(%)
Total Coliform (colonies/100 ml)		
0 .....	5	62
<100 .....	2	25
100-550 .....	1	13
Total .....	8	100
Turbidity (NTU) per 30 ml		
0- 2.0 .....	6	75.0
2.1- 5.0 .....	1	12.5
5.1-10.0 .....	1	12.5
Total .....	8	100.0
Conductance (µmhos) per 5 ml		
<100 .....	8	100

SOURCE: O'Meara (n.d.).

Foreign particles present in contained rain water are derived from organic matter, such as dust and debris from plants and animals or from inorganic matter, such as rust from roofs, gutters, and metal containers. These particles promote an environment conducive to bacterial growth. The turbidity data in Table 3 suggest that turbidity levels of less than 2.0 NTU per 30 ml were present in three-fourths of the samples while one-fourth were found to have measurements that did not exceed 10 NTU.

The capacity of water to conduct electricity is based upon the salt content present in the water, as salts are excellent conductors of electrical current. Conductance measurements for all of the rain water samples were less than 100  $\mu$ mhos/5 ml, which indicates little or no presence of salts (Table 3). Despite the small data base reported in Table 3, the quality of rain water as measured in levels of coliform count, turbidity, and conductance is consistent with low measurements reported elsewhere for this water source and indicates a relatively clean and safe source of water.

#### SUMMARY AND CONCLUSIONS

Throughout Belau most households rely upon more than one source of fresh water, and rain water catchments are an integral part of the procurement system. In addition to rain water cisterns, household water supplies are supplemented by surface or shallow groundwater sources. Patterns of freshwater usage are well established in this region.

Regardless of household capacities to collect and store rain water, it is the primary source of potable water and its preference in food preparation as well as for drinking is widespread. Households with facilities to store copious amounts of rain incorporate it into a variety of water-related activities but for households with lesser storage capacities rain water use is limited to drinking and to cooking; thus, rain water availability influences the utilization of this resource. Inadequate storage or faulty design of cistern systems was cited as major reasons most respondents viewed rain water as a limited resource. Climatic conditions also affect the availability or quantity of rain but few respondents cited this as a limiting factor despite experiencing drought conditions within a month prior to this study. The drought affected usual water-related activities and many households accordingly modified these activities.

Palauans are actively involved in the maintenance and safekeeping of their household water supplies and this is indicative of the importance placed upon safe drinking water. The maintenance of rain water cisterns is the responsibility of each household and 90% of the surveyed households take precautions for either the maintenance of the storage vessels or the water itself. Laboratory analysis of coliform, turbidity, and conductance of rain water samples from eight households suggest the quality is consistently adequate, yet it does stand the risk of contamination from organic and inorganic pollutants.

There appears to be a gradual yet observable increase in the demand for fresh water, an increase which is most discernible in the amounts of water required to meet present household needs compared with the amounts of water needed one year ago. This increase combined with the slight increases reported in the size and the number of storage vessels hint at a rise in the rate of rain water consumption. Clearly, this topic requires further study using quan-

titative measures to obtain a more accurate picture of consumption patterns. Future studies could also expand upon the focus presented in this paper: relationships between cistern systems and utilization, quality, and climate, bearing in mind that freshwater use results from deliberate human action, and the source, quantity, accessibility, and safety comprise fundamental criteria by which water use may be determined.

## REFERENCES

- American Public Health Association, American Water Works Association, and Water Pollution Control Federation. 1975. Standard methods for the examination of water and wastewater. 14th ed. Washington, D.C.: American Public Health Association. xxxix + 1193 p.
- Austin, Smith and Associates, Inc. 1974. A report covering the Koror water system. Honolulu, Hawaii.
- Ehrlich, P. n.d. Oreor: A center of power, commerces, and colonial administration. Micronesia Archeology Series, Historic Preservation Office, Trust Territory of the Pacific Islands, Saipan. (in press)
- Hawaii Architects and Engineers, Inc. 1980. Palau water preliminary engineering report executive summary. Honolulu, Hawaii.
- \_\_\_\_\_. 1978. Water treatment and development presentation report for the Koror municipality water system Palau district Trust Territory of the Pacific islands. Honolulu, Hawaii.
- McCutcheon, M.S. 1981. "Resource exploitation and the tenure of land and sea in Palau." Ph.D. dissertation, Univ. of Arizona, Tucson.
- O'Meara, C. n.d. An investigation of social aspects of fresh water use in selected hamlets of Belau. Micronesian Area Research Center, Univ. of Guam. (in press)
- Palau Community Action Agency. 1981. Program planning committee meeting. Koror, 7 January.
- \_\_\_\_\_. 1978. History of Palau: Japanese administration vs. naval military government. Vol. 3, Guam.
- Public Health Agency. 1980. Public health news. Government of the Commonwealth of the Northern Mariana Islands, Saipan, April/May.
- Stephenson, R., ed. 1979. Fresh water use customs on Guam: An exploratory study. Tech. Rep. No. 8, Water Resources Research Center, Univ. of Guam.
- \_\_\_\_\_, and Moore, D., eds. 1980. Fresh water use customs on Rota: An exploratory study. Tech. Rep. No. 17, Water Resources Research Center, Univ. of Guam.
- U.S. Army, Chief of Engineers. 1956. Military geology of Palau Islands, Caroline Islands. Intelligence Division, Headquarters U.S. Army Pacific.
- U.S. Department of Commerce. 1981. Local climatological data. National Weather Service, Koror Island, Palau.
- Warner, D.C.; Marsh, J.A.; and Karolle, B.G. 1979. The potential for tourism and resort development in Palau: A socio-economic-ecological impact study. Univ. of Guam.

## ROOF CATCHMENTS: THE APPROPRIATE SAFE DRINKING WATER TECHNOLOGY FOR DEVELOPING COUNTRIES

B.Z. Diamant, Professor  
Department of Water Resources  
and Environmental Engineering  
Ahmadu Bello University  
Zaria, NIGERIA

### INTRODUCTION

Water is one of the major components in the structure of the human environment; it comprises nine tenths of our body and covers three quarters of our world. However, as much as water can support and preserve life, it can also damage and destroy it when this basic commodity is contaminated prior to consumption. There are various sources of water contamination, but the most dangerous source is considered to be human waste originating from sick people infected mainly with intestinal diseases, like typhoid fever and cholera, or from healthy carriers of these diseases. History, in particular medieval history, has been recording numerous outbreaks of water-borne diseases that wiped out whole communities.

Unfortunately, despite the remarkable technological achievements of our era, dangerously contaminated water supplies still pose a serious threat for a large portion of the world's population. Salas (1981), of the United Nations Fund for Population Activities, has estimated the 1980 world's population at 4.4 billion. According to recently released World Health Organization (WHO) figures (World Water 1981), the number of people that lived without access to safe drinking water in 1980 has been estimated at 1,320 million, comprising 30% of the world's population (the ratio is actually higher because the WHO figures did not include China). Almost all these less privileged people resided in developing countries where they comprised more than half of the population. In this respect, it has been further concluded that mostly affected were the rural areas where an overwhelming majority of developing countries people live.

These distressing environmental facts were among the main reasons leading to the recently inaugurated International Drinking Water Supply and Sanitation Decade (IDWSSD) 1981-1990 aimed at "providing safe water and proper sanitation for all by the year 1990." It is universally hoped that this most human expectation will come true but, meanwhile, together with the time consuming, large-scale water resources development activities connected with the IDWSSD, it is essentially important to embark as soon as possible on ways and means aimed at providing immediate, though limited, solutions for the steadily growing safe drinking water problem in the developing world. A large-scale development of roof catchment drinking water supplies can be the appropriate answer for this problem due to the relatively low costs of the method, but mainly because it provides an almost entirely safe, raw drinking water supply that does not require costly and complicated purification processes.

The United Nations Environmental Programme (UNEP) has recently embarked on a large-scale Water Harvesting Programme, whose first phase is now being



concluded. Its objective was to generate "knowledge synthesis" through documenting selected rainwater harvesting techniques. The International Reference Centre for Community Water Supply and Sanitation (1981) that has been assisting the UNEP's project has righteously stated, in this respect, that "rainwater fails to receive the attention it deserves as a potential useful element in the rural water supply programmes of developing countries." In the present state of community water supply in developing countries, roof catchments can be considered as the most appropriate technology for providing the population with safe drinking water.

#### WATER SUPPLY IN DEVELOPING COUNTRIES

Water is a matter of life and death in its real sense: it maintains life on one hand, but can be also fatally dangerous on the other hand when it contains pathogenic organisms. The fact that these organisms cannot be detected by man's senses causes contaminated drinking water to be so dangerous. Developed countries have been tackling for generations the major environmental issue of providing safe drinking water for their people. During the years, efficient and effective water purification methods were developed and implemented so that, nowadays, almost every person—including those living in the rural areas—have access to safe drinking water.

In developing countries, the situation is, unfortunately, entirely reversed and the majority of the people are constantly exposed to dangerous health hazards of consuming contaminated drinking water. Most affected in this respect are the rural people. Unlike developed countries where most people live in urban communities, the majority of people in developing countries live in rural areas. According to the West-German Statistics Bureau (1979), for example, in 1978 only 3.7% of the 61.4 million people were living in communities smaller than 1,000 people. While a survey carried out by the World Health Organization (1973), has shown that the rural population in the developing countries amounted to 72%. In certain typical developing zones like the African continent, for example, this ratio was far higher and reached 83% (WHO 1976).

The World Health Organization (1976) has carried out during the previous decade a Global Survey on Water Supply and Waste Disposal in the Developing Countries. An interim report on the survey, covering the first half of the decade, was released in 1976 and revealed alarming facts. The survey discovered that in 1970 only one out of seven rural people had access to safe drinking water. The urban sector was far better off with three out of four urban people enjoying the safe water supplies. A slight improvement has been noticed in the rural zone in 1975 when the above ratio increased to 1 to 5 (instead of 1:7) with almost no change in the urban zone. Based on these findings, as well as on an expected tremendous investment in water supply development during the second half of the decade, the interim report contained also predictions and assumed targets for 1980. According to these expectations, "only" two out of each three rural people will not drink disease-free water in 1980, whereas, over 90% of the urban population will enjoy by then safe water. But unfortunately, even these humble hopes did not come true. According to recent information provided to WHO by developing countries (excluding China) on their water supply situation in 1980 (World Water 1981), the provision for safe drinking water did not only lack any improvement but has even

deteriorated. Out of the 1,612 million rural people that lived in the developing countries in 1980, only 469 million or 29% had access to safe drinking water, which means a 7% drop from the predicted 36% (Table 1). An even sharper drop has been noticed in the urban sector where out of 703 million people, 526 million were provided with safe water supplies which represent 75% and a drop of 16% from the predicted 91% for 1980 (Table 2).

TABLE 1. SAFE DRINKING WATER AVAILABLE IN DEVELOPING COUNTRIES, 1970-1980

YEAR	PERCENT OF POTABLE WATER		
	Urban	Rural	Avg.*
1970	76	14	29.0
1975	77	22	37.4
1980†	91	36	51.4
1980‡	75	29	43.0

\*Based on 28:72 rural/urban population ratio.

†Predicted.

‡Surveyed.

TABLE 2. POPULATION AND PEOPLE SERVED WITH SAFE DRINKING WATER SUPPLIES IN DEVELOPING COUNTRIES, 1980

Sector	Population (million)	People Served (million)	%
Urban	703	526	75
Rural	1,612	469	29
Total	2,315	995	43

The WHO findings, as well as the recent 1980 information on the poor state of water supply in the developing countries, clearly demonstrate that the core of the problem lies in the rural areas where an overwhelming majority of the population lives. It is, therefore, a rural problem which has to be accordingly tackled. The repercussions of the present situation are very grave. For example, out of the 13.6 million children up to the age of 5 that died in the world last year, according to WHO records (1980), 13.1 million lived in developing countries. Most of these deaths were caused by water-borne diseases, transmitted by contaminated water, and "could have been, therefore, potentially prevented."

INTERNATIONAL DRINKING WATER SUPPLY AND SANITATION DECADE (IDWSSD). WHO survey findings have had a strong impact on the United Nations Water Conference held in Mar-del-Plata, Argentina, in March 1977. It was unanimously agreed in the Conference that the water supply and sanitation problems in the developing world required an urgent solution. Thus, conference's Priority Action Plan stipulates "a commitment of all national Governments to provide all people with water of safe quality and adequate quantity and basic sanitary facilities by 1990."

The International Drinking Water Supply and Sanitation Decade is considered to be one of the most ambitious United Nations program. Its cost has been estimated at \$300 billion or \$30 billion a year during the 10-yr period of the program. However, this great human project will mainly provide the long-term solution for the global water supply problem, which means a non-immediate solution for millions of people already constantly exposed to the risks of consuming unsafe drinking water. An immediate temporary solution is, hence, required within the context of the IDWSSD. Roof catchment seems to be an appropriate solution of this kind because it is economical and simple to construct and comprises a safe raw water supply.

#### THE ROOF CATCHMENT DRINKING WATER SUPPLY

SCOPE. A roof catchment program for rural areas in developing countries, within the context of the IDWSSD, is meant to provide an immediate, though limited, safe—for drinking purposes only—water supply free of fecal contamination which is the cause for most water-borne diseases—mainly the diarrheal diseases. It should be noted that diarrheal diseases have been considered to be the main cause of death in all developing countries (Cairncross et al. 1980). These diseases include mainly cholera, typhoid and paratyphoid fevers, bacillary and amoebic dysenteries and salmonellosis.

There is little likelihood that fecal organisms will contaminate roof catchment rain water. Other foreign material that could enter the collected rain water, such as dust, leaves, bird or lizard droppings could have a negligible effect in comparison to fecal contamination and therefore will not be discussed. The scope of the roof catchment program will, hence, include the provision of water free from fecal contamination and restricted only to drinking purposes. This restriction is very important in view of the fact that most rural hamlets in developing countries are small and can therefore provide a small catchment area. A roof catchment program of this nature must be accompanied by elaborate health education activities that will explain—and convince—the people to preserve the precious collected rain water only for human consumption. Collected rain water is normally very soft and, therefore, ideal for washing and laundry purposes. This fact is known to rural women, and in particular to those living in areas where the surface water supply from shallow wells or nearby rivers is quite hard. A health education campaign is very important in such circumstances to save and preserve the limited safe and clean rain water for drinking purposes.

DRINKING WATER CONSUMPTION. Only a small fraction of the domestic water supply is used for drinking purposes. Thus, various authors have asked why the entire domestic water consumption should receive costly purification treatment stages when only a very small part of it is used for drinking purposes. It has been, however, unanimously agreed that maintaining two different supply lines, one for domestic use and a smaller one for human consumption, might be too complicated and dangerous, mainly for children who are liable to mix the lines. The entire domestic water supply should therefore be purified to provide safe drinking water standards.

In many rural areas in developing countries, local water supplies diminish and are barely adequate during dry seasons. During drought periods which are quite frequent in parts of Africa and Asia, even the smallest quantities of

water required for drinking are sometimes not available. What is the minimum quantity of water needed for survival in tropical areas? This issue has been investigated in various parts of the world. White (1972) stated that "the minimum for survival in a tropical area can be regarded as in the range of 1.8-3.0 litres daily." Feachem (1978) reported on large differences in drinking water consumption in different countries. For example, in Papua the minimum rate was found to be 0.54 l/person/day, whereas in Uganda the rate was 3.4 l/person/day. In the present grave water supply situation, it seems that a rate of 2.0 l/person/day can be considered as a reasonable design figure for rural roof catchment drinking water supply programmes in developing countries.

**DESIGN.** The design of a roof catchment is very simple. It depends on two main factors: the area of roof catchment and the annual rainfall. The latter is usually obtained from meteorological records and is expressed in millimetres per year. The mean annual figure, which is required for design purposes, is calculated according to the longest available period of years of available rainfall data. The normal period in this respect is 50 years, if data is available.

Not all the rain reaching the catchment area is available for collection and storage due to various losses. Fair (1971) counted four main losses of water in the catchment, namely, evaporation, rain blown away by winds, water lost in depressions in the roof, or improperly pitched gutters and the wash water used in the first flush. According to Fair (1971), these losses include one third of the annual rainfall, and is most noticeable for large catchment areas, like American farm roofs with areas of 300 m<sup>2</sup> or more. Wagner (1959) recommended for rural areas in developing countries, roof catchment losses of one fifth or 20% of the rainfall due mainly to evaporation. However, 25% of the annual rainfall can be considered as a reasonable loss for small hamlets in rural areas in developing countries.

The roof catchment drinking water supply method is mainly meant to provide safe drinking water for the rural family during the dry season. This season has an average length of 100 days, during which no rain might be available to fill the reservoir. Based on the above-mentioned minimum drinking needs of 2 litres per person per day, an average five-member family will require a storage capacity of  $(5 \times 2 \times 100) = 1000$  l or 1 m<sup>3</sup>. If this family is living in a typical mud house, with a 25-m<sup>2</sup> area in a location having a modest mean annual rainfall of 400 mm, the hamlet's roof will hence collect  $(25 \times 0.400) = 10$  m<sup>3</sup> of rain water. Evaporation will reduce it by 25% allowing 7.5 m<sup>3</sup> to enter the reservoir. The ratio of 7.5 between the available water and the capacity of the reservoir will enable the latter to remain full during lengthy periods of secured safe drinking water supply.

Since a very large number of people will require this safe drinking water supply method, its design has to be geared towards mass production, which means mainly simplicity and economy, so that the beneficiaries might be able to afford the cost, or most of it, and to construct the device under suitable guidance. The three main design features of the device include the roof, the gutters and the reservoir.

**Roof.** The catchment area of the roof is composed of corrugated galvanized iron sheet sheets or aluminum sheets and sloped to enable the rain water to flow to the gutters. Most houses involved in the roof catchment program might

already have thatched roofing that will have to be replaced with corrugated sheeting. The roof catchment device has, therefore, a double advantage: it provides safe drinking water and also improves housing conditions (Diamant 1980). In view of the relatively small individual roofing areas, the construction of the roof is recommended to be a single slope. This will result in a considerable saving in the gutters and the ridge. The slope should be directed towards the entrance of the house so that the reservoir can be easily available at the front of the house.

**Gutters.** In the one-slope roof system only one gutter will be sufficient for the system. The pipe leading from the gutter to the reservoir should be raised about 1 cm above the bottom of the gutter, and capped with a galvanized net having 1-cm<sup>2</sup> openings to prevent large leaves and birds from entering the reservoir. The slightly raised pipe in the gutter enables the sediments to settle in the gutter rather than to enter the reservoir. It is not recommended to raise the pipe in the gutter more than 1 cm to prevent mosquito breeding in the accumulated water in the gutter.

**Reservoir.** The reservoir should be made of galvanized-iron sheets of standard size to provide a 1-m<sup>3</sup> capacity. The construction of the reservoir, as well as the gutters, should be made at the site in the village. Lead welding which is normally used for such works requires simple equipment that can be used at the site. The required heating can be provided by gas, or liquid-fuel torches. Local construction will considerably reduce transportation costs when the sheets can be loaded compactly. The reservoir should be provided with an outlet 5 cm above the bottom to prevent sediments from running out through the tap. The tap should be equipped with a lock to prevent water wastage mainly by children. An overflow outlet should be fixed at the top to let out excess water when the reservoir is full. The reservoir should be laid on wooden supports placed on a raised platform to enable easy drawing of water. The outer bottom must always be kept dry to prevent corrosion. The most economical shape of the reservoir, as far as material saving is concerned, is a cylinder with the diameter equal to the height.

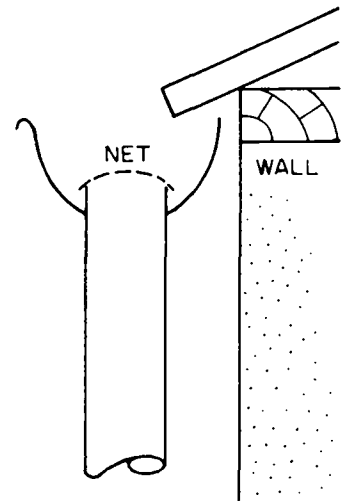

It should be noted that the roof catchment system incorporates also an indirect purification of the stored water. Wagner (1959) stated that simple holding of water in a reservoir will reduce the total number of bacteria originally present because they die off faster than they reproduce.

#### ROOF CATCHMENT CAMPAIGN

Although every individual householder can install a roof catchment water supply system, the trend should be encouraged by an organized campaign led by an official body, which is, in most cases, the health authority. The campaign should be aimed towards a demonstration effort. Therefore, a central village in a group of villages should be chosen for demonstration. The first stage will include preliminary meetings with the leaders of the community to obtain

their cooperation and support. This will be followed by health education activities among the people, emphasizing the need and importance of clean drinking water, in particular for children; describing with the aid of models the operation of the system and promising the full support and actual aid of the campaign authority. Publicity must follow these activities to raise similar interest in neighboring villages.

The contribution of the campaign authority should include organization, instruction and guiding services, as well as attractive incentives for members in the community who cooperate. For example, a householder who will deposit the money for the purchase of roofing materials and the reservoir and prepare the elevated platform for the reservoir, will be awarded with a free gutter, pipe and outlet tap equipped with a locking system. The governmental authority will also bear the cost of transporting the materials and the work of the artisans brought to the site to construct the reservoirs and gutters.

As a rule, authorities should not be involved in any collection of funds from the participating villages. This should be carried out entirely by the community local leaders who will also make the payments to the relevant wholesalers for the materials required for construction.

Special efforts should be exerted by the campaign organizers at the demonstration sites because their success or failure will determine the spread of these environmental health activities over the neighboring villages. Campaigns of this kind have been successfully organized by the writer in villages in western Kenya with the aid of the Ministry of Health in Nairobi.

Finally, it is important to point out that promotion of environmental health in a community can be achieved only through a simultaneous integrated effort carried out in various environmental fields, of which water supply is one of them. The involved health education activities should not concentrate only on the important safe drinking water aspect, but include also relevant matters such as housing, food hygiene and, in particular, waste disposal. It is simply unacceptable to provide a village with safe drinking water and to ignore proper human waste disposal facilities. The situation of human waste disposal in the rural areas in developing countries is far more severe than the water supply situation described earlier. The solution for the problem is also far simpler and less costly than the proposed solution for the safe water supply problem. The appropriate solution is a simple design of a pit-latrine (Diamant 1978) that can be constructed by the householder with cheap, locally available materials. Safe water supply and proper waste disposal are two inter-related and complementing issues that have to be developed together in the promotion of environmental health.

#### REFERENCES

- Cairncross, S.; Carruthers, L.; Curtis, D.; Feachem, R.; Bradley, D.; and Baldwin, G. 1980. *Evaluation for village water supply planning*. Chichester: Wiley.
- Diamant, B.Z. 1978. Pit latrines. In *Sanitation in Developing Countries*, ed. A Pacey, chap. 6. Chichester: Wiley.

- Diamant, B.Z. 1980. The appropriate technology of promoting safe water supply in Africa. *Aqua Scientific and Technical Review*, no. 3, Int. Water Supply Assoc. London: Marlborough.
- Fair, M.F.; Geyer, J.C.; and Okun, D.A. 1971. *Elements of water supply and wastewater disposal*. New York: Wiley.
- Feachem, R.G.; Bradley, D.J.; Garelick, H.; and Mara, D.D. 1978. *Health aspects of excreta and wastewater management*. Washington D.C.: World Bank.
- International Reference Centre for Community Water Supply and Sanitation. 1981. Rainwater harvesting. *IRC Newsletter*, no. 121, May 1981.
- Salas, S. 1981. *Report of the United Nations Fund for Population Activities—1980*. New York: United Nations.
- Wagner, E.G., and Lanoix, J.N. 1959. *Water supply for rural areas and small communities*. Monograph Series no. 42, World Health Organization, Geneva, Switzerland.
- West-Germany Federal Statistics Office. 1979. *Population distribution—1978*. Weisbaden, West-Germany.
- White, E.F.; Bradley, D.J.; and White, A.V. 1972. *Drawers of water*. Chicago: University of Chicago Press.
- World Health Organization. 1973. *World health statistics records*. vol. 26, WHO, Geneva, Switzerland.
- World Health Organization. 1976. Community water supply and wastewater disposal. *WHO Chronicle* 30(8). WHO, Geneva, Switzerland.
- World Health Organization. 1980. *Second consultative meeting on the International Drinking Water Supply and Sanitation Decade*. WHO/CWS/80.2, WHO, Geneva, Switzerland.
- World Water. 1981. *D-day for the water decade*. World Water, Liverpool, United Kingdom.

## RECENT INITIATIVES IN RAIN-TANK SUPPLY SYSTEMS FOR SOUTH AUSTRALIA

Peter J. Hoey  
Planning Engineer  
Engineering and Water Supply  
Department of South Australia  
AUSTRALIA

Stephen F. West  
Planning Engineer  
Engineering and Water Supply  
Department of South Australia  
AUSTRALIA

### INTRODUCTION

Much of Australia is arid and experiences a high evaporation rate (Fig. 1). In these areas, lack of rainfall combined with high potential evaporation results in a scarcity of surface water in the form of permanent lakes and streams.

With a population of 14 million concentrated in large coastal cities, domestic water supply in Australia is most commonly provided by conventional reticulated systems, which draw water from large surface storages or from groundwater.

Besides being a necessity in many country areas, rainwater tank/roof collection systems have been and still are popular as adjuncts to urban water supplies in Australian towns and cities. This is particularly so in areas where the quality of aesthetic properties of the reticulated supply are poor. Adelaide, the capital city of South Australia is one such city.

A large proportion of Adelaide's water supply is drawn from the River Murray, a river beset with the problems familiar throughout the world today, of rising salinity levels, increasing nutrient loads, turbidity, and algal blooms. The Australian media has for many years publicized the Murray's plight, with interest rising dramatically in recent years as the result of widespread drought conditions.

The South Australian Government and the public are concerned about deteriorating reticulated water quality, particularly that originating from the River Murray. There is a growing awareness of the benefits of rainwater systems in terms of water conservation and quality.

This paper discusses two recent government initiatives: a rainwater tank promotion campaign, its aims, its strategy and its results; and research work undertaken to gain a better understanding of raintank processes and demands, for incorporation into improved computer models designed to predict the reliability of rainwater tank/roof catchment systems.

### RAINTANK PROMOTION CAMPAIGN

The South Australian Government is well aware of the reputation of much of the state's water supply and has sought to promote greater use of domestic raintank water supply systems.



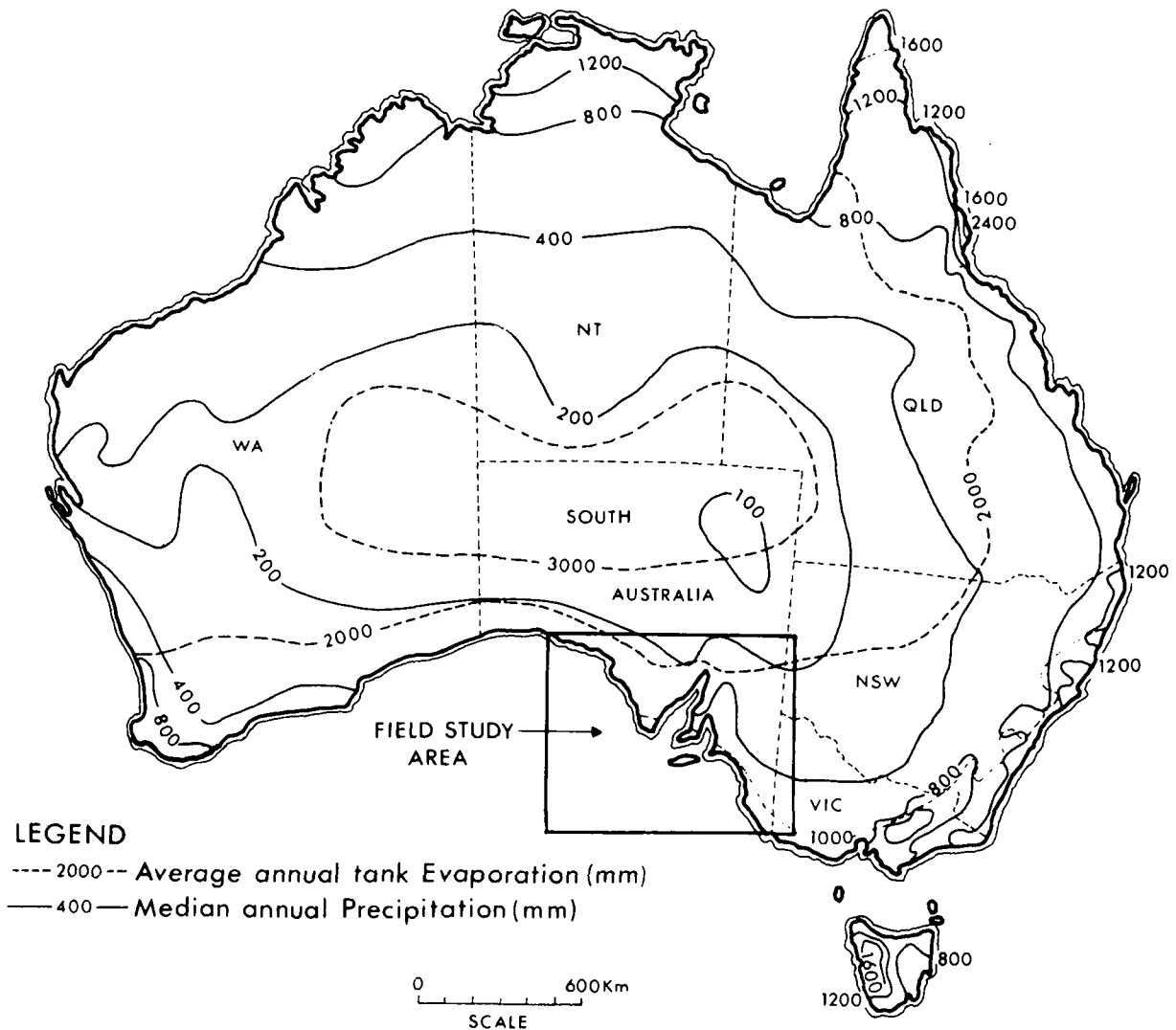

Figure 1. Australian median annual rainfall and pan evaporation

The anticipated benefits are twofold:

1. Rain tanks used as a source of domestic supply could reduce demands on other water sources by up to 4% (Engineering and Water Supply Department 1978). This, coupled with other demand management initiatives, such as the encouragement of low water use native plants in gardens, will help to delay further augmentation of headworks and reticulation systems.
2. Ownership and conscientious use of a raintank system by householders is hoped to result in increased consumer awareness in and the practice of water conservation and management.

Several factors are currently helping to promote greater use of raintank water systems in South Australia. These are

1. Media and government stimulated concern at the poor quality of Adelaide water, particularly that pumped from the River Murray
2. Increased unit charges for water (currently \$0.32 Aust. or \$0.36 U.S. per kilolitre)
3. A growing desire among some householders to become less reliant on infrastructure provided by government authorities
4. Government promotion of tanks as a useful adjunct to water supply systems in urban areas.

To assist the promotion campaign, a booklet has been produced entitled, "Rainwater Tanks—Their Selection, Use and Maintenance." The booklet summarizes and simplifies the findings of two previous investigations: one, the size requirements of tanks for different demand criteria in different climatic regions; the other, an investigation into health aspects.

Advice is given on demand requirements for various uses (e.g., bathing, laundering, dishwashing) which, when coupled with the size of family being serviced, can be used to calculate a demand level.

A map is provided in the booklet dividing the state into climatic zones. By determining the zone in which a dwelling is located, the "man in the street" tank designer can then turn to the appropriate nomograph relating his roof area and tank size, calculated demand, and his acceptable probability of failure.

This allows the designer to trade off tank size and, thus, the expense of installation against the reliability of supply. Where a reticulated supply is available, reduced reliability is acceptable. A nomograph for the urban foothills area of the capital city, Adelaide, is shown in Figure 2.

For citizens who might have difficulty using the nomographs, a telephone advisory service is provided. In addition, rough "rule-of-thumb" advice on typical tank sizes recommended for an average four person family are provided according to extent of use.

Besides tank design, information is also provided on the following.

- **INSTALLATION AND MAINTENANCE.** Tank owners are recommended to keep gutters clear of leaves, dead animals and birds, and to make sure that inlet strainers are clear. It is also recommended that the sludge that collects in the bottom be washed out once every two years.
- **ROOFING MATERIALS AND PAINTS.** Collection of water off roofs painted with lead based paints is definitely discouraged. Tar based roof coatings can impair the taste of water, and it is recommended that at least the first three runoffs from acrylic painted roofs and cement or metal tiles should be discarded.
- **MATERIALS AND COSTS.** In Australia, tanks are available in all shapes and sizes and in a variety of different materials. The tank owner is advised to be aware of the added costs besides the cost of the tank itself, which

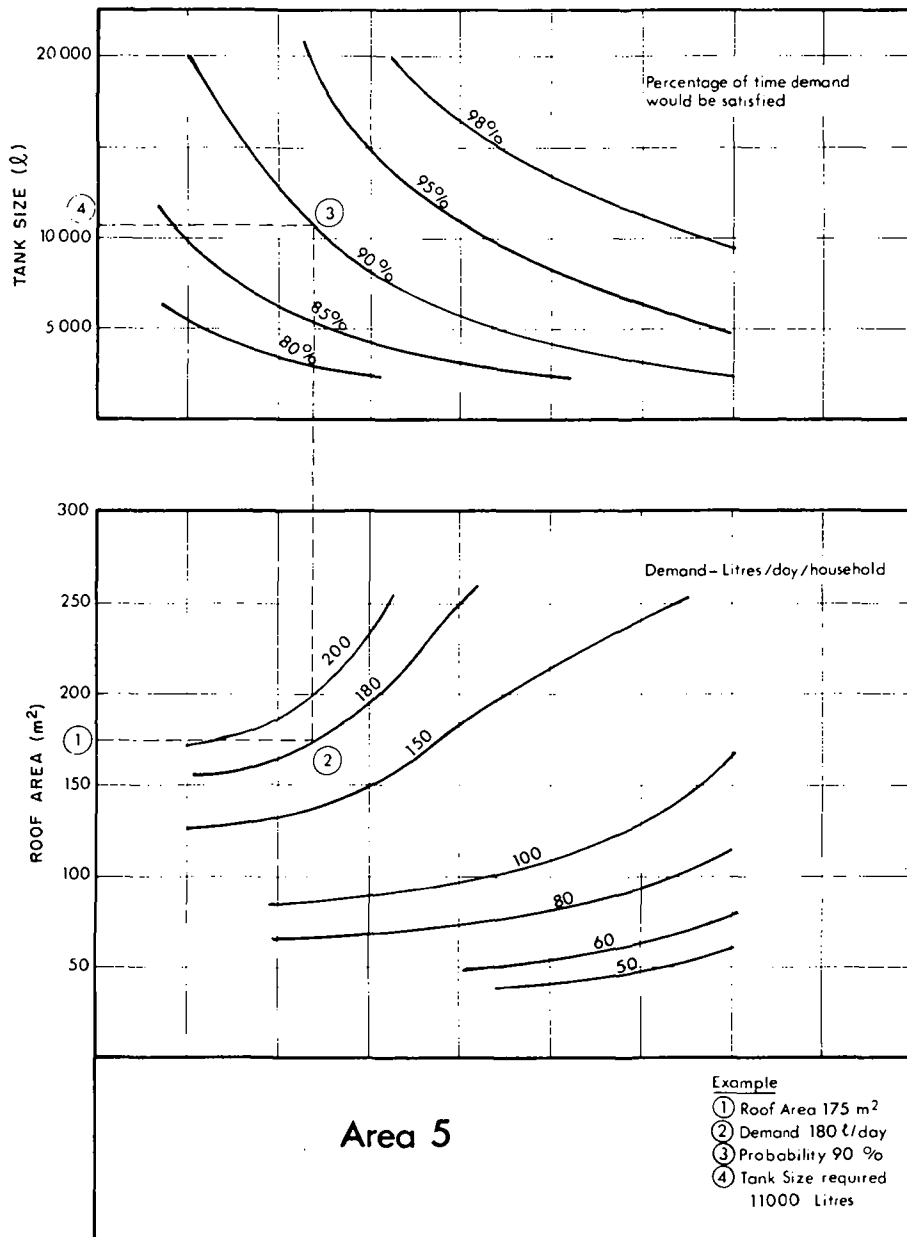

Figure 2. Raintank design nomograph

include installation, alterations to plumbing, gutters and downpipes; filtering; pressurising.

The raintank booklet was released to the public during a major publicity campaign directed mainly through the press. Daily papers and popular magazines ran feature articles on the benefits of raintank water. Manufacturers took advantage of the stimulated public interest, and some intense advertising campaigns were initiated. Rainwater tanks have been promoted via commercial advertising and government sponsored informational assistance. No financial assistance has been given despite tank manufacturers suggestions that the sales tax should be lifted.

It is difficult to gauge the success of the government initiated promotion campaign. There are some indicators which can be used to subjectively gauge the increased popularity which rain tanks appear to be attracting. The number of raintank manufacturers is increasing. Although no long-term data on tank sales are available, industry members claim that although sales of larger tanks (5000 litres and greater) has only slightly increased, sales of smaller tanks has dramatically increased over the last two to three years.

Rectangular tanks of up to about the 1500-liter size have become especially popular. These are quite portable, and are provided with a galvanized iron stand. Their rectangular construction makes them suitable for placement against house walls resulting in less space wasted than the older circular-style tank. The relatively small size of these tanks suggests that they are being predominantly used as a source of drinking water.

Figure 3 shows the relative magnitudes of rectangular tank sales since June 1979. It is interesting to note the seasonal nature of sales up until February 1981. Tank sales were typically high during the highest rainfall months of June, July, August and September. In anticipation of the release of the Government's raintank information brochure, tank manufacturers began intensive advertising in February 1981 which continued through March. During

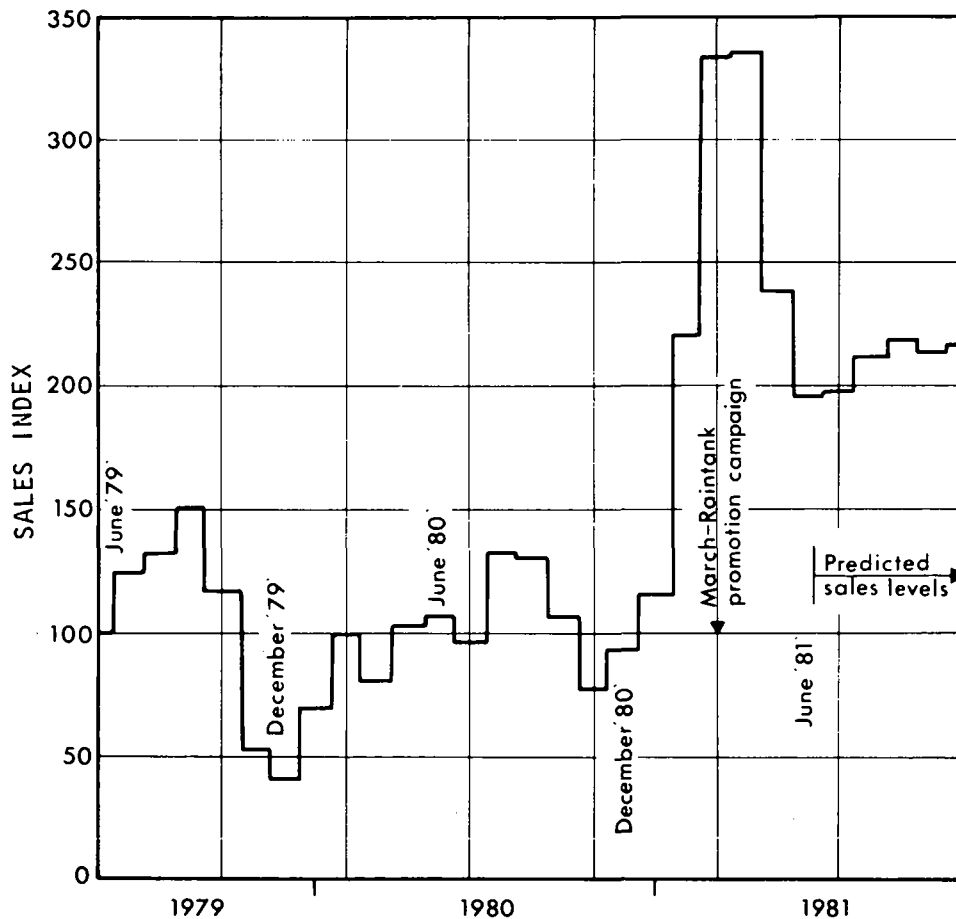

Figure 3. Raintank sales response

March, the Government publicity campaign was launched and copies of the information booklet made freely available. As can be seen from Figure 3, tank sales responded dramatically, rising to about 3½ times the June 1979 level. Industry predictions are that this sales rate will level off to slightly greater than twice the June 1979 level, at least until June 1982.

#### FIELD STUDY

The feasibility of rainwater supply systems can be assessed on a regional basis by the use of a computer simulation model. The input to the model is usually a long sequence of historical rainfall record often on a monthly, but sometimes daily, basis. This approach is well described by Jenkins and Pearson (1978).

Uncertainties exist for such a simulation model, and these relate to

1. The rainfall-runoff relationship
2. water consumption and consumer behavior
3. model lumping over the adopted time period (month, day).

Prior to an overall study into the feasibility of rainwater supplies for South Australia, a field study has been implemented to gain a better understanding of the physical processes which govern these systems. It is generally assumed that the connection between the gauged rainfall and the roof runoff process is perfect enough to either entirely ignore losses (Jenkins and Pearson 1978), or to subtract a small threshold loss (Perrens 1975). Similarly, there is a lack of understanding of consumption from a rainwater supply system. Most feasibility studies adopt a constant demand, although Perrens (1975) did assess the effect of rationing and called for a field study into this subject.

In the State of South Australia, there are presently ten locations (Fig. 4) where domestic rainwater systems are instrumented to record rainfall inflow and yield. The data is collected on a daily basis. This field study commenced in February 1981, and is programmed to be completed by July 1982.

The instrumentation is quite simple: a rain gauge sited close to the catchment area (roof), and a clear plastic graduated water level tube on the storage tank (or tanks). Other data include household and system characteristics, such as population, number and type of water using devices, outside house use, type of roof cladding, and roof and tank dimensions.

The purpose of the field study is twofold: (1) to examine the roof runoff process; and (2) to examine the daily variation of demand with the household characteristics (e.g., number of occupants, garden), and with the state of the storage (i.e., the extent of self rationing).

**ANALYSIS OF THE DATA.** Data from all ten locations is being analyzed to determine daily inflows and yields. Periods of missing records occur when the storage is overflowing or is dry, or when an observer is absent. These circumstances happen generally less than ten percent of the time and do not affect the results.

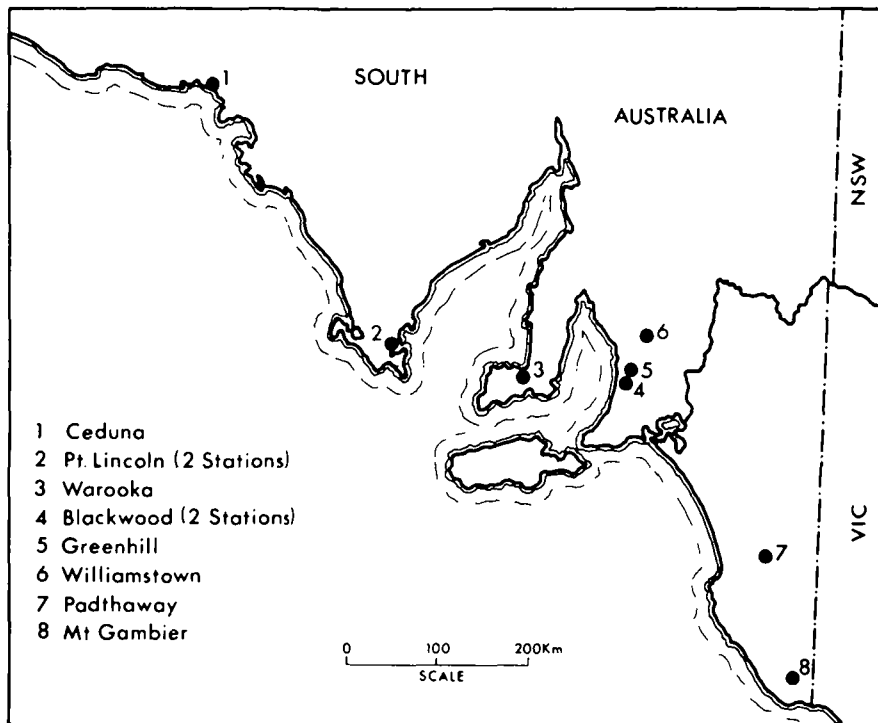

Figure 4. Field study area

1. **Roof Runoff.** At one of the two stations at Blackwood, the rain water is unused (i.e., the demand is zero throughout the study). This station can therefore be solely used to study the roof runoff process, by equating gauged rainfall with storage inflow. At the remaining nine stations, observers are cooperating to isolate rainfall events during periods of zero demand. This may occur overnight, or when the majority of the household occupants is absent for extended periods. Rainfall and storage level measurements are immediately required before and after the rainfall event. Some stations have multiple tank storage; therefore, it is possible to isolate one or more tanks and their respective roof catchments from the system to measure runoff. The data will be analyzed to determine a relationship between gauged rainfall and inflow to storage. Factors which will be considered include: roof material, rainfall volume and intensity, and wind and air temperature. Perhaps the simplest loss model would be the rational coefficient type.
2. **Storage Yield.** Once the roof runoff has been determined for the total record at each station, the yield can be derived from the daily change in storage. Since the observers are household members, it was originally thought that consumer behavior might be modified by an increase in awareness of the storage state. This potential drawback is countered by the argument that raintank users are already acutely aware of the need for water conservation, and the regular daily readings are not expected to significantly affect demand. Because demand is anticipated to vary significantly with storage state, the data will be analyzed to detect self rationing. A typical rationing curve may be anticipated to take the general form shown in Figure 5.

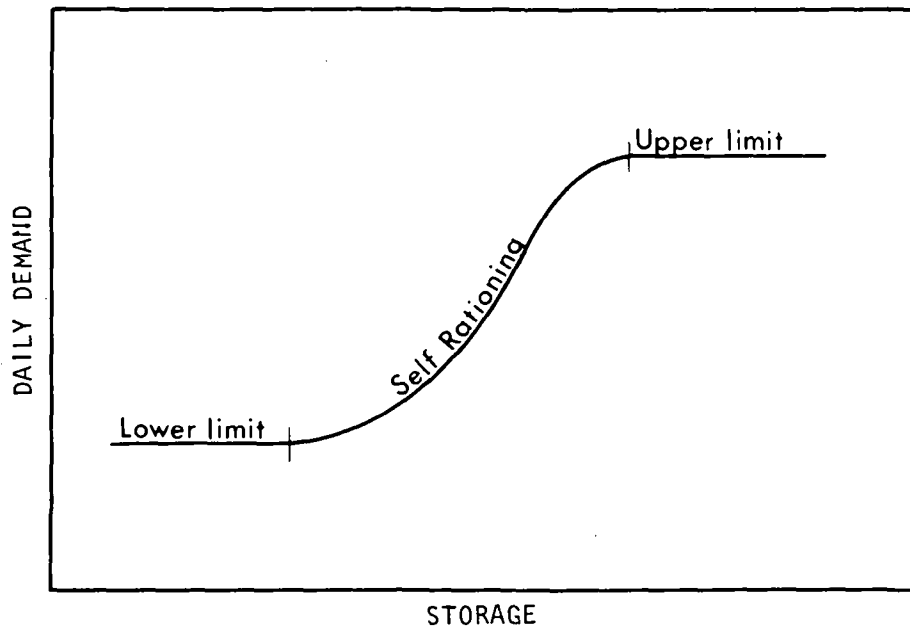

Figure 5. Hypothetical household demand-storage relationship

Figure 5 shows a demand-storage relationship which may apply to a particular household supply system. Here it is postulated that an awareness of available storage will have a dominant influence on consumption. The curve shows an upper and lower limit to demand, linked by a self rationing curve. Data from the study will indicate the existence and magnitude of this range for all nine operational stations. The sensitivity of system failure to rationing will have to be determined before a complex demand-storage relationship was included in a simulation model. Rationing has been dealt with by Perrens (1975) in a relatively simple manner, an approach that may be quite sufficient for a feasibility study.

While the demand-storage relationship in Figure 5 may be a unique feature of rainwater supply systems, it is further postulated that the total household demand function will contain variables such as number of occupants, technology (e.g., washing machines, dishwashers), gardening and income. Intercorrelations could exist, particularly between income and some of the other variables, although Clouser and Miller (1979) found no correlation between income and technology. The analysis of the data will permit the separate aspects of the total demand function to be investigated.

**SOME EARLY RESULTS.** It is not yet possible to provide results of the analysis of the data. However, some results are available from a quick review of the data and may serve to assist other rainwater feasibility studies.

Figure 6 shows a rainfall-runoff plot for the Blackwood No. 2 Station after 11 events. An event is taken to be an isolated burst of rainfall from which all roof runoff is observed to have ceased. The best fit straight line passing through the data from the origin has a slope (or runoff coefficient) of 0.8.

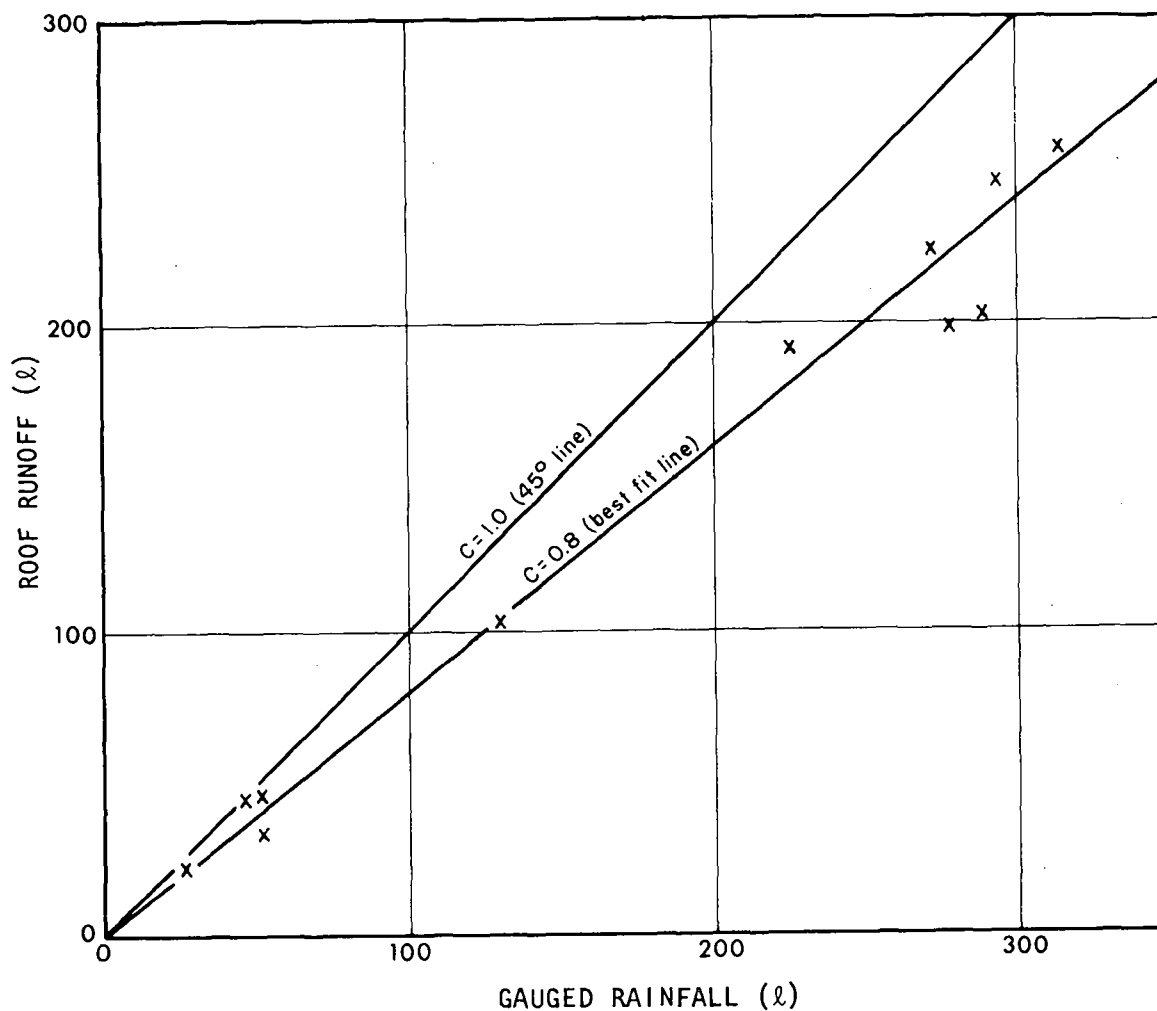

Figure 6. Rainfall-runoff events at Blackwood No. 2 Station

Feasibility studies of rainwater supply systems often assume domestic consumption levels comparable with reticulated systems of a developed urban area. This is an unfair comparison between two water supply systems: one system providing for a water conservationist, while the other providing for a user who has little or no incentive to manage his demand. Domestic water consumptions from reticulated systems in South Australia range from 400 litres per capita per day (lpcpd) in the higher rainfall (600 mm average annual rainfall) areas to an excess of 1 200 lpcpd in the arid areas (less than 200 mm average annual rainfall). For the rainwater supply systems surveyed, the consumptions all remained below 200 lpcpd during the below average rainfall autumn period of 1981. Typical average daily per capita consumptions were

Mount Gambier	145 litres
Greenhill	166 litres
Williamstown	102 litres.

At Greenhill, limited garden watering took place. At Williamstown, no garden watering took place, and the household technology is relatively unsophisticated.



## CONCLUSION

The intent of this paper has been to describe two very recent initiatives taken by the major water supply authority in the State of South Australia to encourage the use of rainwater supply systems for domestic application.

An easy to follow design brochure was released with considerable publicity, and has coincided with increasing public demand for an independent water supply of high quality. The brochure has been featured in all popular media coverage, and has been well sought after by the public. The sale of raintanks and fittings has sharply increased in the last year, although how much is the result of the brochure is difficult to assess.

The second initiative has been the South Australian Government's support of research into feasibility modelling of raintank supply systems. This research will follow the common practice of simulation modelling, using historical rainfall sequences as inputs to the system. The modelling is being preceded by a field study where physical measurements of the consumption and roof runoff processes are underway at selected locations throughout the state.

Such initiatives reflect a recognition by government that many individuals want alternative water supply systems, which offer self sufficiency and encourage conservation. A rainwater system has both of these advantages, and, in the case of South Australia, an improved quality of supply with rain water is seen as a major attraction.

## REFERENCES

- Clouser, R.L., and Miller, W.L. 1979. Household demand for water and policies to encourage conservation. Tech. Rep. No. 124, Water Resources Research Center, Purdue University, West Lafayette, Indiana.
- Engineering and Water Supply Department, South Australia. 1978. Metropolitan Adelaide water resources study. E.W.S. Lib. Ref. 77/42, South Australia.
- Engineering and Water Supply Department, South Australia. 1981. Rainwater tanks—Their selection, use and maintenance. South Australia.
- Jenkins, D., and Pearson, F. 1978. Feasibility of rainwater collection systems in California. Contrib. No. 173, California Water Resources Center, University of California.
- Perrens, S.J. 1975. Collection and storage strategies for domestic rainwater supply. In Hydrology Symposium, Inst. Engr., Australia, Armidale, pp. 168-172.

## RURAL RAINWATER CISTERN DESIGN IN INDONESIA

Winarto  
Yayasan Dian Desa  
Jl. Kaliurang Km. 7, Jurugsari  
Yogyakarta, INDONESIA

### INTRODUCTION

Water is difficult to obtain in some areas, such as the region of Gunung Kidul, which is located to the southeast of Yogyakarta in Java. The main source of water in this area is rainfall. During the dry season, villagers spend much time and labor fetching water over great distances for domestic use.

In Yogyakarta, several ponds serve as catchment basins for rainfall that accumulates during the rainy season. This water is used for drinking, cooking, bathing, washing and also for livestock watering. Some of these ponds, which dry up during the dry season, are several kilometres away from the people who use them. Under such conditions, it is common for local inhabitants to search for water several kilometres from their homes.

In the Gunung Kidul region, the water table is quite deep—up to 160 m (525 ft), thus making it difficult to hand dig wells to exploit the groundwater. And because of poor economic conditions, local people traditionally catch rain water in jugs as it flows from the roof.

It is especially true that Indonesians living in villages place great importance on the joy and value of working together. This belief in solidarity is quite widespread for, within the activities of day-to-day living, there is constant contact and cooperation between neighbors. From this point of view, we believe that there is much to gain if a rural program for constructing rain-water cisterns of ferrocement and bamboo cement is encouraged especially in developing countries.

### WATER CISTERN DESIGN

There are several advantages of using small-capacity water cisterns, such as the following:

1. The cistern can be built beside the house
2. Only a minimum area is needed
3. Self ownership is an incentive to take care of the cistern
4. The amount of water used can be controlled by the cistern owner
5. No special catchment area is needed; the house roof can be used
6. Quality control of the water is easier.

The cistern water should be mainly used for cooking and drinking purposes. Water for crop irrigation, bathing and washing would have to be supplied from larger-capacity cisterns or ponds and rivers.

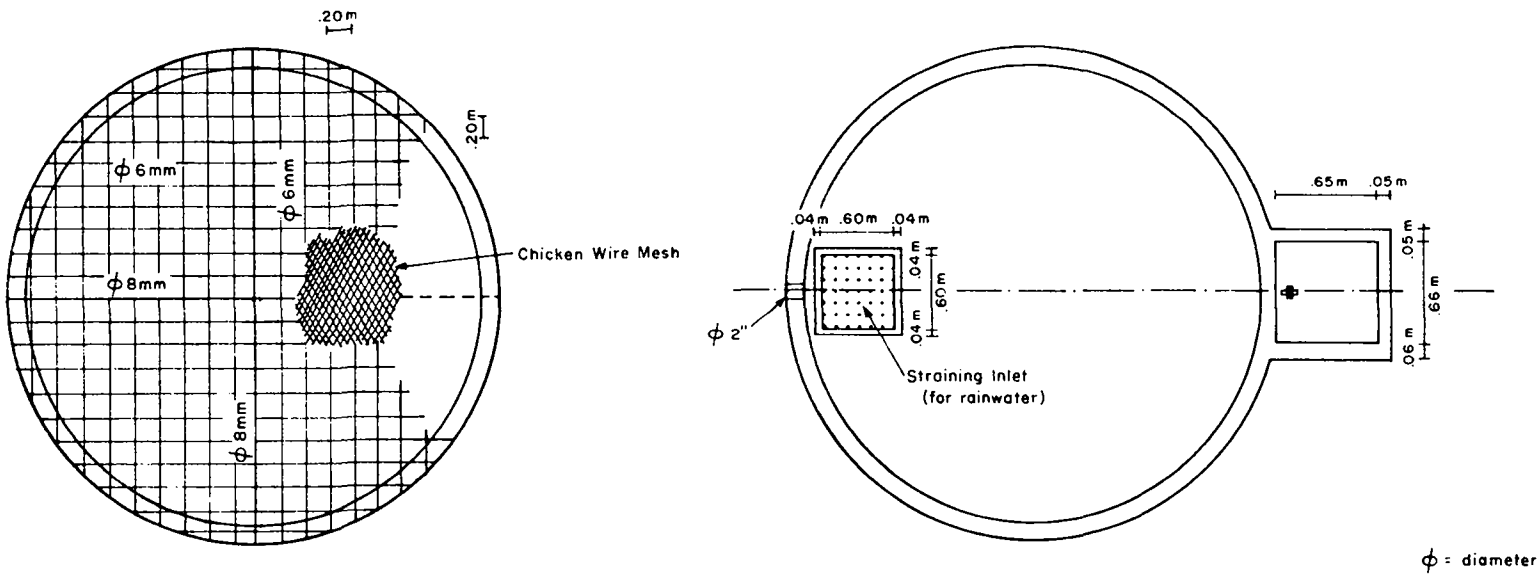
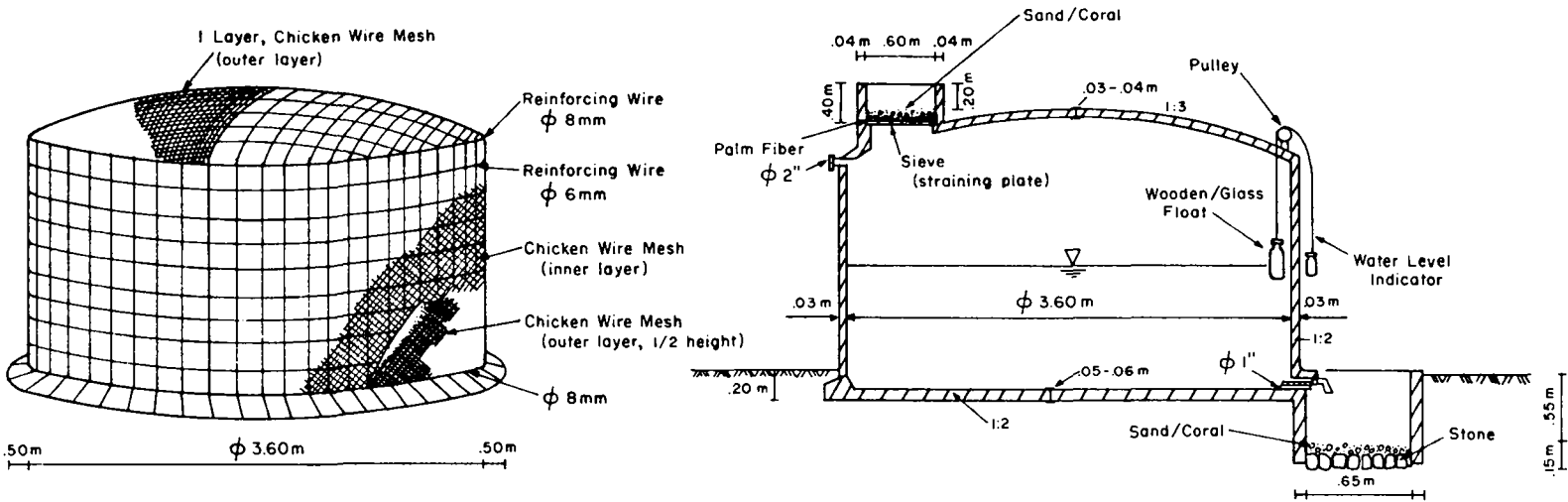

Figure 1. Structural design of a ferrocement or bamboo cement water cistern

DESIGN CRITERIA. The capacity of rainwater cisterns will depend on factors such as,

- Rainfall
- Daily water needs
- Number of family members
- Catchment area (roof surface)
- Length of wet and dry seasons.

All of these factors must be considered in the cistern design, but the two most important factors are available funds and the adequacy of the existing roof or catchment area.

According to our experience, the best structure of a water cistern is a cylindrical form of ferrocement or bamboo cement (Fig. 1). Components of a rainwater cistern should include the following.

1. Cistern base or foundation. The foundation can be of reinforced concrete, ferrocement or bamboo cement. The joint between the wall and the foundation can be fixed or a sliding base.
2. Cistern wall. Bending will occur if the joint between the wall and the base of the cistern is fixed. However, bending is negligible for small-capacity cisterns, and the only force that must be considered is hoop stress. Vertical reinforcement is used for ease in construction, to form a good shape and also as a safety factor. Woven bamboo matting, which is reinforced with wooden slats or bamboo poles, is wrapped around the steel or bamboo framework.
3. Cistern roof. The roof can be made of ferrocement, bamboo cement or of other suitable materials. There is no problem in calculating and constructing the slightly convex roof.
4. Filter. The filter is placed over the cistern opening and should be removable for cleaning.

FERROCEMENT CISTERN. The design of an  $18 \text{ m}^3$  ( $635.58 \text{ ft}^3$ ) ferrocement cistern is determined by the following:

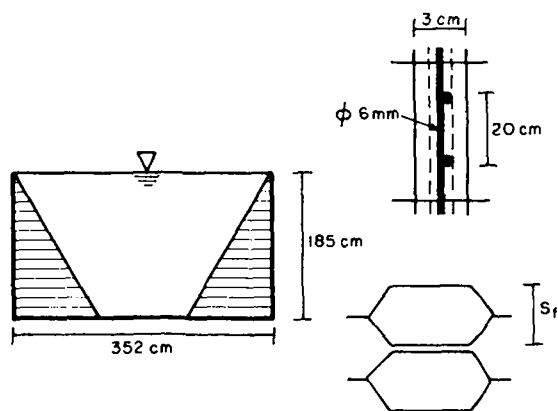

Figure 2. Ferrocement cistern

- $D$  = diameter = 3.52 m (11.55 ft)
- $H$  = height = 1.85 m (6.07 ft)
- $d$  = wall thickness = 3 cm (1.18 ft)
- $T$  = hoop force = 3 256 kg (1478.22 lb)
- $\sigma_{\mu}$  = mortar ultimate tension = 28  $\text{kg}/\text{cm}^2$  (397.896 psi)
- $d_1$  = diameter of chicken-wire mesh = 0.65 mm (0.026 in.)
- $s_f$  = distance of each wire at cross section = 1.50 cm (0.59 in.)
- $S_{f1}$  = total surface area of wire in contact with the mortar  $\div$  volume of composite
- $t$  = specimen thickness (effective thickness of mortar).

Thus,

$$S_{f1} = \frac{n d}{s_f t}$$

where

$$\begin{aligned} n &= \text{number of layers of chicken wire mesh} \\ t &= \text{effective thickness} \\ &= 3 \times 2 + 2 \times 0.65 = 7.30 \text{ mm (0.287 in.)}. \end{aligned}$$

Using the equation,

$$\sigma_{cr} = 140 S_{f1} + \sigma_{\mu} ,$$

compute two layers of chicken wire mesh as

$$S_{f1} = 0.95 ,$$

then

$$\sigma_{cr} = 37.322 \text{ kg/cm}^2 \text{ (530.896 psi).}$$

Ferrocement can withstand bending by using 1.25 as the safety factor (per 1-m height):

$$P_1 = 2 \text{ 181.76 kg (4805.64 lb).}$$

A 6 mm diameter steel rod (spaced at 20-cm center-to-center intervals) can withstand (per 1-m height):

$$P_2 = 1.413 \times 1300 = 1 \text{ 836.88 kg (4046 lb)}$$

$$P_1 + P_2 = 4 \text{ 018.66 kg (8851.67 lb)} > 3 \text{ 256 kg.}$$

Thus, to check bending or cracking and using  $n = 14 + \text{wall thickness} = 3 \text{ cm}$ , compute as

$$\sigma = \frac{P}{A_c + (n - i) A_{st}} < 11 \text{ kg/cm}^2$$

neglecting the chicken wire area,

$$\sigma = 10.22 \text{ kg/cm}^2 < 11 \text{ kg/cm}^2.$$

Thus, it can be seen that there is no difficulty in calculating and constructing ferrocement water cisterns.

**BAMBOO CEMENT CISTERN.** In constructing a bamboo cement water cistern, the procedure is the same. However, there is one problem: bonding between the bamboo and mortar is not very strong, although the tensile strength of bamboo is relatively good. The bamboo generally used for reinforcement in the Gunung Kidul region is called *Gigantocloa apus* (Bl.) ex-Schult. f. (Kurz). To overcome the bonding problem between the bamboo reinforcement and the mortar, the following procedure is used:

1. The bamboo reinforcement strips are alternately laid skin up and skin down
2. Horizontal bamboo strips are cross woven through parallel strips of the vertical bamboo strips every 3 cm (1.18 in.) at center-to-center intervals. Thus, this weaving pattern serves to strengthen the bond between the bamboo and the mortar.

The advantage of bamboo cement is that it is cheap and available locally. In addition, the villagers are quite skilled in working with bamboo. Although we have always constructed 10 m<sup>3</sup> bamboo cement water cisterns, which are still

in good condition, we have placed a 4.50 m<sup>3</sup> capacity limit on water cisterns.

#### CONCLUSION

The low cost and ease of constructing ferrocement and bamboo cement water cisterns, in comparison to other materials, are reasons both types fulfill the basic needs of rural people in Indonesia.

## RAINWATER COLLECTORS FOR VILLAGES IN WEST JAVA, INDONESIA

Ron van Kerkvoorden, Engineer  
Rural Water Supply West Java Project 0-9(a)  
P.O. Box 59  
Bandung, INDONESIA

### INTRODUCTION

The West Java Rural Water Supply Project is jointly sponsored by the governments of Indonesia and The Netherlands. The International Water Supply Consultants IWACO B.V. was appointed to provide consultant services, part of which included the development of simple techniques for water supply systems and the transfer of this information to the rural population so the villagers could construct their own rainwater collection systems.

This paper presents the use of local building materials, the value of close cooperation of local authorities and the rural population and how people can build their own drinking-water system.

### PROJECT SCOPE

In West Java, critical drinking water supply conditions exist in the northern coastal plain (Fig. 1). In this coastal plain, an estimated 2 million people live in areas without reliable natural water resources. These areas are mainly located along the sea coast where the shallow groundwater is generally brackish due to salt water intrusion.

For this area, the collection and storage of rain water is the only possible solution having a chance of widespread use that can be almost immediately implemented because the planning and construction are relatively simple. And an added benefit is that the people will participate in a project giving them more water for their use.

Since the storage of rain water is relatively expensive, only water for human consumption (drinking and cooking) will be supplied, for which 5 l/capita/day (l/cd) is considered a minimum quantity. The source of additional water for washing and bathing will be of a lower water quality standard from available surface water (e.g., irrigation water) or from slightly brackish shallow groundwater. An additional water storage source might be provided by storage ponds when these sources cannot be relied upon during that part of the year when the irrigation water supply may be interrupted for some time for maintenance work on the canals or because of water shortage.

### TECHNICAL PROGRAM

The technical program of the West Java Rural Water Supply Project includes two development activities:

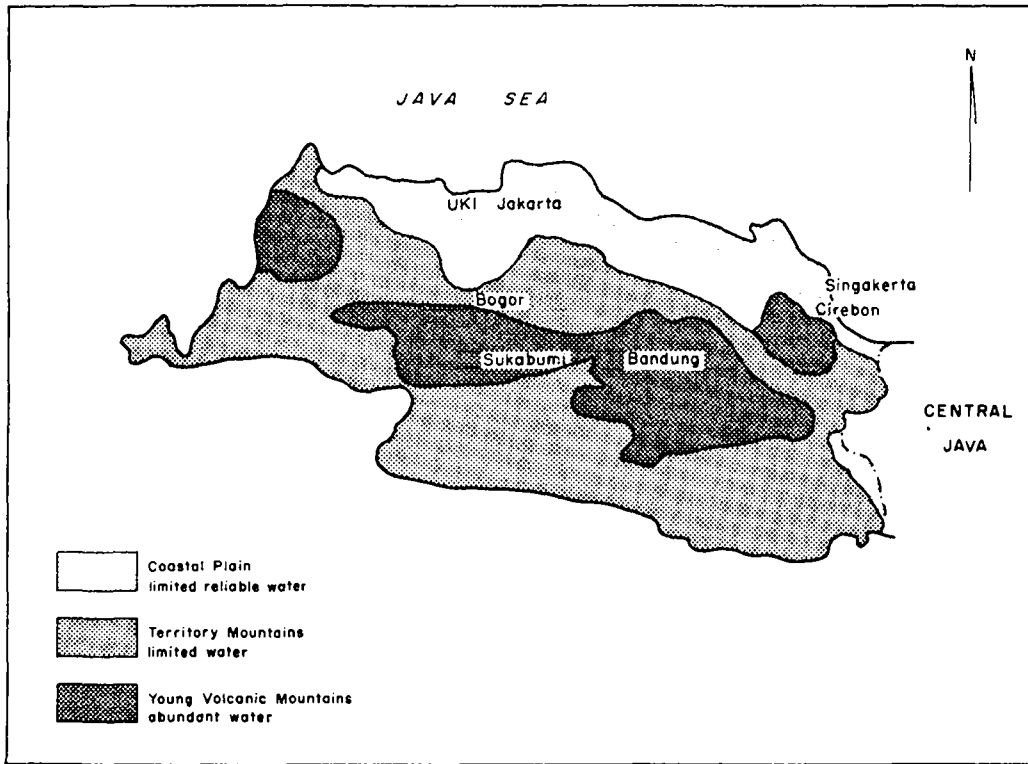

Figure 1. Pilot project area in desa Singakerta, kabupaten Indramayu

1. A high-quality, rainwater collector (RWC) for at least four households that would meet government program standards
2. A somewhat lower quality RWC for single household use at the lowest possible cost to encourage self help.

For the coastal plain town of Singakerta, a high-quality RWC with a 10 m<sup>3</sup> storage capacity could serve four households. Until the present time, ferrocement and brick RWC's were designed and constructed.

Regarding item 2, small rainwater collectors with a 2.5-m<sup>3</sup>/capacity for single households may be constructed of the following materials:

- Brick\*
- Clay with cement\* (or other) lining
- Corrugated metal sheets
- Ferrocement without reinforcement\*
- Bamboo cement\* (bamboo reinforcement)
- Ijuk cement\* (palm fibre reinforcement)
- Sisal Cement\* (sisal reinforcement)
- Ferrocement\* (wire-mesh reinforcement)
- Rubber pillow tanks
- Fiberglass (factory made)

Until now, prototype RWC's were constructed of the materials marked with an asterix (\*). Because the construction work in this particular project is



aimed at an essentially self-help program with locally available materials, construction materials do not include corrugated metal sheets, rubber "pillow" tanks and fiberglass. These materials are considered as foreign to desa populations in addition to being very expensive.

#### PILOT PROJECT RAINWATER COLLECTORS

In 1978, IWACO started a pilot project for rainwater collectors in desa Singakerta in the kabupaten (part of a province) Indramayu to test and evaluate the possibilities of low-cost rainwater collection systems. Various collectors were constructed of the materials listed on the preceding page. From experience and after testing various materials during the pilot project, ferrocement seemed to be the best suited material for the construction of rainwater collectors. After being trained in a simple and practical course, ferrocement collectors can be built by the local rural population from the necessary materials such as, cement, sand and chicken-wire mesh, which are available in almost every rural area.

#### FERROCEMENT RAINWATER COLLECTOR MANUAL

Because of the interest generated by different local governments and authorities in the properties of ferrocement—in general, as well as the special use of ferrocement for a water supply system—in particular, a manual for rain collectors of ferrocement with a 10 m<sup>3</sup> storage capacity was prepared for the West Java Rural Water Supply Project (App. A). The manual includes all the experiences from the pilot project.

The text of the manual is illustrated with pictures and drawings of the rainwater collectors to make it easily understandable for users of the manual. The manual was specifically prepared for the Indonesian rural situation and is written in the Indonesian language.<sup>1</sup>

After the manual was published and distributed, it was apparent that it met and satisfied many important needs for rural water supply systems. Rural medical doctors of the northern coastal plain have asked for more information, and they have asked the West Java Rural Water Supply Project to send ferrocement experts to discuss and recommend the manual to the rural population in their districts and, if possible, to construct a rainwater collector as an example.

Because of this kind of enthusiasm and interest in rainwater collectors, the idea arose to provide practical courses and to issue a manual on how to build ferrocement rainwater collectors. In addition, the West Java Rural Water Supply Project provides training courses for the operation and maintenance of water supply systems in general.

---

<sup>1</sup>An English language issue will be available for the ICORWCS 1982 session.

## FERROCEMENT RAINWATER COLLECTOR COURSE

Practical courses on the construction of 10-m<sup>3</sup> volume ferrocement rainwater collectors will be given to sanitarians, health controllers, district- and provincial level member of Public Works and interested people who live in the district where the course will be held. The course will be open to about 25 people per course of 12-day duration. One day will be used to explain the general theory of the properties of ferrocement and the theory of the rainwater collector manual. This is followed by actual construction of collectors. During one course, four collectors are normally built, step by step according to the manual by six people per collector.

The final results of almost every practical course are amazing—especially for the self confidence of those who have successfully constructed a collector for the course. Each participant of the course is presented with a certificate signed by a medical doctor who represents the Department of Health which is responsible for the rural water supply.

The course is conducted by an Indonesian or foreign ferrocement expert, who speak fluent Indonesian, of the West Java Rural Water Supply Project. During the entire course, the expert is available by those participating in the course for advice, assistance and general knowledge. The supervisor of such a course is the head of the Department of Hygiene and Sanitation of the province and he periodically visits the class and inspects what is being done to see that everything is running well.

## IMPLEMENTATION

Large-scale implementation of rainwater collector construction is based on two possibilities:

1. As part of a government program, such in Inpres
2. By means of self-help participation by the people.

The first possibility would impose the following requirements:

- Strong, reliable and durable construction
- Community use intent (a condition set by the Department of Health authorities that one unit serve at least four households)
- Construction costs that are not higher than necessary, although this is not of prime importance.

The second possibility would impose somewhat different requirements, such as,

- Inexpensive as possible construction costs (affordable by even the poorer families), locally available materials and simple construction methods
- Units available for individual households (but not necessarily so)
- Less stringent requirements for strength and reliability (based on the assumption and experience that individual owners will take good care of his own work and investment).

A parallel investigation with the technical study should be made to learn aspects such as, the financial ability of people to contribute to self-help

programs, the involvement of the people, organization of these programs and the user acceptability of rain water for domestic use.

#### COURSE FINANCING

The costs for materials and accommodations for course members will be paid out of a budget provided by the district of the rural doctor. The materials necessary for the course and purchased before the course starts is normally paid for by the head of Hygiene and Sanitation at the district level in cooperation of the ferrocement expert of the West Java Rural Water Supply Project.

The following costs will be carried out by the West Java Rural Water Supply Project:

- Services of the ferrocement expert and his three assistants
- Transport from the Bandung project office to the place where the course will be held
- Printing and providing course manuals.

#### CONCLUSIONS

After participating in different courses given in the kabupatens of Indramayu, Cirebon, Tasikmalaya, Serang, Bekasi and Karawang, the people of these rural areas have expressed great satisfaction and enthusiasm for this kind of self-help program. This has also been confirmed by the Department of Health after investigations and evaluations of those districts where practical courses had been held by West Java Rural Water Supply Project personnel. Under the direction of a sanitarian ferrocement expert of their own district, people have been building their own rainwater collectors. This has resulted in great progress toward and improvement in public health. Because ferrocement has proved to be strong and good enough for the construction of these collectors and the self-help program has proved its value and worth to the Department of Public Works, it means that now, almost automatically, money from the central government budget will be allocated for self-help programs.

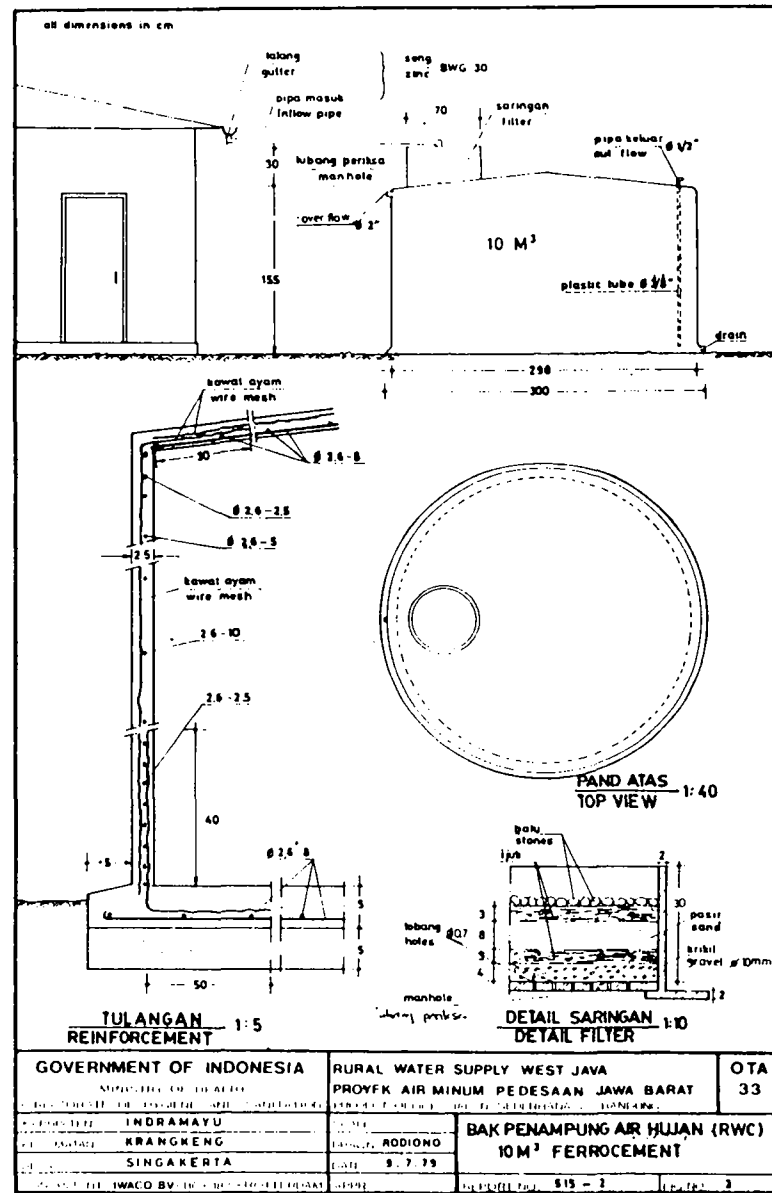
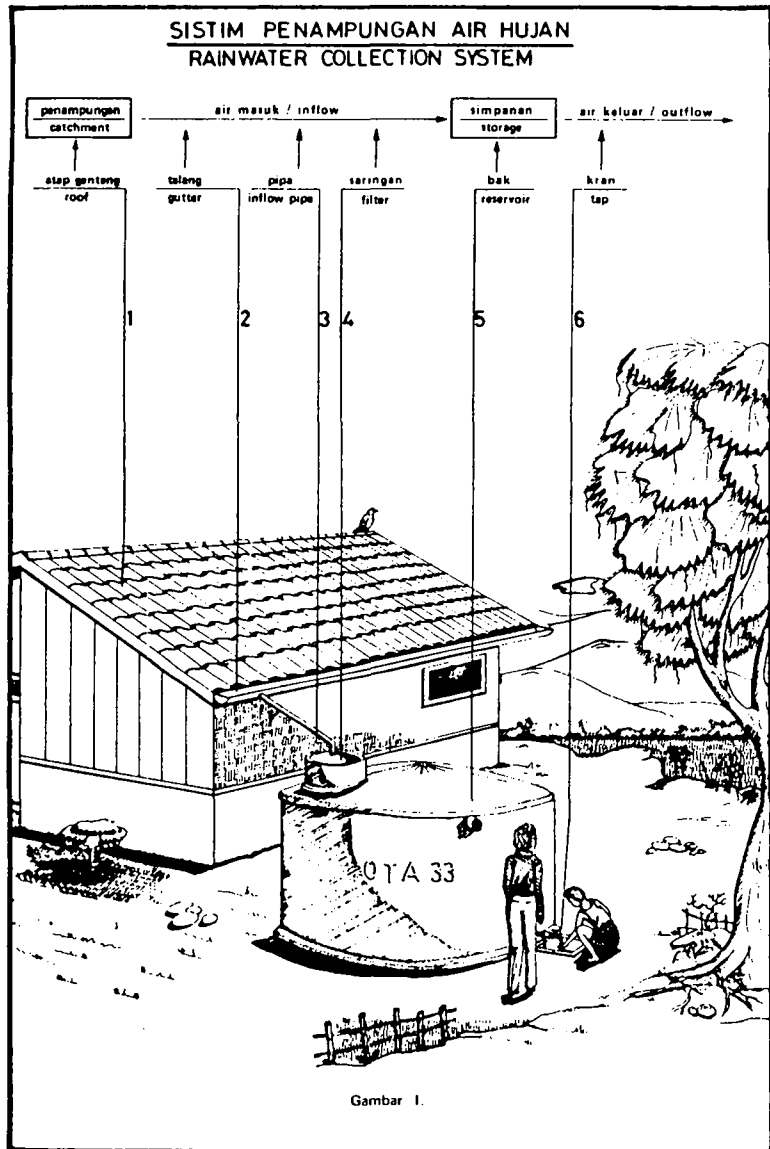



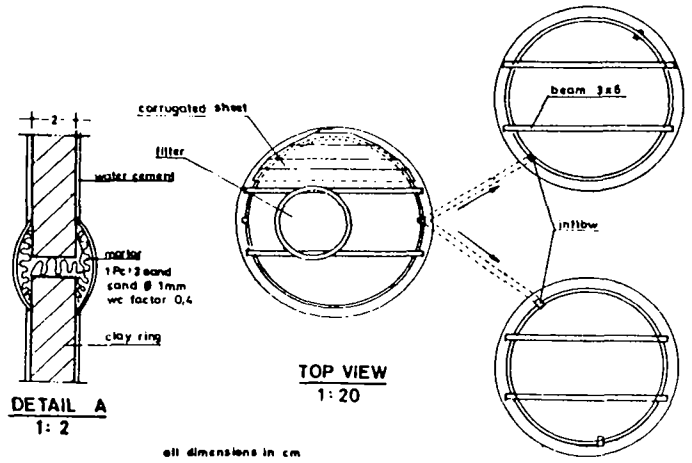
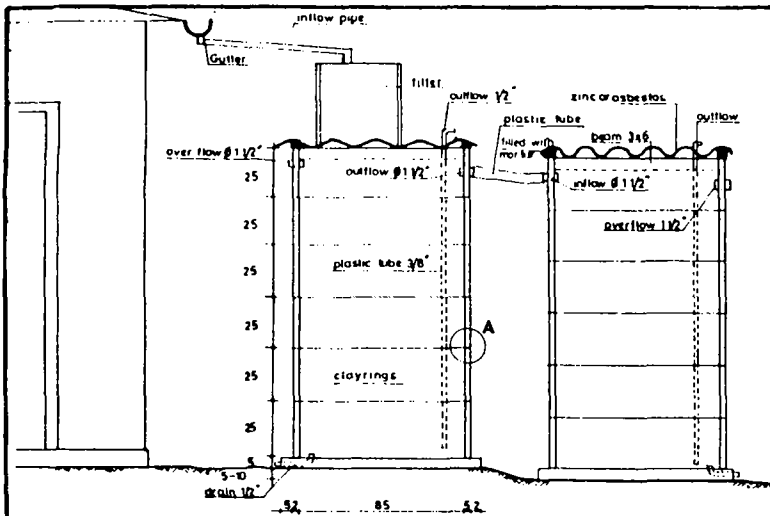

GOVERNMENT OF INDONESIA MINISTRY OF HEALTH DIREKTORAT BINA KESEHATAN DAN SANITASI	RURAL WATER SUPPLY WEST JAVA PROYEK AIR MINUM PEDESAAN JAWA BARAT	OTA 33
LOKASI: INDRAMAYU	TAHAP: 1:2 N 1:20	CLAY RWC 2.5 M <sup>3</sup>
PELAKSANA: KRANGKENG	DESAIN: RODIONO	
LOKASI: SINGAKERTA	TARIK: 13.7.79	
DOKUMEN: IWACO BY. (RUK. H) - (RUK. T) (INDRAMAYU)		NO. RUK. H: 515 - 2

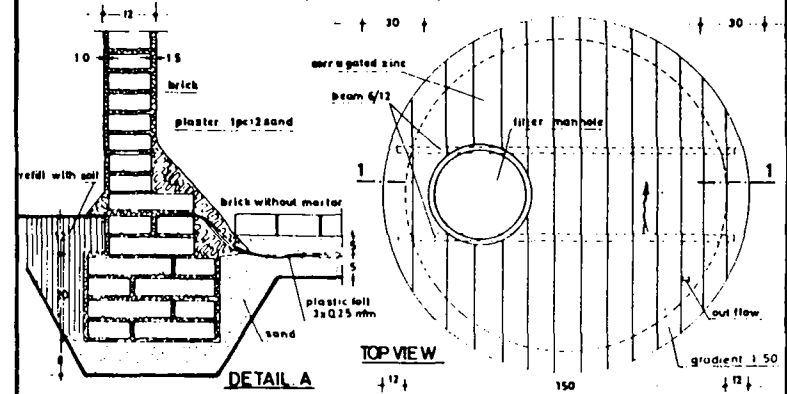
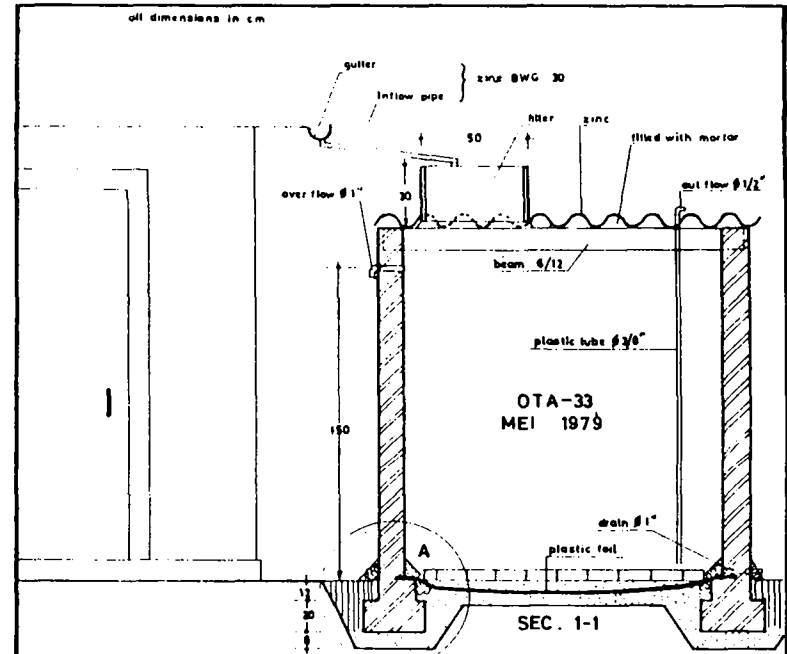

GOVERNMENT OF INDONESIA MINISTRY OF HEALTH DIREKTORAT BINA KESEHATAN DAN SANITASI	RURAL WATER SUPPLY WEST JAVA PROYEK AIR MINUM PEDESAAN JAWA BARAT	OTA 33
LOKASI: INDRAMAYU	TAHAP: 1:20 N 1:20	RAIN WATER COLLECTOR 2.5 M BRICKWORK
PELAKSANA: KRANGKENG	DESAIN: RODIONO	
LOKASI: SINGAKERTA	TARIK: 13.7.79	
DOKUMEN: IWACO BY. (RUK. H) - (RUK. T) (INDRAMAYU)		NO. RUK. H: 515 - 2

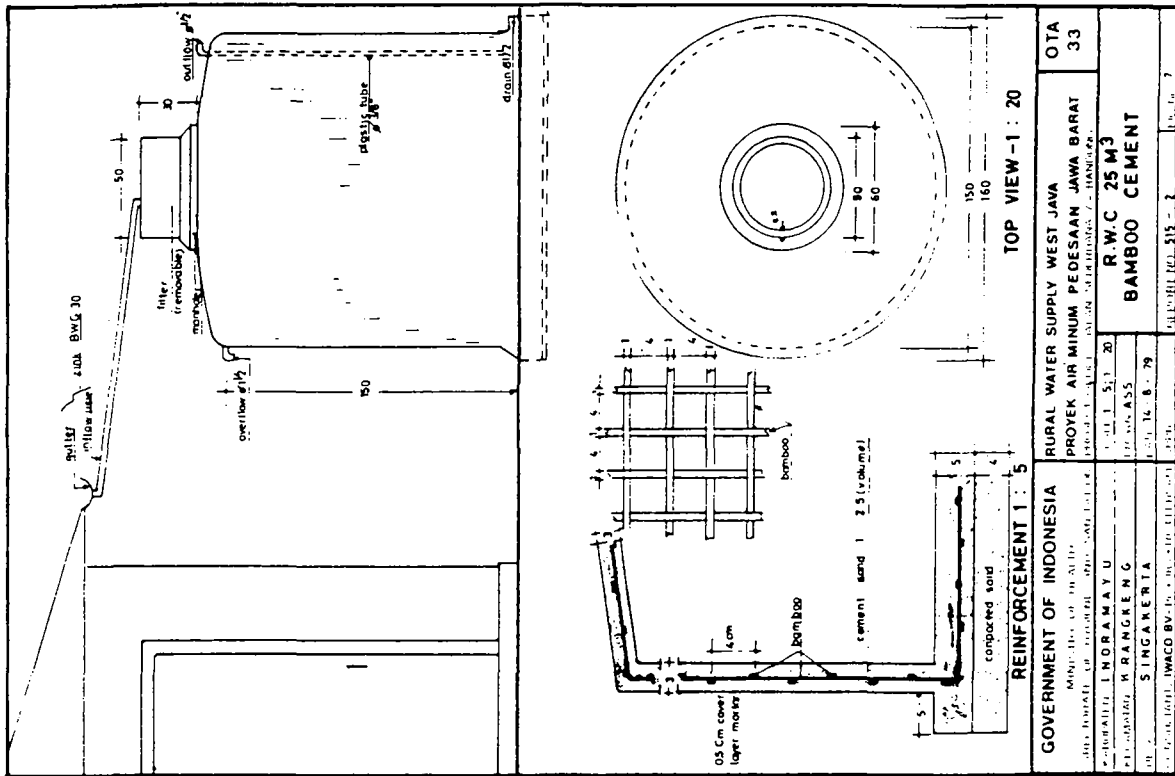

RURAL WATER SUPPLY WEST JAVA PROYEK AIR MINUM PEDESAAN JAWA BARAT		OTA 33
GOVERNMENT OF INDONESIA MINISTRY OF PUBLIC WORKS AND INFRASTRUCTURE DEVELOPMENT		
INDONESIA JAWA BARAT KABUPATEN INDRAMAYU Kec. KRANGKENG Desa SINGKERTA	TAHUN 1979 NO. SKED. 14. B. 79	
R.W.C 25 M <sup>3</sup> BAMBOO CEMENT		
RUMAH SAKIT 515-2		1/10/79

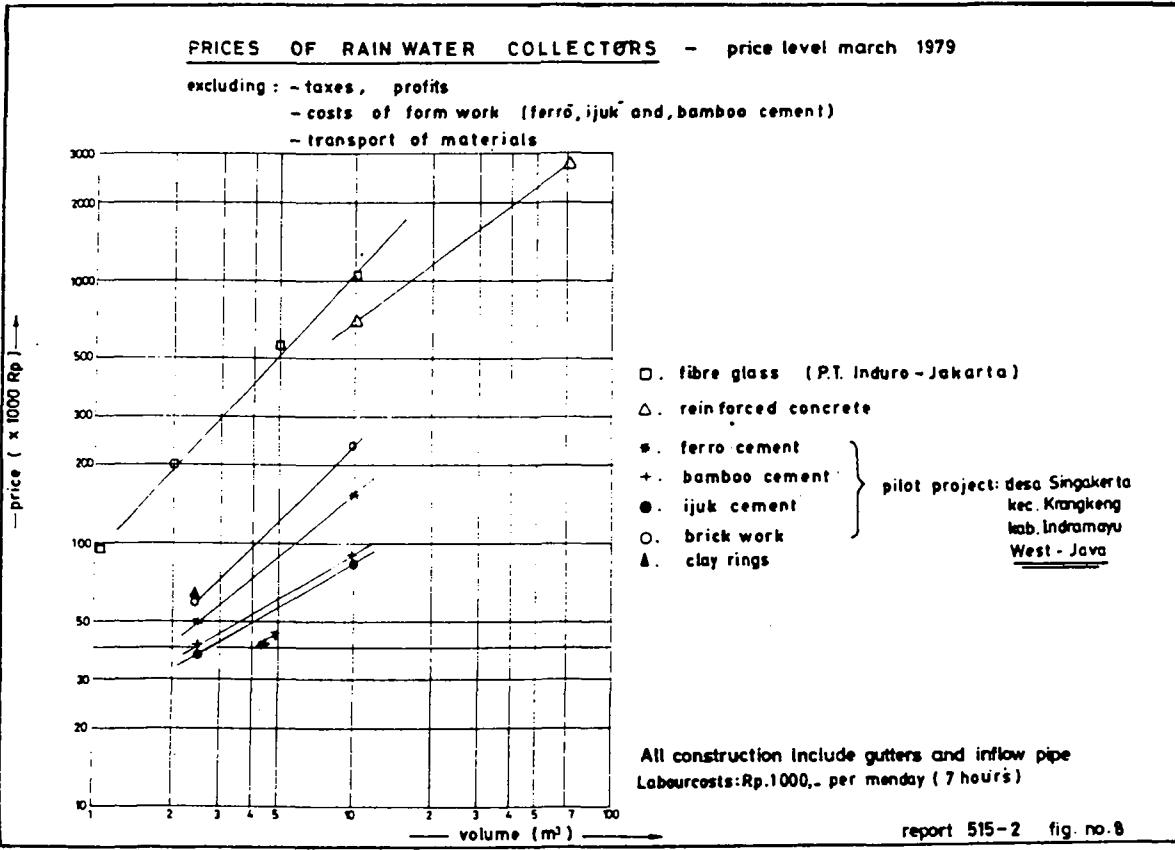

## EFFECT OF RATIONING ON RELIABILITY OF DOMESTIC RAINWATER SYSTEMS

S.J. Perrens, Head  
Resource Engineering Department  
University of New England  
Armidale, New South Wales, 2351 AUSTRALIA

## INTRODUCTION

In a companion paper, Perrens (1982) presented the elements of a simulation model which has been used to study the main design parameters of rainwater supply systems at four locations in Australia. For that study, the model was run assuming that no rationing policy was adopted when supplies were low. The results showed, however, that for all but the areas of subtropical rainfall with a mean annual greater than 1500 m, inadequate supply would be available from all the roof areas on a typical farm or "station" to allow a reasonable standard of living for a family of four people. Under these circumstances, two strategies are commonly employed:

1. Overall reduction in the demand for rain water either by lowering expectations or by seeking an alternative source of water to meet an element of the demand, for the use of water from a farm dam for toilet flushing or, with minor treatment, for clothes washing
2. Acceptance of a short-term reduction in demand by accepting a rationing policy which will increase the reliability of the supply for a given demand or, alternatively, allow increased demand for the same reliability.

The problem of allocating the rainwater resource given certain practical constraints on the physical elements of the system (storage size and catchment area) is one which regularly faces many Australian homesteads. Rationing may therefore be seen as an alternative to increasing the size of the physical components of the system. To make rational decisions about rationing, the user will need to know:

1. The rationing policy to apply (duration of rationing and reduction of demand)
2. The effect of a particular policy on the reliability of the supply
3. The frequency with which rationing will be imposed under a particular policy.

This paper presents some preliminary analysis of these factors which have received very little attention to date.

Body (1968*a*, *b*) studied a range of rainwater supply systems in Australia and examined the effect of rationing policy on the reliability of supply. His work was never completed, however, and the results have not been made generally available. Body adopted more complex rationing rules than those used in this study and examined a three-stage rule requiring successive reductions of demand to 75, 50 and 25% of full demand when particular storage levels were reached. The study took the percentage of time that rationing could be accepted as one of the criteria for design and examined the probability of



achieving this. The study also examined the variability of rationing with particular historic sequences of rainfall.

Like many engineering design tasks, the analysis can be made as complex as desired. The main factor requiring judgement is the appropriate level of sophistication required for the task in hand. In this paper, which is based on a study primarily aimed at domestic rainwater systems, one simple rationing rule has been examined.

#### INVESTIGATION

A general simulation model was developed to analyze the behaviour of a simple rainwater supply system having an impermeable catchment feeding into an enclosed storage from which a specified demand was met. Four locations in New South Wales were analyzed for this study because they represented the major climatic zones in the state. Table 1 gives the major climatic and geographic features of the locations studied.

TABLE 1. CLIMATIC CHARACTERISTICS OF LOCATIONS STUDIED,  
NEW SOUTH WALES, AUSTRALIA

	Armidale	Coffs Harbour	Griffith	Sydney
General Climate	Temperate Highland	Subtropical Coast	Hot Arid	Temperate Coast
Annual Rainfall	Mild summer dominance	Summer dominance	No seasonal dominance	No seasonal dominance
Latitude (S)	30° 31'	30° 19'	34° 16'	33° 52'
Altitude (m)	980	2.7	131	92
Mean annual rainfall (mm)	795	1759	391	1216
Median annual rainfall (mm)	771	1614	382	1160
Years of record	110	60	60	130
Rain days/yr	110	147	76	139

The simulation model used was capable of being used for either daily or monthly rainfall data. For each time period, a simple water budget was kept that included:

1. Inflow, if any, from a specified catchment area after allowing for a small initial evaporative loss
2. Storage contents determination
3. Overflow, if storage was full
4. Rationing decisions, if supply less than predetermined level
5. Resupply decision, if storage empty
6. Water allocation to satisfy demand, if possible.

The rationing policy adopted for this study was a simple three-stage rule, as follows:

1. Reduce demand to 90% when less than 30 days normal supply remains
2. Reduce demand to 75% when less than 20 days normal supply remains
3. Reduce demand to 60% when less than 10 days normal supply remains.

When the storage was emptied and unable to meet the rationed demand, a small replenishment amounting to a 10-day supply was allowed and the system was considered to have "failed". It should be noted that in this case "failure" constitutes the inability to supply any water rather than the inability to supply the full demand. Performance statistics for a range of relative sizes of collection area and storage volume were analyzed in terms of reliability of supply, the effect of rationing and the proportion of time that rationing was imposed.

## RESULTS AND DISCUSSION

To make the results of the computer simulation applicable to rainwater supply systems of any physical size, they are best expressed in terms of two fundamental parameters:

- Demand from the system  $D$  (ℓ/day)
- Average annual rainfall  $R$  (mm).

Once these two parameters are determined they define

- The basic catchment area  $A$  ( $m^2$ ), as  $A = 365 D/R$
- The storage size expressed in terms of days of full demand.

The remaining parameters which are used to measure the performance of the system are

- The reliability of "failure" rate of the system
- The proportion of the time that rationing must be imposed.

Figure 1 shows a typical set of results for comparing the effect of rationing on the reliability of rainwater systems in one of the locations studied, Coffs Harbour. It can be readily seen that even a modest rationing rule, such as that adopted for this study, can lead to significant improvement in supply. In practice the effects of rationing may be used in a number of ways:

1. Reduce required storage size
2. Reduce required catchment
3. Improve reliability of supply.

An example will illustrate these options well. Take the case of a rainwater system which has the following parameters (assuming no rationing is adopted):

$$\begin{aligned} \text{Demand} &= 1000 \text{ ℓ/day} \\ \text{Area} &= 1.5 \text{ times basic} \\ &= 311 \text{ m}^2 \end{aligned}$$

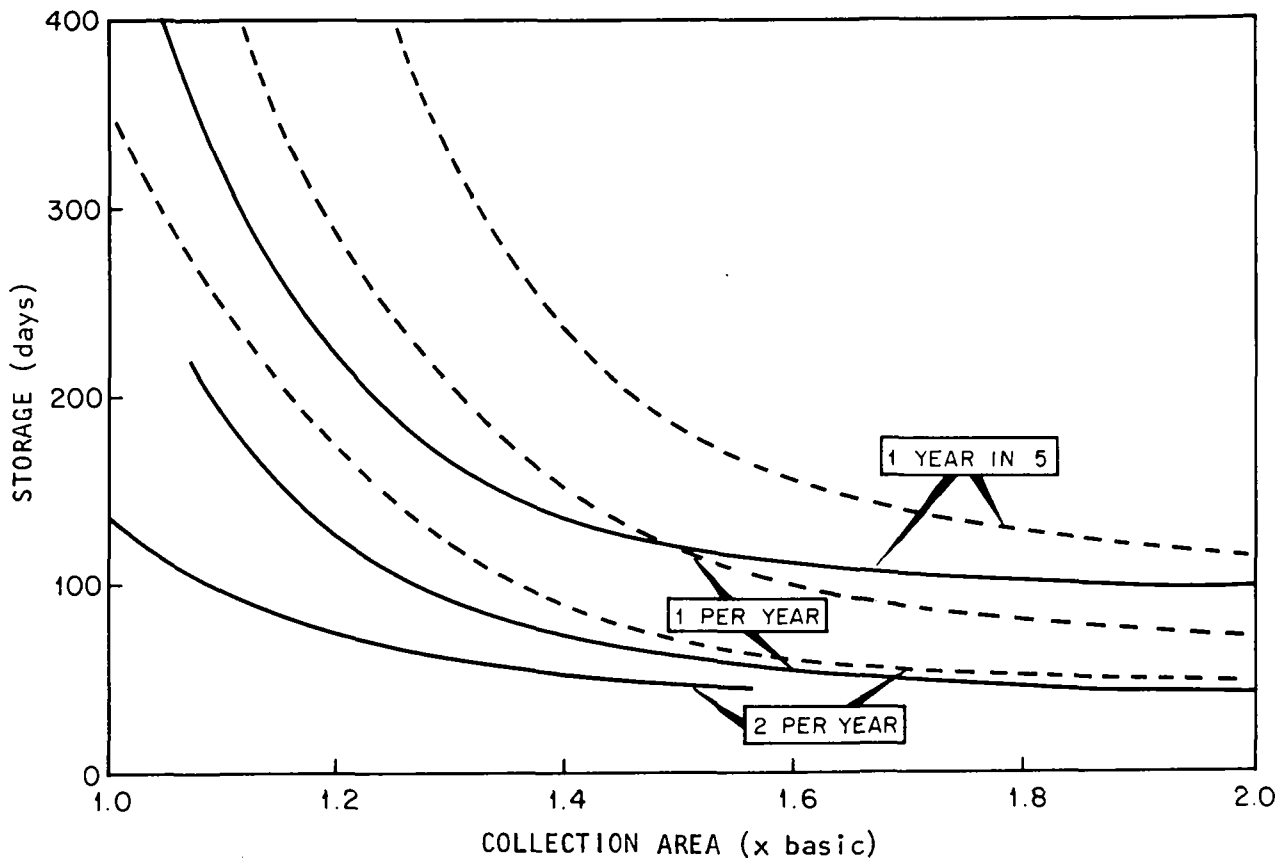

Figure 1. Effect of rationing on required catchment area and storage volume at different reliabilities for Coffs Harbour

Storage = 120 demand days  
 = 120 m<sup>3</sup>

Acceptable Failure Rate = 1/yr

If rationing is adopted, the following alternatives may be utilized:

1. Improve reliability to 1/5 years with all other parameters remaining the same, i.e., decrease total replenishment of water over 5 years by 40,000 l (2.2% of total consumed)
2. Decrease the required catchment to 1.2 x basic (249 m<sup>2</sup> = 20% decrease)
3. Decrease required storage to 60 demand days (60 m<sup>3</sup> = 50% decrease)
4. Increase demand which may be made to a value that just satisfies the storage and area parameters defined by the curve for a failure of 1/yr with rationing. In this case, the full demand can be increased to 1200 l/day (1.25 x basic area, 100 days storage).

This last option implies that rationing will have to be accepted on some occasions. The data in Figure 5, which will be discussed later, shows that for a failure rate of 1/yr, rationing may be expected for an average of 3 times per year for a catchment area which is 1.25 times the basic. Therefore, if the rationing rule is assumed to apply for the full 30 days, then the net yield from the system for a full year would be 1125 l/day after allowance for rationing. Thus, although the rationing policy would require the average daily de-

mand to drop to 900  $\ell$ /day in a month requiring rationing, the net yield from the system would in fact be increased by 12.5% for the same degree of reliability.

Clearly, the possible options which may be pursued are endless. However, data such as that presented in Figure 1 gives a rational basis for comparison of alternatives and the trade-offs which can be made in designing a new system, upgrading an existing system or comparing alternative sources of supply.

Figure 1 related specifically to Coffs Harbour. In Figures 2 and 3 generalized data are presented for the locations studied for failure rates of 1/yr and 1/5 yr. A comparison of the data in these figures with the data presented by Perrens (1982) for the unrationed case will enable the choices illustrated above to be made for other localities.

It is interesting to note, however, that for the case of an accepted failure rate of 1/yr, the curve for Griffith lies below that for Sydney while for a failure of 1/5 yr it is above that for Sydney. Also, for the unrationed case, the order of the curves is reversed. Clearly, rationing has a proportionately greater effect in Griffith than in Sydney at this reliability. The explanation for this has not been fully explored but may well lie in the greater variability of rainfall between years at Griffith. Both centers have almost no seasonal dominance of average rainfall. However, for Griffith, the

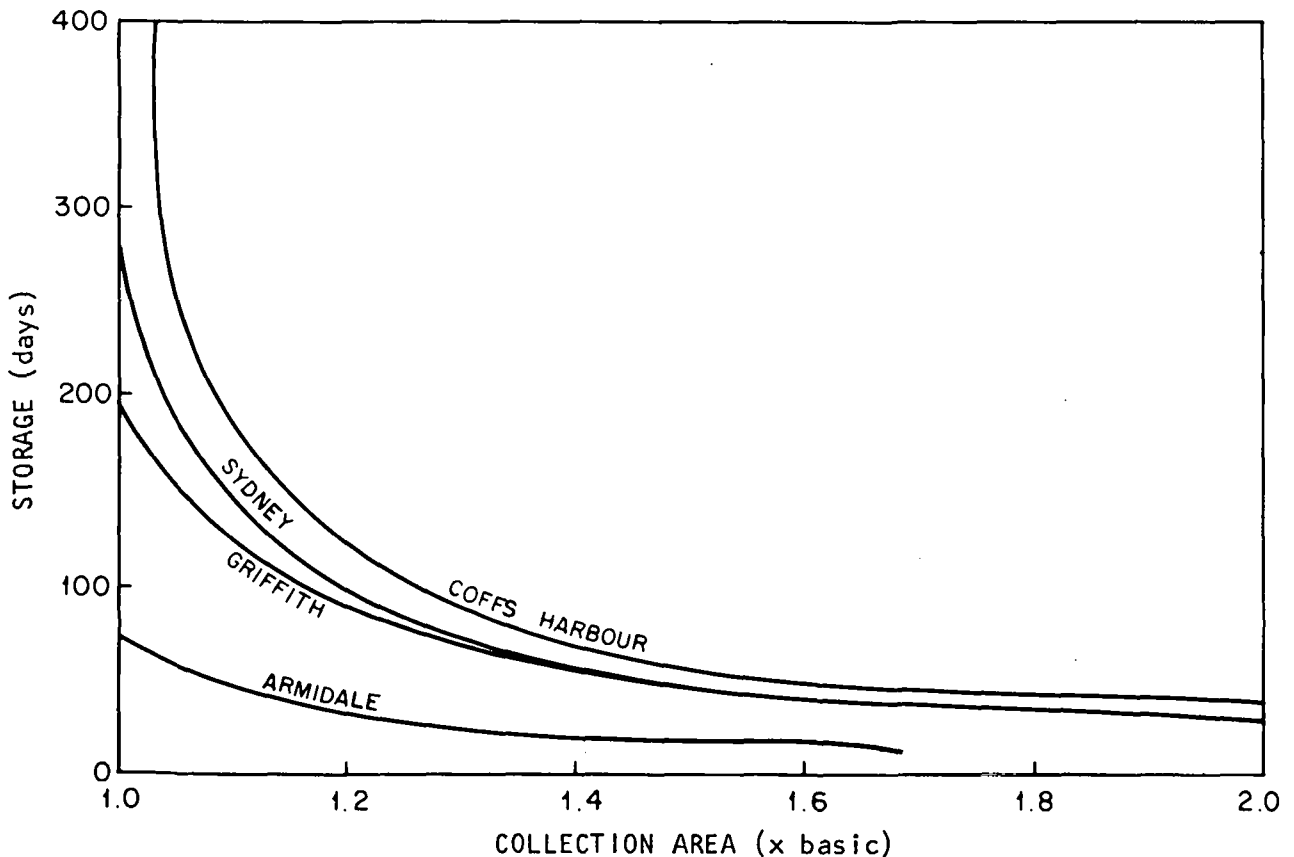

Figure 2. Acceptable combinations of catchment area and storage volume for four locations for a "failure" of once per year

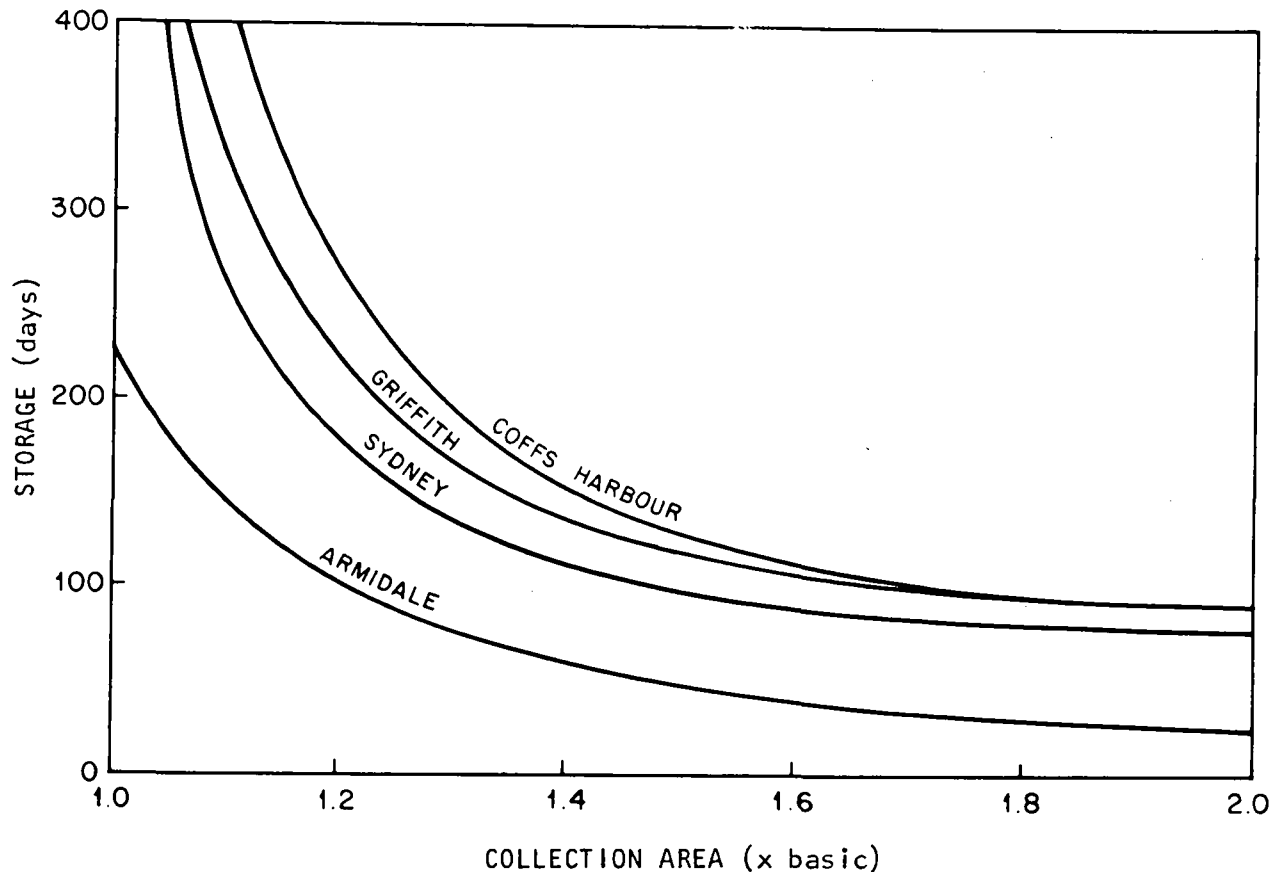

Figure 3. Acceptable combinations of catchment area and storage volume for four locations for a "failure" of once in five years

greater annual variability will have the effect of requiring a proportionately larger storage for a given reliability. The results in Figure 2 suggest that under these circumstances rationing may pay higher dividends in a more variable rainfall environment.

Another aspect of this is illustrated in Figure 4 which shows the effect of storage size on reliability of supply at each location assuming a catchment area of 1.3 x basic. The curves indicate a very similar form of relationship for Armidale, Coffs Harbour and Sydney. In this case, the increase of storage for Coffs Harbour or Sydney compared to Armidale is a reflection of the greater variability within the year (presence of a marked summer dominance of rainfall) and, presumably, annual variability for Sydney which has no seasonal dominance of rainfall. For Griffith, however, the relationship appears quite different. Although this is clearly a function of the rainfall variability there, no full explanation for this is yet available.

Improved reliability from rationing is only achieved at the expense of some shortfall in the supply when rationing is imposed. Figure 5 attempts to show the relationship between the various design parameters and the required time for rationing. The results for Coffs Harbour have been chosen only for illustrative purposes. It can be seen that, in general, a higher reliability is associated with fewer occasions on which rationing is required. At first such a result appears to be quite the reverse of what might be expected. How-

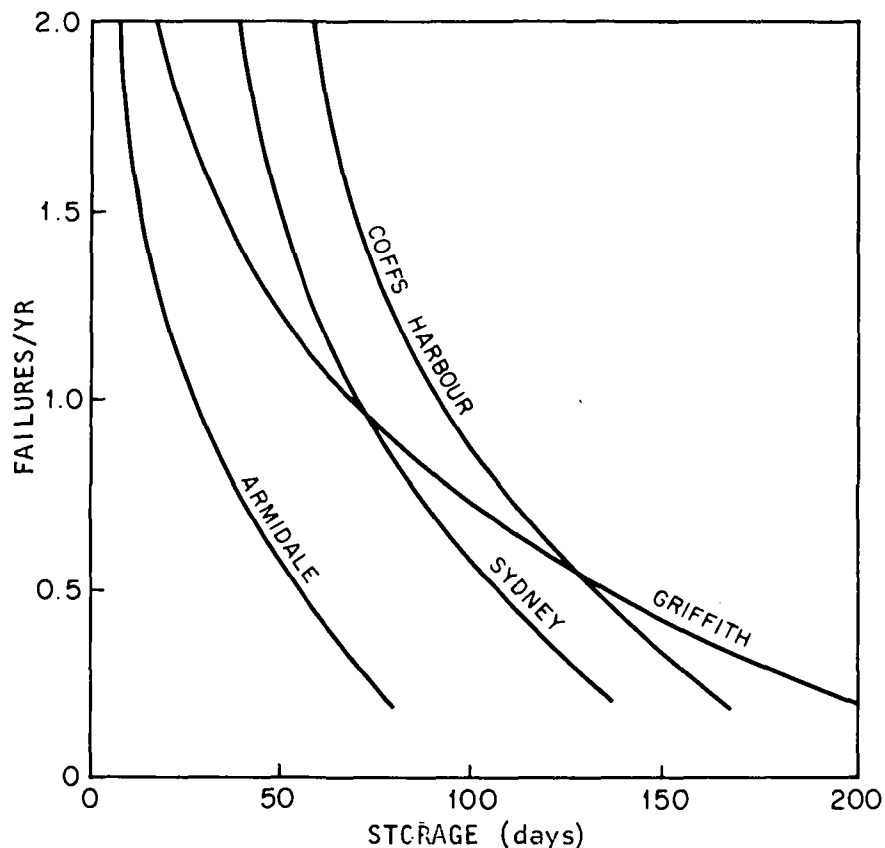

Figure 4. Effect of acceptable reliability of supply on storage requirements for a system having 1.3 times the basic catchment area.

ever, the explanation is that the high incidence of rationing and the high failure rate are associated with rainwater supply systems which have either inadequate storage or inadequate catchment area. It can be seen that a system with a 130-day storage but only 1.0 times the basic area can be expected to fail twice per year and require rationing 5 times/yr.

To achieve a more reliable supply, a much larger system must be built. In the example quoted above, an increase in catchment area to 1.4 times the basic would increase the reliability to 1 failure/5 yr and, at the same time reduce the number of times that rationing is imposed to an average of 1.6 times/yr.

#### CONCLUSIONS

Even a simple rationing policy which reduces consumption in stages depending on the number of days that supply remains can have a significant effect in improving a rainwater supply system. This improvement may be utilized by

1. Improving reliability of a given system

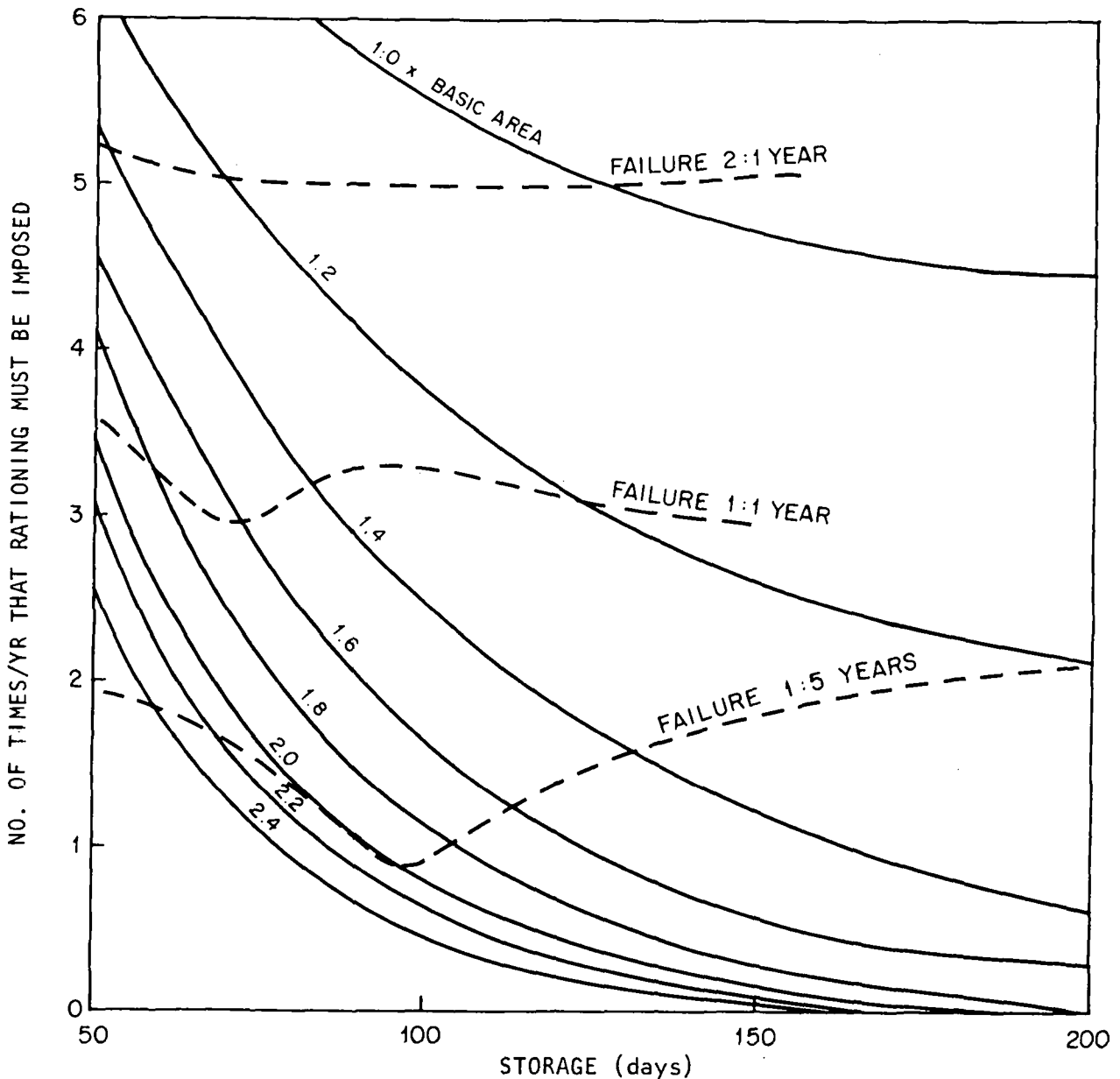

Figure 5. Number of times per year that rationing must be imposed at Coffs Harbour for various combinations of catchment area, storage volume and reliability of supply

2. Decreasing the required catchment to achieve the same reliability of supply
3. Decreasing the required storage for the same reliability
4. Increasing the yield of the system for the same reliability.

If the stated demand is increased while rationing is accepted, the total yield can be expected to increase despite the restrictions in supply at the time of rationing. It appears, therefore, that rationing should be considered as a means of increasing the yield of any water supply system. In an example analyzed in this study, a 20% increase in state demand for a particular locality was shown to require a 10% reduction from the original demand for 25% of the

time but to give a total increase in yield of 12.5%.

This study has only examined one simple rigid rationing rule which has been shown to have significant effects. Clearly, other rationing rules could be devised to optimize the performance of a rainwater supply system. In areas where there was a distinct seasonality of rainfall, for instance, a rule might take into account both storage contents and the season of the year.

This study has shown that even a very mild rationing policy should be considered as a possible strategy for improvement of a rainwater supply system along with catchment area, storage volume and reliability of supply.

#### REFERENCES

- Body, D.N. 1968a. Design information for domestic water supply from roof runoff. Progress Report, Commonwealth Bureau of Meteorology, Melbourne, Australia, 28 p.
- Body, D.N. 1968b. Design of water supply services based on impervious catchment areas. Progress Report, Commonwealth Bureau of Meteorology, Melbourne, Australia, 11 p.
- Perrens, S.J. 1982. Design strategy for domestic rainwater systems in Australia. In Int. Conf. Rain Water Cistern Systems, Honolulu, Hawaii. (In press)



## INTEGRATING RAIN WATER CISTERNS WITH PUBLIC WATER SUPPLY SYSTEMS

Yu-Si Fok, Professor  
Department of Civil Engineering  
and Researcher  
Water Resources Research Center  
University of Hawaii at Manoa  
Honolulu, Hawaii 96822, USA

### INTRODUCTION

In recent years, many metropolitan centers have experienced water shortages, due partly to droughts as well as rapid urbanization. The latter has resulted in an oversubscription of existing water supplies. As a result, moratoriums on building permits have been reported in Orange County (Los Angeles, California) and in several counties in Hawaii. Developers in these areas were denied building permits and told to develop their own water source before building permits could be issued. As a result, many developers suffered losses in time, money, and business opportunities.

Thus, it is evident that alternative water sources must be found to alleviate water shortage problems in urban areas. Rain water-cistern systems are practical alternative or supplemental water supply systems which have long been used prior to the development of public water supply systems. During the 1977 California drought, Monterey peninsula residents recycled their limited 50 gal/person/day water rations to irrigate their gardens and lawns, and utilized rain cisterns to supplement their recycled water. These emergency water management practices reportedly reduced revenues to the water supply agencies, thus creating a financial problem for the water supplier. Therefore, when a potential, alternative water supply system is contemplated, related problems discussed in this paper should be solved before the alternative is integrated into the existing water supply system.

### PROBLEM IDENTIFICATION

Urban water managers may be reluctant to accept rain water-cistern systems as an important alternative because the cistern systems could reduce revenues for existing water supply systems. An additional concern could be the quality of the cistern water. Two problems of concern to the private owner/operator are the cost of cistern systems and the dependability of rainfall which is the main source of cistern water.

Four problem areas for the integration of rain water-cistern systems have been identified:

1. Maintenance of public water supply system revenues
2. Quality of cistern catchment water
3. Cost of the cistern system
4. Dependability of the cistern system.

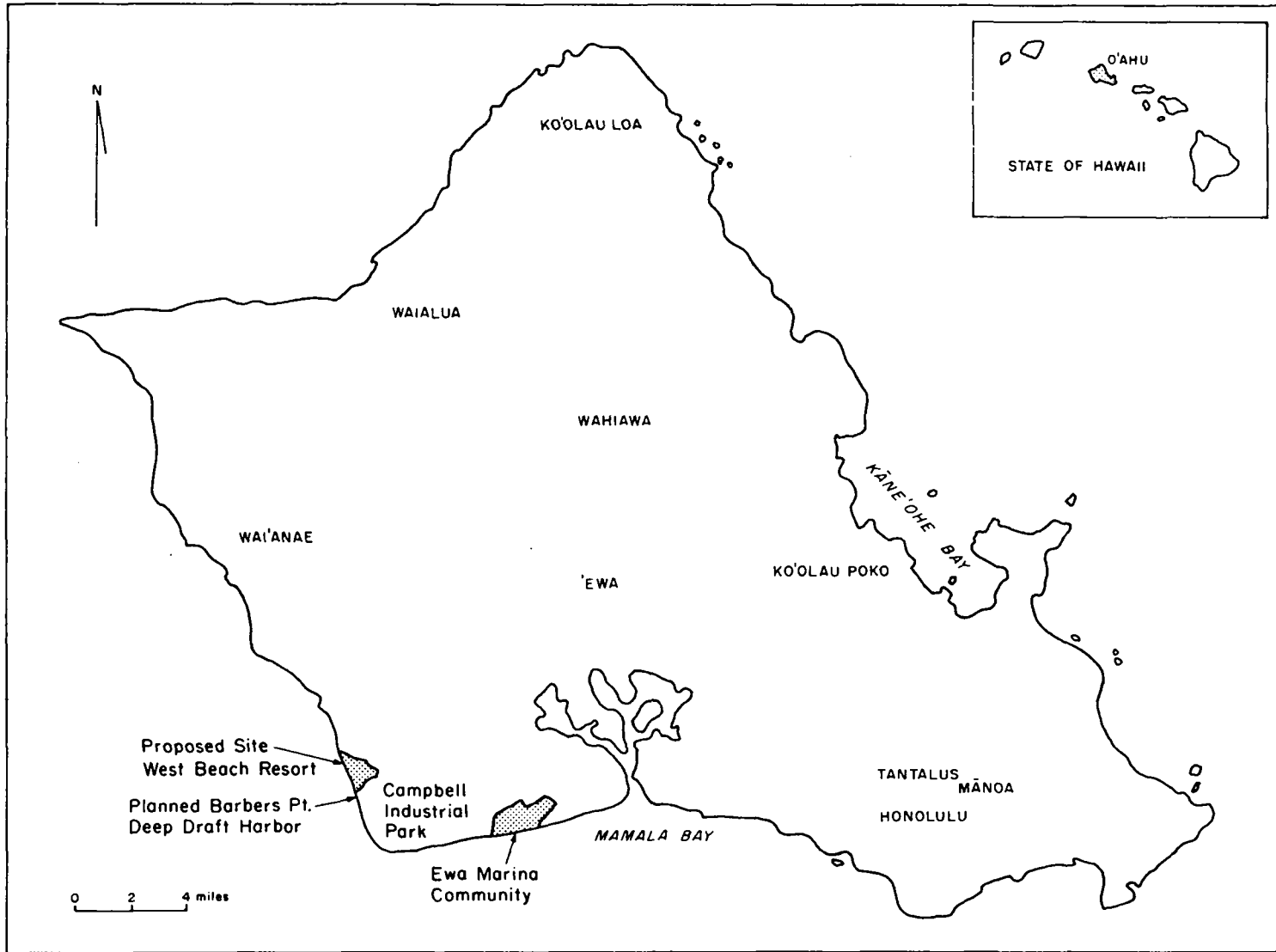

Figure 1. Proposed Marina and Lagoon Development near Barbers Point, Ewa District, O'ahu, Hawai'i

In this paper, the first problem area is discussed in detail, while the remaining problem areas are briefly discussed because they are addressed in detail in others papers of this conference.

#### MAINTENANCE OF PUBLIC WATER SYSTEM REVENUES

Public water systems are basically funded by revenues received from users, and capital or initial costs are generally financed by the issuance of revenue bonds. Thus, the public water system manager is responsible for maintaining the balance of revenues and expenditures. When an alternative or supplemental water supply system is integrated into the public water supply system, its impact on revenues must be assessed and mitigated so that it can be accepted as a part or component of the water management scheme of the existing system.

The main criterion for integrating rain water-cistern systems with the existing public water system is the alleviation of water supply shortages. With increasing urbanization, the existing and future limits of available water supply are hard pressed to meet the demand during periods of drought conditions. To develop additional sources of water, increased funding is necessary. Thus, rain water-cistern systems should be considered as a viable alternative to supplement public water supply systems.

The feasibility of integrating rain water-cistern systems with existing systems can best be illustrated by an example. The selected urban example area is situated in the arid Ewa plain in the southwest region of Oahu Island, Hawaii. In November 1980, developers of two urban development projects in the Ewa plain submitted environmental impact statements for approval. One is the West Beach project which will convert more than 259 ha (640 acres) of sugarcane land into a resort/residential area at a construction cost of \$972 million with a water supply demand of 0.319 8 to 0.346 1 m<sup>3</sup>/s (7.3-7.9 mgd). The other project is the Ewa Marina Community project which will convert 445.2 ha (1100 acres) of land—including 289 ha (714 acres) of sugarcane land—to urban use for 21,000 residents at a cost of \$572 million with a water demand of 0.184 m<sup>3</sup>/s (4.2 mgd).

Both projects have water supply problems. The City and County of Honolulu Board of Water Supply (BWS) cannot make any commitments to these projects because they are situated in the Pearl Harbor watershed basin whose aquifer is heavily stressed. The Hawaii State Department of Land and Natural Resources has imposed a restriction on further groundwater development in this basin because of evidence of salt-water intrusion in many well groups. This water shortage impact is serious because Honolulu is facing a housing shortage problem where the vacancy rate has dropped to the dangerous 2% level. Without the implementation of these two sizeable residential development projects, the housing shortage may reach a crisis because Oahu's annual requirement for new housing is more than 1500 units. Locations of the two project sites are shown in Figure 1.

THREE-WAY WATER SUPPLY TRADE-OFF ANALYSIS. In the Ewa District, the annual rainfall is only 635 mm (25 in.). Thus, it is evident that the dependability of rainfall would be very low for rain water-cistern systems in this project area. On the other hand, there are many high rainfall areas on Oahu,

for example, Manoa Valley which has an annual rainfall of 3 048 mm (120 in.). Therefore, Ewa District developers can explore the possibilities of a three-way trade-off.

An urban developer can offer to install free rain water-cistern systems to Manoa Valley residents. As a result, these Manoa Valley residents provided with free rain water-cisterns will use less public water, thereby decreasing water demand and the amount saved in Manoa may be allocated to the Ewa plain urban development. Under this arrangement, revenues for the Board of Water Supply are protected because water users in Manoa will continue to use some of the public water or at least pay the agreed upon minimum public water supply fee, and the Ewa plain project households will be new Board of Water Supply customers. The developers can then proceed with their housing project without any delay due to the restrictions placed on groundwater withdrawal from the Pearl Harbor basin. The cost of building rain water-cistern systems will be borne by the Ewa plain buyers.

This three-way trade-off water supply concept is a promising approach and benefits all. The Board of Water Supply will maintain its revenues by balancing lesser use in Manoa to offset supplying the Ewa urban development area. The developer will need to supply fewer rain water cisterns because Manoa Valley has an annual rainfall five times greater than the Ewa plain. Each participating resident in Manoa Valley will receive a free rain water cistern and, as a result, will reduce their water bills.

NO TRADE-OFF STRATEGY FUNCTION ANALYSIS. To illustrate that the three-way trade-off is the best approach, an analysis of no trade-offs can be conducted by assuming that cisterns will be built for each new building for its water supply in the Ewa District. Because the annual rainfall in the Ewa District is low, periodic water shortages are expected. When this situation occurs, the public water supply system will be used as the supplemental water source and for fire protection. The cost function developed in this no trade-off approach is, in itself, an alternative for using rain water-cistern systems to solve water shortage problems where local variations in annual rainfall is not significant. Other institutional policies for this approach should also be studied.

#### OTHER INVESTIGATIONS

Other alternatives should also be investigated for the solution of the water shortage problem in the Ewa plain area. The alternative of integrating rain water-cistern systems with public water systems should also be made. In each case, public water supply system revenues are maintained and protected.

For example, the possibility of using roof solar energy for distilling a limited amount of cistern water for human consumption regardless of whether the source of cistern water is from rain water or from existing sugarcane irrigation wells should be explored. This would introduce dual water supply systems for households. One system would provide cistern water with high water quality standards for human consumption; the other water system would have lower standards for uses requiring a lesser water quality.

## WATER QUALITY POLICY FOR CISTERN SYSTEMS

The water quality of rain water cistern systems has been the topic of one session, therefore, the following deals only with water quality policy.

The dual system concept by traditional practice includes boiling water for drinking, and filtering or adding chemicals to treat "raw water". In the U.S., the public water supply standards are set very high to provide potable water safe for drinking. However, to maintain this high water supply standard requires a high initial cost and operation and maintenance costs. Ironically, these high quality waters are being used for toilet flushing, bathing, clothes laundering, and dish washing, as well as for washing cars, irrigating lawns, and filling swimming pools. Consequently, it is not difficult to see that the per capita water demand in the U.S.A. is rising and creating water supply shortage problems.

## COST OF CISTERN SYSTEMS

The cost of cistern systems is discussed in this conference by Fok and Leung (1982). Readers of this paper should thus refer to this paper for the necessary information.

## DEPENDABILITY OF CISTERN SYSTEMS

The dependability of rain water cistern systems relies upon accurate estimates of seasonal rainfall. Because the prediction of rainfall is a stochastic process in the statistical sense, seasonal rainfall cannot be accurately forecasted. Several conference papers discuss the three statistical processes and the various methodologies of rainfall data to estimate seasonal rainfall. Thus, readers are referred to those papers for more information.

## CONCLUSIONS

Integrating rain water cistern systems with existing public water supply systems does not include mixing waters of the two systems. Instead, rain water cistern systems are proposed as alternative or supplemental water supply systems which can be included in the water management scheme to alleviate water shortage problems.

This paper presents an example of integrating rain water cisterns with the water supply systems of the City and County of Honolulu. A three-way trade-off water supply is suggested for the Ewa housing development in Honolulu and for house owners in Manoa, Honolulu and the City and County of Honolulu Board of Water Supply. This example showed that when the water development cost is sufficiently high, a three-way trade-off would be practical.

In the discussion of the water quality of rain water cisterns, the maintenance of high U.S. drinking water standards for all uses (potable and non-potable) was discussed as not being economical.

REFERENCE

- Fok, Y.S., and Leung, P. 1982. Cost analysis of rain water cistern systems. In Rain Water Cistern Systems, Proc. of the International Conference on Rain Water Cistern Systems, Water Resources Research Center, University of Hawaii, Honolulu, Hawaii, 15-18 June 1982

## CISTERN SYSTEMS: THE CALIFORNIA PERSPECTIVE

Alan Thane Ingham  
Associate Engineer

Charles Franklyn Kleine  
Senior Engineer

Water Resources  
Department of Water Resources  
State of California  
1416 Ninth Street  
Sacramento, California 95814, USA

### INTRODUCTION

The California drought of 1976-1977 focused attention on the limits of conventional water supplies at the state and the local levels. Most of the rainfall occurs in the northern portion of the State, whereas the principal metropolitan developments are in Southern California. To provide water supply for these developments and for agriculture, largely in the San Joaquin Valley of Central California, the State Water Project (SWP) was developed to collect water in reservoirs in Northern California, and to transport this water to Southern California using pumping plants and over  $64.36 \times 10^4$  m (400 miles) of aqueduct. The system is currently supplying about 60% of its contracted entitlements. As originally planned, the ultimate development of the system would require construction of new reservoirs and canals beyond those now constructed. In many developed areas of the state, natural surface and groundwater sources are fully developed. The 1976-1977 drought reinforced California's recognition that her water resources were limited; this, coupled with increasing energy costs for pumping water to major urban areas and political and environmental changes occurring in the last 10 years, encouraged the development of statewide programs to expand existing conventional supplies by reclaiming municipal waste waters and to promote conservation practices for both urban and agricultural water users. Sometimes these programs involved the investigation into the potential for innovative development of water supplies, such as coastal fog recovery and cistern technology. California's program to develop cistern systems is unique. In this paper will be discussed the background, elements, and benefits of cistern technology and California's program encouraging the development of these systems. It is hoped that this program will serve as a model for other states when they plan their overall water development programs.

The technical discussion presented in this paper will address the State's residential usage of water, the advantages of grey water as an alternative supply of landscape irrigation water, and the typical elements of cistern systems used in California. Attention will then be directed to reviewing the regulations and management of cistern systems; California's tax incentive program for developing residential cistern water supplies; and a program for implementing demonstration cisterns for planners, engineers, health officials, and the general public. The paper will close with a presentation of cistern benefits to the individual region and the state; and hence, governments' responsibility to encourage this worthwhile technology.

### TECHNICAL DISCUSSION

Due to California's unique climate, grey water can be an important addi-

tion to rain water cisterns to provide a dependable water supply throughout the year. The technical discussion will describe residential water usage in California, and the concepts of grey water reuse—its benefits, and constraints. Finally, the discussion will describe the typical elements of a gray water/rain water cistern system which enables the development of both water supply sources, while conforming to guidelines for protecting public health.

RESIDENTIAL WATER USAGE IN CALIFORNIA. According to the California Department of Water Resources (1976), California uses approximately two times the national average residential water consumption of about 0.87 m<sup>3</sup>/capita/day (230 gal/capita/day). Of this, approximately 0.38 m<sup>3</sup>/capita/day (100 gal/capita/day) or 43% is used outside of the home. Most of the exterior water usage is for landscape irrigation in the dryer Southern California area. On the average, 90% of the exterior water usage is for landscape irrigation. This amounts to approximately 35 to 40% of the total water consumption of the California household. It is the water used for landscape irrigation which can be benefitted by the use of the cistern system. Even though the landscape irrigation requirements are about one and a half times the quantity of grey water generally available, any reuse of grey water will reduce the amounts of potable water used for this purpose, an important consideration for metered areas of the state. This deficit can be further reduced when grey water is combined with collected rain water as an irrigation water supply.

GREY WATER AS AN ADDITION TO THE RAIN WATER CISTERN. California's seasonal rainfall makes the exclusive use of the rain water cistern inappropriate in many locations of the state. Rain water cistern design for seasonal rainfall areas of California results in systems of two kinds:

1. Moderate sized cisterns serving very limited landscape areas
2. Extremely large systems serving small landscape areas.

In either case, the investment in terms of cost per irrigated area, can be quite high. Since California looks to the cistern system as an augmentation for the residential water supply, one can turn to the ever present grey water source.

GREY WATER, AND HOW IT CAN IMPROVE THE RAIN WATER CISTERN. It is easier to define what grey water is not, rather than what it is. Grey water is all waste water generated in the home which does not contain toilet wastes, which are commonly termed "black water". Grey water is typically discharged to the sanitary sewer with black water.

Since grey water is generated on a continuous basis, the cistern volume can be significantly reduced from that required to store rainfall on a seasonal basis. Although the suspended solids content of grey water may require more frequent system maintenance than rain water alone, its benefits exceed the disadvantages over the latter systems.

HEALTH EFFECTS. The primary risk of grey water use is its potential threat to public health. Grey water can contain pathogens which may cause illness. This health concern is also present when rain water is combined with grey water. To understand the source of contamination, an examination of grey water collection points is necessary. Typically, grey water is collected from the shower, bath, wash basin, laundry and sometimes the kitchen sink. Contamination can enter the grey water from laundered diapers or urination in the



shower or bath. The presence of kitchen food particles can cause odors and attract vectors.

To provide some understanding of the risk grey water use poses to public health, Professor R. Cooper (1977) discussed the mechanism responsible for waste water-borne disease. Illness results first from the presence of the disease agent. Secondly, its severity would depend on the concentration of the bacterial agent and the host's particular resistance to illness. The prevention of disease can rely on any interruption of the disease causing mechanisms discussed. Most commonly two approaches are taken: provide treatment to eliminate the disease agents and/or prevent contact between the agent and host, which most health officers attempt to prevent in the case of grey water. The use of grey water cisterns can provide possibilities for contact between a disease agent and a host. Also included in the consideration of health effects is the potential danger of cross connection should a grey water/rain water system be used in a home to provide an alternative water supply for toilet flushing. For these reasons, health officers are cautious in approving dual systems.

Because of the potential impact on public health, the State Department of Health Services put forward three simple guidelines regarding the use of grey water or combined grey water/rain water cisterns. First, the water from a cistern must be used exclusively for noncontact landscape irrigation; second, in the case of a grey water system, the landscape irrigation must be applied with an underground system, such as drip irrigation; and third, the system must meet with the approval of the local health officer. It is this last requirement which may place additional constraints on cistern systems.

**SYSTEM ELEMENTS.** The types of cistern systems are as varied as are applications. Murray Milne (1979), discussed the many different kinds of grey water systems. Bulletin 213 by the California Department of Water Resources (1981) described the various elements of the rain water cistern systems. This bulletin provides a detailed account of California cisterns as presented at a Department sponsored seminar held in Monterey, California in 1979. Generally, the elements distinguishing a grey water/rain water cistern are few; both systems require collection plumbing, which in the case of rain water originates with the roof gutter or some other collection surface. When grey water is added, the collection plumbing connects the shower, laundry, sink, bath and, sometimes, the kitchen sink.

The elements of the cistern system are changed very little to provide for combining grey water with rain water. The elements of a combined system are shown in Figure 1. Collection systems are constructed from each source of supply. A dosing siphon is provided to periodically dose grey water onto an intermittent sand filter. The dosing allows the filter to periodically dry out and restore its percolative capacity.

The common cistern tank is then provided for storage of the collected grey water. When rain water is directed to the system, a separate filter and collection sump are provided. The sump has an overflow to the storm sewer. Whenever the water level in the main cistern is down, a float valve allows for the addition of rain water to the cistern from the sump to maintain the cistern at capacity. In such a system the grey water is given priority to maintain the cistern filled. If grey water is unable to keep the cistern full,

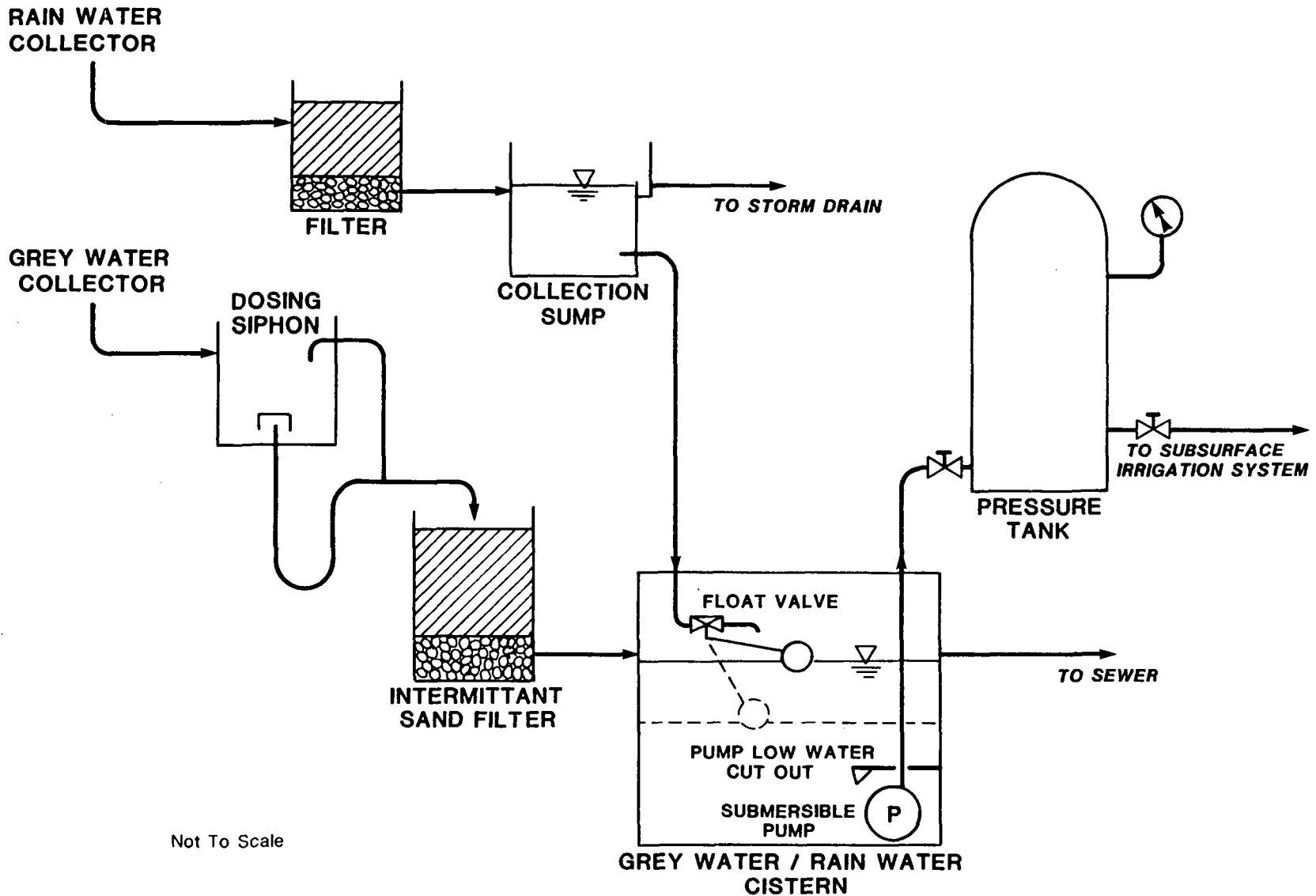

Not To Scale

Figure 1. Combined grey water and rain water cistern system schematic

then rain water is used to make up the additional difference. The main cistern is provided with an overflow to the sanitary sewer which enables any additional grey water to be safely carried away preventing contact with the system user. The water in the grey water/rain water cistern is pumped to a pressure tank for distribution to the irrigation system. If chlorination is needed, it can be accomplished prior to the pressure tank.

#### GOVERNMENT REGULATION AND CISTERN INCENTIVES

REGULATION OF CISTERN SYSTEMS. Due to the health-related aspects of grey water or combined rain water and grey water cisterns, regulation is a prime consideration of the cistern system program. Previously, the California Department of Health Services guidelines were addressed. Their requirements for subsurface grey water irrigation limited to landscaping are general requirements in addition to any specific requirements placed on the system by the local health officers.

This authority of the local health officer has been delegated to them by the California Regional Water Quality Control Board, who are responsible for waste discharges in California. Due to staffing limitations at the Regional Boards and because local areas have sufficient expertise, the local health officer is delegated approval authority for grey water cisterns. The regulation of on-site waste water systems in California is discussed in detail by Walker and Ingham (1980). Since the regulation of grey water cisterns fall under the jurisdiction of the local health departments, their requirements include and often extend further than those of the State Department of Health Services. Prior to the 1976-1977 drought, all 58 of California's counties forbid the use of grey water; however, the use of grey water is now allowed for landscape irrigation in many counties. According to the California Department of Health Services (1979) telephone survey, approximately 15% of the counties have some official provisions for allowing these systems. Frequently, people find themselves up against traditional policies often supported by quoting the Uniform Plumbing Code which simply forbids the reuse of any waste water from the home. This is the single most common cited justification for forbidding grey water use.

As information on grey water cistern systems and of their benefits becomes more common, local level policymakers are becoming more receptive to the concept of grey water use. Consequently, we are slowly seeing an increase in numbers of grey water and rain water cisterns. The state agencies associated with water and waste water management in California have taken a positive and an encouraging stand on the issue surrounding grey water and rain water cisterns. The California State Water Resources Control Board encourages the use of grey water to improve rural waste water management practices. The California Department of Water Resources is administering a water conservation tax credit program and a demonstration program which will be discussed later. The Department of Health Services participated with the Department of Water Resources in developing a workable set of guidelines for the cistern system tax credit program. With this encouraging policy by state agencies coupled with the lessons learned by the 1976-1977 drought, the state is seeing an increase in the use of grey water and rain water cisterns.

Prior to 1979, California did not have the necessary legislation to estab-

lish a local waste water management district. California Senate Bill 430 (1978) introduced by Senator Peter Behr became effective January 1978 and provided the necessary legislation to establish a local waste water management district. The management district provides an organized program of routine inspection, revenue collection, design review, construction inspection, and enforcement, to ensure proper operation of on-site waste water management systems. This same concept can be applied to the management of cistern systems. This was discussed in a publication by Ingham (1980). In this way, the local health authority is assured of proper operation and maintenance while being freed of the duties of direct involvement. The cistern management concept is applicable only to communities of sufficient size to warrant and support such a program. California is still in the process of establishing its initial waste water management districts and presently does not have cistern management programs. We see this as a future solution to an anticipated need. The cistern management district can be an effective organization for ensuring proper cistern operation and maintenance.

**TAX CREDIT INCENTIVES.** The implementation of water conservation programs or alternative water source development, such as cistern systems, benefits not only the water user but the state in general. Conservation and alternative water supply facilities make conventional water supplies available for other uses. In consideration of the shared benefits to the state as well as the water user, the Governor signed Assembly Bill 1150 (Water Conservation Tax Credit Law) authored by Assemblyman William Filante (1980). Assembly Bill 1150 provides for a 55% tax credit of up to \$3,000 for the implementation of rain water or grey water cisterns, subject to the state and local constraints discussed previously, and for the installation of water conserving fixtures, such as shower heads and low-flush toilets as a replacement of older fixtures. There are no restrictions placed upon the location, age or size of the dwellings to be served by the cistern system under this program. In California, cistern systems for residences other than single-family dwellings, such as apartment complexes and condominiums, may take advantage of the same credit as single-family dwellings. In addition, when the cost for a system serving multiple-family dwellings exceeds \$6,000, the credit allowed is greater of \$3,000 or 25% of the cost of the water conservation system. There is no upper limit. It is emphasized that California is offering a tax credit which is deducted from the taxes due, not the taxable income. Should the size of the credit exceed the state income tax for the year claimed, the taxpayer may carry this credit forward to subsequent years until the total tax credit is received. This program is in effect for the 1980, 1981 and 1982 tax years. Prior to the end of the program, the California legislature will evaluate the use made of the program and will consider extending the credit to subsequent tax years as they have with the solar energy tax credit. California now leads the nation in solar energy installations; it is hoped that the cistern incentive program will likewise promote California as a leader in the area of water conservation and alternative water supplies.

The California Department of Water Resources, Franchise Tax Board, and Department of Health Services prepared guidelines for administering the Water Conservation Tax Credit Program. These guidelines appear in the California Administrative Code (1981) Title 23, Subchapter 1.8. The taxpayer taking credit for a cistern system, completes a line on his state tax form indicating the amount of his credit. He then attaches a statement to the tax form, indicating his method of credit computation. In addition, he identifies the sys-

tem location and details on separate maps which are mailed to the Department of Water Resources along with the statement of the cistern uses as approved by his local health officer.

The Department then reviews the cistern for compliance with the guidelines. The Franchise Tax Board is notified to exclude tax credits for those taxpayers whose systems are found ineligible. A written statement is prepared by the Department and sent to the Board identifying the specific reasons for rejections. The Department of Water Resources is also given the responsibility for public information concerning the program. Toll-free telephone numbers are available to answer taxpayer questions covering technical aspects of the program. Questions concerning tax aspects are directed to a Franchise Tax Board toll-free telephone number.

**CISTERN DEMONSTRATION PROGRAM.** The Department of Water Resource plans the demonstration of several grey water/rain water cisterns in publicly visible parts of the state. Most of the cisterns will be concentrated in Southern California, since this technology may best benefit the large Southern California urban areas which depend upon Northern California water for most of their supply. This program provides funds for the design and implementation of the demonstration cisterns, which are open to the public for first-hand inspection and information. Studies are conducted on the water quality, impacts on plants and soils, and general cistern economics. In addition, public information materials are prepared and a final report will identify guidelines for implementing grey water/rain water cisterns as supplemental water supplies.

#### CONCLUSION

**CISTERN BENEFITS.** The use of rain water and/or grey water provides an obvious direct benefit to the system user—a lower water consumption, hence, a reduced cost for water. This is particularly true as water bills increase because of water conservation programs to discourage residential water usage which reduces revenue to repay water agency debt costs. For the rural homeowner, savings in the form of electrical energy and pump maintenance are the most obvious direct benefits.

The use of grey water and/or rain water has many secondary benefits to the community and the state in general. The use of cisterns directly affects the water supply. As grey water and rain water replaces the potable water formerly used to irrigate landscapes, this potable water is then available for other more beneficial purposes. In so doing, the community improves its total water supply picture.

Reflecting now on California's unique water project, the implementation of a cistern water supply in Southern California benefits not only the local areas, but the SWP in general. Conservation at the local level enables the postponement of additional freshwater development projects, as well as providing additional quantities of delivered potable water to higher priority uses within the community, the region and the state. In this way, the total water supply picture is improved by furthering the benefits of conventional supplies. For this reason, the state of California considers the promotion of grey water and rain water use to be an important part of the state's effort to save and expand its water supplies. If people are to truly become conscious of the im-

portance of saving water, it is necessary for them to actually practice it. The promotion of rain water and grey water cistern technology offers the citizen the opportunity to become personally involved with the water saving ethic by developing his own supplemental water supply. The saving of water once appreciated by the individual can then be applied on a larger scale to the community or to industrial projects by concerned citizens, and thus provide significant savings by expanding the total urban water supply.

In the more rural locations of the state, the use of grey water and rain water can be of particular benefit in extending the limited local water supply which often comes from a well or springs. In the rural community, waste water management is typically by a septic tank and a leach field. Through the collection of grey water, lesser quantities of water are placed into the septic tank, thereby improving performance in both the tank and the leach field. Thus, many systems once marginal in performance can be rehabilitated simply by removing the grey water for other, more beneficial, purposes, as provided by the rain water/grey water cistern.

A MODEL FOR OTHERS. Although other states may not have the same hydrologic picture as California, they may benefit from a similar program. Certainly the problems of water supply for large urban areas are similar, as are the problems in rural areas dependent upon limited water resources for their survival. These areas may directly benefit from the California program. We see the merits of the cistern greatly extended when including the year-around sources of grey water. This enables the extension of the cistern concept to geographic areas unable to justify a sole source rain water cistern. With the advancement of technology, health authorities can then rely on reasonable criteria for regulating the systems. The installation of a local cistern management district is an effective way to ensure proper cistern operation and maintenance, while minimizing the impact on local health authorities. While cistern technology certainly is not appropriate for everyone, we see it as another valuable tool available to local and state planners to offer as an alternative for solving specific water supply problems. It is hoped that this paper has offered concepts for expanding cistern applicability while providing some insight into the water supply solutions available from cistern technology. As with many planning choices, the cistern management concept is simply an alternative for consideration when assembling an overall local regional or state program.

#### REFERENCES

- California State Legislature. 1978. California Senate Bill 430. Sacramento, California, January (introduced by P. Behr).
- \_\_\_\_\_. 1980. Water conservation tax credit law. Assembly Bill 1150, Sacramento, California, July (authored by W. Filante).
- \_\_\_\_\_. 1981. Residential water conservation tax credit. In California Administrative Code, Title 23, Subchap. 1.8, Sacramento, California, January.
- Cooper, R. 1977. Public health consideration of on-site waste disposal systems. In Rural Waste Water Disposal Alternatives, Appendix D, Phase 1,

Office of Appropriate Technology, State of California, Sacramento, September.

Department of Health Services. 1979. "Telephone survey of local health agency policies on grey water use." Sanitary Engineering Section, State of California, surveyed by Karol Enferadi, Berkeley, California, August.

Department of Water Resources. 1976. Water conservation in California. Bull. 198, State of California, Sacramento, May.

. 1981. Captured rainfall: Small-scale water supply systems. Bull. 213, State of California, Sacramento, May.

Ingham, A. 1980. Residential greywater management in California. Water Resources Control Board, State of California, Sacramento, January.

Milne, M. 1979. Residential water reuse. Rep. 46, Water Resources Center, University of California, Davis, September.

Walker, M., and Ingham, A. 1980. Waste water management for rural communities. Compost Sci. J. 21(5):35 (Sept.-Oct.); 21(6):31 (Nov.-Dec).

THE TERRACE-CISTERN SYSTEM:  
NEW PERSPECTIVES IN SOIL AND WATER MANAGEMENT

Ulpio Nascimento, Principal Research Officer  
Laboratório Nacional de Engenharia Civil  
Lisboa, PORTUGAL

INTRODUCTION

The basic idea presented in this paper is the combination of two very old techniques—land cultivation in terraces and rainwater catchment in cisterns—to form a terrace-cistern system whose potentialities are expected to exceed that of either technique by itself.

Such a system can open new prospects for land and water management. In the case of soil management, rainwater catchment for irrigation will make possible the reclamation of waste land and/or the introduction of new crops with higher yields. And for water management, a direct benefit will be the increase in the available water resources as a result of the collection and utilization of runoff; indirect benefits include the diminishing of soil erosion, and consequently, improving the operation of reservoirs and channels.

One may ask in what circumstances the implementation of this system becomes practicable from the technical and economic points of view. To throw light on this question, the Laboratório Nacional de Engenharia Civil recently started the research project reported here and which will require further research to solve some of the problems. That such research is needed is beyond question. In some of the most recent literature on water management, Cunha et al. (1980) concluded that research is not only necessary but also urgent.

This paper is presented to the International Conference on Rain Water Cistern Systems to profit mainly from any criticism and comments and to hopefully elicit cooperation in the pilot studies and the work to be done.

CONCEPTION OF THE TERRACE-CISTERN SYSTEM

The terrace-cistern (TC) system has two main objectives: (1) diminishing soil erosion by using the well-known terracing technique, and (2) catching and storing rain water, as well as minimizing evaporation by providing cisterns on the terraces.

Because the terracing technique is well known, it will not be discussed here, and only the cistern system will be presented.

The advantages of constructing cisterns on each terrace to store runoff water include: direct catchment on terraces without lift and conveyance requirements; minimization of evaporation and infiltration into the ground in the case of reservoir and dam storage; and the maximization of storing a greater portion of the amount of discharge. Thus, in the TC system, practically all of the water collected can be used, provided the cisterns are designed for minimal evaporation and infiltration.



Figure 1 is a schematic representation of the TC system having two terraces with a level difference,  $h$ , at distance,  $d$ . Each terrace should be designed to avoid runoff near the retaining walls to prevent erosion. Thus, the construction of ditches to control such erosion can be dispensed with.

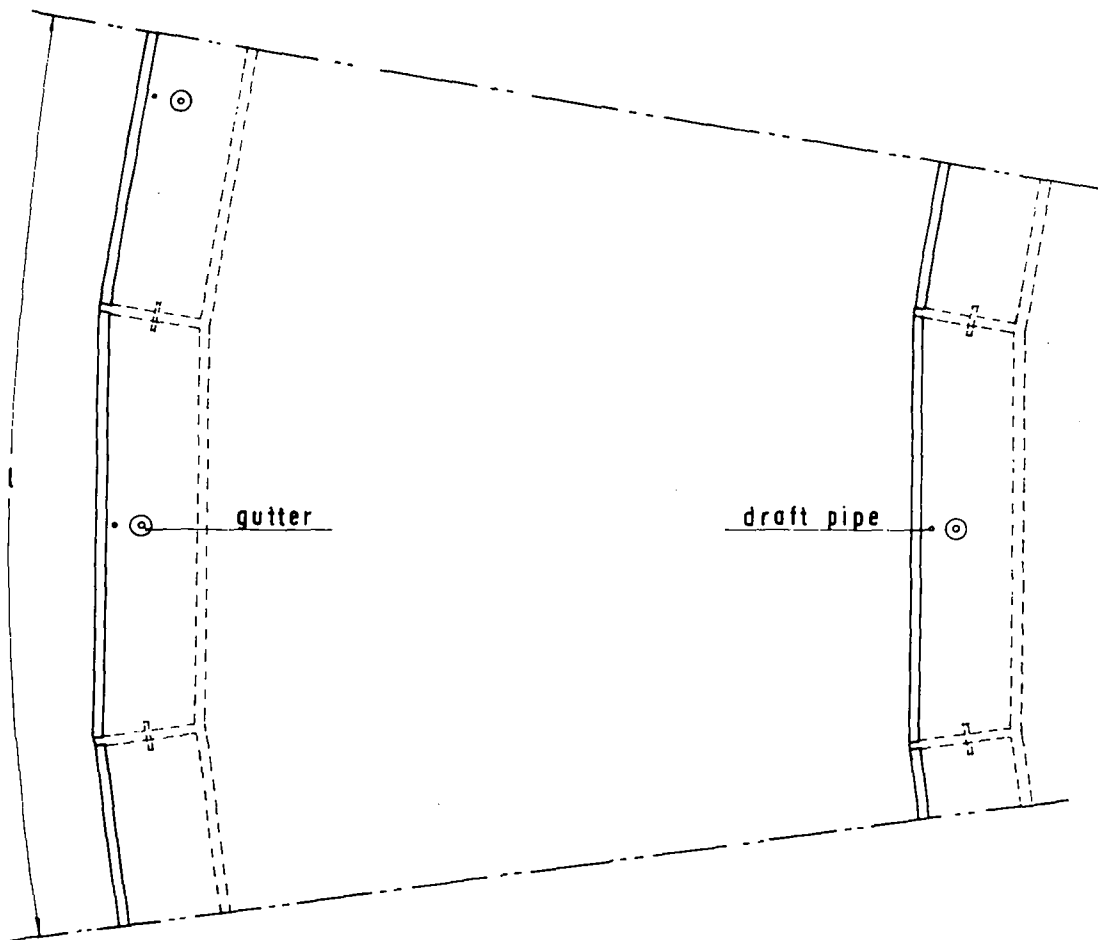
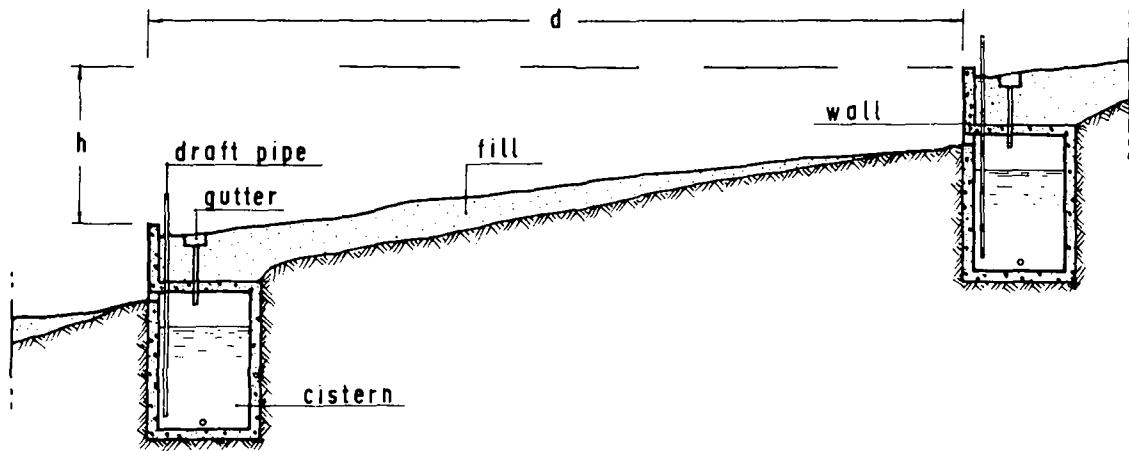

Figure 1. Terrace-cistern system

The distance,  $d$ , between terraces thus varies depending on the slope. The mean value of that distance for a given length of terrace 1 will be

$$d = \frac{A}{l} \quad (1)$$

where  $A$  is the area of the terrace measured between the upper and the lower walls.

The annual runoff volume for one linear meter of the terrace length is given as

$$V = C_e p d \quad (2)$$

where  $p$  is the mean annual rainfall and  $C_e$  the mean runoff coefficient of the terrace.

However, the distribution of  $p$  throughout the year is most variable. In the zone of Faro, for instance, the distribution is as shown in Figure 2 (Cunha et al. 1980).

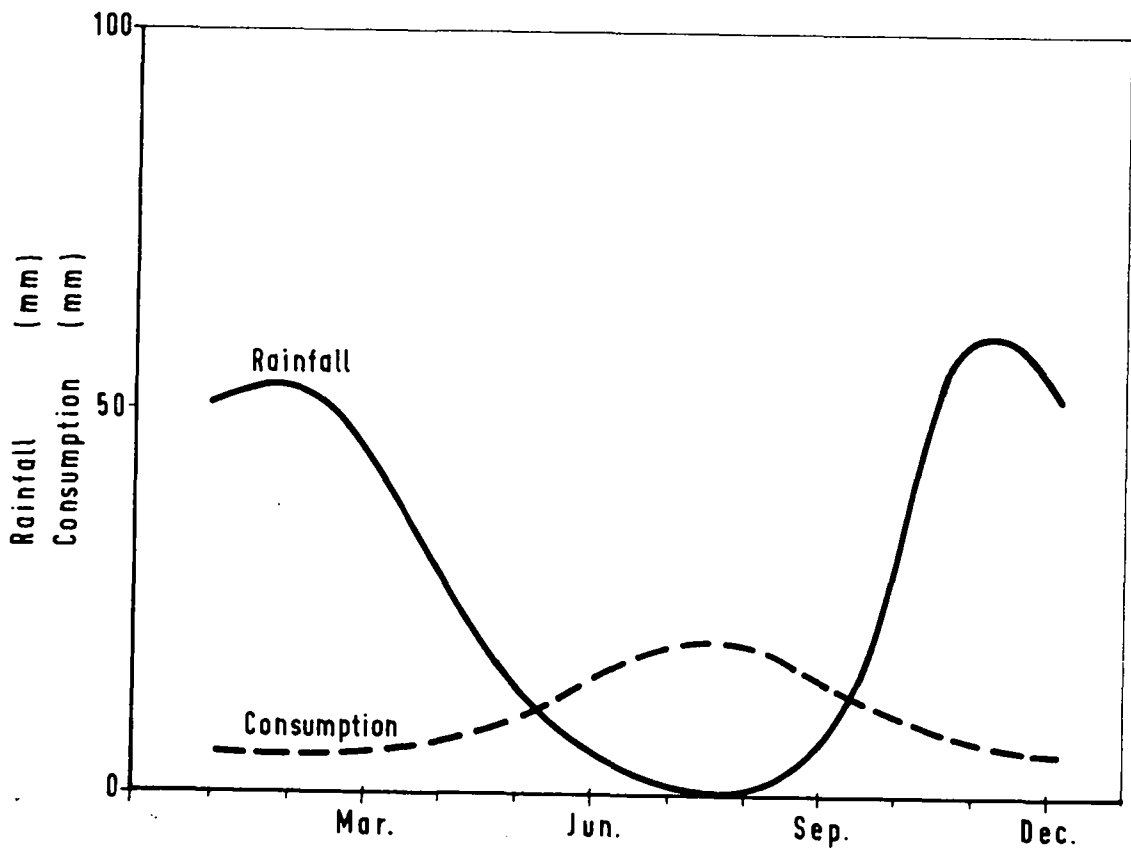

Figure 2. Annual rainfall at Faro compared with a hypothetical curve of water consumption

The mean annual rainfall of about 400 mm is concentrated during the October to March period, and is relatively scarce from April to September. With the TC system, water collected during the rainy season is intended for use during the dry period.

The capacity of the cistern required for that purpose obviously depends on the annual consumption curve foreseen for the water stored. For an upper limit, such capacity may equal the whole volume of annual runoff given in (2). This corresponds to the limiting assumption according to which all water is utilized in the dry period of the year. In general, however, such will not be the case, since there will also be water withdrawal from the cistern even in the rainy season, as shown in Figure 2 by a hypothetical consumption curve.

The design criterion for the capacity,  $V_c$ , of the cistern will thus be

$$V_c \geq C_a V \quad (3)$$

where  $C_a$  is the storage coefficient whose value, ranging from zero to one, will depend on annual runoff and consumption curves.

During the rainy season, the volume of runoff exceeding the capacity of the cistern will accumulate against the wall of the terrace until it overtops it and discharges onto the lower terrace.

The cistern is constructed as a trench dug in the ground. The excavated earth then forms the fill for the terrace. Thus, the construction of the cisterns, either underground or semi-underground, has the twofold advantage of supplying earth fill to the terraces and helping smooth the ground slope, and of providing increased protection to water against the higher surface temperatures.

To avoid infiltration losses, cisterns must have impervious walls or linings. Likewise, to avoid evaporation losses, they must be entirely sealed, excepting for the water intake and outlet openings.

Water is collected in terraces by means of gutters that should be designed to prevent as much as possible solid material suspended in water from entering the cisterns. Water is conveyed through a draft pipe to which a suitable pump is coupled. The draft head is very small (about 10 m), thereby making feasible the siphoning of water from the cistern for distribution to terraces at lower elevations.

The possibilities afforded by the TC system to cultivate wetland crops on terraces opens prospects for the reclamation and exploitation of land subject to severe erosion, and, thus, from the economic point of view, is more profitable than the classic system of simple terracing. In fact, given the usual water shortage, the range of crops that simple terracing allows is rather limited and the profit therefrom derived, if any, will be deferred or indirect in nature.

Because of the water savings it permits, the modern trickle irrigation system can improve the efficiency of the TC system since cisterns of smaller storage capacity may be constructed. Additionally, more extensive water use

will be available. Thus, the TC system seems suited for land reclamation and exploitation, particularly as regards waste, steep or degraded lands.

#### TECHNICAL FEASIBILITY

**TERRACES.** The technology of terraces for agriculture is already very old, and is being used in numerous regions of the world. In Portugal, the best known examples are found in Alto Douro and Madeira Island.

In keeping with its basic conception, that technology was recently adapted to resolve different geotechnical problems of erosion control and slope protection, where in some cases the walls of terraces were strengthened by anchorages (Nascimento 1952, 1967, 1974). Therefore, this is a widely tested technology, although some design problems are still being solved by empirical or semi-empirical methods and, thus, call for further research. As an example, mention should be made of the seasonal movements of surface soil on slopes and their impact on terrace walls (Nascimento 1955), and also of the quantification of soil erosion with a view to designing terraces (Nascimento and Castro 1974).

**CISTERNS.** As is true of terraces, cisterns for collecting rain water have also been used all over the world since ancient times. Rain water taken from roofs, yards, and threshing floors and conveyed to and stored in cisterns was, and continues to be practiced in some regions as the main source of water storage and supply, particularly for domestic purposes.

In the TC system, the difference lies in the fact that water is collected from runoff in open areas, and not from the surface of roofs or yards. In the TC system, water will thus be less "clean", than in the classic cisterns. Thus, this factor should be taken into account for catchment devices, water uses and treatment, if any.

In principle, the TC cisterns may be set underground or semi-underground. In the former case, either retaining walls will be required to form the terraces, or, instead, small embankments. In the latter case, cisterns themselves may act as walls.

If the ground is flat, the walls will not be needed since true terraces are not formed. Instead, the field layout should be such that the runoff is conveyed to the gutters at the inlet to the cisterns.

Cisterns may be constructed following the well-known technologies of concrete, stone, brick or block masonry. Yet other technologies may be considered, such as prefabricated reinforced concrete, asbestos-cement, steel plate or even plastics. Composite solutions can also be adopted, as for example, constructing the cistern using a form of impervious tissue which is insufflated in the trench, forming a balloon-shaped interior. The space between the balloon and the trench walls is then filled with plastic soil-cement or lean concrete prepared with the soil excavated for the trench. The impervious tissue should be impregnated with threads on the outside to ensure its adherence to the soil cement or concrete when set and the insufflation pressure has ceased.

The possibility of adding cisterns to already constructed terraces may also be considered.

## REFERENCES

- Cunha, L.V. et al. 1980. *A gestão da água: Princípios fundamentais e sua aplicação em Portugal*. Calouste Gulbenkian Foundation, Lisboa, Portugal.
- Nascimento, U. 1952. *Estudo da regularização e protecção das barrocas de Luanda*. Memória No. 30, Laboratório Nacional de Engenharia Civil, Lisboa, Portugal.
- Nascimento, U. 1955. *A acção do tempo e das interpéries nos solos*. Memória No. 72, Laboratório Nacional de Engenharia Civil, Lisboa, Portugal.
- Nascimento, U. 1967. Relato geral. Simpósio sobre estabilidade e consolidação de taludes. 2.<sup>a</sup>s Jornadas Luso-Brasileiras de Engenharia Civil, Rio de Janeiro-Sao Paulo, Brazil.
- Nascimento, U., and Castro, E. 1974. *Preventive measures against slope erosion. Criteria for soil selection*. IICong. Int. Assoc. Eng. Geology, Sao Paulo, Brazil, 1974. Memoria No. 451, Laboratório Nacional de Engenharia Civil, Lisboa, Portugal.

## UNDERGROUND PIPES TO RECHARGE RAINWATER STORAGE IN AQUIFERS

Katsuyoshi Ishizaki, Chief  
Hydrology Division  
Public Works Research Institute  
Ministry of Construction  
Asahi Toyosato-Cho  
Ibaraki Prefecture 305, JAPAN

Fumio Yoshino, Chief  
Flood Disaster Prevention Division  
Public Works Research Institute  
Ministry of Construction  
Asahi Toyosato-Cho  
Ibaraki Prefecture 305, JAPAN

Akira Terakawa, Research Engineer  
Hydrology Division  
Public Works Research Institute  
Ministry of Construction  
Asahi Toyosato-Cho  
Ibaraki Prefecture 305, JAPAN

### INTRODUCTION

Rainwater cistern systems have high potentialities to supplement and thus reduce the demands on public water supply systems if the storage tank cost can be made more feasible. In general, the cost of water tanks is relatively high in comparison to other components of the total rainwater cistern system. Thus, an underground aquifer can be considered as one method to minimize the total cost of rainwater cistern systems if an aquifer, rather than a storage tank, can be used to store rain water. Using underground pipes as an infiltration technique is a possible solution.

Underground pipes, which are permeable and buried in the topsoil, are being used for crop irrigation and also for drainage. They were recently found to be also useful in the field of groundwater recharge (Ishizaki, Kitagawa, and Terakawa 1981). Because ordinary methods to recharge groundwater, such as well injection and ponding, have common problems of clogging, considerable design and cost studies will be necessary to maintain them as infiltration facilities (Ishizaki and Kitagawa 1981). Because of aerobic conditions, underground pipes used for irrigation have little chance of clogging. Also, the cost of these pipes is relatively low because of their simple structure. Thus, we discuss the possibility of using an underground aquifer as the storage element and underground pipes as the catchment and conduit for rainwater into the aquifer.

### STRUCTURE OF UNDERGROUND PIPES

**UNDERGROUND PIPES FOR IRRIGATION.** In trickle irrigation, underground irrigation is sometimes employed. In this method, water is supplied directly into the topsoil through permeable pipes of 4 to 7 cm diameter at a depth of 30 to 60 cm from the ground surface. The irrigation water percolates by capillary action to the root zone; and, from the view of irrigation, also uselessly percolates downward to recharge the groundwater lens. The rate of water applied to the plants is usually 1 to 3 mm/day per unit area. Clogging phenomena have not been reported for underground irrigation if the water is not contaminated.

UNDERGROUND PIPES FOR GROUNDWATER RECHARGE. As shown in Figure 1, three types of underground pipes were devised in the application of this method of groundwater recharge.

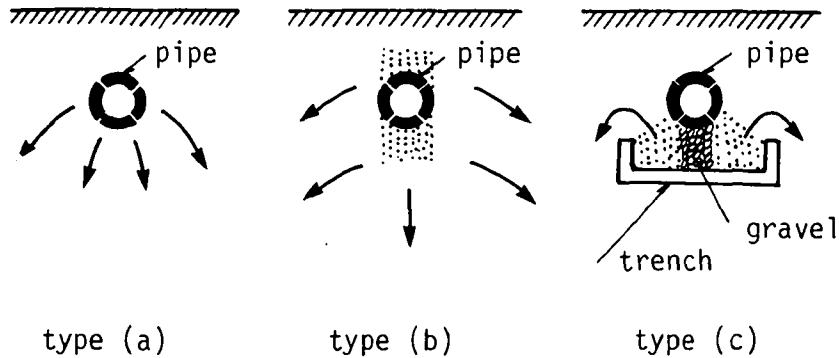

Figure 1. Three kinds of underground pipes

Type (a). In the case of type (a), pipes were installed underground. The structure of type (a) pipes is simple and a low-cost method developed for irrigation and drainage.

Type (b). For type (b), part of the area surrounding the pipe was replaced with highly porous sand or gravel to increase the infiltration rate and to provide a certain amount of storage capacity. The variation of rainfall intensities in a hyetograph can be smoothed by storage capacities. This type seems to be suitable for infiltration of rain water.

Type (c). For type (c), the pipe is placed in a trench. The water which is stored in the trench rises by capillary action to the topsoil. In this case, an aerobic condition is maintained and purification in the soil is expected. This type of pipe is useful when the water supplied is contaminated to a certain degree and clogging may occur.

Permeable Pipe. Pipes buried underground must be permeable and perforated with many small holes to be effective. Clay pipes of 1 to 2 m in length are useful if they are roughly connected so that water can pour out from the connection joints.

#### FIELD EXPERIMENTS OF UNDERGROUND PIPES

GEOLOGICAL DESCRIPTION OF A FIELD. Field experiments were conducted at Fukaya, Saitama Prefecture (50 km north of Tokyo as shown in Fig. 2). The field is located on an old alluvial fan of the Ara River. The slope of the ground is 1:100. The 5 to 6 m deep surface layer is comprised of Kantoh loam (Fig. 3), which is underlaid with a gravel stratum—20 m deep—of loam and clay. The particle-size distribution characteristics of the Kantoh loam is shown in Figure 4. The coefficients of permeability of the Kantoh loam have been tested in laboratory as  $0.5$  to  $5 \times 10^{-4}$  cm/s.

PRELIMINARY EXPERIMENT. Infiltration experiments were conducted (Fig. 5)

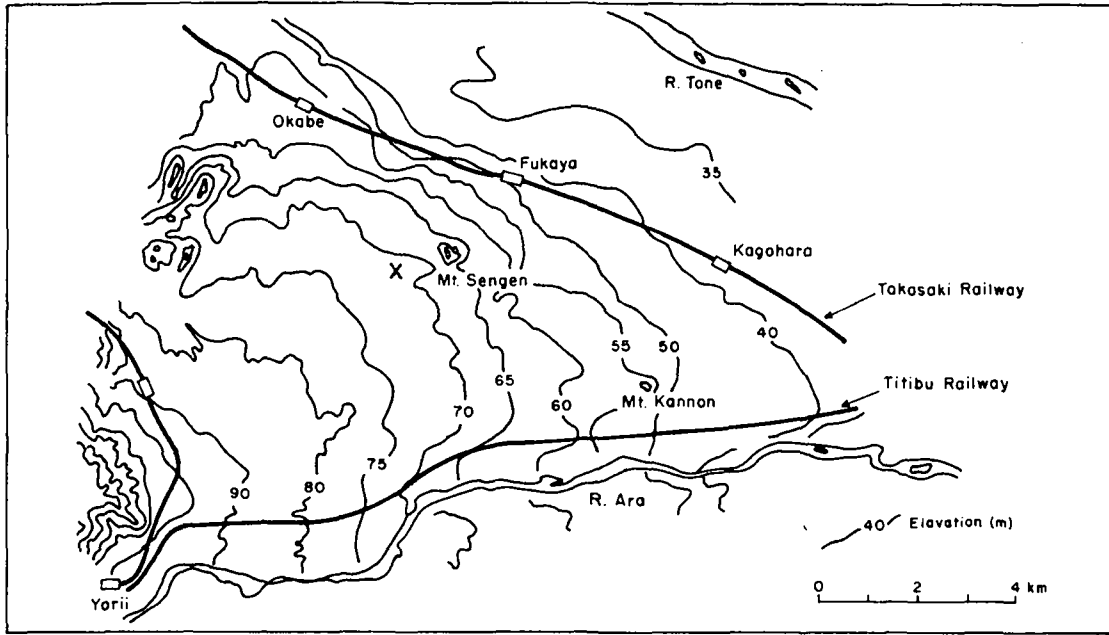

Figure 2. Field experiment site, Fukaya, Japan

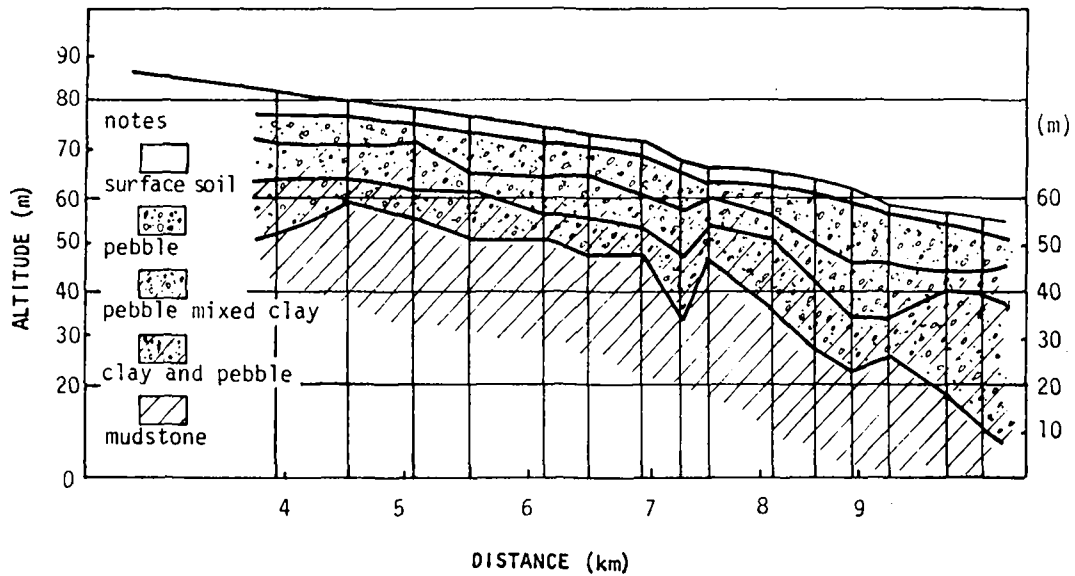

Figure 3. Geological sectional plan

in two fields. In Field A, the vicinity of type (a) pipes were refilled with the same soil; and in Field B, with coarse sand. For both fields pipe lengths were 10 m. Water supplied to the pipes was from the Ara River. In Figure 6 the results of the experiment are shown. The rates of infiltration through both pipes reached up to  $0.125 \text{ m}^3/\text{hr}\cdot\text{m}$  (per 1 m of pipe). Because the storage capacity for the replaced or refilled area is estimated to be about  $0.05 \text{ m}^3/\text{m}$  (per 1 m of pipe), most of the water supplied seemed to infiltrate directly underground.



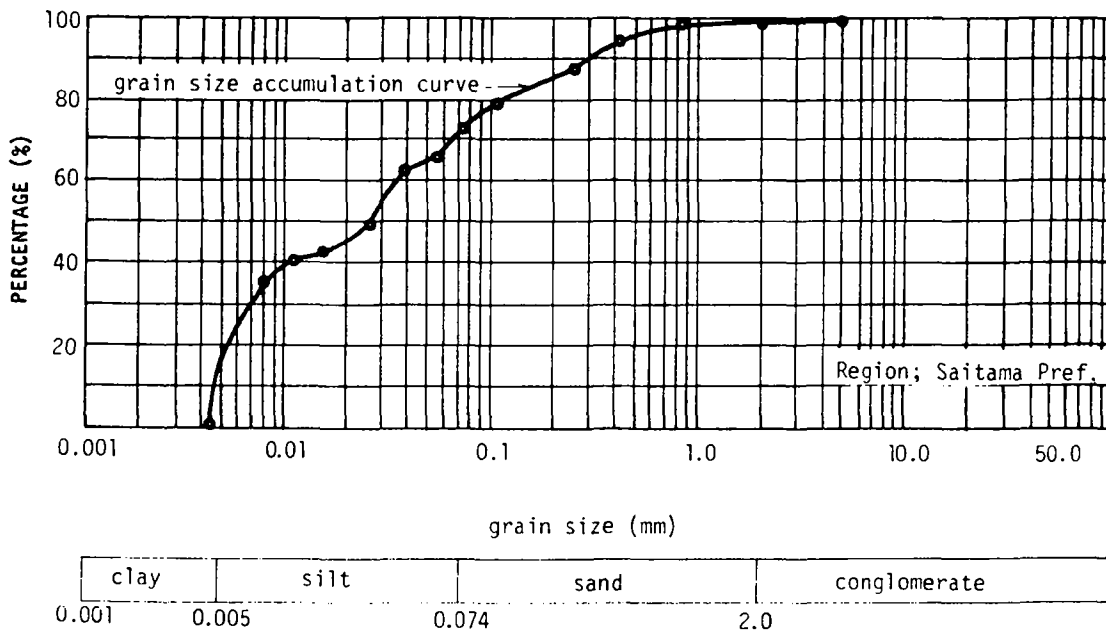

Figure 4. Soil characteristics of Kantoh loam

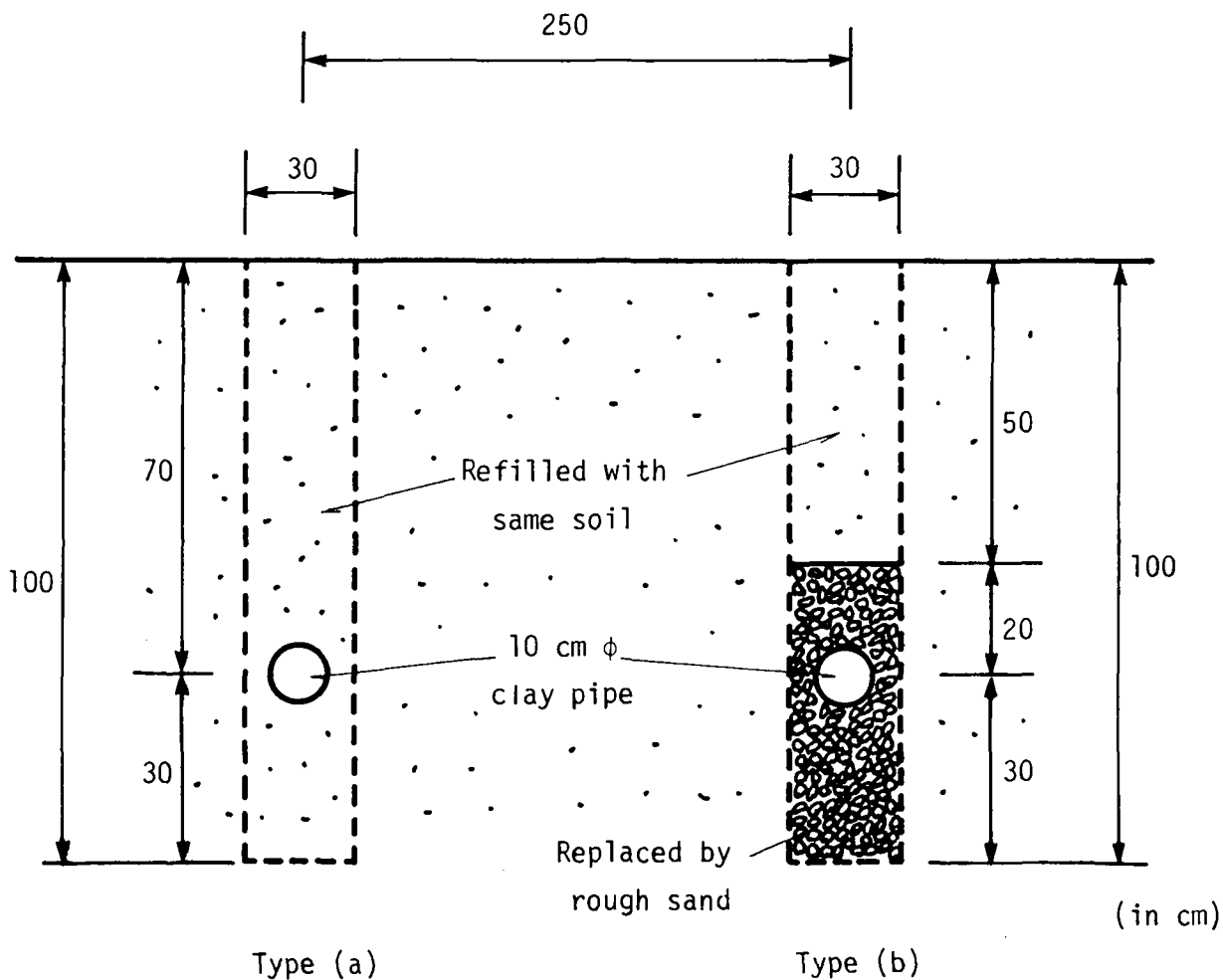

Figure 5. Structure of pipes in preliminary experiment

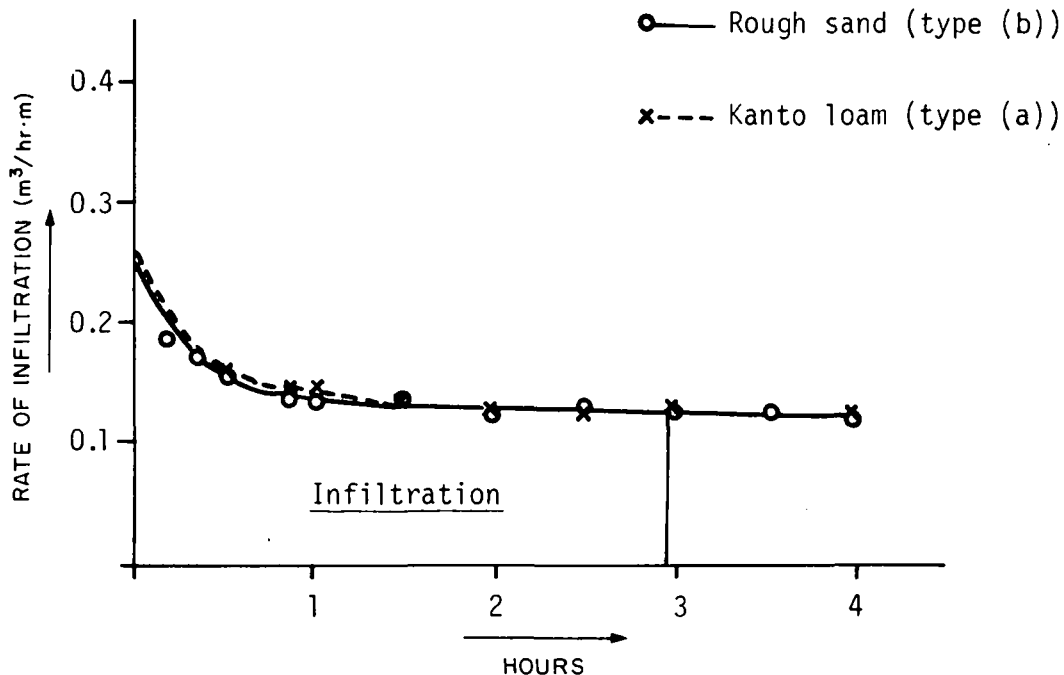

Figure 6. Infiltration rate in preliminary experiment

MAIN EXPERIMENTS. Main experiments were conducted in the same fields. Type (b) pipes were buried at 2.5-m intervals (Fig. 7). An experiment, which was carried out first for 24 hr, was aimed to observe how the infiltration rate decreases as time passed (Fig. 8). As shown in the figure, the infiltration rate reached a constant value after 3 hr and did not change for the rest of the duration of the experiment.

The constant rate of infiltration was  $0.150 \text{ m}^3/\text{hr}\cdot\text{m}$  (per 1 m of pipe). As each pipe seems to have a 2.5 m wide infiltration area, the value of  $0.150 \text{ m}^3/\text{hr}\cdot\text{m}$  corresponds to  $0.150 \text{ m}^3/\text{hr}\cdot\text{m} \div 2.5 \text{ m} = 60 \text{ mm/hr}$  or  $= 1\,400 \text{ mm/day}$ . This value of infiltration rate is fairly large and seems to be in the same order as that of the recharge rate for ponds or basins. The value of  $60 \text{ mm/hr}$  also corresponds to  $1.7 \times 10^{-3} \text{ cm/s}$  of the permeability coefficient. This value, which is much larger than those tested in laboratories as mentioned above, can be explained by the presence of aggregates (peds), planar voids and turbular channels of natural field soils.

The experiment was then expanded to a duration of two years to observe if any clogging phenomena occur. Total water supplied to the field reached a volume of  $2\,277 \text{ m}^3$ , which corresponds to a total of  $22\,770 \text{ mm}$  and about  $56 \text{ mm/day}$ . The possible infiltration rate did not decrease in two years and clogging did not seem to occur.

INFLUENCE OF INFILTRATION ON PLANTS. Three kinds of vegetables (cabbage, taro, Welsh onion) were planted for infiltration experiments with underground pipes. There was no remarkable difference between the crops grown in the infiltration field from those in the natural field (Fig. 9).

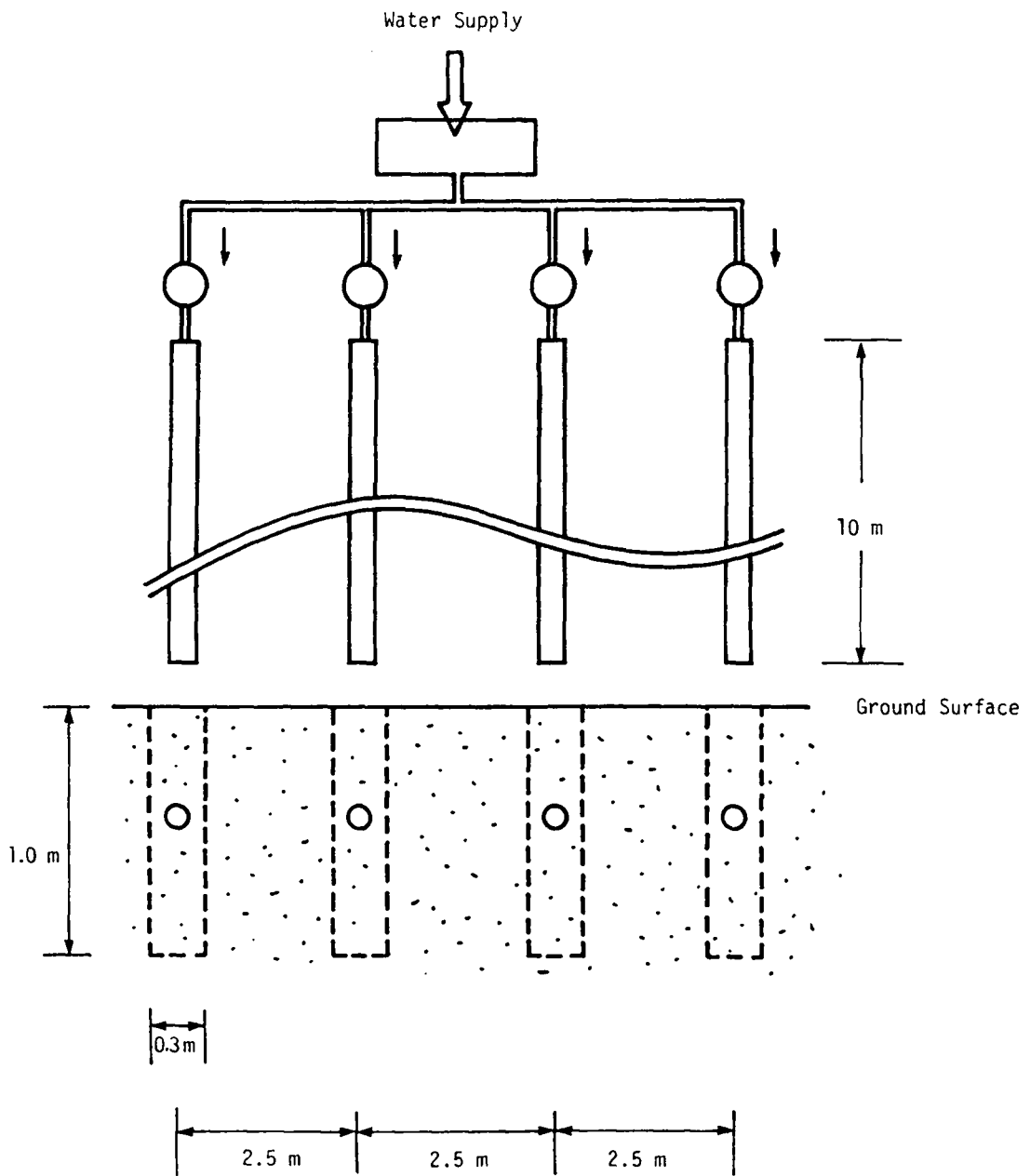

Figure 7. Infiltration systems of main experiment

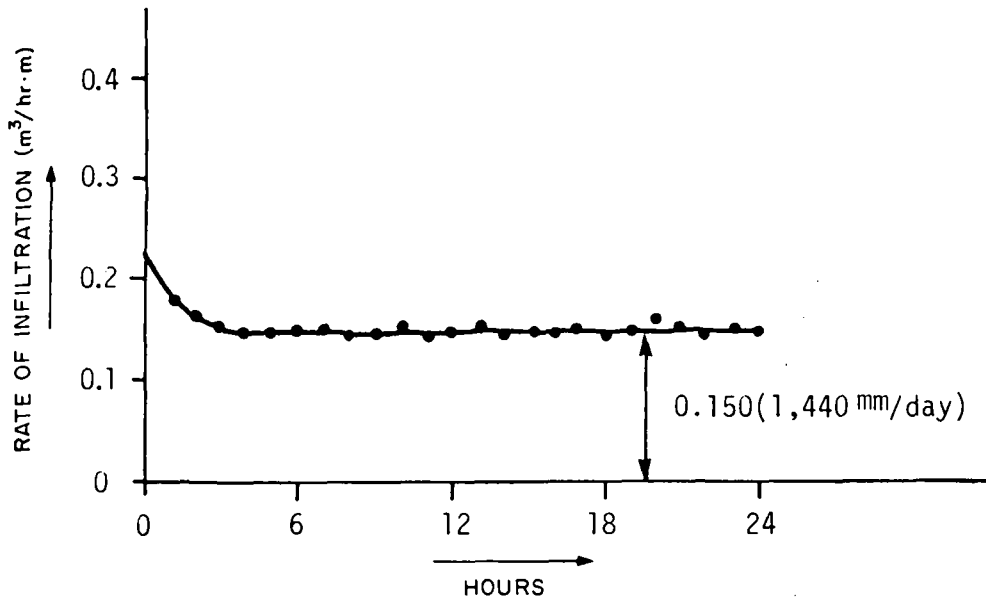
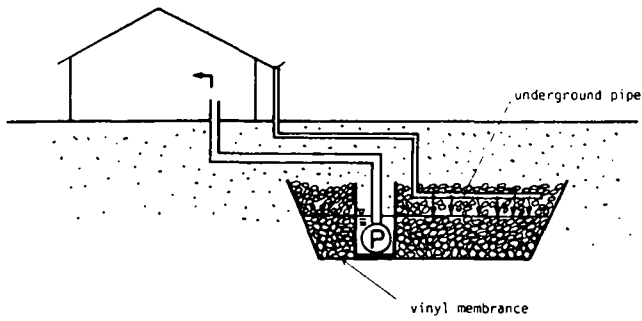

Figure 8. Infiltration rate in main experiments

Year	1978		1979			1980			Total (410 days)
Vegetable	Cabbage (135 days)		Taro (178 days)			Welsh onion (97 days)			
Block	Recharge	Crops	Recharge	Crops		Recharge	Crops		
Natural area	rainfall 215 mm	400 800 kg/a 688 kg/a	rainfall 907 mm	100 200 300 kg/a 190 kg/a		rainfall 465 mm	200 400 600 kg/a 506 kg/a		rainfall 1587 mm
Recharge area	rainfall 215 mm injection 1998 mm (15 mm/day)	692 kg/a	rainfall 907 mm injection 13871 mm (78 mm/day)	180 kg/a		rainfall 465 mm injection 6904 mm (71 mm/day)	435 kg/a		rainfall 1587 mm injection 22773 mm (56 mm/day)

Figure 9. Total volume of rainfall and artificial infiltration and its effects on field crops



10.1. Type A

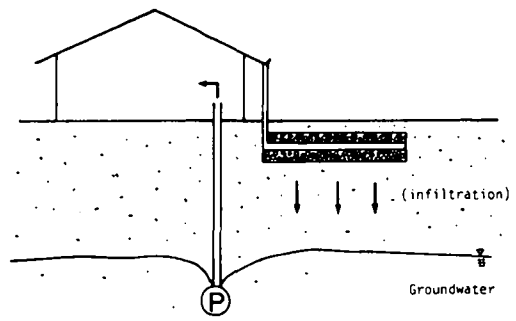

10.2. Type N

Figure 10. Rain water cistern system using Types N and A underground aquifers

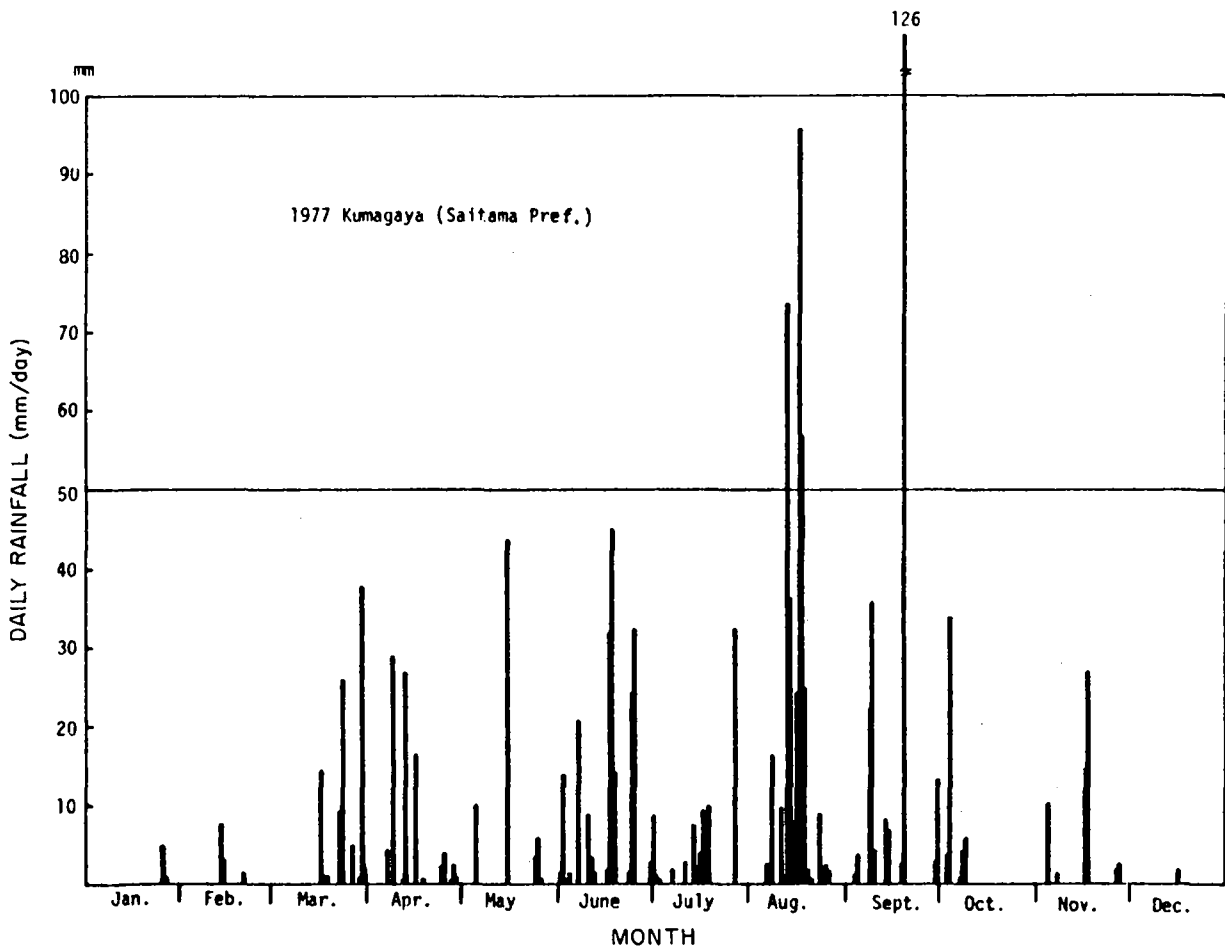

Figure 11. Rainfall data used in the estimation

## ESTIMATION OF WATER TO BE DEVELOPED

RAINWATER CISTERN SYSTEMS USING UNDERGROUND AQUIFERS. A rainwater cistern system which uses an underground aquifer for storage was planned as illustrated in Figure 10. In the case of Type (N), the natural underground aquifer is used instead of storage tanks. In the case of Type (A), an artificial, vinyl-membrane aquifer of sand or gravel is used instead of a storage tank. The amount of water that can be developed by these systems are decided by the following factors: (1) rainfall characteristics, (2) infiltration capacity, and (3) storage capacity of the aquifer.

Rainfall characteristics consist of rainfall data of the site for which rainwater cistern systems are designed. The infiltration capacity is determined by the permeability of the soil and the length of pipes buried. And the storage capacities should be large enough so that the amount of water to be developed is only dependent on the infiltration capacity of the pipes. Should artificial aquifers be used for the storage of rain water, the amount of water to be developed is dependent only on infiltration capacities of pipes but also on the storage capacity of the artificial aquifer.

CASE STUDY. The amount of water to be developed and rainfall data (Fig. 11) is estimated based on the following conditions:

- Area of roof =  $100 \text{ m}^2$
- Length of pipe = 10 m
- Rate of infiltration/1 m of pipe =  $0.15 \text{ m}^3/\text{hr}\cdot\text{m}$
- Volume of artificial aquifer =  $40 \text{ m}^3$
- Porosity of artificial aquifer = 0.25
- Storage capacity of artificial aquifer =  $10 \text{ m}^3$ .

By using Figure 12, the amount of water to be developed is estimated to be about 140 l/day.

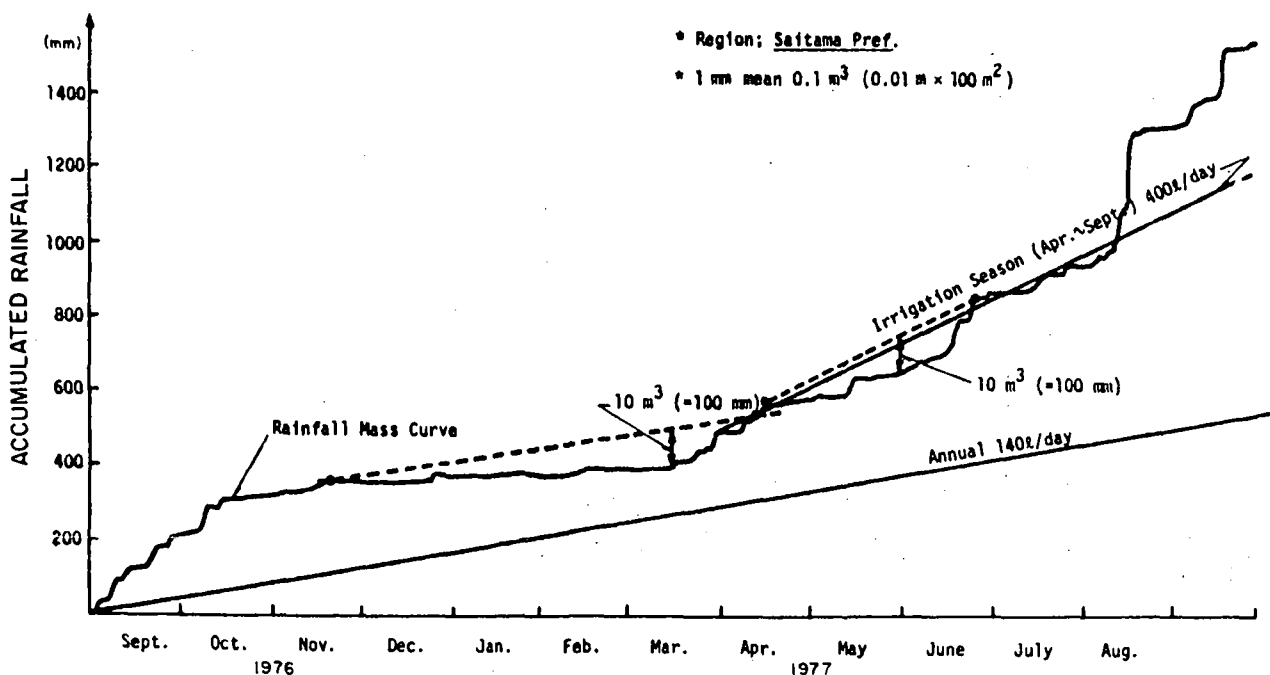

Figure 12. Estimation of the amount of water to be developed

## REFERENCES

- Ishizaki, K., and Kitagawa, A. 1981. A study on artificial recharge by recharge wells. Rep. No. 155, Public Works Research Institute, Ministry of Construction, Ibaraki Prefecture, Japan.
- \_\_\_\_\_, and Kitagawa, A. 1982. "Artificial groundwater recharge by underground pipes." Public Works Research Institute, Ministry of Construction, Ibaraki Prefecture, Japan.

## RAIN WATER CISTERN SYSTEMS IN CHINA

Jiaxiang Zheng, Associate Professor  
Department of Geography  
East China Normal University  
Shanghai, CHINA

## INTRODUCTION

Rain catchment systems have long been used in China. People like to drink rain water because it is cleaner than river or well water and does not have the bad odor and taste of river or well water.

In the vast area south of the Yangtze where rainfall is abundant, rain water cistern systems have been a common means of water supply in past years.

The method of collecting and storing rain water was rather simple. The most available material that people used for making rain water gutters was mao bamboo, which is very common in South China and has a thick stem, which can be hallowed out and split into two halves for use as gutters. Since the introduction of tin plate and galvanized iron, people have liked to use them instead of bamboo for making gutter systems, although they are susceptible to rusting and are more expensive. Earthenware, a traditional material used for making vessels in China, is also available for making rain water cisterns. People use large earthenware vats as storage cisterns. The vats have various sizes, but the largest one has a volume of about one cubic meter. In appearance it is like a bowl, with an upper diameter of about one meter or more. Although earthenware is fragile, it is an ideal material for a rain water cistern because it is less expensive and has no effect on water quality.

In rural areas of China, an ordinary household usually has a small yard where large earthen vats used as rain water cisterns are placed just under the gutter systems to receive the rain water from above. When it rains and the vats are filled with water, wooden covers are put on them to avoid contamination and to shut out the sunlight to prevent algae growths. No filtering process is needed, but some alum as coagulant is generally added to remove the suspended solids. The impurities on the bottom of the vat should be regularly cleared away. Because mosquito larvae sometimes breed in the water, a goldfish is placed in the water to feed on them.

In China, an average peasant may have a commodious house with a total roof area of 50 to 100 m<sup>2</sup>. As a catchment area, it is broad enough to receive rain water for drinking, but still inadequate to provide water for other domestic uses. Thus, river or well water must be used for washing and other domestic uses. Since the annual rainfall in subtropical and tropical areas of China generally exceeds 1 000 mm, and in many regions over 1 500 mm, most of the domestic demand for water can be very likely technically improved by using rain water cistern systems with larger catchment areas.

In recent years, tap water has become an increasingly common source of water in small cities and towns of China, while rain water cisterns have decreased. However, people do not like chlorinated water for drinking because



of its odor, and some people still collect rain water for drinking.

### RAINFALL PRECIPITATION

North China has an average annual precipitation of about 500 mm, with high seasonal variation and strong evaporation, so the use of rain water cistern systems is less likely there. Thus, it is necessary to make detailed investigations and experiments before evaluating the potential of using rain water cistern systems in those regions where it is well known that most people use well water.

### WATER POLLUTION

The population growth of China in the preceding three decades as well as the rising standard of living have contributed to the increase in water pollution and caused a disproportionate and unfavorable impact on the environment. For example, in step with the doubling of population, the amount of human waste is also doubled. The intensive farming that is essential to maintain high yields led to the overuse of nitrogen fertilizers and pesticides, which in turn have posed a serious problem of water pollution. Since the founding of the People's Republic, the development of industry has accelerated. In addition to large plants, many medium-sized and small factories have been built in the smaller cities and towns and even the vast rural areas; consequently, a number of unfavorable effects of pollution on the environment have resulted, one of which is that the quality of surface waters and groundwaters of vast rural areas has increasingly deteriorated. Lack of safe drinking water has become a new challenging problem in many areas of China, especially where the population is concentrated and surface waters are usually stagnant due to low and flat local terrains.

### CONCLUSIONS

The traditional rain water cistern system of China, which is technically simple, inexpensive, capable of local manufacture with locally-available materials, may serve as a feasible alternative to meet the urgent demand for safe drinking water.

As for rain water quality, no available data have been obtained yet, although a few water samples collected from the downtown area of Shanghai municipality indicated that there seemed to be no major problem of water quality for drinking, even though the air is heavily polluted.

At present in the overpopulated great urban centers of China where housing is in short supply and mainly of high buildings, rain water cistern systems seem less practical because the roof area for a catchment area is inadequate in relation to the concentrated population and needs for water. However, in the vast rural areas as well as small cities and towns where most of the Chinese people live, rain water cistern systems may serve as a reasonable device to solve some of the problems of water shortages.

## WATER DEMAND ANALYSIS FOR AGRICULTURAL WATERSHEDS

Prabhat K. Chowdhury, Research Fellow  
Department of Agricultural Engineering  
Indian Institute of Technology  
Kharagpur, WB 721302, INDIA

## INTRODUCTION

Agriculture cannot exist without water. And without the required quantity of water, especially during critical periods, agriculture fails. If farmers cultivate crops without a clear picture of the amount of water needed during the growth period, two problems can occur: either crop damage because of a water shortage or a decrease to some extent in net returns because of improper and underutilization of the available water.

Farmers sometimes grow a single crop, paddy, for example, on their entire land holding. If there is a shortage of water in such cases, it is possible to overcome the problem by planting some other crops, such as wheat and pulses, in addition to paddy during the same season without causing damage to the crops because of a water shortage or diminishing the net returns. One means of increasing the per capita income of farmers is the selection of the right combination of crops, whose water demands remain well within the available water resources during a given season and which result in maximum net returns and which fulfill food-grain requirements and yet remain within their investment potentialities. How and why water demand analysis is used for agricultural watersheds are dealt in detail in this paper and a water demand analysis case study is presented for small farmers.

## IMPORTANCE OF WATER DEMAND ANALYSIS

Water demand analysis (WDA) plays a key role in agricultural planning. For intensive and extensive agriculture, water, like seeds, fertilizer, insecticides and pesticides is an important factor. The optimum quantity of water applied at the proper crop stage and a deficit soil moisture content will increase crop yield, without limiting other crop attributes.

In Indian agriculture, experience has shown that an excess of water results in the same decreasing yield tendency as that of a water deficit, which is true for all crops with varying degrees. An excess of water or waterlogged soils reduces the oxygen intake by the roots and in the uptake of harmful salts from the deeper layers of the soil to the surface, i.e., the root zone. Because of the lack of proper aeration and the continuous waterlogging, the soil structure and, thereby, the hydraulic conductivity of the soil in the root zone is, in the long run, changed. A deficit soil moisture content develops excess stress on the root hairs in extracting plant nutrients from the soil in the root zone, and hampers in varying degrees the transmission of plant nutrients to various parts of the plant.

After several years of fertilizer application, the salt content of the root zone increases. Sometimes, saline and alkaline soils contain harmful

salts. To increase crop yield, these salts should be leached from the root zone to deeper soil layers. A deficit soil water content helps in increasing the soil salinity and alkalinity instead of leaching the salts to deeper layers. Thus, the optimum water demand for a particular type of soil and crop should be monthly and seasonally analyzed for profitable agriculture. Planning without WDA results in an excess or deficit of water.

#### SELECTION OF CROPPING PATTERN

Water demand analysis is based on the cropping pattern accepted for a given season. Several factors should be taken into consideration before choosing a particular cropping pattern, and all factors given due consideration. The following factors influence the selection of WDA cropping pattern.

**SOCIOECONOMIC BACKGROUND OF FARMERS.** The socioeconomic status of farmers plays an important role in rural agriculture in most developing countries. For example, a cropping pattern which demands heavy investments cannot be suggested to a farming community whose per capita income is below the poverty line. Thus, data on annual income, family size and landholding size of the farmers are collected and analyzed. Farmers possessing landholdings in the range of less than 1 ha, 1 to 2 ha, 2 to 5 ha and above 5 ha are grouped respectively under marginal, small, medium and wealthy farmers. These four groups have different capacities of investing land, labor and capital for agriculture. Depending on the category of farmers, cropping patterns are suggested.

**BASIC (FAMILY) REQUIREMENTS.** In rural areas, small and medium farm owners have some basic family requirements, such as, daily food sustenance, fiber for clothing, fodder for cattle, and some cash in hand for educating his children and maintaining the family. Basic food grains consumed by Indians are rice, wheat, maize, sorghum, bajra and ragi, which are, therefore, the major crops grown by farmers whether he is a small or wealthy farmer. Then, other crops grown include pulses (green gram, black gram, arhar, beans, kulthi), vegetables (potato, tomato, brinjal, cabbage, cauliflower, knol-khol, ridge- and bitter-gourds), fruits (mango, apple, orange, coconut, citrus, and many others). In addition, other crops include groundnut, cashew nuts, gingelly, mustard, castor, sunflower, safflower, sugarcane, jute, cotton, tea, coffee, tobacco, and condiments and spices as commercial crops. The crops providing carbohydrates, proteins, fats and other vitamins form the essential crops. The psychology of the rural farmers is to first grow the essential crops, rather than some single crop giving maximum net return. Thus, it is on the basis of priority that the cropping pattern is selected.

**SOIL AND WEATHER CONSTRAINTS.** The selection of crops is based on climatological data (length of daily sunlight hours, humidity, mean daily temperature, rainfall pattern) and soil properties (light or heavy soils; upland, medium land, lowland; sand, silt and clay content; shallow or deep soil; alluvial, arid, semiarid and coastal). The crops best suited for the regional climate and soil types are sorted out first irrespective of all other factors influencing the selection of cropping patterns. From among these crops only are formed the feasible cropping patterns. Thus, soil map and climatological data of the region under consideration are consulted in sorting out the crops best suited for the region.

**ASSESSMENT OF AVAILABLE WATER.** Various water sources may be grouped under (1) surface water, (2) subsurface water and (3) underground water. Surface water includes rain water; river or canal discharge; pond, reservoir and lake water; glacier and sea water after desalination. Subsurface water constitutes springs and perched and unconfined aquifers close to the ground surface. Underground water which is also called groundwater includes mainly the water present in confined aquifers and in faults and fissures of bedrock.

**Groundwater.** The groundwater potential of the watershed can be estimated by conducting several pumping tests and by knowing the depth of confined aquifers, either from well logs or from geological maps of the watershed; hydraulic conductivity, storage coefficient, transmissibility, areal extent and the piezometric level of the aquifer.

**Subsurface Water.** In a similar way, the subsurface water potential can be estimated from the unconfined aquifers by consulting the geologic map of the watershed and the aquifer characteristics obtained from pumping tests conducted in the unconfined aquifers.

**Surface Water.** Rain water as a source of surface water is further assessed according to infiltration, evaporation; domestic, sewerage and recreational use; outflow to the ocean, and ice and snow. The net available rain water available for agriculture is the water stored in cisterns of an agricultural watershed, such as field plots and reservoirs; rivers, canals and lakes. In some low-lying areas, springs also contribute to the surface water.

Discharges from canals, rivers, reservoirs (whichever is applicable) are collected from previous records. The discharge from these sources in a particular season is forecasted, applying appropriate forecasting techniques, at about a 60% probability. The storage and the runoff components of the rain-storm for a network of interconnected plots are obtained by using runoff models. The volume of water stored in village ponds within the agricultural watershed is computed based on evapotranspiration and percolation losses during the given season. Thus, the net available surface water during a given season from all sources is obtained starting from canal discharge to village ponds.

Because the complete depletion of the groundwater or subsurface water is not advisable, only a certain percentage of the available groundwater and subsurface water is added to the available surface water to obtain the total quantity of water available for agriculture for a given season. In countries where sweet water is scarce and the cost of desalination is reasonable, a portion of the available water for agriculture is obtained from desalting sea water in coastal regions.

**FEASIBLE CROPPING PATTERNS.** After sorting out the crops best suited for the regional soil and climate as explained earlier, a crop calendar is prepared (Table 1). For each crop there is an optimum period of sowing. Yield reduces when sowing is delayed or done earlier than the sowing period. The crop duration and water requirements (Chaudhry 1972) are collected. The crop calendar includes the periods from the date of sowing to the date of harvesting for each crop along with their seasonal water requirements (Table 1). From the crop calendar, crops are so combined that the sowing of one crop does not overlap with the harvesting or maturing of another crop if both crops are to

TABLE 1. CROP CALENDAR AND SEASONAL WATER REQUIREMENTS

CROP	MONTH													
	Jan.	Feb.	Mar.	Apr.	May	June	July	Aug.	Sept.	Oct.	Nov.	Dec.		
	I II		I II		I II		I II		I II		I II			
Khariif paddy*													←----- 150 days 1.524 m -----→	
Wheat	←-----												←----- 120 days 0.356 m -----→	
Jute													←----- 130 days 0.457 m -----→	
Potatoes	←-->												←----- 110 days 0.635 m -----→	
Mustard & Veg.	←-->												←----- 110 days 0.306 m -----→	
Boro paddy†	←-----												←----- 130 days 1.143 m -----→	↔
Aus paddy‡													←----- 120 days 1.016 m -----→	
Maize													←----- 110 days 0.457 m -----→	←----- 110 days 0.457 m -----→
Pulses (Mung)	←-->												←----- 90 days 0.152 m -----→	
Peas	←-->												←----- 100 days 0.203 m -----→	

\*Monsoon.

†Winter.

‡Summer.

be cultivated in the same plot. Crops are mostly combined to cover the field throughout the year. Some portion of the land is sometimes kept fallow according to the need; sometimes, the harvesting and sowing of two crops may overlap, in which case seedlings can be raised in separate nurseries. These crop combinations are called cropping patterns. For example, (kharif paddy)-(wheat)-(jute) indicate that these crops can be respectively grown during the monsoon, rabi and summer seasons. A (kharif paddy)-(wheat + potato + fallow)-(jute + summer paddy) cropping pattern indicates that (1) kharif paddy is grown in the entire land holding during the monsoon season; (2) during the rabi (winter) season, wheat is allocated to a portion of the land, a portion is set aside for potato and no crop is grown in the remaining portion of the land holding; (3) during the summer season, a portion of the land is planted in jute and the remaining portion in summer paddy. A portion of the land holding is kept fallow during a particular season for several reasons: lack of water, overlapping of sowing time of the following crop, shortage of farm laborers, lack of capital and crop disease control. Thus, a cropping scheme includes all these factors.

The crops included in the cropping pattern scheme vary between the size of the landholding and the financial capability of the farmer as discussed

earlier. Thus, although best suited for the agroclimatic conditions of the region, some crops included in the cropping pattern scheme are not grown, depending on the socioeconomic status of the farmers for whom the WDA is designed. Thus, the feasible cropping pattern combinations are far less for farmers with small landholdings in comparison to those with larger holdings and greater wealth. When water is a limiting factor, the cropping patterns are selected on a priority basis and on the basis (family requirement). When water is abundantly available, additional crops are tried with the priority crops to increase the net returns. Based on an optimization technique, cropping patterns which result in maximum net returns and which fulfill basic requirements are finally selected.

#### AREA AND WATER ALLOCATION

The percentage of landholdings to be allocated and the quantity and sources of water to be applied to each crop are determined by an area-and-water-allocation model. Parameters, such as area and quantity of water—including a given set of constraints, are optimized in this model which maximizes the net returns. Simple to sophisticated land-and-water allocation models are available due to modern high-speed computers. A brief presentation of the area-and-water-allocation model is presented here.

Let  $A_N$  equal the net cultivatable area,  $A$  the crop allocation area,  $W$  the seasonal water allocation for a crop/unit area,  $Y$  the yield/unit area,  $P$  the harvested crop unit price,  $I$  the investment/unit area,  $n$  the total number of crops harvested in a given season and  $m$  the total number of seasons to grow the crops. The objective function (net return),  $F$ , to be maximized is

$$F = \sum_{j=1}^m \sum_{i=1}^n (A_{ij} \cdot Y_{ij} \cdot P_{ij} - A_{ij} \cdot I_{ij}) \quad (1)$$

here  $i$  and  $j$  indicate the  $i$ th crop grown during the  $j$ th season subject to

$$\sum_{i=1}^n A_{ij} \leq A_N \text{ for all } j$$

$$A_{ij} \leq A_N \text{ for all } i \text{ and all } j$$

$W_{ij}$  = seasonal water requirement of the  $i$ th crop in  $j$ th season

$$\sum_{i=1}^n A_{ij} W_{ij} \leq \text{seasonal net available water from all sources for all } j$$

$$\sum_{j=1}^m A_{ij} Y_{ij} \geq \text{yearly requirement of the } i\text{th crop} \leq \sum_{j=1}^m A_N Y_{ij} \text{ for all } i.$$

The non-negative constraints are

$$A_{ij} \geq 0, W_{ij} \geq 0, P_{ij} \geq 0, Y_{ij} \geq 0 \text{ and } I_{ij} \geq 0.$$

By linear programming,  $A_{ij}$  and  $W_{ij}$  are obtained for  $i = 1, 2, \dots, n$  and  $j = 1, 2, \dots, m$ .

#### WATER DEMAND AND IRRIGATION SCHEDULING

Although the consumptive water use of a crop is fixed, its actual water

requirement varies from soil to soil depending on porosity. The water requirement of a crop is not known for a given soil—can be obtained by using a simple formula such as that proposed by Blaney and Criddle (1950) in which

$$E_t = 2.54 \times 10^{-4} \sum_{i=1}^L c_i p_i (1.8 t_i + 32) \quad (2)$$

where

- $E_t$  = consumptive water use by the crop for  $L$  months, in m  
 $c_i$  = monthly consumptive use coefficient  
 $L$  = life span of a crop, in month  
 $p_i$  = daylight hours of the month expressed as percentage of daylight hours of the year  
 $t_i$  = mean monthly temperature, in °C.

After determining the daily consumptive use, average root growth of the crop, bulk density, average moisture content of the root zone soil and allowable percent depletion, irrigation intervals are computed. Example 1 is a sample calculation for irrigation scheduling. Equations (3) and (4) are used to calculate respectively the moisture deficit and available depth of water to the plant.

$$M_d = \frac{F_c - M_c}{100} B \cdot R_d \quad (3)$$

where

- $M_d$  = moisture deficit, in m  
 $F_c$  = field capacity, in %  
 $M_c$  = moisture content, in %  
 $B$  = bulk density of the root zone soil  
 $R_d$  = root zone depth on the day of the study, in m

and

$$A_d = \frac{R_d \bar{p} A_s}{100} \quad (4)$$

where

- $A_d$  = available depth of water at the time of study, in m  
 $\bar{p}$  = moisture content, in %  
 $R_d$  = root zone depth, in m  
 $A_s$  = apparent specific gravity of the root zone soil.

EXAMPLE 1. For a given region during the potato growing season (November, December, January), the mean monthly temperatures are respectively 25.7, 20.3 and 18.5°C. The percentage of daylight hours obtained from the U.S. Weather Bureau's "Sunshine Tables" for these three months are respectively 7.49, 7.54 and 7.64. The consumptive use coefficient for potato may be taken as 0.7. The root zone development for potato averages 0.25 m/mo for a soil having an apparent specific gravity of 1.5 and available moisture content of 10% by weight. Irrigation should be applied at 50% moisture depletion. The irrigation interval and necessary pump size to cover a 20-ha area at 60% overall irrigation efficiency must be computed.

SOLUTION. Based on irrigation intervals, crop area, actual depth of water to be applied and working hours of the pump from irrigation scheduling data (see Table 2), the required pump size is determined as follows:

November

$$\text{Area to be irrigated/day} = 20 \div 5 = 4 \text{ ha}$$

Volume of water to be applied =  $4 \times 3.125 \times 10^{-2}$  ha-m

Working hours of pump = 10 hr/day

Required pump size =  $(0.125 \times 10^4)/(10 \times 3600) = 0.035$  m<sup>3</sup>/s

December

Area to be irrigated/day =  $20 \div 13$  ha

Volume of water to be applied =  $20 \div 13 \times 6.25 \times 10^{-2}$  ha-m

Required pump size =  $(20 \times 6.25 \times 10^{-2} \times 10^4)/(13 \times 10 \times 3600) = 0.0267$  m<sup>3</sup>/s.

January

Area to be irrigated/day =  $20 \div 20$  ha

Volume of water to be applied =  $20 \div 20 \times 9.375 \times 10^{-2}$  ha-m

Required pump size =  $(20 \times 9.375 \times 10^{-2} \times 10^4)/(20 \times 10 \times 3600) = 0.026$  m<sup>3</sup>/s.

Therefore, the required pump size = 0.035 m<sup>3</sup>/s.

TABLE 2. IRRIGATION SCHEDULING

	November	December	January
Temperature, °C	25.7	20.3	18.5
Daylight hours, %	7.49	7.54	7.64
Crop coefficient	0.7	0.7	0.7
Consumptive use/day, $\times 10^{-2}$ m	0.347	0.296	0.286
Root zone depth, $\times 10^{-2}$ m	0.25	0.50	0.75
Depth of available water, $\times 10^{-2}$ m	3.75	7.50	11.25
Depth of available water to be applied, $\times 10^{-2}$ m	1.875	3.750	5.625
Actual depth of water to be applied, $\times 10^{-2}$ m	3.125	6.250	9.375
Irrigation interval, days	5.397	12.652	19.658
Irrigation dates	1, 6, 11, 16, 21, 26	1, 14, 27	9, 29
Required pump size, m <sup>3</sup> /s	0.035	0.027	0.026

#### CASE STUDY

A study conducted by the author in a group of villages in Debra block, district of Midnapore, in West Bengal revealed that landless agricultural laborers and marginal and small farmers constitute respectively 23, 37 and 19% of the total farming community. Thus, this WDA study is presented for small farmers of this region.

In Debra block, the groundwater potential is quite good, and a group of small farmers can afford to have a bamboo tube well with discharge rates ranging from 0.0043 to 0.0085 m<sup>3</sup>/s. Thus, the area and water available for small farmers averages respectively 1.5 ha and 0.0064 m<sup>3</sup>/s. Rainfall patterns and the geometry of the watershed are quite suitable for kharif paddy crops. If needed, water may be supplied from the tube well. Thus, a WDA is necessary only for the rabi and summer seasons.



Paddy, wheat, jute, potato, mustard, vegetables and pulses are crops that the small farmers can afford to grow. This selection is based on the investment per unit area needed to grow each crop. These crops are also selected on a priority basis since rice is the favorite food grain of the region, followed by wheat. The latter crop uses less water and, at the same time, is cheaper than paddy. Jute is a cash crop and is used partly for domestic purposes. Vegetables, pulses, potato and mustard—in addition to paddy and wheat—help in meeting the calorie requirements of the family. The selected crops are well suited to the soil and climatic conditions of the region.

For the chosen crops, a crop calendar as shown in Table 1 was prepared. Of the several cropping patterns, only three will be considered: (1) (kharif paddy)-(wheat + potato + vegetables + pulses)-(summer paddy + jute), (2) (kharif paddy)-(wheat + potato + mustard + pulses)-(summer paddy + jute + maize) and (3) (kharif paddy)-(wheat + boro paddy + pulses)-(summer paddy + jute). The crops enclosed within parentheses correspond to a particular season and the "+" sign indicates that the entire land holding is planted in the crops within the parentheses. One crop within parentheses indicates that only a single crop is grown during that particular season.

In the case of boro paddy cultivation, whose water demand is highest during the rabi (winter) season in the selected cropping pattern, compute the available water from the tube well during that season at the rate of 15 hr/day of a pumping for a 130-day period as

$$(0.0056 \times 15 \times 3600 \times 130 \times 100)/(10,000 \times 100) = 3.913 \text{ 2 ha-m.}$$

If the tube well is shared by two farmers, the available water and time of pumping per farmer is respectively 1.956 6 ha-m and 7.5 hr. Using the seasonal water requirement of boro paddy cultivation from Table 1, the maximum possible water demand of the rabi season is 1.714 5 ha-m for the entire landholding of the small farmer. This shows that no risk (as far as water is concerned) is involved for either the rabi season or the summer or kharif seasons as the water demand of the crop (boro paddy)—with its maximum water demand—has been met. It should be noted that this is a very special case not easily met in the case of large watersheds for which the water allocation must be based on an optimization model to avoid risk.

Today, the area allocation and net returns are precisely computed for each cropping pattern. The yield of a crop depends on its variety, amount of fertilizer application, and the quantity and time of application of water. Grain requirements of each crop depend on the size of the particular family for whom crop patterns are planned. Thus, the yield and yearly grain requirement of each crop have not been specified in the subsequent section of the case study.

**CROPPING PATTERN 1.** Using the notations described earlier, the area and water allocation is determined as follows. Let  $C_i$  denote the rice, wheat, vegetable, pulse, jute, mustard and maize crops respectively for  $i = 1, 2, 3, 4, 5, 6, 7$  and  $8$ . For cropping pattern 1, the objective function,  $F$ , to be maximized is

$$F = (1.5 Y_{11}P_{11} - 1.5 I_{11}) + \sum_{i=2}^5 (A_{i2}Y_{i2}P_{i2} - A_{i2}I_{i2}) + (A_{13}Y_{13}P_{13} + A_{63}Y_{63}P_{63} - A_{13}I_{13} - A_{63}I_{63}) \quad (5)$$

$Y_{ij}$ ,  $P_{ij}$  and  $I_{ij}$  are known from the variety of crop and other yield attributes, local unit price and labor charges for each  $i$  and  $j$ , and subject to

$$\sum_{i=1}^n A_{ij} \leq 1.5 \text{ ha}, A_{ij} \leq 1.5 \text{ ha for all } i \text{ and } j$$

$$(A_{11}Y_{11} + A_{13}Y_{13}) \geq YPR \leq (1.5 Y_{11} + 1.5 Y_{13}); A_{22}Y_{22} \geq YWR \leq 1.5 Y_{22};$$

$$A_{32}Y_{32} \geq YPtR \leq 1.5 Y_{32}; A_{42}Y_{42} \geq YVR \leq 1.5 Y_{42};$$

$$A_{52}Y_{52} \geq YPsR \leq 1.5 Y_{52}; A_{63}Y_{63} \geq YJR \leq 1.5 Y_{63}$$

$$1.5 W_{11} \leq 1.9566 \text{ ha-m} + \text{effective rainfall (ha-m) during monsoon}$$

$$\sum_{i=2}^5 A_{i2}W_{i2} \leq 1.9566 \text{ ha-m}; A_{13}W_{13} + A_{63}W_{63} \leq 85\% \text{ of } 1.9566 \text{ ha-m};$$

$$W_{11} = 1.524 \text{ m}; W_{22} = 0.356 \text{ m}; W_{32} = 0.635 \text{ m};$$

$$W_{42} = 0.306 \text{ m}; W_{52} = 0.203 \text{ m}; W_{13} = 1.016 \text{ m};$$

$$W_{63} = 0.457 \text{ m}.$$

Where  $YPR$ ,  $YWR$ ,  $YPtR$ ,  $YVR$ ,  $YPsR$  and  $YJR$  denote respectively the yearly requirement of harvested crops of paddy (rice), wheat, potato, vegetables, pulses and jute. Among the given constraints, the yearly requirements for each harvested crop should, if possible, be kept higher than the basic (calorie) needs so that the farmer can meet his family's needs and save some capital to meet future unexpected financial demands by selling the surplus harvest.

Using linear programming,  $A_{ij}$ ,  $W_{ij}$  and the net return are obtained. Of the three cropping patterns, the one giving the maximum net return is accepted, and  $A_{ij}$  and  $W_{ij}$  of the accepted cropping pattern will give the area and water demand for each crop and season. An irrigation scheduling chart is then prepared; and the seasonal crops grown are considered and the daily water demand, pumping requirement and pump size are determined. When water is not a constraint, the actual depth of water to be applied is calculated as shown in Table 2. When water is a constraint, the actual depth of water to be applied (Table 2, row 8) should not exceed the  $W_{ij}$  obtained from the area-and-water allocation model.

## DISCUSSION

For large watersheds, the available water from all sources are precisely calculated, which is not reflected in the case study. Crops requiring less water may be incorporated in cropping patterns when water is a limiting factor. More cash crops or off-season crops can be included in the cropping patterns to increase net returns when water is not a limiting factor. The optimization model should be modified according to the available resources and to local conditions.

## CONCLUSIONS

A suitable cropping pattern, optimization model and irrigation schedule should be geared to the socioeconomic background of the farmer. Based on these factors, the water demand for agricultural production can be analyzed and the same technique extended to agricultural watersheds—irrespective of their size—for maximum net returns and utilization of the available resources in the best possible way that does not involve any risk.

## ACKNOWLEDGMENT

The author is extremely thankful to Mrs. Faith N. Fujimura, Administrative Assistant/Editor, Water Resources Research Center, University of Hawaii at Manoa for editing the paper.

## REFERENCES

- Blaney, H.F., and Criddle, W.D. 1950. *Determining water requirements in irrigated areas from climatological and irrigation data*. SCS-TP 96, U.S. Department of Agriculture.
- Chaudhry, M.S. 1972. Water management practices for different cropping patterns in Orissa. In *Symposium on Cropping Patterns in India Proceedings*, pp. 520-527, Indian Council of Agricultural Research, at New Delhi, India, 27-31 January 1968.

## TRANSIENT MIXED-FLOW MODELS FOR STORM SEWER SYSTEMS

Charles C.S. Song, Professor  
St. Anthony Falls Hydraulic Laboratory  
Department of Civil & Mineral Engineering  
University of Minnesota  
Minneapolis, Minnesota 55414, USA

and

James Angus Cardle, Research Assistant  
St. Anthony Falls Hydraulic Laboratory  
University of Minnesota  
Minneapolis, Minnesota 55414, USA

## INTRODUCTION

The traditional role of a sewer network has been primarily that of conveyance of waste water and storm water. A common design criterion was to ensure an adequate hydraulic capacity to convey a maximum design flow at a steady rate without surcharging the sewer. The design objective and criterion of a sewer network have undergone a fundamental change in recent years due to upgraded pollution control rules. To meet these goals, it has become increasingly clear that a substantial saving can be achieved by utilizing the in-line storage capacity of a sewer network. Most existing sewer networks have enough capacity to store the entire runoff due to a storm equal to or less than the one-year storm. The majority of storm runoffs can thus be stored for future treatment if there are provisions for a suitable control mechanism or some precautions against transient pressure.

A sewer network designed to store as well as convey storm water would undergo changes in flow regimes following a large storm event. Typically, the flow would initially be free surface flow and then begin to pressurize starting at the downstream end of the sewer system. At this time there would be a combined flow regime consisting of free surface flow and pressurized flow separated by one or more moving surge fronts. The magnitude of such a surge may build up to a significant amount as it moves upstream, and would generate severe water-hammer pressure upon collision with an upstream boundary. Clearly, a steady state or a kinematic wave type model, such as the SWMM model, is not suitable for a sewer network used as a storage-conveyance system. A complete dynamic model capable of simulating unsteady mixed-flow is necessary.

This paper describes some experiences with two dynamic models: (1) the Priessmann-Cunge-Wagner model and (2) the Song-Cardle-Leung model developed at the St. Anthony Falls Hydraulic Laboratory.

## BASIC EQUATIONS

The equations of continuity and motion for one-dimensional unsteady flow in an open channel may be written as

$$\frac{\partial y}{\partial t} + v \frac{\partial y}{\partial x} + \frac{C^2}{g} \frac{\partial v}{\partial x} = 0 \quad (1)$$

and

$$g \frac{\partial y}{\partial x} + \frac{\partial v}{\partial t} + v \frac{\partial v}{\partial x} + g(S_f - S_o) = 0 \quad (2)$$

in which  $C$  is the gravity wave speed given by

$$C = \frac{gA}{T} \quad (3)$$

where  $y$  = depth,  $v$  = mean velocity,  $g$  = gravitational acceleration,  $A$  = cross-sectional area of flow,  $T$  = top width of flow,  $S_f$  = friction slope,  $S_o$  = bed slope,  $t$  = time, and  $x$  = distance measured along the channel. Equations (1) and (2) also describe one-dimensional flow in a closed conduit (pressurized flow) provided that  $y$  is regarded as the piezometric head measured from the pipe invert and  $C$  is replaced by the pressure wave speed,  $a$  (Chaudhry 1979); that is, any solution procedure applicable to the free surface flow regime is also applicable to the pressurized flow regime.

Hyperbolic differential equations, like equations (1) and (2), can be solved by a number of different numerical methods. The method of characteristics is perhaps the best known and simplest method for hyperbolic differential equations. Implicit methods may be the most economical for gradually varying flow because such methods are the most stable and allow large computational time steps. Because storm sewer flows are highly dynamic, involving surges and water-hammer, the method of characteristics appears more advantageous. For a detailed description of the method of characteristics, the reader may refer to Streeter and Wylie (1967). Briefly, the original differential equations, equations (1) and (2), are converted to the following two sets of ordinary differential equations:

$$\frac{dx}{dt} = v \pm C \quad (4)$$

$$\frac{dy}{dt} \pm \frac{C}{g} \frac{dv}{dt} \pm C(S_f - S_o) = 0. \quad (5)$$

When equations (4) and (5) are written in finite difference form, two simultaneous algebraic equations involving two unknown variables  $y_p$  and  $v_p$  at a point  $p$  in the  $(x, t)$  space are produced. Thus, the unknowns at any time step may be explicitly solved in terms of the known quantities at the previous time step.

In order for the characteristic method to be stable, it is necessary to satisfy the following criteria:

$$\text{for free surface flow, } \Delta t \leq \Delta x / |v \pm C| \quad (6)$$

$$\text{for pressurized flow, } \Delta t^1 \leq \Delta x / |v \pm a|. \quad (7)$$

If a constant  $\Delta x$  is used, equations (6) and (7) imply that different time steps must be used in the different flow regions.

## PRIESSMANN-CUNGE-WAGNER MODEL

To avoid the difficulties associated with the moving interface, Cunge and Wagner (1964) proposed a model based on Priessmann's suggestion in which a hypothetical slot (Fig. 1) is added to the pipe. The width of the hypothetical slot was determined such that the gravity wave speed  $C$ , calculated by equation (3), is equal to the pressure wave speed  $a$ , when the depth of the flow exceeds the diameter of the pipe. By converting the pressurized flow into an equivalent free surface flow, the entire mixed-flow system was modeled by a single set of equations.

At the St. Anthony Falls Hydraulic Laboratory, a model based on the Priessmann-Cunge-Wagner idea was constructed using the method of characteristics. It was found, however, that even this method required a special treatment of the interface, and lost some of its advantage when applied to a sewer system. This was because the moving pressurization wave, which is a point of discontinuity in the flow, usually became very steep shortly after its formation. This numerical scheme, which ignored the existence of the flow discontinuity, then became unstable. The numerical instability problem became progressively worse as the pressure wave speed or strength of the discontinuity was increased. Experience with modeling the proposed storage-conveyance system of Rochester, New York indicated that the pressure wave speed must be kept less than 60 m/s to ensure numerical stability, if the interface was not specially treated. Another problem associated with this model was its inability to tolerate negative pressure. During a highly dynamic mixed-flow phase, the significant amounts of water-hammer wave that exist may produce negative pressure. This model forces the pressure in the pressurized zone to stay equal to or above the pressure on the free surface.

## SONG-CARDLE-LEUNG MODEL

A basic and unique feature of this model is in its treatment of the interface. This model was first reported by Song (1976) and modified by Song, Leung, and Cardle (1979) and Song and Leung (1980). The latest and the most complete version of the interfacial boundary condition is described herein. A typical flow configuration at the interface is shown in Figure 2. A positive surge moving against the flow may develop a steep front, as shown, but a negative surge may have a very smooth interface. Even if the interface is smooth, the transition between the free-surface flow and the pressurized flow cannot be continuous because the gravity wave speed, as computed by equation (3), would be infinite at the point of transition where  $T = 0$ . For this reason it is always necessary to assume the existence of a discontinuity at the interface. As shown in Figure 2, there are a total of six unknown variables associated with the interface: they are  $y_1$ ,  $v_1$ ,  $y_2$ ,  $v_2$ ,  $w$  = speed of interface, and  $\ell$  = distance from interface to a neighboring station.

The shock fitting method, similar to that described by Cunge, Holly, and Verwey (1980) for surges in open channels, may be used to solve the six unknowns. The two shock conditions are the continuity equation,

$$(v_1 + w)A_1 = (v_2 + w)A_2, \quad (8)$$

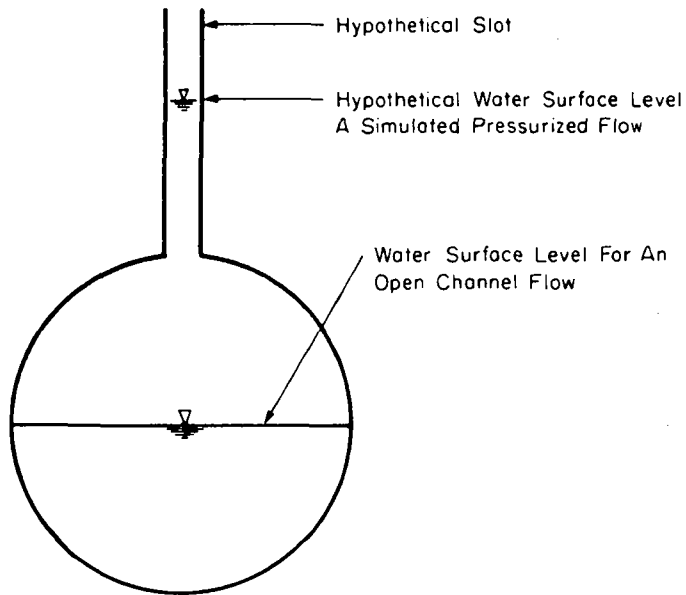

Figure 1. Schematic drawing showing the hypothetical slot of Priesman-Cunge-Wagner model

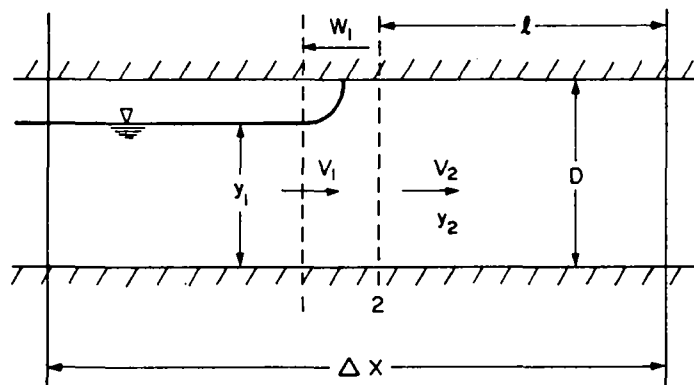

Figure 2. Flow near an interface for Song-Cardle-Leung model

and the momentum equation,

$$F_1 - F_2 = e(v_2 + w)A_2(v_2 - v_1) , \quad (9)$$

in which  $A_1$  and  $A_2$  are the cross-sectional areas of the flow and  $F_1$  and  $F_2$  are the forces due to hydrostatic pressure. The position of the interface is related to the wave speed by

$$\frac{dx}{dt} = w . \quad (10)$$

Clearly, the positive characteristic equation for Station 1 and the negative characteristic equation for Station 2 are applicable. The sixth equation needed must be the negative characteristic equation for Station 1 because of the physically reasonable condition,

$$a + v_2 > w > C_1 - v_1 . \quad (11)$$

According to the inequality (11), the positive characteristic line issuing from Station 2 would cut across the shock during the interval  $\Delta t$ . For this reason, the positive characteristic equation for Station 2 is not applicable.

The six equations stated above are solved by the Hewton-Raphson method. For the practical reasons stated previously, the solution must be subject to a constraint that

$$C \leq a \text{ or } D - y_1 \geq \epsilon \quad (12)$$

in which  $\epsilon$  is a preassigned value which will make  $C = a$ . If the solution to the six interfacial boundary conditions violates the above condition, then  $y_1$  is set equal to  $D - \epsilon$ , and the remaining five unknowns are solved by using the first five of the six equations.

There are a number of complicated problems which arise when the interface is located near some boundary, such as junction, a drop structure. These problems will not be presented herein due to lack of space.

## EXAMPLES

**PRESSURIZATION PROCESS.** The two models described above have been applied to a proposed new storage-conveyance sewer system for Rochester, New York. This is a free-shaped interceptor of diameter  $4 \sim 2.5$  m and length of about 30 km. It contains a number of drop structures, junctions, overflow relief structures, and surge relief structures. Except for a small amount of flow to be sent to the treatment plant, all the storm runoff must be first stored in the interceptor and the excess released as an uncontrolled overflow.

If the interceptor is nearly empty at the beginning of a large storm, the resulting flow will be initially of the slowly changing free-surface type. For a sufficiently large storm, the system will start to pressurize at the downstream end. Figure 3 shows a number of instantaneous hydraulic gradelines along the main tunnel during the pressurization period of a 2 yr design storm. It is possible to trace the movement of the pressurization surge by observing the hydraulic gradelines in sequence. Clearly, the flow at this stage is so dynamic that it can be adequately simulated only by a falling dynamic model.

**OSCILLATING SURGE AND WATER HAMMER.** As can be observed from Figure 3,



when the pressurization surge collides with an upstream end, a large magnitude pressure wave is reflected. Depending on the upstream end condition (with or without relief reservoir), a different magnitude water-hammer wave is generated. Figure 4 shows the head variation at an upstream end where a 3 m diameter dropshaft is located as computed with the PCW model using  $a = 60$  m/s. Very large amplitude water-hammer waves with a period of approximately 1.7 min is clearly noticeable in this figure. This natural period is equal to  $4L/a$  where  $L = 1.5$  km = the distance between the upstream end and the 11 m diameter surge relief tank located downstream. Less clearly noticeable is a smaller amplitude oscillation with a period of about 7 min. Figure 5 shows the head variation at the same upstream end when the surge relief structure is shifted to the upstream end. The water-hammer wave has disappeared and the surge with the 7-min period has become very obvious. This low frequency surge is believed to be due to oscillation between two neighboring reservoirs.

**STABILITY OF COMPUTATION.** The SCL model was found to be numerically very stable as long as the stability criterion given by equations (6) and (7) was strictly observed and no severe surge exists. The PCW model was found to be unstable when  $a > 60$  m. This instability was due to the steepness of the surge for large  $a$  and the model provided no shock fitting. The instability problem could not be removed by merely limiting the minimum head or by other numerical means. It remains to be seen if the shock fitting approach would stabilize the computation. Perhaps such instability problem exists for the SCL because the shock fitting condition is used.

### CONCLUSIONS

Two versions of mathematical models for transient mixed-flow have been introduced. The Priessmann-Cunge-Wagner type model is relatively simple if shock fitting is not provided; however, this model becomes numerically unstable when surges exist in the flow. The Song-Cardle-Leung model with shock fitting is more complicated, but much more computationally stable. A sewer system designed to store as well as convey water requires a fully dynamic model, such as the SCL model, because surges and water hammer occur in such a system.

### ACKNOWLEDGMENT

This paper is based in part on the research works sponsored by Lozier Engineers and Lozier-Seelye-Torias Inc., Rochester, New York and the Department of Engineering, Monroe County, New York whose support is greatly appreciated.

### REFERENCES

- Chaudhry, M.H. 1979. Applied hydraulic transients. New York: Van Nostrand Reinhold.
- Cunge, J.A.; Holly, F.M.; and Verwey, A. 1980. Practical aspects of computational river hydraulics. Boston: Pitman Publishing.

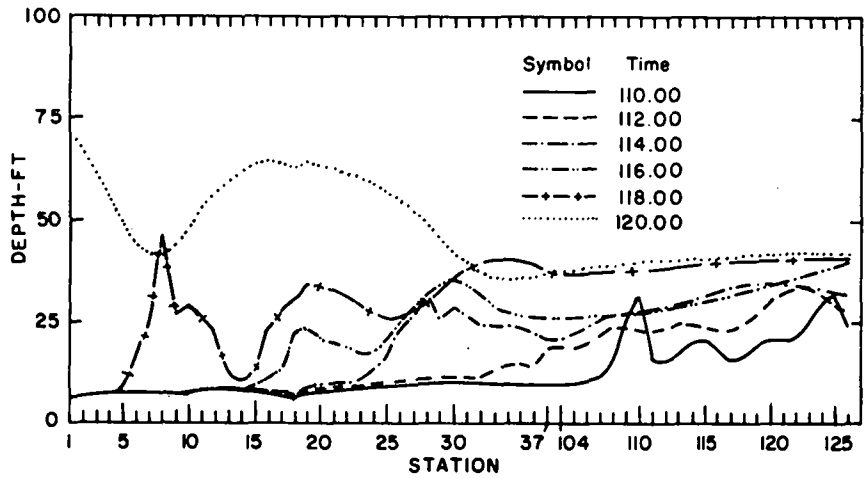

Figure 3. Hydraulic grade-lines during pressurization showing the formation of surge

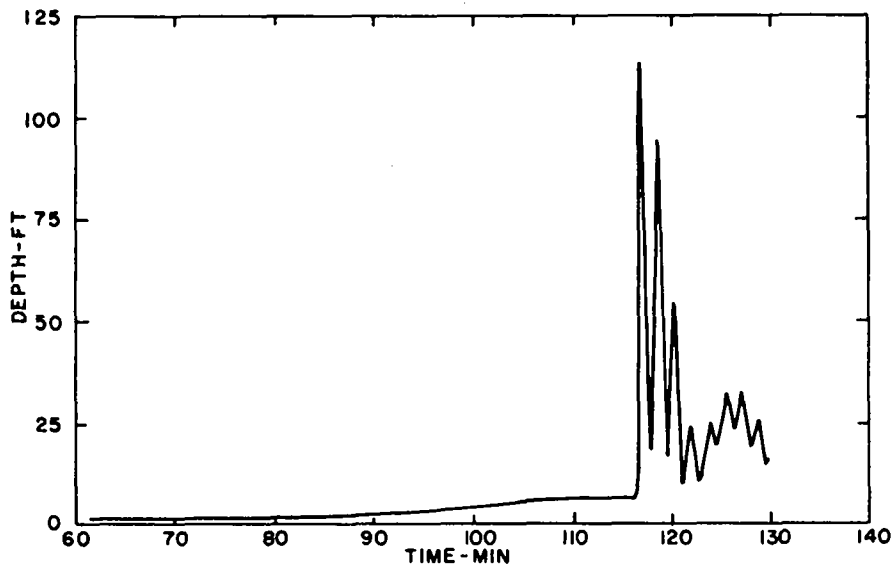

Figure 4. Waterhammer pressure oscillation due to surge colliding with an upstream end

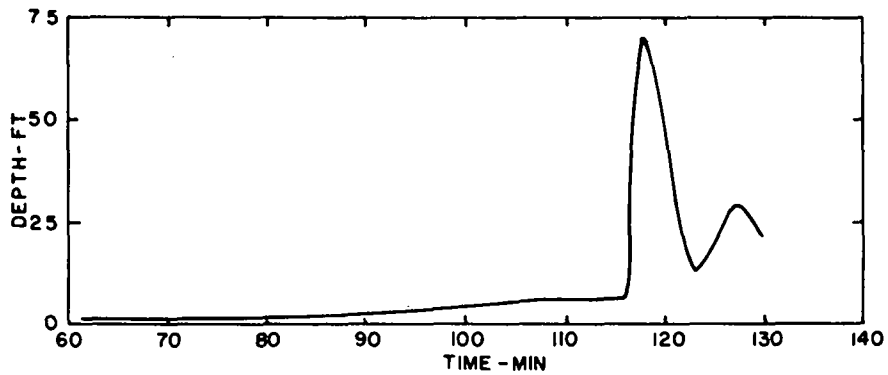

Figure 5. Pressure oscillation due to surge between two reservoirs

- Cunge, J.A., and Wagner, M. 1964. Numerical integration of Bane de Saint-Venant's flow equations by means of an implicit scheme of finite differences: Applications in the case of alternately free and pressurized flow in a tunnel. La Houille Blanch, No. 1.
- Song, C.S. 1976. "Two-phase flow hydraulic transient model for storm sewer systems." In Second Int. Conf. on Pressure Surges, The City University, London, England.
- \_\_\_\_\_; Leung, K.S.; and Cardle, J.A. 1979. The dynamic mixed-flow model for metropolitan St. Louis sewer district. Proj. Rep. No. 185, St. Anthony Falls Hydraulic Laboratory, University of Minnesota.
- \_\_\_\_\_, and Leung, K.S. 1980. Mathematical modeling for Cross-Irondequoit Tunnel and associated facility. Proj. Rep. No. 195, St. Anthony Falls Hydraulic Laboratory, University of Minnesota.
- Streeter, V.L., and Wylie, E.B. 1967. Hydraulic transients. New York: McGraw-Hill.

## FLOOD ROUTING THROUGH A SERIES OF DETENTION PONDS

Rong-Shun Liu, Chief Engineer  
Hydraulics and Hydrology  
Lichliter/Jameson & Associates, Inc.  
Houston, Texas 77036, USA

Johnny R. Barker, Vice President  
Lichliter/Jameson & Associates, Inc.  
Houston, Texas 77036, USA

## INTRODUCTION

In recent years, storm water detention has become a more popular and acceptable flood preventative measure used by planners in government agencies in the United States. The main purpose of a detention pond is to attenuate the peak flow produced upstream and to release only the maximum discharge which is equal to the existing condition. Liu and Barker (1981) developed a computer program which routes a flood hydrograph through a single storm water detention pond based on the effect on downstream receiving waters in areas with relatively small relief or coastal zones. The routing procedure becomes more complicated when a series of two or more detention ponds is required because of physical or economical limitations.

The computer program for a flood hydrograph has been revised to route the flow of flood waters through a series of two ponds by taking into account the variations of headwater and tailwater discharged at each pond, as well as by balancing the storage routing equation to determine the sizes of the ponds and their outlet structures.

## STORAGE ROUTING THROUGH TWO PONDS IN A SERIES

The Puls method (1928) for reservoir routing can be used for a series of ponds when the tailwater elevation does not produce a pressure flow condition over the outlet structures. The equation can be written as

$$\frac{1}{2}(I_{i,j} + I_{i+1,j}) \Delta t - \frac{1}{2}(O_{i,j} + O_{i+1,j}) \Delta t = S_{i+1,j} - S_{i,j} \quad (1)$$

in which

$I_{i,j}, I_{i+1,j}$  = inflow to pond  $j$  at end of time period  $i$  and  $i+1$

$O_{i,j}, O_{i+1,j}$  = outflow from pond  $j$  at end of time period  $i$  and  $i+1$

$S_{i,j}, S_{i+1,j}$  = storage at pond  $j$  at end of time period  $i$  and  $i+1$

$\Delta t$  = length of each time period in seconds.

Equation (1) can then be rewritten as

$$\frac{1}{2}(I_{i,j} + I_{i+1,j}) \Delta t + S_{i,j} - \frac{1}{2}O_{i,j} \Delta t = S_{i+1,j} + \frac{1}{2}O_{i+1,j} \Delta t \quad (2)$$

Equation (2) can be graphically solved by constructing  $O$  versus  $S \pm \frac{1}{2}O \Delta t$  curves for each pond under low flow conditions. The stage discharge curve loses its continuity when the pressure flow over the outlet structures com-

mences. The discharge will then be a function of the difference in head upstream and downstream of the outlet structures. Equation (1) can also be written as

$$\frac{1}{2}(I_{i,j} + I_{i+1,j}) \Delta t - \frac{1}{2}(O_{i,j} + O_{i+1,j}) \Delta t + S_{i,j} = S_{i+1,j} \quad (3)$$

The discharge  $O_{i+1,j}$  and storage  $S_{i+1,j}$  are the two unknowns correlated to the head difference of the upstream and downstream sides of the pond. By estimating an initial value of head difference,  $O_{i+1,j}$  can be derived from the function of the difference in head and  $S_{i+1,j}$  can be computed from equation (3). The iteration procedure continues until the estimated head difference approximates the calculated head difference.

One of the main differences between routing through a single pond and a series of two ponds is that all the calculations for the first, or upstream pond are always an estimate until the completion of the second, or downstream pond shows an agreeable headwater elevation compared to the estimated tailwater elevation of the first pond. Figure 1 is a flow diagram for the computer program simulations.

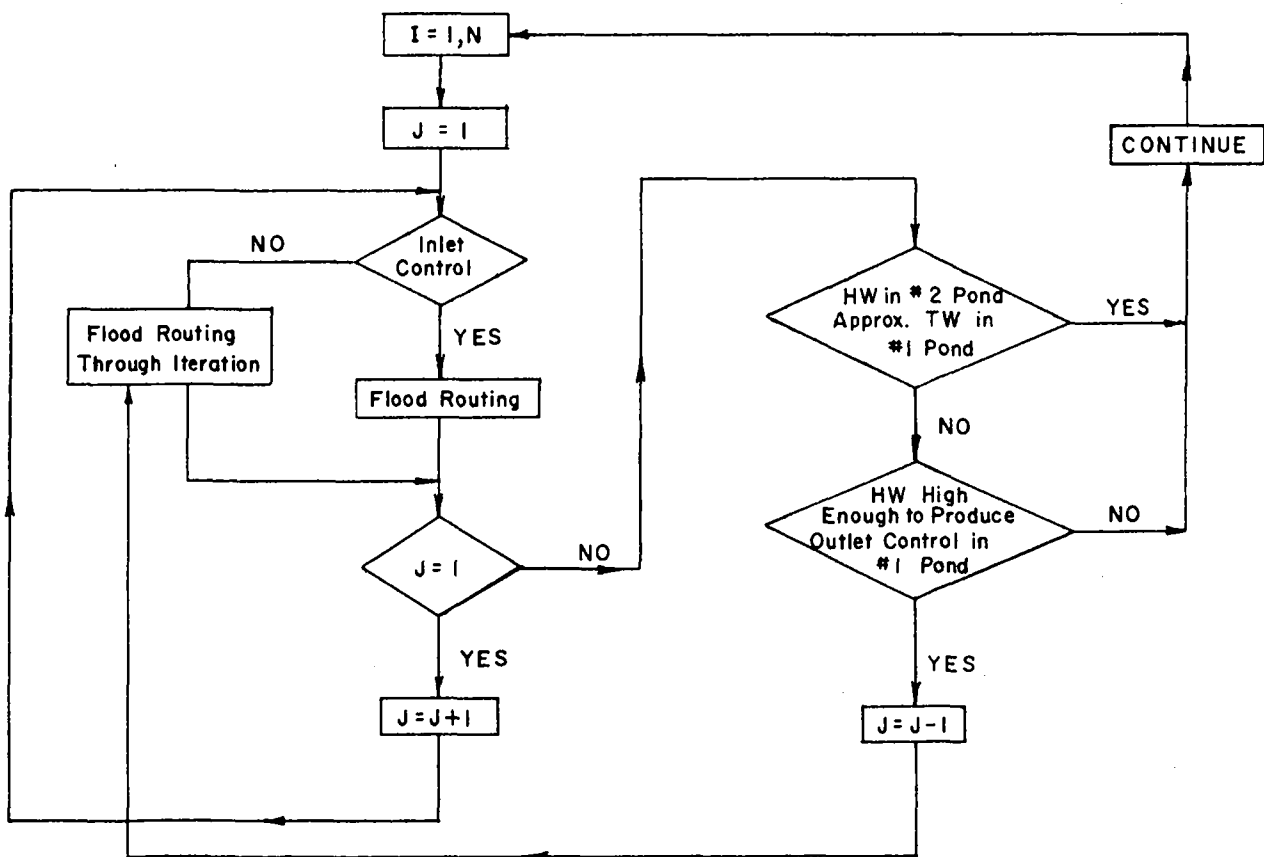

Figure 1. Diagram for computer program simulation

## INPUT AND OUTPUT OF COMPUTER PROGRAM

PROGRAM INPUT. The input parameters for the computer program will include the following:

1. Inflow hydrographs for each pond at different frequency flood (QIN)
2. Stage-storage curve for each pond (E vs. STO)
3. Stage-discharge curve for each pond (E vs. DS for inlet control, H vs. ODS for outlet control)
4. Tailwater elevation of downstream pond at end of each time period before discharge occurs (BKW) - (Derived from HEC-2 computer model [1976])
5. Tailwater elevation of downstream pond at end of each time period, assuming maximum allowable discharge can be made from detention pond (BKWT)
6. Tailwater elevation at each pond at which pressure flow occurs (TP)
7. Time in seconds for each time period (DT)
8. Maximum allowable discharge through downstream storage pond (QMAX)
9. Flow-line elevation on both sides of outlet structures for each pond (FU, FD)
10. Total number of time periods in flood hydrograph (N)
11. Total number of points in stage-discharge and stage-storage curve for each pond (M)
12. Total number of points in head difference vs. discharge curve for each pond (K).

PROGRAM OUTPUT. The output parameters for the computer program will include the following:

1. Inflow to first pond at end of each time period
2. Storage in first pond at end of each time period
3. Water surface elevation in first pond at end of each time period
4. Discharge from first pond at end of each time period
5. Tailwater elevation of first pond at end of each time period
6. Inflow to second pond (excluding release from first pond) at end of each time period
7. Storage in second pond at end of each time period
8. Water surface elevation in second pond at end of each time period
9. Discharge from second pond at end of each time period
10. Tailwater elevation of second pond at end of each time period.

## APPLICATION OF STORAGE ROUTING COMPUTER PROGRAM

Two storage detention ponds in a series are needed for a land developer to attenuate the 100-yr peak flow produced by urbanization. The 100-yr flood hydrograph with existing and developed conditions were calculated by using the U.S. Army Corps of Engineers HEC-1 computer model (1973). The maximum allowable discharge through the pond is  $8.77 \text{ m}^3/\text{s}$  (310 cfs) which is equal to the 100-yr peak flow for an undeveloped condition. Figure 2 is a sketch of detention ponds and outlet structures resulting from the routing procedure through the computer program. Table 1 through 4 shows the standard program input and Table 5 shows the output through the storage routing.

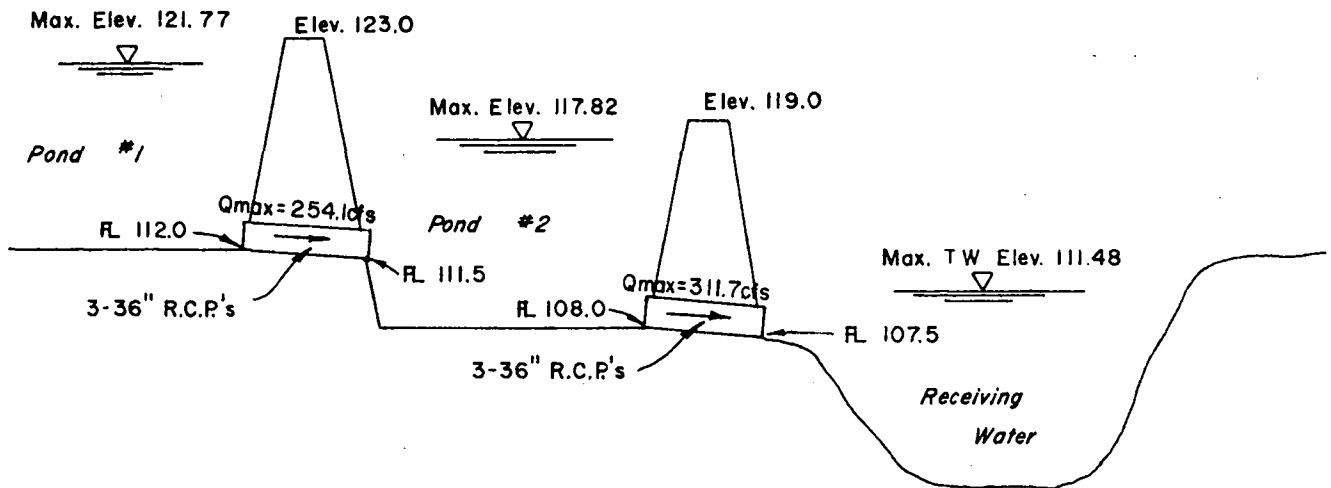

Figure 2. Sketch of detention ponds and outlet structures

#### CONCLUSION

The computer program developed for flood routing through storage ponds serves practical uses for planning as well as the design phase. In an area of small relief or in coastal zones, smaller detention ponds in a series will sometimes serve a better purpose from both the economic or physical aspects. Ignorance or carelessness of the downstream situation will sometimes cause a great degree of flooding problems in the surrounding area. The computer program presented here will help determine the size of ponds as well as outlet structures.

#### REFERENCES

- Hydrologic Engineering Center. 1973. HEC-1 Flood Hydrograph Package. U.S. Army, Corps of Engineers, Davis, California, January 1973.
- Hydrologic Engineering Center. 1976. HEC-2 Water Surface Profiles. U.S. Army, Corps of Engineers, Davis, California, November 1976.
- Liu, R.S., and Barker, J.R. 1981. "Flood routing through storage detention pond." Paper presented to 1981 International Symposium for Urban Hydrology, Hydraulics and Sediment Control, University of Kentucky, Lexington, Kentucky, 28-30 July 1981.
- Puls, L.G. 1928. "Flood regulation of the Tennessee River." 70th Congr., 1st Sess., H.D. 185, Pt. 2, Appendix B, 1928.

TABLE 1. VARIABLES DETERMINED FROM PRELIMINARY DESIGN

QMAX (cfs)	DT (s)	N	M	K	TP		FU		FD	
					Pond 1	Pond 2	Pond 1	Pond 2	Pond 1	Pond 2
310	1800	50	11	9	114.5	110.5	112.0	108.0	111.5	107.5

NOTE: 1 cfs = 0.0283 m<sup>3</sup>/s.  
1 ft = 30.48 cm.

TABLE 2. ITEMS DERIVED FROM HYDROGRAPH AND BACKWATER INPUT COMPUTATIONS

TIME PERIOD (½ hr)	INFLOW		T/W ELEVATION		TIME PERIOD (½ hr)	INFLOW		T/W ELEVATION	
	Pond 1 (QIN in cfs)	Pond 2 (QIN in cfs)	(BKW in ft)	(BKWT in ft)		Pond 1 (QIN in cfs)	Pond 2 (QIN in cfs)	(BKW in ft)	(BKWT in ft)
1	0	0	105.0	105.3	26	362	84	109.5	110.4
2	1	1	105.2	105.6	27	410	79	110.0	110.9
3	3	1	105.4	105.9	28	372	75	110.3	111.2
4	7	2	105.6	106.1	29	322	70	110.4	111.4
5	10	3	105.7	106.2	30	276	66	110.5	111.5
6	14	4	105.9	106.5	31	233	62	110.4	111.4
7	19	6	106.0	106.6	32	194	58	110.3	111.3
8	26	7	106.3	106.9	33	162	55	110.2	111.2
9	31	8	106.6	107.1	34	136	51	110.1	111.1
10	35	9	106.9	107.5	35	116	48	110.0	110.9
11	39	11	107.0	107.6	36	99	46	110.0	110.9
12	42	12	107.3	107.9	37	86	43	109.9	110.8
13	44	14	107.4	108.0	38	75	40	109.8	110.7
14	47	15	107.6	108.2	39	67	37	109.7	110.6
15	51	17	107.7	108.4	40	60	35	109.6	110.4
16	55	20	107.9	108.6	41	54	32	109.6	110.4
17	59	24	108.0	108.7	42	49	30	109.5	110.3
18	63	31	108.1	108.8	43	41	28	109.4	110.2
19	68	42	108.2	109.0	44	33	26	109.3	110.1
20	73	55	108.2	109.0	45	27	24	109.2	110.0
21	79	69	108.3	109.1	46	27	22	109.2	109.0
22	91	81	108.4	109.2	47	17	21	109.1	109.8
23	114	88	108.6	109.4	48	14	19	109.0	109.7
24	149	90	108.8	109.6	49	11	18	108.9	109.5
25	236	88	109.1	110.0	50	8	17	108.8	109.4



TABLE 3. STAGE-STORAGE AND DISCHARGE RATING (INLET CONTROL)  
COMPUTER PROGRAM INPUT

STAGE (ft)	STORAGE		DISCHARGE		STAGE (ft)	STORAGE		DISCHARGE	
	Pond 1 -(acre-ft)-	Pond 2	Pond 1 ---(cfs)---	Pond 2		Pond 1 -(acre-ft)-	Pond 2	Pond 1 ---(cfs)---	Pond 2
0	0	0	0	0	6	10.0	5.2	240	240
1	1.5	0.4	25	25	7	14.0	6.7	260	260
2	2.0	1.0	60	60	8	19.0	8.4	280	280
3	3.5	1.8	114	114	9	24.0	10.2	300	300
4	5.5	2.8	160	160	10	30.0	12.2	320	320
5	7.5	3.9	200	200					

NOTE: 1 acre-ft =  $1.234 \times 10^3 \text{ m}^3$ .

TABLE 4. DISCHARGE RATING (OUTLET CONTROL)  
COMPUTER PROGRAM INPUT

DIFFERENCE IN HEADS (ft)	DISCHARGE		DIFFERENCE IN HEADS (ft)	DISCHARGE	
	Pond 1 ----- (cfs) -----	Pond 2		Pond 1 ----- (cfs) -----	Pond 2
0	0	0	5	285	285
1	126	126	6	300	300
2	180	180	7	330	330
3	216	216	8	360	360
4	250	250			

TABLE 5. FLOOD ROUTING THROUGH STORAGE PONDS IN A SERIES  
COMPUTER PROGRAM OUTPUT

DT	Pond	Inflow (cfs)	Storage (acre-ft)	HW El. (ft)	Discharge (cfs)	TW El. (ft)
1	1	0.0	0.0	112.00	0.0	108.00
	2	0.0	0.0	108.0	0.0	105.00
2	1	1.0	0.06	112.04	1.0	108.04
	2	1.0	0.02	108.04	1.0	105.20
3	1	3.0	0.09	112.06	1.5	108.10
	2	1.0	0.04	108.10	2.4	105.40
4	1	7.0	0.20	112.13	3.3	108.16
	2	2.0	0.07	108.16	4.1	105.61
5	1	10.0	0.36	112.24	6.0	108.30
	2	3.0	0.12	108.30	7.5	105.71
6	1	14.0	0.54	112.36	9.1	108.46
	2	4.0	0.18	108.46	11.5	105.92

TABLE 5.—Continued

DT	Pond	Inflow (cfs)	Storage (acre-ft)	HW El. (ft)	Discharge (cfs)	TW El. (ft)
7	1	19.0	0.77	112.51	12.9	108.66
	2	6.0	0.26	108.66	16.5	106.03
8	1	26.0	1.07	112.71	17.8	108.90
	2	7.0	0.36	108.90	22.5	106.34
9	1	31.0	1.40	112.93	23.3	109.10
	2	8.0	0.46	109.10	28.6	106.65
10	1	35.0	1.61	113.22	32.5	109.35
	2	9.0	0.61	109.35	37.1	106.97
11	1	39.0	1.68	113.37	37.8	109.60
	2	11.0	0.76	109.60	45.9	107.09
12	1	42.0	1.73	113.46	41.0	109.75
	2	12.0	0.85	109.75	51.4	107.40
13	1	44.0	1.76	113.52	43.4	109.87
	2	14.0	0.92	109.87	55.5	107.51
14	1	47.0	1.80	113.60	45.9	109.98
	2	15.0	0.99	109.98	59.5	107.72
15	1	51.0	1.85	113.70	49.6	110.08
	2	17.0	1.07	110.08	64.4	107.85
16	1	55.0	1.91	113.82	53.6	110.20
	2	20.0	1.16	110.20	71.0	108.06
17	1	59.0	1.97	113.93	57.6	110.35
	2	24.0	1.28	110.35	78.7	108.18
18	1	63.0	2.03	114.02	61.2	100.52
	2	31.0	1.42	110.52	88.2	108.30
19	1	68.0	2.14	114.09	64.9	110.77
	2	42.0	1.61	110.77	101.4	108.46
20	1	73.0	2.27	114.18	69.7	111.08
	2	55.0	1.88	111.08	117.5	108.50
21	1	79.0	2.42	114.28	75.1	111.43
	2	69.0	2.23	111.43	133.9	108.65
22	1	91.0	2.65	114.44	83.5	111.86
	2	81.0	2.66	111.86	153.8	108.80
23	1	114.00	3.10	114.74	99.7	112.34
	2	88.0	3.18	112.34	173.7	109.05
24	1	149.0	3.92	115.21	123.7	112.92
	2	90.0	3.81	112.92	196.9	109.31
25	1	236.0	5.86	116.18	167.3	113.66
	2	88.0	4.76	113.66	226.4	109.76
26	1	362.0	10.18	118.04	221.9	114.85
	2	84.0	6.39	114.79	255.8	110.24

TABLE 5.—Continued

DT	Pond	Inflow (cfs)	Storage (acre-ft)	HW El. (ft)	Discharge (cfs)	TW El. (ft)
27	1	410.0	16.65	119.53	237.0	115.88
	2	79.0	8.06	115.80	285.3	110.83
28	1	372.0	22.69	120.74	252.5	116.64
	2	75.0	9.44	116.58	291.4	111.15
29	1	322.0	26.58	121.43	253.5	117.31
	2	70.0	10.73	117.26	297.2	111.36
30	1	276.0	28.44	121.74	254.1	117.64
	2	66.0	11.58	117.69	305.1	111.48
31	1	233.0	28.62	121.77	246.6	117.86
	2	62.0	11.85	117.82	310.7	111.40
32	1	194.0	27.25	121.54	246.4	117.67
	2	58.0	11.65	117.73	311.7	111.31
33	1	162.0	24.55	121.09	240.5	117.41
	2	55.0	11.22	117.51	309.0	111.20
34	1	136.0	21.12	120.42	223.5	117.17
	2	51.0	10.41	117.10	300.5	111.07
35	1	116.0	17.12	119.62	222.1	116.47
	2	48.0	9.34	116.52	295.9	110.86
36	1	99.0	12.60	118.65	211.5	115.81
	2	46.0	8.21	115.89	286.5	110.83
37	1	86.0	8.25	117.30	183.9	115.16
	2	43.0	6.81	115.06	265.5	110.67
38	1	75.0	5.45	115.98	112.9	113.53
	2	40.0	4.59	113.53	221.3	110.44
39	1	67.0	3.63	115.07	117.1	112.13
	2	37.0	2.95	112.13	165.3	110.18
40	1	60.0	2.34	114.23	72.4	111.40
	2	35.0	2.20	111.40	132.3	109.94
41	1	54.0	1.99	113.97	59.0	110.69
	2	32.0	1.55	110.69	97.3	109.85
42	1	49.0	1.86	113.72	50.1	110.44
	2	30.0	1.35	110.44	83.6	109.72
43	1	41.0	1.77	113.54	44.1	110.28
	2	28.0	1.22	110.28	74.9	109.59
44	1	33.0	1.65	113.31	35.7	110.10
	2	26.0	1.08	110.10	65.6	109.47
45	1	27.0	1.56	113.11	29.0	109.89
	2	24.0	0.94	109.89	56.2	109.35
46	1	27.0	1.52	113.05	26.6	109.72
	2	22.0	0.83	109.72	50.3	109.31

TABLE 5.—*Continued*

DT	Pond	Inflow (cfs)	Storage (acre-ft)	HW El. (ft)	Discharge (cfs)	TW El. (ft)
47	1	17.0	1.40	112.93	23.3	109.60
	2	21.0	0.76	109.60	46.1	109.20
48	1	14.0	1.16	112.77	19.3	109.45
	2	19.0	0.67	109.45	40.9	109.09
49	1	11.0	0.95	112.63	15.8	109.30
	2	18.0	0.58	109.30	35.6	108.97
50	1	8.0	0.76	112.50	12.6	109.18
	2	17.0	0.51	109.18	31.3	108.86

## RAIN AND WASTE WATER REUSE FOR TOILET FLUSHING: A SIMULATION MODEL

A. Fewkes, Research Graduate  
Trent Polytechnic  
Department of Building and  
Environmental Health  
Nottingham, UNITED KINGDOM

S.A. Ferris, Research Supervisor  
Trent Polytechnic  
Department of Building and  
Environmental Health  
Nottingham, UNITED KINGDOM

## INTRODUCTION

The reuse of rain and domestic waste water for water closet flushing has an effect on the water resources of a country: this conservation may have a particular impact in areas where the carrier for the waste water is salt water or where the potable water carrier is in short supply. In the United Kingdom, 30% of the potable water supplied to the domestic sector is used for the transportation of waste water; however, the advantages of a reuse system are unlikely to be relevant here because of the abundance of cheap potable water.

This paper considers two water closet (WC) supply systems: one is rain water collected from the roof and the other combines rain and domestic waste water. The stochastic nature of the rain and waste water time series have been simulated using the Monte Carlo method. Subsequently, the operation of each system is modelled to determine the percentage of WC water conserved per annum for a range of tank capacities, roof area and family sizes.

## STORAGE SYSTEMS

In each system, a single tank is placed at or below ground level to receive one or more of the waste discharges, as appropriate. The location of the storage tank above ground level obviates excavation and alterations to the below ground drainage system; however, if space is restricted, the collection vessel can be either below ground level or in the roof space. The waste water inputs to the system are from the bath and the automatic washer; flows from the kitchen sink and waste disposal unit are excluded because these contain food debris and greases which, it is anticipated, would aggravate the storage and treatment processes.

The rain and waste water must be pumped to the flushing cistern at a minimum rate of 7 l/min to comply with the United Kingdom requirements (British Standard Institute 1965). The system is simple and consists of a tank overflow and a pump controlled by a float switch in the cistern. To prevent system failure, water is supplied from the mains via a ball-valve when the level of stored water falls below a critical value.

## DESIGN PROBLEM

The system designer must ensure that water is always available for the flushing of toilets. Storage for rain and waste water is necessary because the rates of flow and occurrences of supply and demand are different and expressed as

$$R(t) + M(t) + B(t) = W(t) \quad (1)$$

where  $R(t)$ ,  $M(t)$  and  $B(t)$  are the supplies from the rainfall, washing machine and bath, and  $W(t)$  is the toilet flushing demand.

The design problem is the evaluation of the optimal size of a storage vessel, that is, the smallest tank capacity which will satisfy the toilet flushing demand. As a result, the derivation of the rain and waste water supply patterns is therefore essential; these supply patterns are nondeterministic and follow a time dependent, nonstationary stochastic process (Gibson 1978). A collection of sampled values made sequentially in time from such a process is known as a time series, which may be continuous or discrete.

Two methods of obtaining the time series which describe adequately the randomness of rainfall and domestic water usage patterns were considered: either the collection of actual rainfall and waste flow patterns or their simulation using a numerical technique. The first method was rejected because if the information had been available, the manipulation of, say, three or four years daily rainfall and domestic usage patterns into a form suitable to model the storage system is inefficient and time consuming. Moreover, the resultant model is inflexible and limited to the period covered by the flow patterns; however, the time series can be generated for unlimited periods using a simulation model.

#### MONTE CARLO SIMULATION

**TIME FLOW MECHANISM.** The model is based on a discrete time interval, the size of which is not so large that the fine structure of events are not resolved or so small that nothing changes. A time interval of one day has been found to be adequate (Fewkes 1980).

**CUMULATIVE PROBABILITY DISTRIBUTIONS.** The volume of rain water collected daily by a given roof area is simulated for each month of the year using cumulative probability distributions of rainfall in the Nottingham area (Meteorology Office 1963). Similarly, the daily waste water flows from the bath, washing machine and WC are generated using cumulative probability distributions of both the number of appliance uses per day and the volume of each usage (Thackray, Crocker and Archibald 1978).

**SIMULATION MODEL.** The Monte Carlo technique provides a method of simulating the rain and waste water time series; the probable daily volume of each flow is defined by using random numbers to index the cumulative probability distributions. Although a specific value is determined by chance, the mean and distribution of an infinite number of values determined by this process will fit the originally defined distribution and have the same mean and variance (Hammersley 1964).

The random numbers are defined by a continuous uniform distribution,

$$f(x) = \begin{cases} \frac{1}{B - A} & A < x < B \\ 0 & \text{otherwise} \end{cases} \quad (2)$$

where the limits of A and B determine the numerical range over which the random numbers are generated.

The method of simulating daily rainfall levels is described as an example, but the WC, bath and washing machine series are generated in a similar manner. The distribution of the random variable  $R_J$  describes the daily rainfall level during month J and the probability function is  $f(r_j)$  where the distribution function or cumulative probability function is

$$F(r_j) = \text{Prob} \{R_J \leq r_{jz}\} \quad (3)$$

Alternatively,

$$F(r_j) = \int_0^{r_{jz}} f(r_j) \cdot dr_j \quad (4)$$

where  $f(r_j) \geq 0$ , the  $\int_0^{r_{j\max}} f(r_j) \cdot dr_j = 1$  and  $r_{j\max}$  represents the maximum level of daily rainfall during month J.

The rainfall level is simulated by generating a random number from the uniform distribution  $f(x)$ ; the limits of equation (2) become  $B = 1$  and  $A = 0$ , thus defining  $x$  within the range  $0 \leq x \leq 1$ . The model iteratively compares the value of  $x$  with  $F(r_j)$  for progressively increasing values of  $R_J$ , that is,

$$r_{j_1}, r_{j_2}, \dots, r_{j_x}, \dots, r_{j\max} \quad (5)$$

where  $r_{j_2} = r_{j_1} + r_j$  or  $r_{j_i} = r_{j_{i-1}} + r_j$ .

The increment  $r_j$  is the discrete increase in the value of  $r_j$ . In this case,  $r_j = 2.5$  mm rainfall, but finer resolution would be achieved with a smaller increment.

The comparison between  $F(r_j)$  and  $x$  continues until

$$F(r_j) \geq x = \text{Prob} \{R_J \leq r_{j_1}\} \quad (6)$$

provided that at the previous increment,

$$F(r_{j_{i-1}}) < x. \quad (7)$$

The simulated level of rainfall that day is equal to  $r_{j_i}$  which is equivalent to the solution of

$$\int_0^{r_{j_i}} f(r_j) \cdot dr_j = x. \quad (8)$$

The nature of the function is not known but a general method of solution is provided by the iterative technique.

The simulation of the waste water flows uses the same technique but in addition to the volume the number of uses is also simulated.

## SYSTEM SIMULATION MODEL

The rain and waste water series are used as input to the system models which simulate the physical operation of the WC supply; each system model evaluates the volume of rain and waste conserved expressed as a percentage of the total flushing demand. The model of the system includes several assumptions:

1. Rainfall is vertical and falls on the entire roof area
2. evaporation losses are negligible
3. and effects due to droplet size and variations in wind and pressure around the roof are also ignored.

These aspects may be included in the model as they become pertinent to a particular design.

The model determines the stored volume ( $V$ ) at regular time intervals ( $t$ ), each of one-day duration, from the beginning of the period ( $T_1$ ) to the end ( $T_2$ ). The volume of water conserved is progressively evaluated and at the end of the period ( $T_2$ ) expressed as a percentage ( $P$ ) of the total flushing demand.

MAGNITUDE OF THE SIMULATED TIME PERIOD,  $T_1 - T_2$ . The simulation produces  $n$  "observed" values of  $P$  for each tank capacity modelled, however, a value observed during one time interval is influenced by the value at an earlier time (FEWKES 1981). That is, the results are not mutually independent and traditional statistical methods are invalid.

Consider a sequence of time intervals where the storage vessel is empty initially at time,  $T_1$ . At the end of the period,  $T_2$ , a sequence of supplies and demands have occurred but if a residual volume of water,  $V_r$ , remains in storage at  $T_2$  this will influence the amount of waste conserved during the subsequent interval,  $T_2 - T_3$ . If  $V_r > 0$  for a large proportion of the intervals the value of  $P$  will not be independent; therefore, a large period of one year is used in the computer model so that  $V_r$  is small compared with the volume of water conserved, so that the results are in effect mutually independent.

NUMBER,  $n$ , OF SIMULATION RUNS. The frequency distributions of  $P$  for different tank sizes have a transient nature, that is, the degree of skewness increases with storage capacity; consequently, statistical inferences about the random variable are difficult. However if the central limit theorem is applied to the random variable  $\mu\bar{x}_p$ , that is, the sample mean of  $P$ , the underlying distribution of  $P$  need not be known. Moreover, the distribution of  $\mu\bar{x}_p$  is normal for large values of  $n$  ( $n \geq 30$ ). The number of simulation runs necessary to achieve values of  $\mu\bar{x}_p$  with a maximum acceptable error is related to the standard deviation of  $\mu\bar{x}_p$ . However, with  $n = 50$ , it has been found that the error of  $\mu\bar{x}_p$  will not exceed  $\pm 1\%$  at a 99% level of confidence.

## RESULTS

The performance is evaluated for tanks ranging from 100 to 1200 l; the evaluation is repeated for family sizes of two, four and six people. The simulation uses an average rainfall of 560 to 600 mm which relates to the Nottingham area. The mean volume of rain and waste water collected per annum expressed as a percentage of the total flushing demand is determined for each storage vessel using 50 years of simulated data.



RAINFALL AND WASTE WATER TIME SERIES. The time series (Fig. 1[a]) which has been generated show that 40% of the annual precipitation results from daily amounts of 1.5 mm or 2.5 mm; this is because the cumulative probability distributions are based on discrete intervals. A more realistic time series could be simulated if continuous distributions or a smaller interval were used below the 5 mm class.

The rain and waste water time series for a family size of six with a 50 m<sup>2</sup> roof (Fig. 1[b]) indicates the usefulness and advantages of including waste water into the input source. When rainfall is the only input, water flows into the storage for approximately 55% of the year, whereas including waste water increases this to 85% days of the year. In fact, the domestic waste produces an average flow for 66% of the yearly days. These figures of 66% and 55% combine to give 85% because some of the flows will be coincident.

RAIN WATER COLLECTION SYSTEM. A house with a roof area of either 100 m<sup>2</sup> or 75 m<sup>2</sup> occupied by two people conserves at least 90% of the WC flushing requirement with respective tank capacities of 350 and 500 l (Fig. 2[a]). With a catchment of 75 m<sup>2</sup>, the storage reservoir must be enlarged to 1100 l to attain a 97% conservation level, and this increases to 99½% with an additional 900 l of storage capacity. Alternatively, a 50-m<sup>2</sup> roof is capable of 90% conservation with a storage tank of 1200 l; however, if the collection volume is reduced by almost half to 700 l, the conservation is reduced by only 5% to 85% of the WC flushing demand (Fig. 2[a]).

The conservation curves for a 2-person family (Fig. 2[a]) are grouped closer together than for households of four and six people (Fig 2[b], [c]) because the demand for flushing water increases with household size. A catchment area of 100 m<sup>2</sup> and family size of four is capable of 90% conservation only with a tank size in excess of 1100 l (Fig. 2[b]). In fact, a family of six cannot achieve 90% conservation even with a 100-m<sup>2</sup> roof: the maximum conservation level is 86% with a 1700-l tank (Fig. 2[c]).

Generally, an increase in tank capacity results in a disproportionate rate of growth of water conservation. However, a point is reached on each set of curves where increases in storage capacity result in only a marginal increase in water conservation.

RAIN AND WASTE WATER COLLECTION SYSTEM. The curves for the smallest household are all grouped closely together (Fig. 3[a]); a tank within the 150- to 250-l range will conserve 90% of the flushing water. The lower limit applies to the 100-m<sup>2</sup> roof and the upper to the 25-m<sup>2</sup> catchment. The corresponding range of tank sizes for the four-person household is 200 to 300 l (Fig. 3[b]) and for 6 people is 250 to 400 l (Fig. 3[c]). A household of two people attains 99.5% conservation with a 600-l storage; the limits for four- and six-person households are respectively 800 and 900 l.

## DISCUSSION

Two WC supply systems have been designed and evaluated using a simulation model. Time series based on a minimum interval of a day are generated using the Monte Carlo technique; these are used as input to the system models to obtain the optimum storage capacities for different combinations of roof area

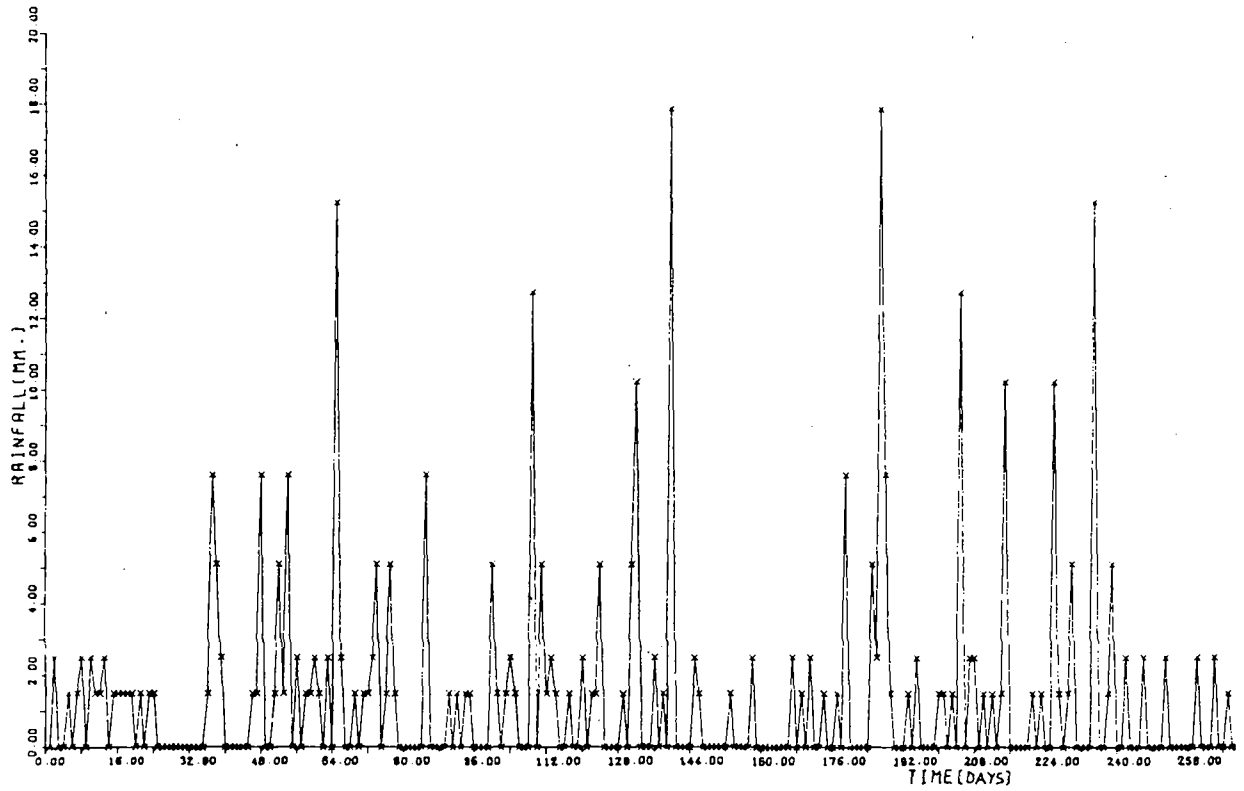

(a) Rainfall

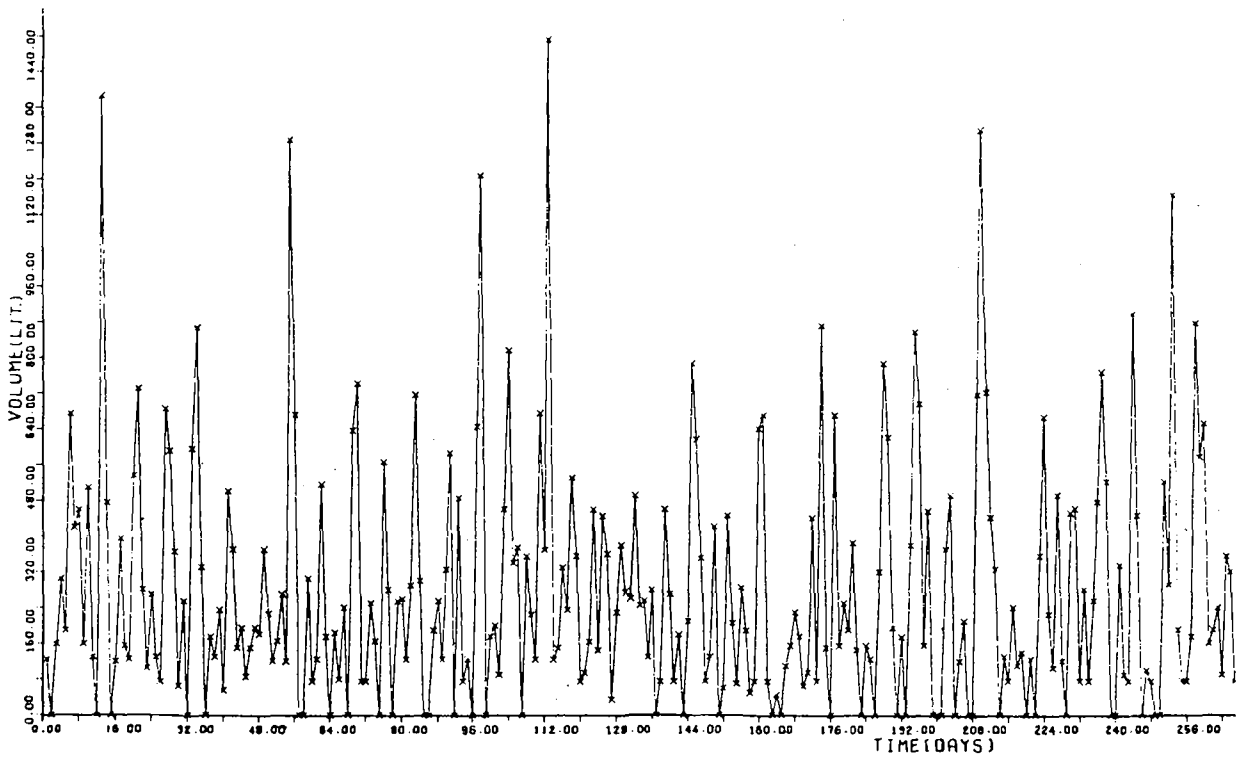

(b) Rain and waste water

Figure 1. Monte Carlo simulated time series

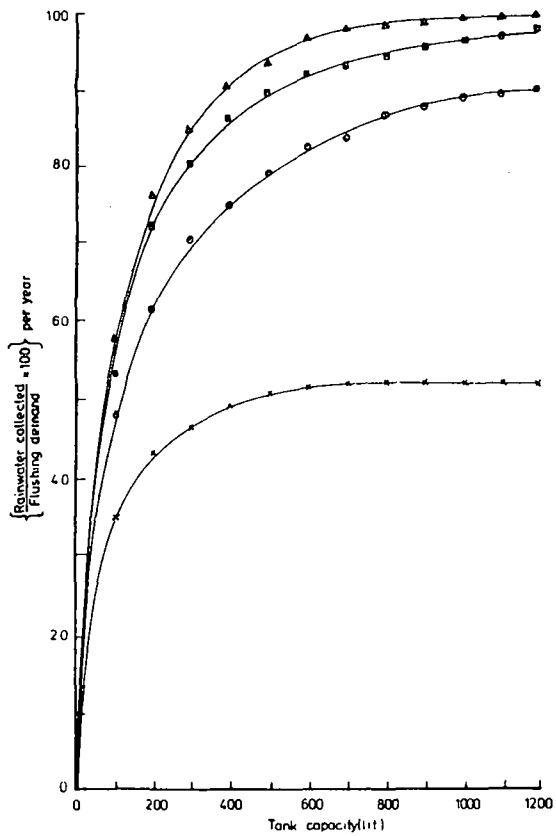

(a) Household size two.

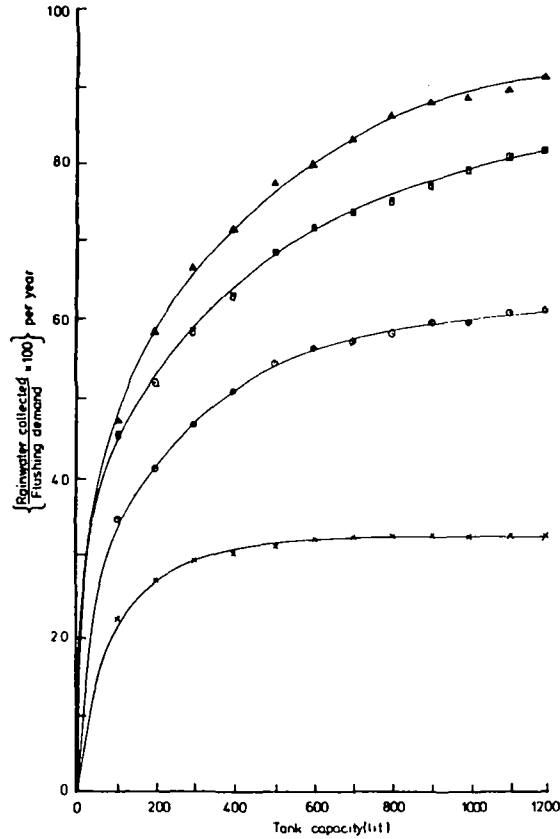

(b) Household size four.

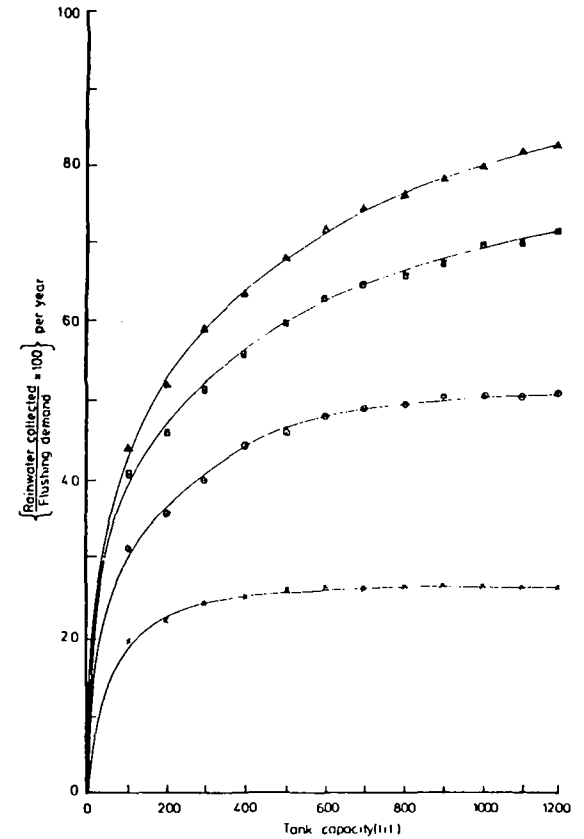

(c) Household size six.

—x— Roof area 25 m<sup>2</sup>      —□— Roof area 75 m<sup>2</sup>  
 —o— Roof area 50 m<sup>2</sup>      —△— Roof area 100 m<sup>2</sup>

Figure 2. The effects of family size and roof area on the capacity and efficiency of the rainwater store

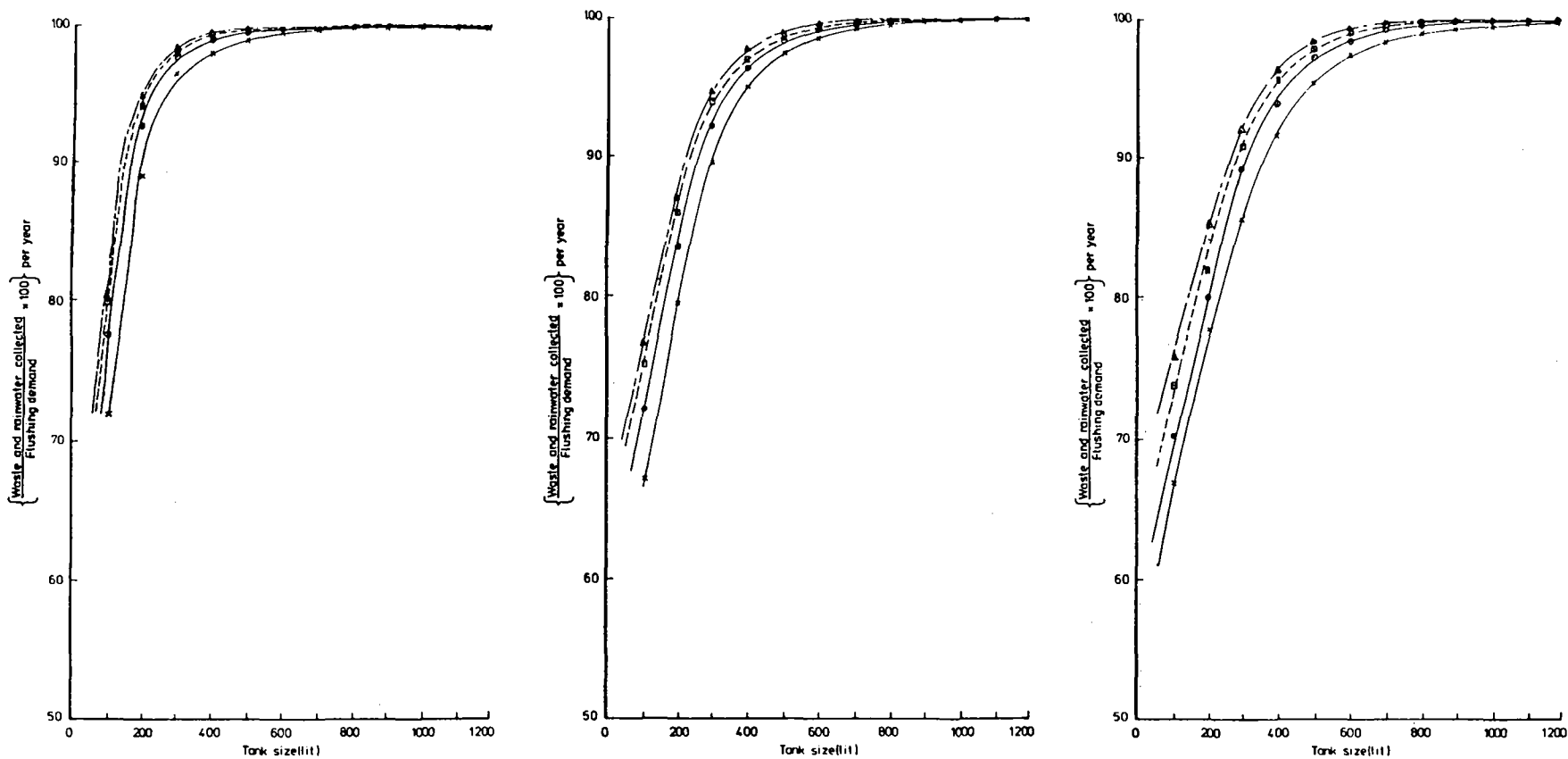

(a) Household size two.

(b) Household size four.

(c) Household size six.

- x— Roof area 25m<sup>2</sup>
- Roof area 50m<sup>2</sup>
- Roof area 75m<sup>2</sup>
- △— Roof area 100m<sup>2</sup>

Figure 3. The effects of family size and roof area on the capacity and efficiency of the waste and rainwater store

and family size.

To conserve 90% of flushing water with a rain water collection system, a household of two people requires a minimum catchment of 75 m<sup>2</sup> and of four people 100 m<sup>2</sup>. However, the results for the largest household should form the design standard because the level of occupancy of a household fluctuates over its lifespan. A house with a 100 m<sup>2</sup> roof occupied by six people is capable of conserving 85% of the flushing water with a 150-ℓ tank which would weigh 1.5 tons when full. A tank fabricated from GRP would be suitable although structural alterations would be necessary if located in the roof space. Perhaps the best location would be at ground level although it would occupy a 1.5-m<sup>3</sup> space.

An alternative for new houses is a flat-roof construction which is flooded to retain rain water. The collected rain water is protected against dirt and freezing by expanded polystyrene insulation, which will also exclude light and therefore prevent plant growth. Leaks from this type of roof are less likely than with a conventional flat roof because the rain water protects and preserves the waterproof membrane (Stephens 1976).

The combined rain and waste water system with a 25-m<sup>2</sup> roof and a tank capacity of 375 or 275 ℓ with a 100-m<sup>2</sup> catchment is capable of 90% conservation; these figures relate to a family size of six. Tanks made from polypropylene are available for this capacity and can be easily accommodated in the roof space. However, the roof drainage would have to be altered and an additional tank provided for the waste water to be collected at ground level before being pumped into the roof space. This input will also increase the pollution load of the rain water and additional treatment may be necessary.

The simulation model enables the stochastic and probabilistic elements of the system to be investigated which are difficult to model analytically. For example, the theory of queues have been applied to the problem of sizing water storage systems in which the volume of water storage is analogous to the queue length. This analogy was first recognized by Moran (1959) in his work on reservoir sizing and subsequently applied by Gibson (1978) to sizing water storage systems in buildings. However, the mathematical analysis is complex and Gibson's analytical solutions are only applicable to very simplified types of demand pattern. This simulation model, however, is both more versatile and more generally applicable.

#### REFERENCES

- British Standard Institute. 1965. British Standard Code of Practice, CP 310. Water Supply, Br. Stand. Inst., U.K.
- Fewkes, A. 1980. The recycling of domestic waste water. A simulation of the usage patterns and the sizing of the storage facility. Tech. Rep. No. 104, Department of Building and Environmental Health, Trent Polytechnic, Nottingham, England.
- Fewkes, A. 1981. "The design of rain and waste water storage systems for domestic dwellings." M. Phil. thesis, Trent Polytechnic, Nottingham, England.

- Gibson, E. 1978. "The design of water storage systems for buildings." Ph.D. dissertation, University of Glasgow, Scotland.
- Hammersley, J.M., and Handscombe, D.C. 1964. Monte Carlo methods. London: Methuen.
- Meteorological Office. 1963. Rainfall over the area of the Trent River Board 1916-50. Hydrological Memo. No. 10, Bracknall, Berks, England.
- Moran, P.A.P. 1959. The theory of storage. London: Methuen.
- Stephens, D.M. 1976. Water storage roofs. The Architect, pp. 77-81, December.
- Thackray, J.E.; Crocker, V.; Archibald, G. 1978. The Malvern and Mansfield studies of domestic water usage. In Proc. Inst. Civ. Engr. 64(1)37-61.

## RAIN WATER CISTERN SYSTEMS IN INDONESIA

Srimoerni Doelhomid, Faculty  
Department of Civil Engineering  
Universtiy of Indonesia  
Jakarta, INDONESIA

### INTRODUCTION

In Indonesia, villagers obtain their domestic water from springs, shallow wells, rivers or lakes. The fast coastal areas have brackish surface water, groundwater and intermittent rivers. In such areas, rain water is collected from roofs for domestic purposes.

From about three to four years ago, the Indonesian government has constructed, with some financial aid from UNICEF, nearly a thousand rain water cistern (RWC) systems in Gunung Kidul, Madura, Lombok and Nusa Tenggara. A program has been established to train groups of villagers to build bamboo-cement cisterns and to construct roof gutters and other component structures. Unfortunately, the storage capacity of the cisterns is not large enough to provide enough water for the very long, dry season demands. H.R. Doelhomid, a University of Indonesia student, conducted a study in which she presented nomograms for the volume of cisterns based on the roof area and family size for the Gunung Kidul area.

In a large-scale, Dutch-aided program now underway in the north coast of West Java, high quality and low quality cisterns of bricks, ferroconcrete, concrete without reinforcement, bamboo cement and ijuk (palm fibre) cement are being constructed.

### OLD RWC SYSTEMS IN KALIMANTAN

Kalimantan is a very fast tidal swamp area on a coastal plain situated along the equator with about evenly distributed rainfall during the entire year. From several centuries ago, rain water has been collected from roofs for domestic purposes because the surface water and groundwater are brackish. Wealthy people build big cisterns, while the poor build smaller ones only for drinking and cooking and are satisfied with slightly brackish water for washing and bathing. The cisterns are mostly made of brick and built under the floor.

### GUNUNG KIDUL PILOT PROJECT

Gunung Kidul, which means southern mountains, is a hilly limestone area with karstic phenomena. Surface runoff disappears in sinkholes that join underground rivers of the many small lakes that appear in the rainy season in isolated valleys between the hills, most dry up soon after a shower; some stay for days or weeks and a few last for months—depending on the permeability of the subsoil.

Sinkholes that are connected to underground rivers serve as a source of drinking water. Where sinkholes are distant from villages and communities, drinking and cooking water is obtained from small lakes which are also used for washing and bathing by people and animals. Thus, a program to upgrade the water quality and use of lakes is underway, including the need to form an impermeable lining on the lake bottom. There are no dug or tube wells for domestic purposes because the groundwater potential is very low.

The Gunung Kidul area is  $\pm 570 \text{ km}^2$  with a population of approximately 252,000, consisting of 44,000 families. People live in small communities spread between the hills, and most are poor. For such an area, the best solution is the collection of rain water from roofs using an RWC system.

About four years ago, the government of Indonesia set up an RWC pilot project with UNICEF aid in the Gunung Kidul area. Because the program has been set up as a self-help system, inexpensive cisterns of bamboo cement are being constructed. The cisterns are small and the source of only drinking and cooking water. Water for bathing and washing are from the upgraded lakes.

A private consulting firm has developed bamboo-cement cisterns (Fig. 1) suitable for self-help programs for poor families. The study is based on the following principles:

1. The design should be such that most of the materials are locally available and the villager can construct his own RWC system
2. The design should be according to the villager's technical capability and way of life
3. The construction cost should be in accordance with the government budget and the financial means of the villager.

Bamboo-cement cisterns are now widely used in the pilot project area. According to experiments, inexpensive reinforcement is best made of the bamboo *Gigantochloapus* since *Bambusa vulgaris* is not very good and *Dendrocalamus* is too expensive. The capacity of a bamboo-cement cistern is at most  $1\ 050 \text{ m}^3$  because of difficulties in making stronger bamboo reinforcement.

**HYDROLOGIC CALCULATIONS.** Hydrologic calculations are not simple. First, the mean rainfall values should not be used for drinking water supply designs because of the possibility that once in two years the collected water will be insufficient. Thus, rainfall data of a 90% or at least of an 80% dry year should be used, which means that a shortage may occur once in ten years or at least once in five years. Second, the design of the cisterns should be based on more detailed hydrological calculations. And third, for a small cistern capacity, all of the water falling on the roof should be collected because of its importance at the end of or during a dry season.

In her report, H.R. Doelhomid is proposing to prepare nomograms for the cistern volume for each problem area based on weekly rainfall of a 90% dry year and on various roof areas, family sizes and per capita water demands. These tables of calculations will help villagers to determine what cistern storage size will be adequate for their needs. For good management purposes, individual family cistern systems are preferable to common systems.

Nomograms for the Gunung Kidul area, based on detailed water balance calculations, are presented in Figure 2. According to H.R. Doelhomid's study,



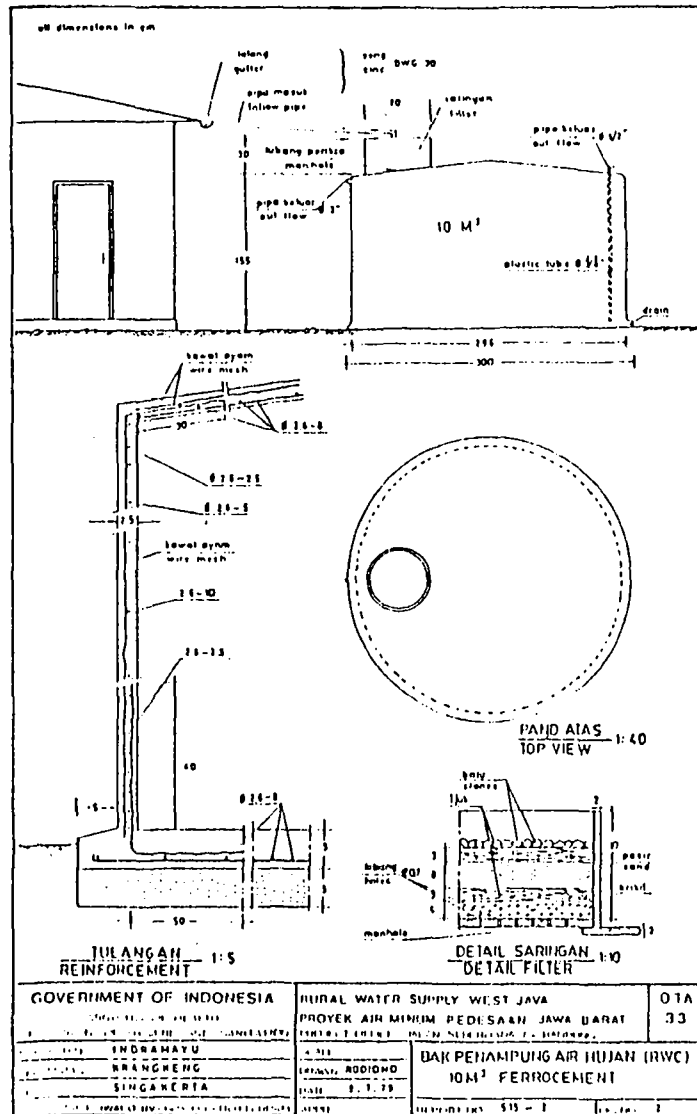

Copied from West Java Rural Water Supply Project, Tuinhof A, IWACO.

Figure 1. Design of 10 m<sup>3</sup> ferrocement rain water cistern system

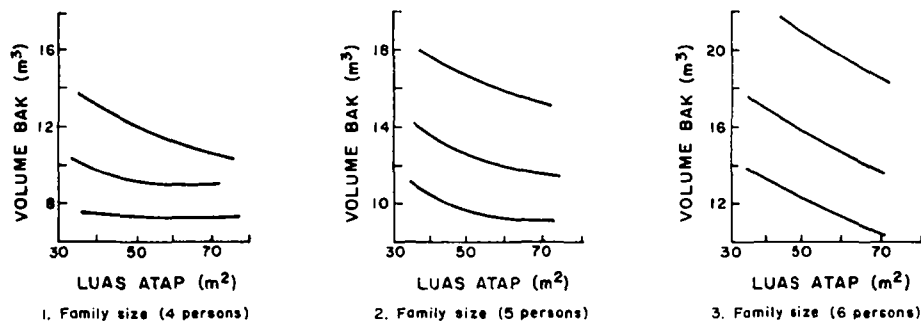

Figure 2. Cistern volume nomograms based on roof area and family size

the existing capacities of the cisterns are only about one third of the calculated volume. It is probable that the cisterns have been under designed; therefore, at the end of every dry season, the families having such a RWC system will suffer from water shortages. In an 80% dry year, the shortage could last for three to four months.

**TRAINING.** The government has set up a training program for a group of villagers in the construction of RWC systems, especially in building ferro and bamboo-cement cisterns. This group of trained people in each village will in turn be able to train others in their community to build these cisterns. Each trained group consists of a skilled workman from the village, two farmers who serve as his assistants and an official of the health service who is the supervisor.

The workers are trained to build the framework (reinforcement), which is new to all of them. They are unaccustomed to plastering, for which they are not allowed to use trowels and must use their hands protected by gloves.

According to an August 1979 report by D. Desa, the construction of a ferrocement cistern requires the following working days:

9 m <sup>3</sup> storage capacity =	9 working days for framework
	12 working days for plastering
18 m <sup>3</sup> storage capacity =	21 working days for framework
	27 working days for plastering.

#### WEST JAVA RURAL WATER SUPPLY PROJECT

In the northern coastal plain of West Java, shallow groundwater and surface water are brackish due to seawater intrusion. Approximately 2 million people live without a reliable drinking and domestic water supply. Thus, rainwater cistern systems are considered to be the only feasible solution because they are relatively simple to install with self-help or consumer participation.

**SCOPE OF THE PROJECT.** Since the storage of rain water is relatively expensive, only water for human consumption (drinking and cooking) will be supplied, for which 5 l/capita/day is considered sufficient. Water for washing and bathing will be from available irrigation water or from the brackish, shallow groundwater. The project includes two programs: (1) a government program for government buildings and houses and (2) a self-help program for households.

The government program is intended for office and community buildings and housing complexes. The system construction should be strong, reliable and durable, and the cost no higher than necessary.

The self-help program is intended for rural houses (1 per household). If space is available, cisterns can be built for families in urban areas. The construction of the RWC system for this program should be as inexpensive as possible and geared to poor families, simple and of locally available materials. Requirements for strength and reliability could be lower, since the average owner will care well for his own investment. The program includes a sociological survey of the financial ability of householders to contribute in

the self-help program and of their acceptance of rain water for drinking and cooking.

The technical program is directed to two development activities: a high quality rainwater collector with a 10-m<sup>3</sup> capacity for at least four households and a lower-quality collector with 2 to 5-m<sup>3</sup> capacities for single-houldhold use.

The high-quality RWCs have been built of ferrocement and of brick; the lower-quality of brick, cement without reinforcement, ferrocement, bamboo cement (bamboo reinforcement) and ijuk cement (palm-fibre reinforcement).

PRELIMINARY RESULTS. The experiences and the results gained in the design and construction of the test RWCs started in October 1978 have been reported in IWACO and are summarized below.

RWC of 10 m<sup>3</sup>. The principal design of a 10 m<sup>3</sup> ferrocement RWC is shown in Figure 2 and the total cost in Figure 3. The results of extensive research on the mechanical properties of ferrocement is presented in Table 1. Based on these results, it has been calculated that with reinforcement a wall thickness of 2.5 cm is sufficient; no cracks were observed after the cisterns were filled with water.

Because of its lower cost, ferrocement for RWCs seems most promising for implementation under the government program.

RWC of 2.5 m<sup>3</sup>. The cost of ferrocement RWCs of this size is rather high for the self-help programs.

Ijuk cement which uses palm fibre to replace steel reinforcement (Fig. 4) reduces the cost by about 25% (Fig. 3). Laboratory tests on ijuk cement (Table 1) show that the tensile strength is not much higher than that of cement without reinforcement. One asset is ijuk is its making the mortar more cohesive, thus preventing cracking. One layer of wire mesh is applied to prevent cracks between the wall and the floor joint.

Bamboo-cement RWCs of up to 10 m<sup>3</sup> have already been constructed in various places in Indonesia. Two 2.5 m<sup>3</sup> RWCs of bamboo-cement (4-cm mesh) have been completed in the West Java project area. No problems were encountered. Experiments in treating the bamboo is also part of the program.

Brick RWCs have no constraints but are the most expensive solution after reinforced concrete and fiberglass.

The cost of different materials in relation to the capacity of the storage tanks are shown in Figure 4. Reinforced concrete RWCs of 10 m<sup>3</sup> are three times more expensive than ferrocement, while bamboo-cement cisterns are only about half the cost of ferrocement or nearly one-sixth that of reinforced concrete cisterns. Ijuk-cement cisterns are cheaper but the capacity is limited.



TABLE 1. CONSTRUCTION PROPERTIES OF RAINWATER CISTERNS

Cement Mixture: 1 pc: 2 sand, water cement ratio 0:4;  
sand 0 1 mm, unless specified otherwise

1. Compression, specimen 20 x 20 x 20 cm

Description	Density (kg/m <sup>3</sup> )	Compressive Strength (kg/cm <sup>2</sup> )
Cement Without Reinforcement	2 010	223
	2 070	266
	2 070	276
Bamboo Cement Mass width, 5 cm	2 130	272
	1 940	265
	1 900	144
Ijuk Cement Ijuk, 10 g	1 990	235
	2 020	296
	2 030	205

2. Bending, specimen 30 x 20 x 2.25 cm

Description	Bending Strength (kg/cm <sup>2</sup> )	Deflection (mm)	
Cement Without Reinforcement Thickness, 1 cm	43.0	0.001	
	24.1	0.0	
	45.2	0.0	
	Thickness, 2 cm	32.1	0.0
		33.3	0.001
		33.4	0.125
Bamboo Cement Mass width, 2.5 cm	29.2	0.0	
	30.6	0.002	
	67.6	0.001	
	Mass width, 5.0 cm	37.4	0.032
		36.1	0.0
		35.8	0.030
	Mass width, 7.5 cm	49.3	0.095
		51.3	0.0
		46.3	0.0
Ijuk Cement Thickness, 2.5 cm	37.7	0.0	
	40.7	0.0	
	39.7	0.023	
	Thickness, 5.0 cm	51.5	0.0
		33.2	0.0
		50.1	0.257
	Thickness, 10.0 cm	38.3	0.020
		56.3	0.0
		48.8	0.0
	Thickness, 15.0 cm	69.0	0.001
		35.9	0.0
		38.1	0.052

TABLE 1.—*Continued*

Description	Bending Strength (kg/cm <sup>2</sup> )	Deflection (mm)
Ferrocement		
1 layer wire mesh + reinforcement, 0 2.6-5 cm	133.5	-----
	100.7	-----
	99.0	-----
	67.4	-----
	68.4	-----
	69.5	-----
3. Tension, specimen 8 x 5 x 2 cm		
Description	Tensile Strength After 7 Days (kg/cm <sup>2</sup> )	
Cement Without Reinforcement .....	33.6	25.8
Ijuk Cement		
Ijuk, 1 g .....	25.8	23.8
		22.8
Ijuk, 1.5 g .....	28.0	26.9
		28.0
Ijuk, 2 g .....	29.4	30.6
		32.4

## LATEST DEVELOPMENT

Until June 1981, about 2600 RWC systems have been constructed in Indonesia. Some are made of ferrocement, some of bamboo-cement. The capacities of ferrocement cisterns are 9 to 25 m<sup>3</sup>; bamboo-cement, 4.5 to 10 m<sup>3</sup>. Of the more than 600 RWCs made by villagers, most are of bamboo-cement. This indicates that the RWC systems are accepted for drinking water supply, and, thus, the government has begun to establish more pilot projects on a wider scope.

In villages with very little rainfall, many farm groups have built bamboo-cement RWCs to irrigate their crops. Progress to date is very promising. It is time that engineers should take a more active role in studying and preparing guidelines and standard designs for RWCs.

## CONCLUSIONS AND RECOMMENDATIONS

Not enough attention is given to the design, technology and construction of the RWC system. In general, nearly all systems have been under designed. In the Gunung Kidul area, owners of RWC systems still suffer nearly every year from a shortage of water for drinking, which is unnecessary.

The problem is easy to solve:

1. Revise the design criteria
2. Prepare nomograms for cistern capacities/volumes for potential use areas
3. Prepare standard design drawings of cistern of various capacities made of bamboo-cement and other local materials
4. Prepare guidelines on the design, construction and maintenance of the system.

With these guidelines, village workmen will be self-sufficient in constructing and maintaining their own systems without the help of experts.

## NOTES:

1. As existing roofs are used as catchment areas, the height of the gutter may be a limiting factor; therefore, the reservoir should be placed as high as possible to allow the rain water to flow into the filter structure.
2. Although the quality of water has not been discussed in this paper, it does not mean that no treatment and provision of iodine and lime are done.
3. For more information, write to
 

Water Resources Division  
Civil Engineering Department  
Engineering Faculty  
University of Indonesia  
Salemba 4, Jakarta, INDONESIA

## AUTHOR INDEX

AHMED, Samir A. ....	46	LEUNG, PingSun .....	128
APPAN, Adhityan .....	220	LEUNG, PingSun .....	210
BARKER, Johnny R. ....	368	LIU, Rong-Shun .....	368
BEDIENT, P.B. ....	244	LO, Andrew .....	83
CARDLE, James Angus .....	360	LO, Andrew .....	164
CHOWDHURY, Prabhat K. ....	350	MISHRA, G.C. ....	102
CRASTA, Francesca M. ....	37	MOHAN, Jagdish .....	68
DATTA, Bhaskar .....	102	MURABAYASHI, Edwin T. ....	83
DHAR, O.N. ....	61	MURDIYARSO, D. ....	171
DIAMANT, B.Z. ....	276	NASCIMENTO, Ulpio .....	332
DOELHOMID, Srimoerni .....	387	NGUYEN, Van-Thanh-Van .....	77
DURHAM, Mark T. ....	144	O'MEARA, Christine .....	266
FASSÒ, Costantino .....	37	ÖZİŞ, Ünal .....	9
FERRIS, S.A. ....	377	PATTA, Francesco .....	37
FEWKES, A. ....	377	PERRENS, S.J. ....	108
FOK, Yu-Si .....	46	PERRENS, S.J. ....	308
FOK, Yu-Si .....	83	PIGGOTT, Terry L. ....	144
FOK, Yu-Si .....	128	POMPE, C.L.P.M. ....	151
FOK, Yu-Si .....	164	PUTZU, Giorgio .....	37
FOK, Yu-Si .....	210	RAKHECHA, P.R. ....	61
FOK, Yu-Si .....	227	REID, George W. ....	1
FOK, Yu-Si .....	317	ROMEO, Charles .....	257
FONG, Ronald H.L. ....	83	SCHIEFELBEIN, Ian J. ....	144
FURUKAWA, Seiji .....	118	SCHILLER, Eric J. ....	92
GAONA V., S. ....	54	SETH, S.M. ....	68
GAONA V., Salvador .....	16	SHARPE, William E. ....	249
GONZÁLEZ L., Ernesto .....	16	SHATA, Abdu A. ....	23
GORDILLO, Tuchée .....	16	SIVANAPPAN, R.K. ....	194
GUPTA, Raj Kumar .....	33	SONG, Charles C.S. ....	360
HEGGEN, Richard J. ....	135	STEPHENSON, Rebecca A. ....	158
HOEY, Peter J. ....	284	SUKARNA .....	171
IKEBUCHI, Shuichi .....	118	TERAKAWA, Akira .....	338
INGHAM, Alan Thane .....	323	TIAGI, S.S. ....	68
INMAN, D.V. ....	202	VAN KERKVOORDEN, Ron .....	299
IRISH, J.L. ....	171	VEGA, Silvia .....	54
ISHIZAKI, Katsuyoshi .....	338	WALLER, D.H. ....	184
JONES, R. Anne .....	233	WALLER, D.H. ....	202
KATIYAR, Vidya Sagar .....	33	WEST, Stephen F. ....	284
KING, Thomas L. ....	244	WINARTO .....	294
KLEINE, Charles Franklyn .....	323	WINTER, Stephen J. ....	158
KULKARNI, A.K. ....	61	YOSHINO, Fumio .....	338
KURUSHINA, H. ....	158	YOUNG, Edward S. ....	249
LATHAM, Brian .....	92	ZHENG, Jiaxiang .....	348
LEE, G. Fred .....	233		