



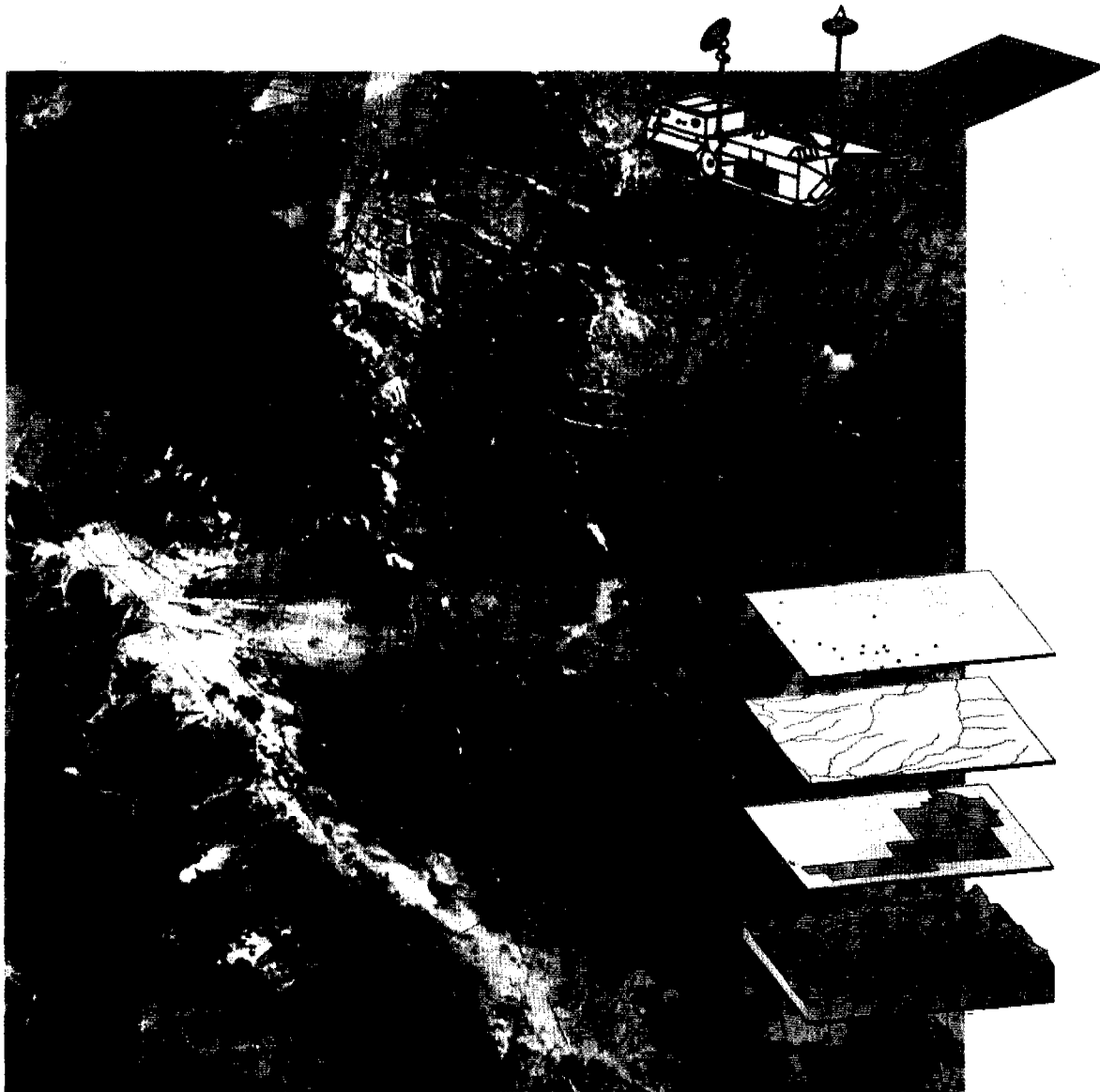
Economic and Social Commission  
for Western Asia



United Nations Environment  
Programme



Royal Jordanian Geographic Centre



**PROCEEDINGS OF THE TRAINING COURSE ON  
USING REMOTE-SENSING DATA AND GIS TECHNIQUES  
IN HYDROLOGY AND HYDROGEOLOGY**

Amman, 2-12 December 1995

212.1-97PR-14789



Distr.  
GENERAL  
E/ESCWA/ENR/1996/6  
5 November 1996  
ORIGINAL: ENGLISH

**ECONOMIC AND SOCIAL COMMISSION FOR WESTERN ASIA**

**PROCEEDINGS OF THE TRAINING COURSE ON USING  
REMOTE-SENSING DATA AND GIS TECHNIQUES  
IN HYDROLOGY AND HYDROGEOLOGY**

**Amman, 2-12 December 1995**



LIBRARY IRC  
PO Box 93190, 2509 AD THE HAGUE  
Tel.: +31 70 30 689 80  
Fax: +31 70 35 899 64

**UNITED NATIONS  
New York, 1997**

BARCODE: 1 4 7 8 9  
LO: 212.1 97PR

## NOTES

The designations employed and the presentation of the material in this publication do not imply the expression of any opinion whatsoever on the part of the Secretariat of the United Nations concerning the legal status of any country, territory, city or area, or of its authorities or concerning the delimitation of its frontiers or boundaries.

Mention of firm names and commercial products does not imply the endorsement of the United Nations.

The views expressed in signed articles are those of the authors and do not necessarily reflect those of the United Nations.

Bibliographical and other references have, wherever possible, been verified.

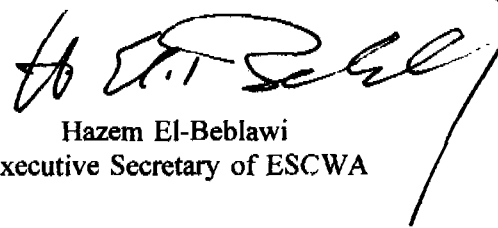
97-0048

## Foreword

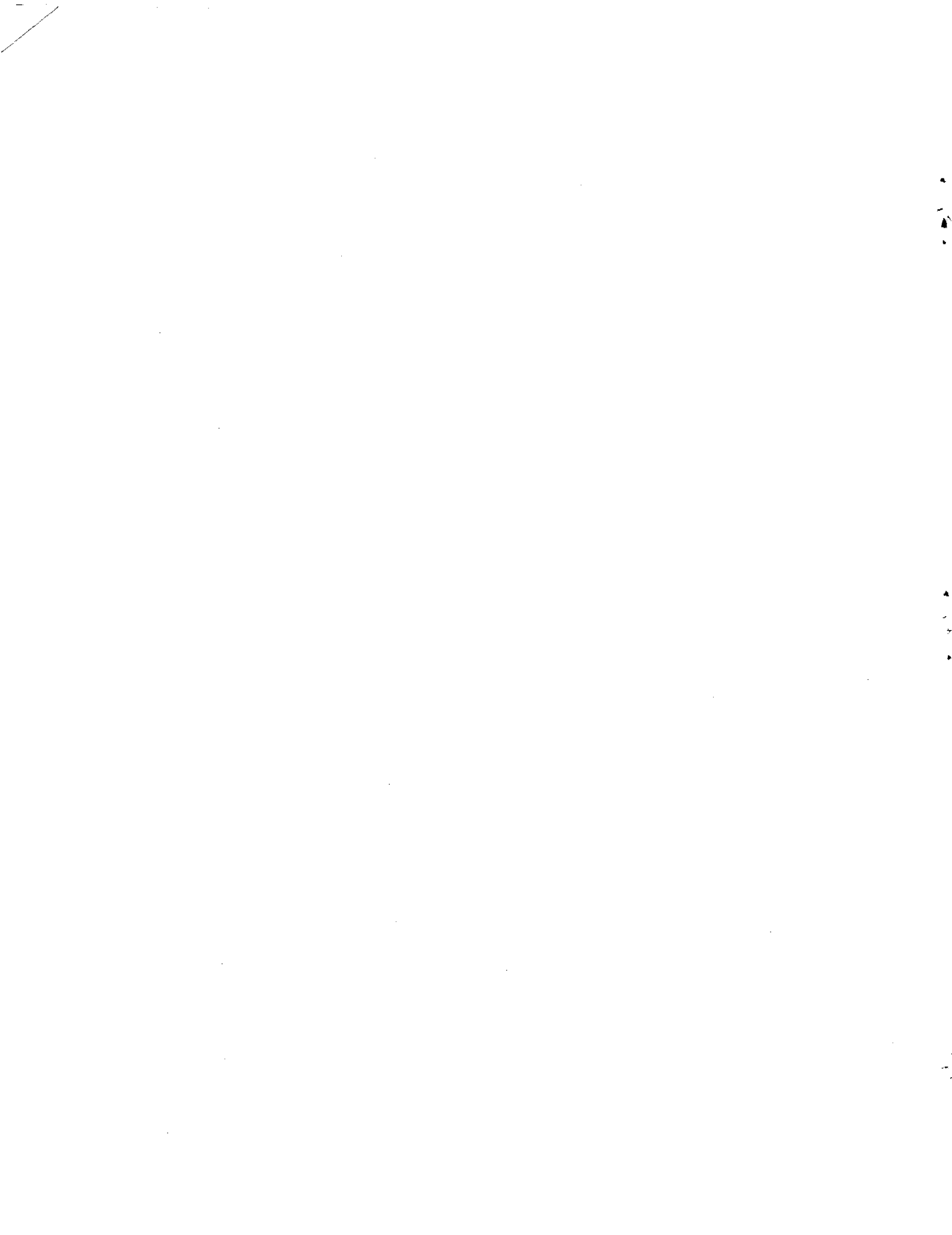
The application of remote-sensing techniques in the field of water resources has contributed to further refinements of the delineation of geomorphological characteristics of major drainage basins, geological lineaments, areal extent of aquifers, natural vegetation cover, and irrigated areas. The use of remote sensing in combination with GIS techniques also strengthens the integration of hydrological and hydrogeological information leading to further assessments of the surface run-off and flow of rivers, groundwater hydraulics characteristics, recharge, and development activities as well as suggestions for the development and management of both surface- and groundwater resources in the ESCWA region.

It is against this background that the ESCWA secretariat took the initiative towards improving the state of knowledge of regional water resources by jointly organizing a training course with the Royal Jordanian Geographic Centre, with financial support from the United Nations Environment Programme. The course was entitled Using Remote-Sensing Data and GIS Techniques in Hydrology and Hydrogeology and was aimed at promoting and enhancing capacity-building through the application of modern technology, including remote-sensing and GIS techniques for thorough assessment, development and management of water resources. The training course represents a significant complementary activity to the project on "Assessment of water resources in the ESCWA region using remote-sensing techniques", which was implemented during the period 1994-1995. The course was designed to provide as much up-to-date information as possible on the remote-sensing and GIS techniques utilized in the assessment of surface- and groundwater resources, as well as the development of hydrological, hydrogeological and land-use maps of the ESCWA region. It also included proposals and ideas needed to promote regional cooperation, especially where the development and management of shared water resources are concerned.

It is my hope that the dissemination of the proceedings of the training programme to a wider audience will allow other parties to share their experiences in the application of modern technology in hydrological and hydrogeological analyses for the development and management of water resources. Perhaps, as a result, sound decisions on the development of future projects can arise from a better understanding of the need for closer international cooperation in this field.



Hazem El-Beblawi  
Executive Secretary of ESCWA



## CONTENTS

	<i>Page</i>
Foreword .....	iii
<b>PART I</b>	
<i>Chapter</i>	
I. Organization of work .....	3
II. Organization of the course .....	4
III. Course evaluation .....	4
IV. Summary of the course .....	5
<b>PART II</b>	
V. Remote-sensing: platforms and sensors, by Hamid Al-Naimiy .....	9
VI. Basic principles of remote sensing, by Omar Malkawi .....	22
VII. Geographical information systems, by Muneer Qudaisat .....	25
VIII. The concept of data integration (RS, GIS, and related field data), by Omer Al-Qudah .....	32
IX. Hydrogeological maps using GIS (Arc/Info), by Ghazi Qussous .....	37
X. Analysis of remote-sensing data through GIS software, by Rafe Ashour .....	43
XI. Digital image processing, by Samih Rawashdeh .....	46
XII. Project planning and design using new techniques (RS and GIS) by Salem Al-Hussein .....	57
XIII. Monitoring of rainfall and evapotranspiration variability in time and place, by Ali Sa'ad .....	61
XIV. Development of vegetation and land use in the ESCWA region, by Hussein Harahsheh .....	70
XV. Soil moisture and soil erosion, by Munther Karraz .....	80

## CONTENTS (continued)

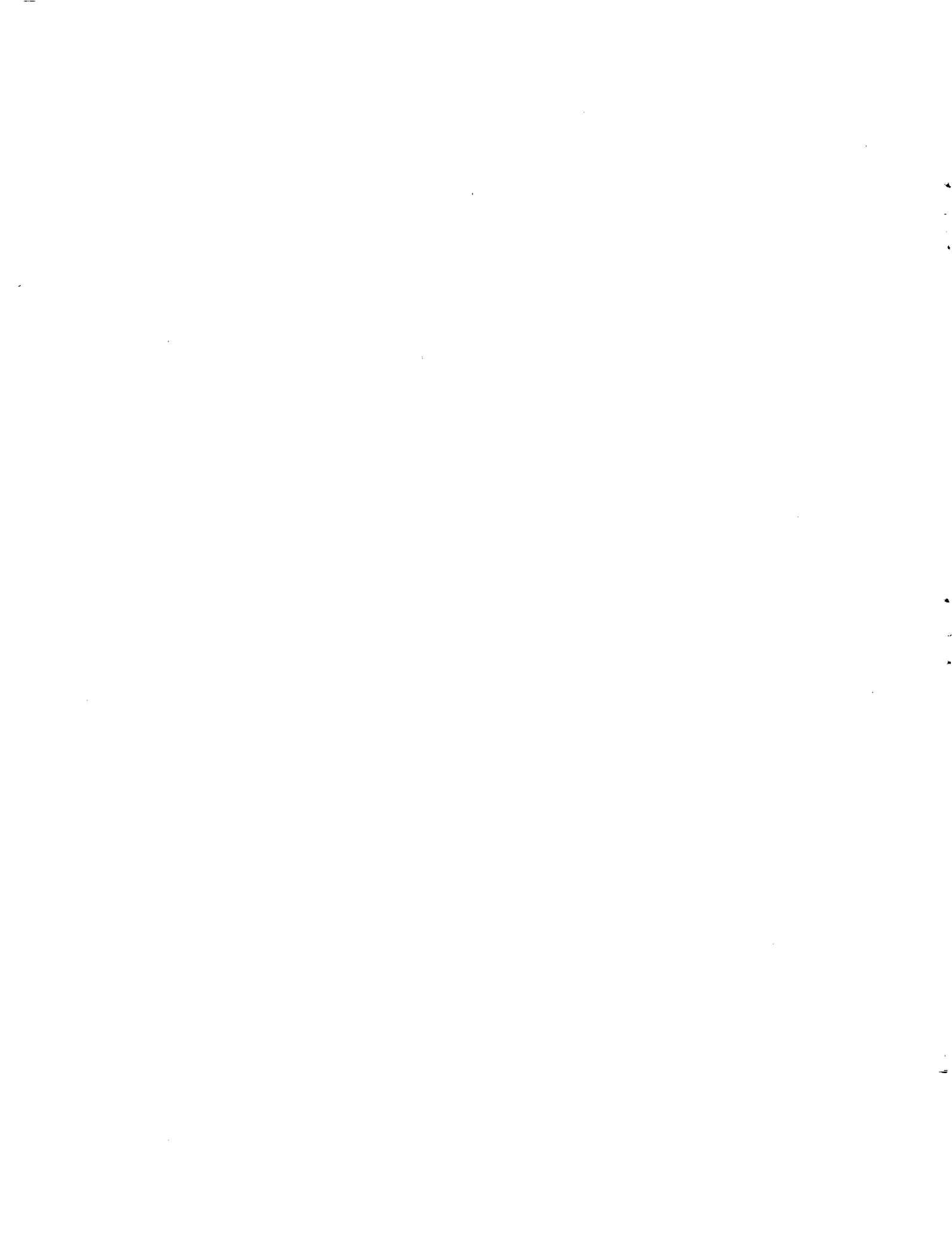
	<i>Page</i>
XVI. Surface-water bodies and catchment characteristics, by Mohammed Shatanawi .....	90
XVII. Shared surface water in the ESCWA region, by Mohamed El-Sallag .....	96
XVIII. Major geological lineaments, by Mufid Hamza .....	118
XIX. Principles of groundwater evaluation of crystalline aquifers, by A.N. Charalambous .....	126
XX. Hydrogeological overview of aquifer systems in the ESCWA region, by A.N. Charalambous .....	129
XXI. Major shared groundwater basins in the ESCWA region: Hydrogeology and hydrochemistry, by A.N. Charalambous .....	141
XXII. The potential feasibility of development and management strategies for the major groundwater basins of the ESCWA region, by A.N. Charalambous .....	148
XXIII. Groundwater quality problems in the ESCWA region and the possible use of satellite images for the development of groundwater protection strategies, by Wolfgang Wagner .....	159
XXIV. Recharge and quantities, calculations of sustainable yields of groundwater, by Radwan Al-Wishah .....	166
XXV. Landsat Thematic Mapper imagery of the Cenozoic volcanic field of Jordan and the Syrian Arab Republic, by Uwe Schaffer .....	176
XXVI. Aspects of the geological evolution of the south-western part of the Arabian plate: the results of geological mapping in the Republic of Yemen, by Uwe Schaffer ...	180

## ANNEXES

I. List of participants .....	187
II. Programme of work .....	191
III. Questionnaire .....	195



# **PART I**



## I. ORGANIZATION OF WORK

The Training Course on Using Remote-Sensing Data and GIS Techniques in Hydrology and Hydrogeology was held in Amman from 2 to 12 December 1995. The course was jointly organized by the United Nations Economic and Social Commission for Western Asia (ESCWA) and the Royal Jordanian Geographic Centre (RJGC) with financial support from the United Nations Environment Programme (UNEP). The course was a major component of the ongoing ESCWA/UNEP project on the "Assessment of water resources in the ESCWA region using remote-sensing techniques". It also served as a follow-up of activities leading towards the implementation of recommendations set forth in chapters 18 and 36 of Agenda 21, dealing with the transfer and application of modern technology and promotion of training for water resources assessment, development and management.

The main objective of the training course was to strengthen the technical capabilities of water specialists from ESCWA member States through the application of remote-sensing technology and GIS software for optimal assessment, monitoring and management of water resources in the ESCWA region. The purpose was also to heighten awareness of the many benefits of these techniques in water studies. Designated government specialists from member States with backgrounds in fields related to the course content who were involved in water resource assessment and/or management in their respective countries were invited to attend as trainees (annex I contains the list of participants).

The course documents, prepared by the staff of the Royal Jordanian Geographic Centre, ESCWA and local consultants, consisted of a set of training materials addressing the fundamentals of remote-sensing techniques and GIS software. The course programme also involved activities addressing the application of these techniques through the processing and analysis of data for the purpose of water resources assessment and management in the ESCWA region (annex II contains a list of training course topics).

The course was convened under the auspices of the Secretary-General of the Ministry of Water and Irrigation of Jordan, on behalf of H.E. the Minister of Water and Irrigation. The opening ceremony began with welcoming statements delivered by the Director-General of the Royal Jordanian Geographic Centre and by the Chief of the ESCWA Energy, Natural Resources and Environment Division. Each speaker emphasized that the meeting was one of the major concluding steps of the ESCWA/UNEP project, the goal of which was the improvement of the state of knowledge of water resources, with emphasis on shared water sources within the ESCWA region, through the application of innovative technologies. They stressed that the course was designed to provide an opportunity for participants to become familiar with the use of satellite remote-sensing and GIS techniques in the assessment of surface- and groundwater resources, and the development of hydrological, hydrogeological and land-use maps of the ESCWA region. They also expressed their appreciation to UNEP for its financial support of the training course.

The Chief of the ESCWA Energy, Natural Resources and Environment Division stressed the need for improved regional cooperation within the water sector in order to avoid duplication of efforts and fragmented water studies. He highlighted the contributions of the application and transfer of innovative technology, including remote sensing and GIS assimilation, as well as analysis and display of multi-sectoral information, towards the development and management of water resources in the ESCWA region.

The Secretary-General of the Ministry of Water and Irrigation of Jordan reflected on the importance of the course objectives and concurred with the views expressed by the Chief of the ESCWA Energy, Natural Resources and Environment Division. He concluded with a call to strengthen capacity-building at all levels including decision-making in the water sector through extensive training programmes and workshops that would emphasize the application of modern technology in hydrological and hydrogeological analyses in order to optimize local and regional water utilization in all sectors.

## II. ORGANIZATION OF THE COURSE

ESCWA sent invitations to each member State requesting that two participants be nominated to attend the training course. Candidates were to be actively involved in the assessment, planning and management of water resources in their respective countries. The course was attended by 17 participants (trainees) from ESCWA member States with diverse academic and technical backgrounds, including remote-sensing and GIS technology. Funds allocated by UNEP covered participants' expenses. The course was held at the Royal Jordanian Geographic Centre, and its organization was carried out in coordination with ESCWA. The RJGC provided technical equipment, materials, lecture halls and local transportation.

The training session began with a general lecture by the Senior Officer of the ESCWA Natural Resources Section, in which the scope and objectives of the training course were outlined. He stressed the need for timely dissemination of knowledge on remote-sensing and GIS technology and elaborated on their potential contribution towards enhancing the assessment, development and planning processes in the water sector within the ESCWA region. Instructions for both technical lectures and practical laboratory exercises were prepared by 19 experts from ESCWA and RJGC specializing in the subjects covered in the training course. The trainees were provided with an extensive set of training materials.

The course consisted of a series of one-hour morning lectures followed by three-hour practical laboratory sessions in the afternoon. Special emphasis was placed on practical exercises and case-studies selected from the ESCWA/UNEP project involving the use of remote-sensing hardware and GIS software in the development of different-sized regional hydrological, hydrogeological and land-use maps.

Several topics were covered during the course: the fundamentals of remote-sensing; sensors and platforms; digital processing; GIS software; integration of remote-sensing; GIS and hydrological data; and conventional hydrological and hydrogeological tools. A major part of the course time was devoted to the application of remote-sensing techniques and GIS software in the assessment of surface- and groundwater resources in the ESCWA region, including the delineation of major geomorphological features, surface-water bodies, geological rock units and lineaments, and the areal extent of major aquifers and their associated recharge areas. Particular emphasis was placed on water sources shared among some of the member States. At the conclusion of the course, each participant received a certificate of completion.

## III. COURSE EVALUATION

At the end of the course, the participants were asked to complete a survey questionnaire for the purpose of evaluating the appropriateness and effectiveness of the training programme as well as the knowledge gained (a sample questionnaire is shown in annex III). The participants acknowledged the contribution of the training programme towards the improvement of their technical capabilities through the introduction and application of modern remote-sensing and GIS technology, as well as the exchange of information on water resources in the ESCWA region. They expressed satisfaction with the topics covered during the course and the appropriateness of those topics in assessing, monitoring and managing water resources. They indicated, however, a preference for greater emphasis on practical, hands-on application rather than technical presentations. Most participants expressed a preference for individual or group case-studies, to be conducted by the trainees, on relevant local or regional water problems. A majority of participants were of the opinion that more training time should be devoted to the development of personal computer skills for use with satellite data and GIS software in water studies.

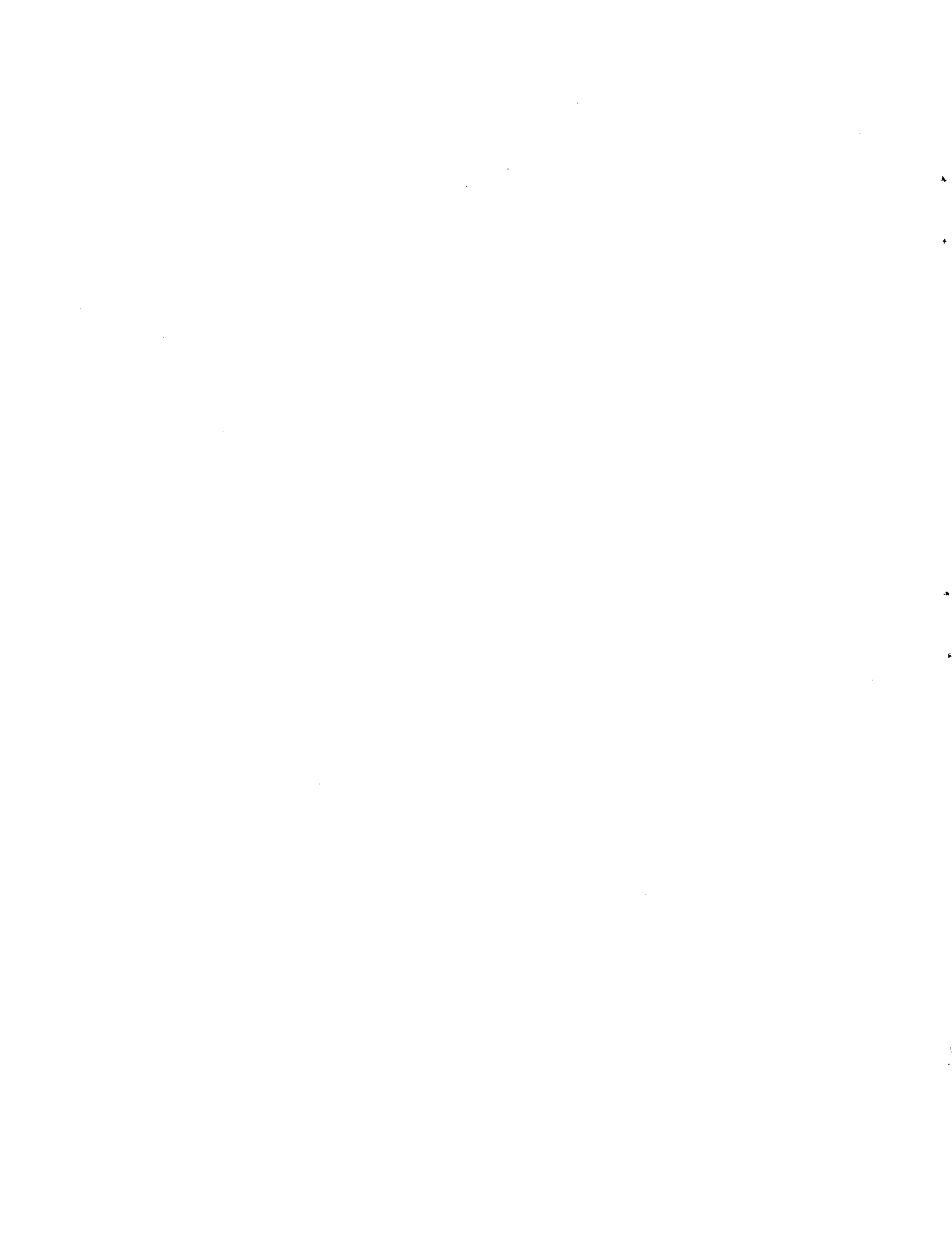
In general, the participants agreed that remotely sensed imagery, in combination with GIS and hydrogeological data, were important foundations in formulating a database that could be used by planners and decision makers to develop and manage water resources in the ESCWA region. Participants indicated

that remote-sensing, GIS, hydrological and hydrogeological databases were currently being used, or were in the process of being developed for use, in the assessment and management of water resources in their respective countries.

#### IV. SUMMARY OF THE COURSE

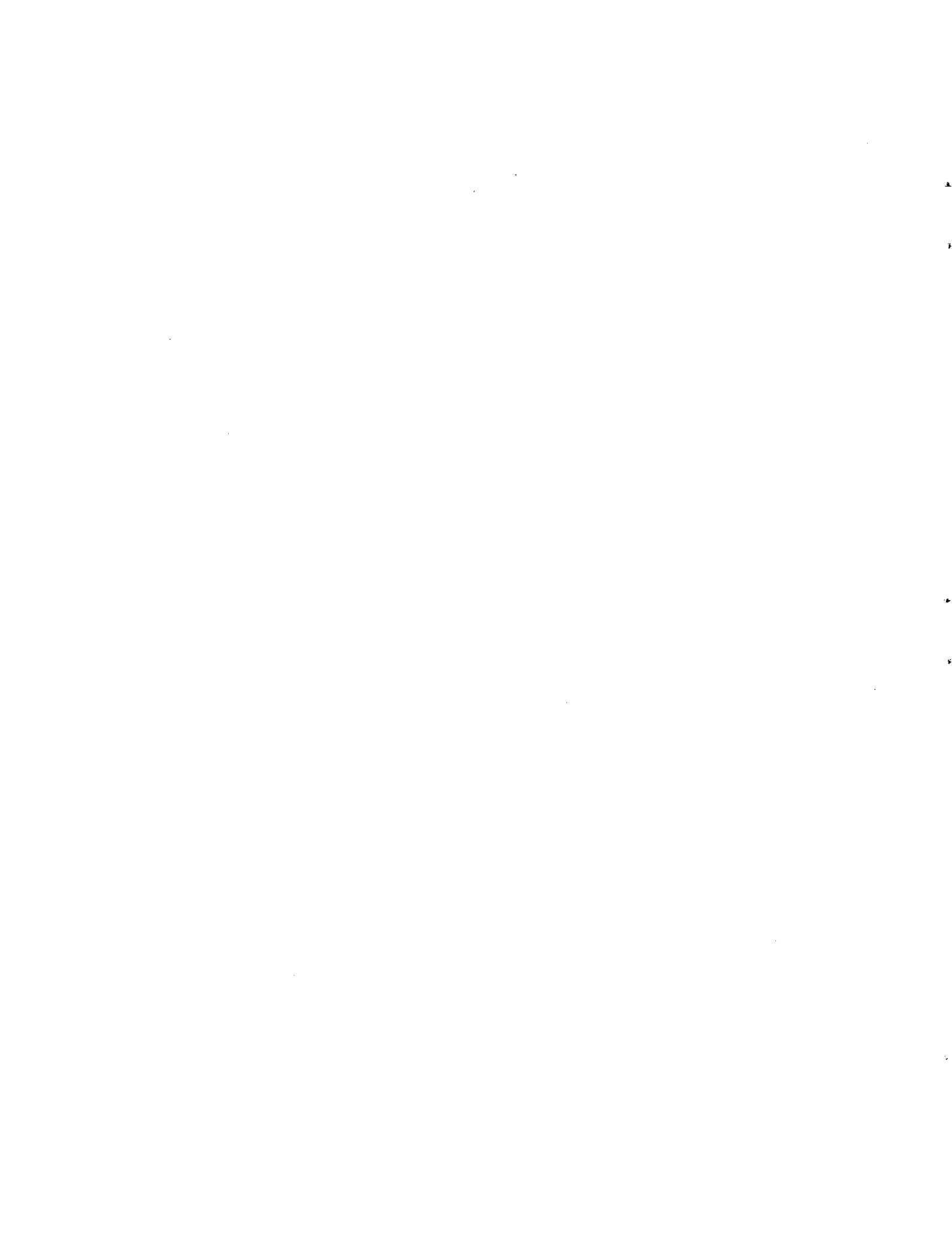
The course participants acknowledged with appreciation the efforts made by ESCWA and RJGC in organizing and hosting the training course. They expressed satisfaction with the scientific and technical quality of the course. They acknowledged the need for organizing additional training courses which would emphasize the application of the innovative technology needed for the effective management and efficient utilization of the scarce water resources in their countries and in the ESCWA region. The course programme highlighted the technical merits of using remote-sensing and GIS techniques, in combination with hydrological and hydrogeological data, to enhance the body of knowledge about water resources in the ESCWA region. The hands-on demonstration of various remote-sensing and GIS tools in the development of hydrological and hydrogeological maps of the ESCWA region indicated the effectiveness and suitability of such tools in mapping and making inventories of surface- and groundwater resources in the region, especially shared water sources.

The course provided an opportunity for technical discussions, the exchange of ideas and the dissemination of information on regional water resources among the participants. The exchange of information about water resource problems within the member States could facilitate cooperation and coordination at the subregional and regional levels. The course stimulated the interest of participants and facilitated the transfer of knowledge concerning modern technology and the wider application of remote-sensing and GIS techniques in water resource assessment and management in their respective countries. The training programme will promote a greater awareness of the extent of water resource scarcity in the ESCWA region as well as utilization and management problems that are inherent in such water shortages.



**PART II**

*Lectures*





## V. REMOTE-SENSING: PLATFORMS AND SENSORS

by

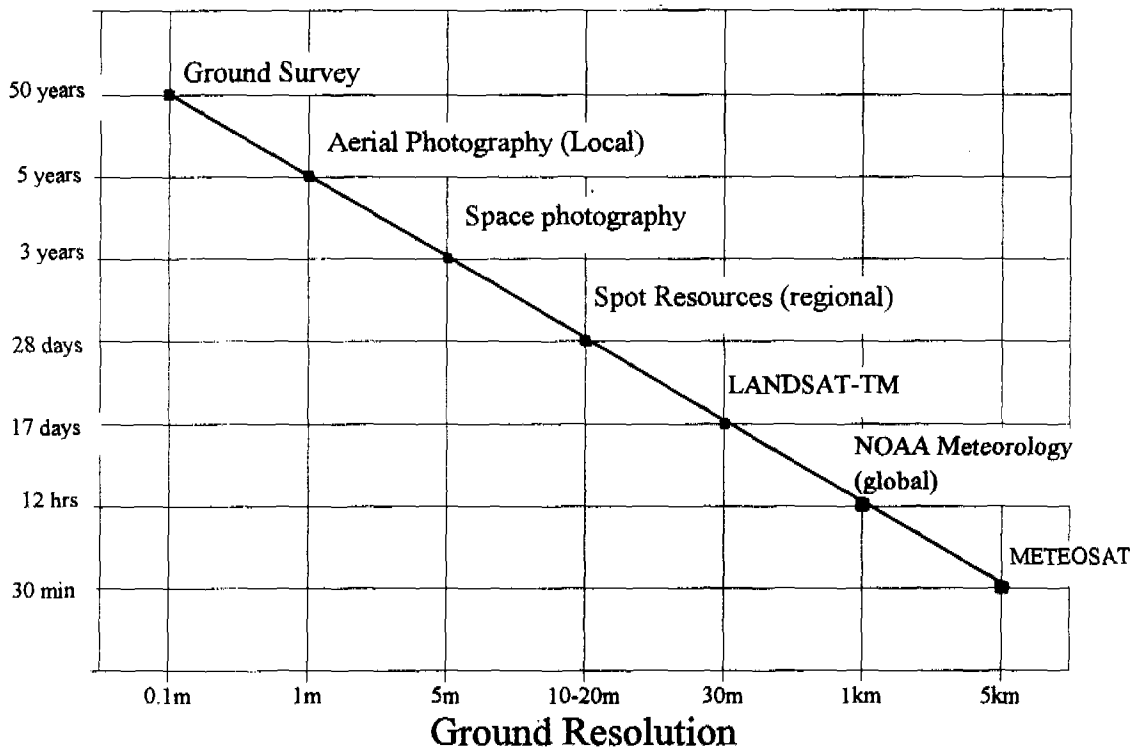
*Hamid Al-Naimiy\**

### Introduction

Remote-sensing technology (platforms, sensors and satellites) is expanding at a rapid and exciting pace. In the last three decades, the technology used in the earth's natural resources satellites has progressed from experimental and limited to operational and global. The next decade will witness more operational satellite systems for earth observation with developments such as the polar platform and imaging radar system. By the next century, the earth will be closely and continuously monitored by a band of satellites and sensors in space. A large number of remote-sensing satellites have been launched since 1960 because the capabilities of many of the earlier satellites had been significantly superseded.

The progression is from low spatial resolution systems, such as the geostationary weather satellites to the highest spatial resolution systems expressed in the Landsat Thematic Mapper. The SPOT HRV and the satellites with a low spatial resolution (5 km pixels) commonly produce two images per hour of the same area, while the Landsat Thematic Mapper can produce a maximum of one image of the same area every 16 days. This trade-off between spatial and temporal resolution is an important characteristic of satellite remote-sensing and has a significant effect on the applications that are suitable for the different data sources. Resolution and repeatability of different remote-sensing systems is shown in figure I.

**Figure I. Remote-sensing systems and their resolution**



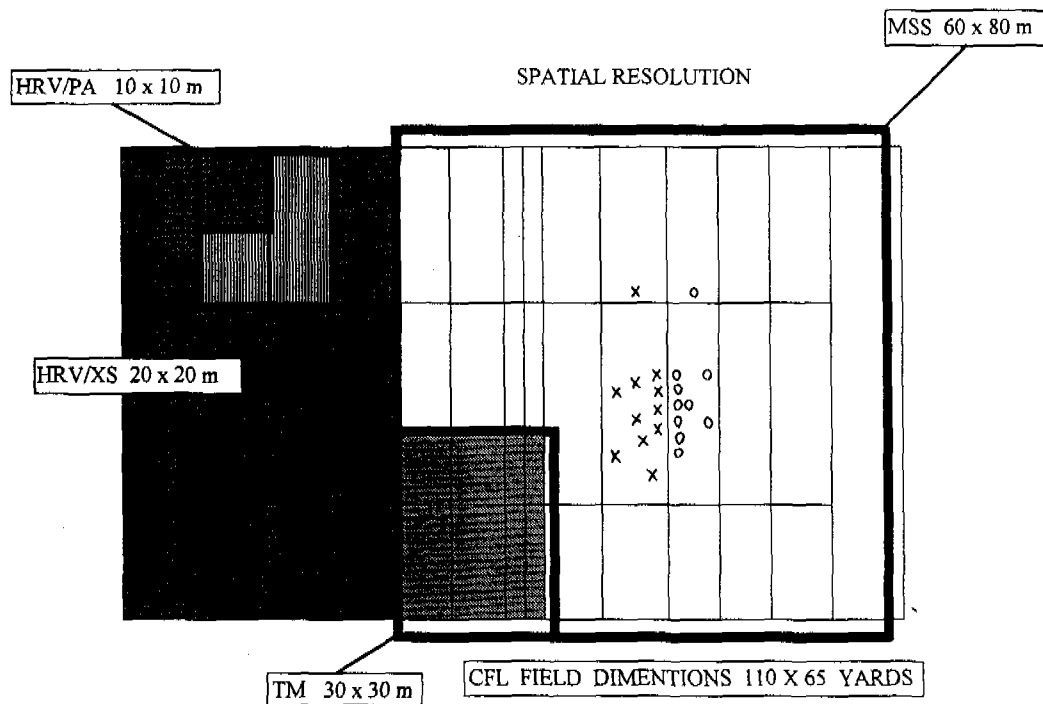
\* The author works at the Institute of Astronomy and Space Sciences, Al al-Beit University, Jordan.

Two principal orbit types are available to the designers of satellite remote-sensing missions: polar orbit and geostationary orbit. The polar orbit is normally a low earth orbit, where satellites fly at altitudes of 200 to 1,000 km, viewing a swath of the earth's surface below. The orbit takes the satellite over or near the North and South Poles. It is in the plane of the sun or sun-synchronous, meaning that the orbit remains in a constant plane relative to the sun while the earth spins below. On each satellite orbit, the earth has rotated below the spacecraft (30° of longitude), so a coverage of the globe can be obtained by successive orbits. A list of operational satellite remote-sensing systems is shown in table 1. Detailed descriptions of the main satellite systems, Landsat and SPOT, usually used in natural resources studies, are shown in figure II and tables 2 and 3.

TABLE 1. OPERATIONAL SATELLITE REMOTE-SENSING SYSTEMS

	Meteorology	Resources	Cartography
United States of America	GOES		(LFC)
GUS	NOAA	Landsat	KFA 1000
France	METEOR	MKF 6	SPOT P
ESA		SPOT-MX	
Japan	METEOSAT	ERS-1	
India	GMS	MOS	
China	INSAT	IRS-1	
Germany		Satellite-Photography	(MC) STEREO MOMS

Figure II. Satellite imagery resolution



Source: RJGC, Canada-Jordan Remote Sensing Project, Training Manual (Amman, 1989).

TABLE 2. PRINCIPLES OF REMOTE-SENSING

Landsat			SPOT				
SENSORS:		705 km	ALTIMITUDE		822 km	SENSORS: HRV (X2)	
		99 min.	PERIOD		101.4 min.		
Thematic Mapper-TM		98°	INCLINATION		99°	MODES:	
6 bands - 30 x 30 m		233	NUMBER OF PATHS		269	Multispectral	
1 band - 120 x 120 m		16 days	EARTH COVERAGE		26 days	3 Bands - 20 x 20 m	
Multispectral Scanner - MSS		185 km	SWATH		60 km/imager	Panchromatic	
4 bands-60 x 80 m		09:45	EQUATOR CROSSING		10:30	1 band - 10 x 10 m	
MSS1	0.5-0.6	GREEN	TM1	0.45-0.53	BLUE	HRV/PADPCM	0.51-0.73 Panchromatic
MSS2	0.6-0.7	RED	TM2	0.52-0.57	GREEN		
MSS3	0.7-0.8	NEAR-IR	TM3	0.63-0.96	RED	HRV/MLA	
MSS4	0.8-1.1	NEAR-IR	TM4	0.76-0.90	NEAR-IR	HRV1	0.50-0.59 GREEN
			TM5	1.55-1.75	SWIR	HRV2	0.61-0.68 RED
			TM7	2.08-2.35	SWIR	HRV3	0.79-0.89 NEAR-IR
			TM6	10.8-12.5	TIR		

Source: RJGC, Canada-Jordan Remote-Sensing Project, Training Manual (Amman, 1989).

\* Reproduced as submitted.

TABLE 3. NOAA-AVHRR (ADVANCED VERY-HIGH-RESOLUTION RADIOMETER)\*

ORBIT	SPECTRAL BANDS
ALTITUDE: 833 km FOV: 1,100 m SWATH WIDTH: 2,400 km REPEAT CYCLE: 12 hrs.	Channel 1: 0.55 - 0.68 Channel 2: 0.725 - 1.10 Channel 3: 3.55 - 3.92 Channel 4: 10.5 - 11.5 Channel 5: 11.0 - 12.5

Data from the AVHRR are available in 5 operational modes:

- 1: AUTOMATIC PICTURE TRANSMISSION (APT) - direct readout to worldwide ground stations of APT visible and IR bands at 4km spatial resolution.
- 2: HIGH RESOLUTION PICTURE TRANSMISSION (HRPT) - direct readout to worldwide ground stations of GRPT data for all spectral channels (1.1 km resolution).
- 3: GLOBAL AREA COVERAGE (GAC) - global on-board recording of 4 km resolution data from all spectral bands.
- 4: LOCAL AREA COVERAGE (LAC) - on-board recording of data from selected portions of any orbit at 1.1 km resolution in all spectral channels.
- 5: GLOBAL VEGETATION INDEX (GVI) - A NOAA/NESDIS product available since April 1982 produced for GAC 4 km AVHRR data.

Source: JARS, Remote-sensing note, Tokyo, 1993.

\* Reproduced as submitted.

## A. DEFINITIONS

Remote-sensing is the science and art of obtaining useful information about an object, area or phenomenon through the analysis and interpretation of image data acquired by a device that is not in contact with the object, area or phenomenon under investigation (Simonett, 1983). Another definition of remote-sensing is the following:

*The acquisition of data and derivative information about objects or materials (targets) located at the earth's surface or in its atmosphere by using sensors mounted on platforms located at a distance from the targets to make measurements (usually multispectral) of interactions between the targets and electromagnetic radiation (RJGC, 1989).*

Remote-sensing techniques and their applications in different scientific fields, including hydrology and water resources management, can be addressed through the following components:

- (a) An understanding of the concept of remote-sensing;
- (b) The relationship between energy and the remotely sensed data;
- (c) Principles of satellite imagery;
- (d) Principles of visual interpretation;
- (e) Digital analysis and its integration;
- (f) Project planning and risk management.

Aircraft and satellites are the most common platforms for remote-sensing observations. Satellite remote-sensing is the use of sensors, normally operating at wavelengths from the visible 0.4  $\mu\text{m}$  to the microwave 25 cm, mounted on satellites to collect information about the earth's atmosphere, oceans, land and ice surfaces (earth natural resources). Commonly, the information is collected in two-dimensional form either as a photographic image, such as the high-resolution images from the Metric Camera carried on the American space shuttle, or as an array of digital data. In atmospheric and oceanographic applications, the data collection may be one-dimensional (for example, the vertical temperature profile of the atmosphere).

Remote-sensing involves the investigation of energy, its characteristics, organization and interaction. For this investigation to be of practical value, it must yield information concerning the nature and properties of a target on the earth's surface. The target is imaged against the background with which it contrasts to a greater or lesser degree. The target is identified in terms of its characteristic spectral response to the energy that it receives. This energy is captured for analysis by a sensor carrier on platforms above the earth's surface.

Remote-sensing satellites orbit the earth at a variety of altitudes, from low polar (200 km) to high equatorial (36,000 km), and their sensors gather electromagnetic energy reflected, emitted or backscattered from part of the earth-atmosphere system below the satellite (see figure III).

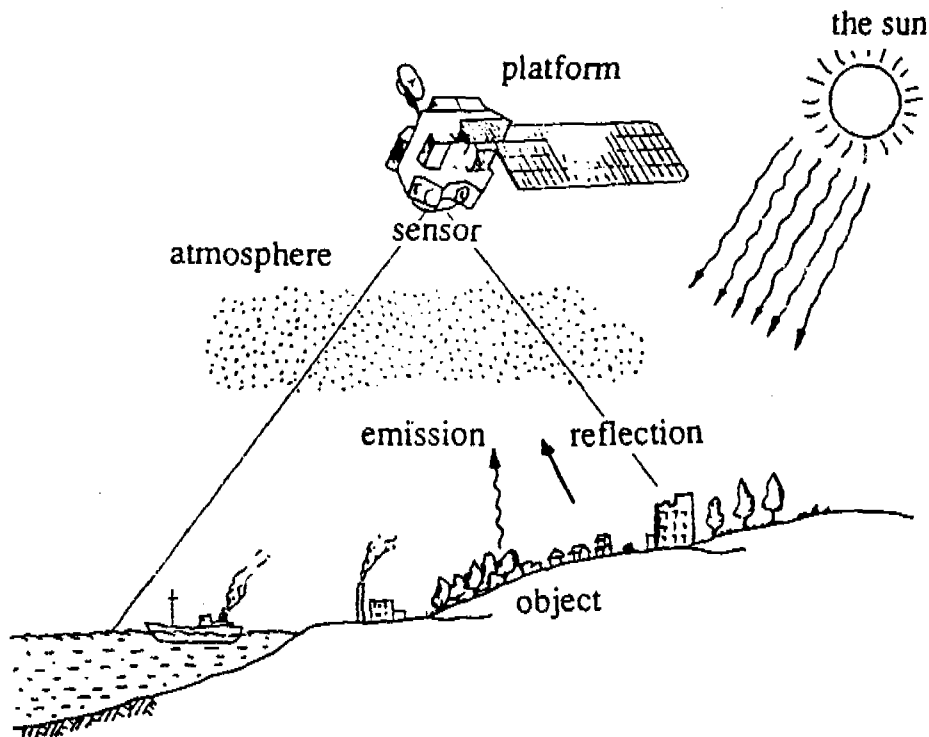
## B. ENERGY SOURCE

The source of energy for remote sensing is the sun. However, the energy of the sun is not evenly distributed by wavelength. The amount of solar energy reaches a peak in the wavelength range of 0.4 to 0.7 micrometres. The visible wavelength is the part of the energy spectrum in which human eyes function best. Table 4 shows the classification of electromagnetic radiation, while figure IV shows the bands used in remote-sensing, and figure V shows the visible and infrared regions, the microwave region and the atmospheric windows. The wavelength bands of commonly used remote-sensing systems are indicated. The

earth's atmosphere absorbs energy in the gamma-ray and X-ray regions and most of the ultraviolet region; therefore, these regions are not used for remote-sensing.

Remote-sensing records energy in microwave, infrared and visible regions as well as the long-wavelength portion of the ultraviolet region. The horizontal axes show wavelength on a logarithmic scale; the vertical axes show the percentage of atmospheric transmission of electromagnetic energy. Wavelength regions with high transmission are called atmospheric windows and are used to acquire remote-sensing images. The major remote-sensing regions (visible, infrared and microwave) are further subdivided into bands, such as the blue, green and red bands of the visible region.

**Figure III. Data collection by remote-sensing**



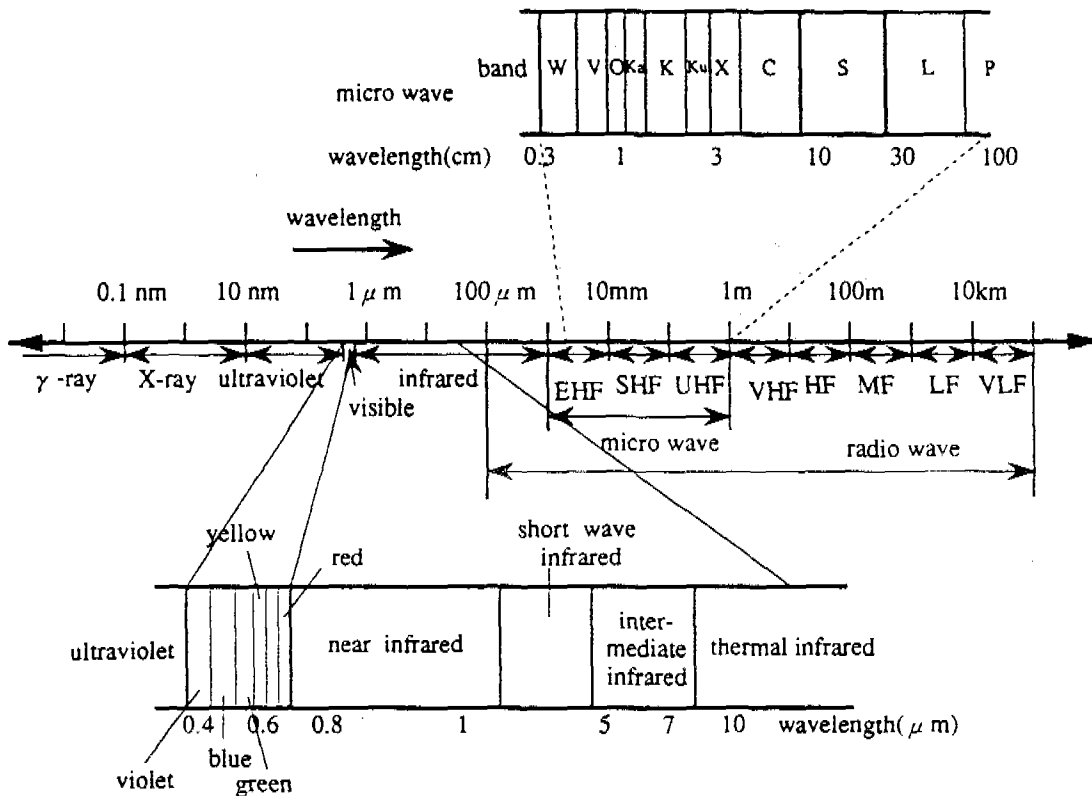
Source: JARS, Remote-sensing note (Tokyo, 1993).

Passive remote-sensing systems record the energy that naturally radiates or reflects from an object. An active system supplies its own source of energy, directing it at the object in order to measure the energy returned. Flash photography is an example of active remote-sensing, in contrast with available-light photography, which is passive. The other common form of active remote-sensing is radar, which provides its own source of electromagnetic energy at microwave wavelengths. Figure VI shows the three types of remote-sensing with respect to wavelength region, while figure VII shows the flow of remote-sensing, from the electromagnetic properties of objects to the affecting factors, to observation by sensor and information extraction to the applications.

TABLE 4. CLASSIFICATION OF ELECTROMAGNETIC RADIATION

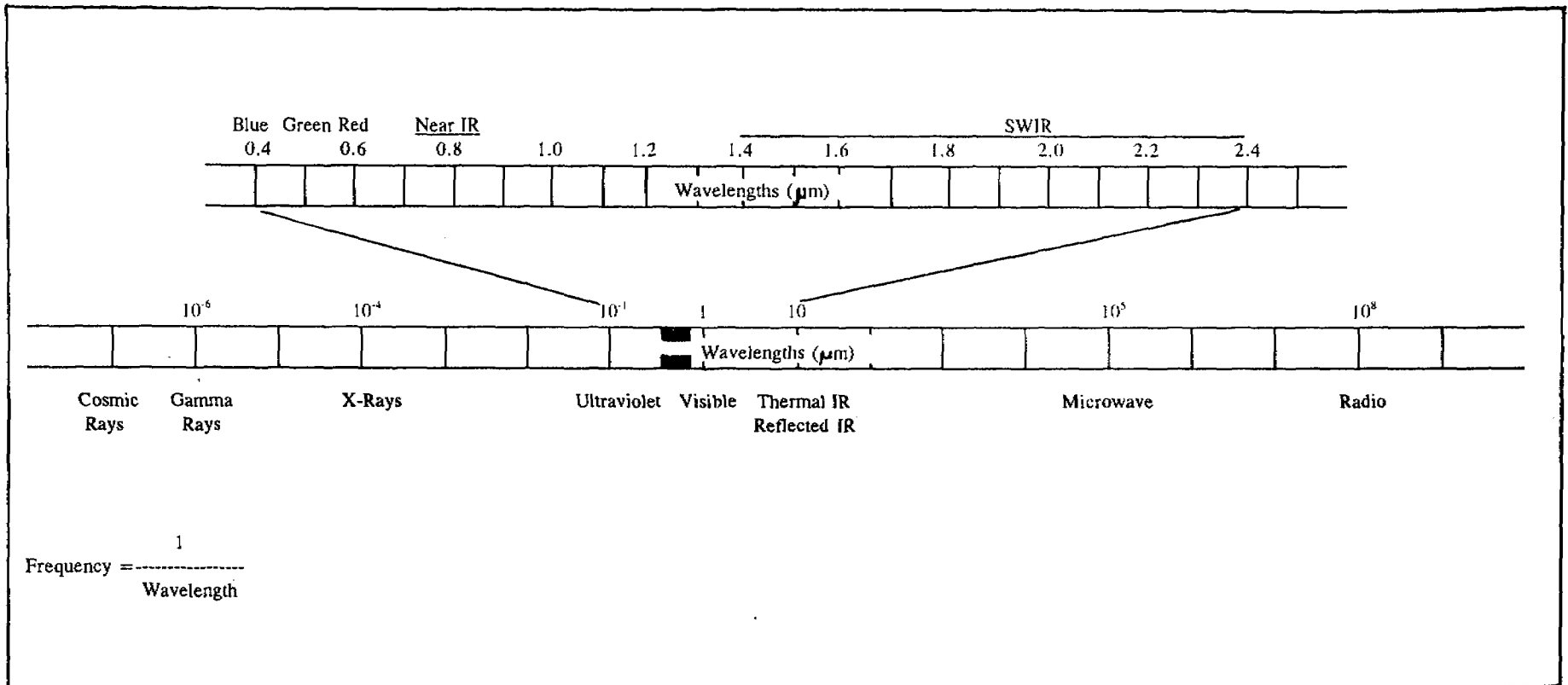
Class		Wavelength	Frequency	
Ultraviolet		100Å - 0.4 μm	750 - 3,000 THz	
Visible		0.4 - 0.7 μm	430 - 750 THz	
Infrared	Near infrared	0.7 - 1.3 μm	230 - 430 THz	
	Short wave infrared	1.3 - 3 μm	100 - 230 THz	
	Intermediate infrared	3 - 8 μm	38 - 100 THz	
	Thermal infrared	8 - 14 μm	22 - 38 THz	
	Far infrared	14 μm - 1 mm	0.3 - 22 THz	
Radio wave	submillimetre	0.1 - 1 mm	0.3 - 3 THz	
	Microwave	millimetre (EHF)	1 - 10 mm	30 - 300 GHz
		centimetre (SHF)	1 - 10 cm	3 - 30 GHz
		decimeter (UHF)	0.1 - 1 m	0.3 - 3G Hz
	Very short wave (VHF)	1 - 10 m	30 - 300 MHz	
	Short wave (HF)	10 - 100 m	3 - 30 MHz	
	Medium wave (MF)	0.1 - 1 km	0.3 - 3 MHz	
Long wave (LF)	1 - 10 km	30 - 300 kHz		
Very long wave (VLF)	10 - 100 km	3 - 30 kHz		

Figure IV. The bands used in remote-sensing



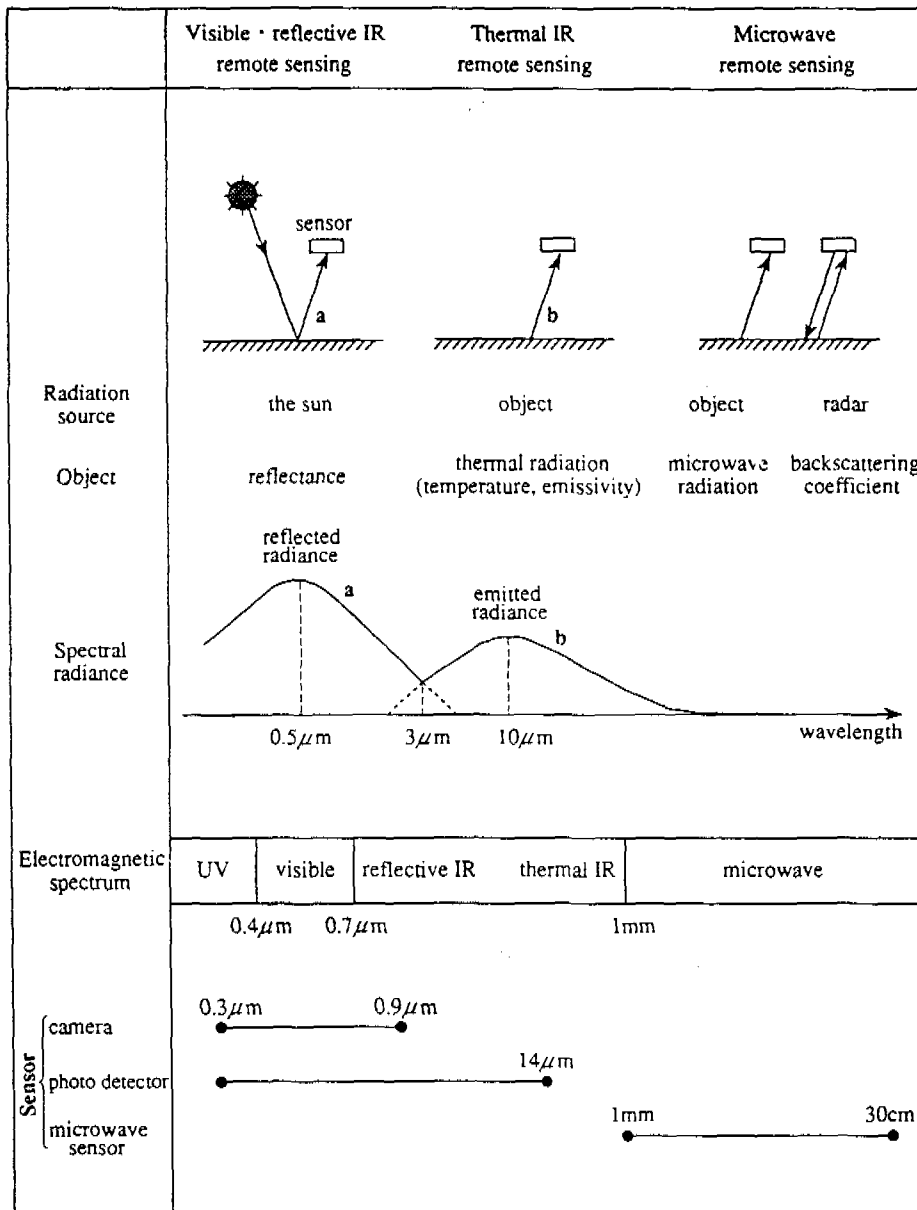
Source: After JARS, Remote-sensing note (Tokyo, 1993).

Figure V. The electromagnetic spectrum



Source: After RJGC, Canada-Jordan Remote-Sensing Project, Training Manual (Amman, 1989).

**Figure VI. Types of remote-sensing information with respect to wavelength regions**



Source: After JARS, Remote-sensing note (Tokyo, 1993).

### C. REMOTE-SENSING SYSTEMS

The inorganic remote-sensing systems belong to two major categories: framing systems and scanning systems.

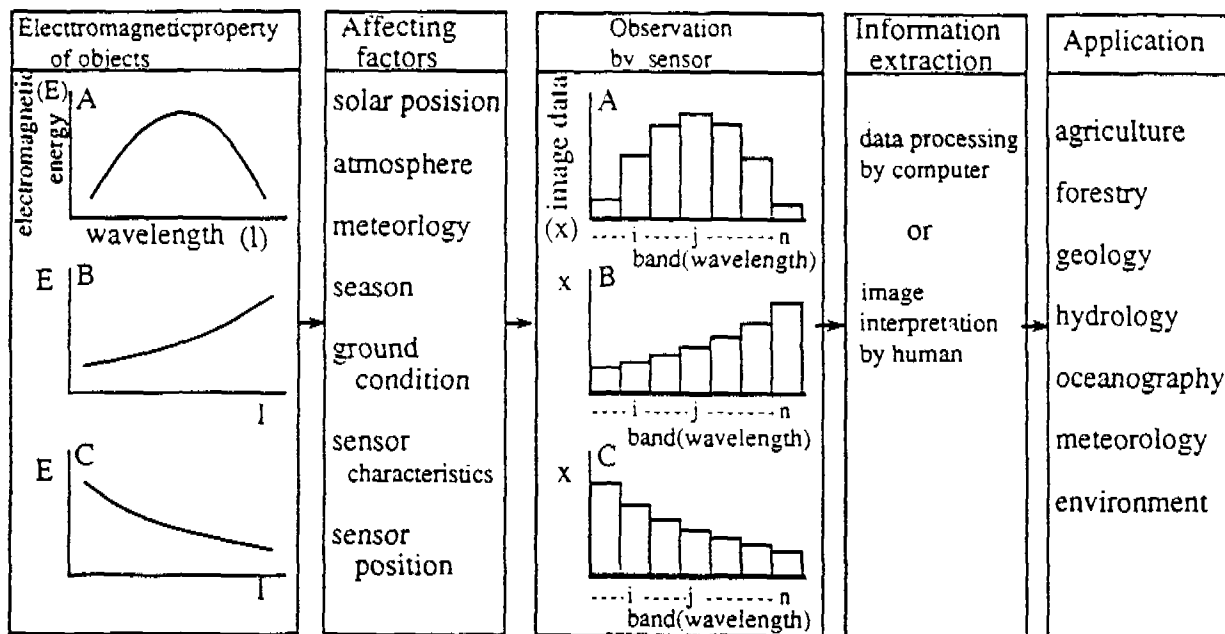
#### 1. Framing systems

This system instantaneously acquires an image of an area, or frame, on the terrain. Cameras and vidicons are common examples of such systems (see figure VIII). A camera employs a lens to form an



image of the scene at the focal plane. A shutter opens at selected intervals to allow light to enter the camera, where the image is recorded on photographic film. A vidicon is a type of television camera that records the image on a photosensitive electronically charged surface. An electron beam then sweeps the surface to detect the pattern of charge differences that constitutes the image. The electron beam produces a signal that may be transmitted and recorded on magnetic tape for eventual display on film.

Figure VII. Flow of remote-sensing information processing



Source: After JARS, Remote-sensing note (Tokyo, 1993).

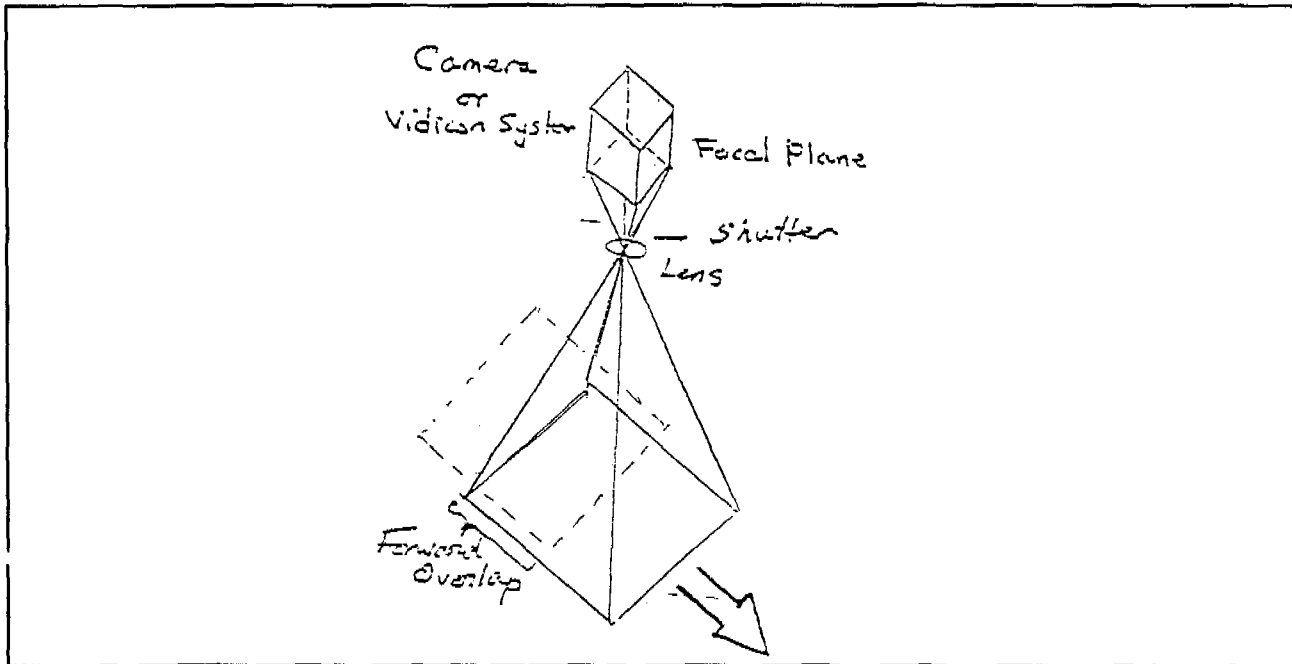
Successive frames on camera and vidicon images may be acquired with forward overlap (shown in figure VIII). The overlapping portion may be viewed with a stereoscope to produce a three-dimensional view. Film is sensitive only to portions of the ultraviolet visible and reflected infrared regions (0.3 to 0.9  $\mu\text{m}$ ). The sensitivity range of special vidicons extends into the thermal band of the infrared region. A framing system can instantaneously image a large area because the system has a dense array of detectors located at the focal plane.

## 2. Scanning systems

This system employs a single detector with a narrow field of view which sweeps across the terrain to produce an image. When photons of electromagnetic energy radiated or reflected from the terrain encounter the detector, an electrical signal is produced that varies in proportion to the number of photons. The electrical signal is amplified, recorded on magnetic tape and played back later to produce an image. All scanning systems sweep the detector's field of view across the terrain in a series of parallel scan lines.

There are four common scanning modes: (i) cross-track scanning; (ii) circular scanning; (iii) along-track scanning; and (iv) side scanning.

**Figure VIII. Framing system for acquiring remote-sensing images**



(a) *Cross-track scanning system*

This system employs a faceted mirror that is rotated by an electric motor, with the horizontal axis of rotation aligned parallel with the flight direction (see figure IX). The mirror sweeps across the terrain in a pattern of parallel scan lines oriented perpendicularly to the flight direction. Energy radiated or reflected from the ground is focused onto the detector by secondary mirrors.

The strength of the signal generated by a detector is a function of: the energy flux, altitude and spectral bandwidth of the detector; the instantaneous field of view; and the dwell time, where dwell time = scan rate per line/number of cells per line (see figure IX).

(b) *Circular scanning system*

The scan motor and mirror are mounted with a vertical axis of rotation that sweeps the terrain in a circular path (see figure IX). Only the forward portion of the sweep is recorded to produce images. An advantage of this system is that the distance between scanner and terrain is constant and all the ground resolution cells have the same dimensions. Circular scanners are used for reconnaissance purposes in helicopters and low-flying aircraft. The axis of the rotation is tilted to point forward and acquire images of the terrain well in advance of the aircraft position. The images are displayed in real time on a screen in the cockpit to guide the pilot.

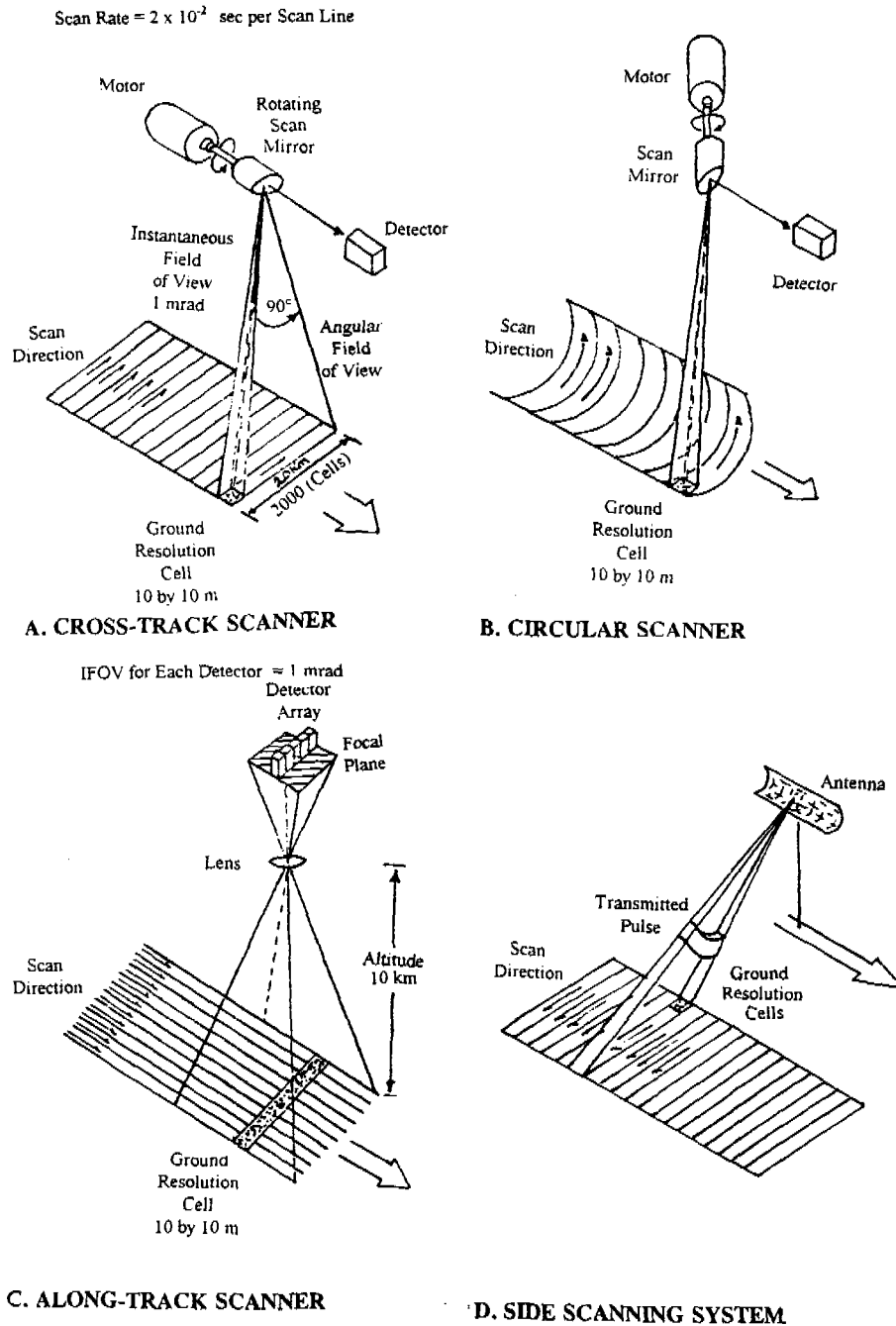
(c) *Along-track scanning system*

For scanner systems to achieve finer spatial and spectral resolution, the dwell time for each ground resolution cell must be increased. One method is to eliminate the scanning mirror and provide an individual detector for each ground resolution cell across the ground swath (see figure IX). The detectors are placed in a linear array in the focal plane of the image formed by a lens system.

(d) *Side scanning system*

This is an active system which provides its own energy sources, operating primarily in the side-scanning mode. An example (see figure IX) is a radar system that transmits pulses of microwave energy to one side of the flight path (range direction) and records the energy scattered from the terrain back to the antenna.

**Figure IX. Scanning systems for acquiring remote-sensing images**



## D. MULTISPECTRAL SYSTEMS

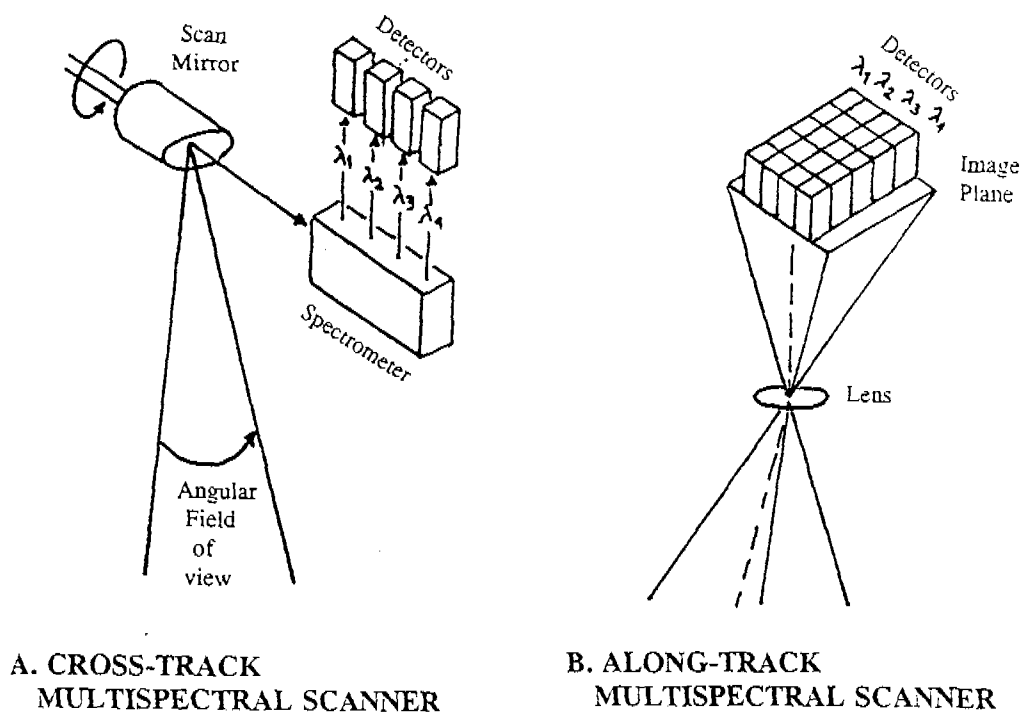
For many remote-sensing applications, it is essential to record a scene with multispectral images (multiple images acquired at different spectral bands). Multispectral cameras or vidicons may be mounted together and aligned to photograph the same area. The framing systems for multispectral imaging have two major disadvantages:

- (a) Each image is acquired with a separate lens systems, and it may be difficult to register the multiple images;
- (b) The spectral range of camera systems is restricted to the visible region and part of the reflected infrared systems.

Nowadays, all multispectral images data are acquired by scanner systems. Cross-track scanners employ a spectrometer to disperse the incoming energy into a spectrum (shown in figure X, picture A). Detectors are positioned to record specific wavelength bands of energy (denoted  $\lambda_1$ ,  $\lambda_2$ ,  $\lambda_3$  and  $\lambda_4$ ). The Landsat Thematic Mapper is a cross-track multispectral scanner that records seven bands of data: three visible bands, three reflected infrared bands, and one thermal infrared band. A typical aircraft cross-track scanner records 11 bands of data.

A long-track multispectral scanners employ multiple arrays of linear detectors with each array recording a separate band of energy (shown in figure X, picture B). Because of the extended dwell time, the detector bandwidth may be narrow and still produce an adequate signal. The spot satellite system uses a multispectral along-track scanner.

**Figure X. Multispectral scanner systems**



## REFERENCES

- Al-Naimiy, Hamid M. 1995. Remote-sensing techniques for comorative studies of watersheds in selected basins in the ESCWA region (prepared for ESCWA).
- Floyd, F. Sabins, Jr. 1986. Remote sensing: principles and interpretation.
- Rango, A. 1990. Remote sensing of water resources: accomplishments, challenges and relevance to global monitoring. International Symposium on Remote Sensing and Water Resources. The Netherlands, August 1990 (LAH/NSRSS).
- Simonett, David S. 1983. The development and principles of remote sensing (chapter 1 in Manual of R.S., edited by Robert N. Colwell, Church, Virginia).
- Japanese Association on Remote Sensing (JARS). 1993. Remote-sensing note. Tokyo.
- Royal Jordanian Geographic Centre. 1989. Canada-Jordan Remote Sensing Project. Training Manual. Amman.

## VI. BASIC PRINCIPLES OF REMOTE-SENSING

*by*

*Omar Malkawi\**

### A. CONCEPTS

Remote-sensing techniques and their applications in different scientific fields require an understanding of the following principles:

- (a) The concept of remote-sensing;
- (b) The relationship between energy and the remotely sensed data;
- (c) Principles of satellite imagery;
- (d) Principles of visual interpretation;
- (e) Digital analysis and its integration;
- (f) Project planning and risk management.

This lecture will focus on discussing the basic concept of remote-sensing that is needed to extract the best knowledge from remotely sensed data. It is important at this initial stage to understand the driving force which is the energy source that allow the remote-sensing technique to be of practical values in different fields. The basic element of remote-sensing represents the investigation of energy sources, the type and character of sensors and target, and images.

### B. ENERGY SOURCES

Remote-sensing involves the investigation of energy, its characteristics, and its organization and interaction. For any investigation to be of practical value, it must yield information concerning the nature and properties of a target on the earth's surface.

Remote-sensing satellites orbit the earth at a variety of altitudes, from low polar (200 km) to high equatorial (36,000 km), and their sensors gather electromagnetic energy reflected, emitted or back-scattered from part of the earth-atmosphere system below the satellite.

The most convenient and cheapest source of energy around is the sun. However, the sun's energy is not evenly distributed by wavelength. In fact, the amount of solar energy reaches a peak in the wavelength range 0.4 to 0.7 micrometres, the visible wavelengths representing part of the energy spectrum in which our eyes function best.

The amount of solar energy around certain wavelengths will tell sensor designers if there is enough energy available for a passive sensor to function or if an active sensor will be required (one which provides its own energy source). Visible, near-infrared and thermal infrared sensors can usually make due with available solar energy to illuminate the scene. The situation becomes worse in the microwave region.

Although the distribution of energy from the sun is very important, it is not the only factor to consider; above the earth there is a protective atmosphere. The atmosphere changes the distribution of solar energy

---

\* The author is a researcher at the Royal Jordanian Geographic Centre and the ESCWA project coordinator.

before it reaches earth. The effect is that at certain wavelengths very little of the sun's energy reaches the earth's surface, while elsewhere, the effect is minor.

### C. SENSORS

The effect of atmospheric absorption and reflection is particularly critical since energy is not only modified between source and target but again from target to sensor. Thus, only certain parts of the total spectrum are available for remote-sensing. These are termed the "atmospheric windows". Much of the effort in sensor design and remote-sensing program development is strongly influenced by this limitation.

The design of sensors to detect resources of energy as well as their manipulation is influenced by atmospheric conditions. The basic concepts also involve a knowledge of the sensors to be used in the remote-sensing of data. The basic electro-optical scanner sensor consists of: scanning optics, focusing optics, a beam-splitter, detectors, an amplifier and an A/D converter, as well as a transmitter and a ground-receiving station.

Different sensors can be mounted on satellite or aircraft systems. Sensors on board may vary in many respects, however; the most significant differences include:

- (a) Number of spectral bands;
- (b) Spectral bandwidth and centre wavelength;
- (c) Number of detectors per bank;
- (d) Spatial resolution(s);
- (e) Off-nadir viewing flexibility;
- (f) On-board recording;
- (g) Local ground station read-out capability;
- (h) On-board processing capabilities.

Sensor parameters, in combination with the platform and orbit characteristics, determine the overall mission capabilities and options available for data acquisition.

### D. TARGETS

Remote-sensing also involves the understanding of target characteristics and their types. Targets can come in all shapes, sizes and colours. Targets can be identified in terms of geometric properties; type (of points, lines or areas), and shape. Targets can also be identified in terms of radiometric characteristics (spectral signature). Targets are to be remotely sensed by sensors installed on the satellites.

Energy which falls on a target can be reflected at the target surface, transmitted without change through the target, or absorbed and stored within the body of the target. In reality, the response of targets is a complex combination of the above.

### E. SPECTRUM

Target surfaces can be categorized in terms of their spectral response. Not surprisingly, targets which respond similarly have similar physical or chemical properties with regard to vegetation and soil.

Targets can be identified and separated spectrally only when there is sufficient spectral contrast between the target and its background. Background contrast is significant for detecting targets.

The energy spectrum (with respect to its utilization in the sensing of data) is represented in electromagnetic wavelengths. The energy penetrating the atmosphere and reaching the earth's surface interacts with that which is presented on the ground. In the atmosphere, some of the energy is scattered, reflected and absorbed. Different process occur. When the energy reaches either the land or the water, it can also be reflected, diffused, absorbed or transmitted. The magnitude of reflection depends on terrain slope and elevation, condition, soil moisture, soil type and vegetation cover. Some of these factors change with time and season. This reflection of energy, representing a major factor in remote-sensing, depends on the characteristics of the target to be remotely sensed.

#### F. TARGET RESPONSE

The energy spectrum detected by the sensors installed in a satellite system leads to the formation of images. These images may provide information on conditions (atmosphere, vegetation soil, overburden on bedrock and so on). However, the interference between target and sensor with regard to spectral response of the terrain is influenced by the space of layers between them. The greater the number of layers between target and sensor, the lower the overall spectral response recorded by the sensor. The nature and severity of the effect on the detection of targets is dependent on the physical characteristics of the intervening layers.

#### G. IMAGES

The other basic principle of remote-sensing is the understanding of the configuration and characteristics of the satellites orbiting the earth, especially their resolution. The major satellites that are of importance to natural resources studies are Landsat, SPOT and NOAA.



## VII. GEOGRAPHICAL INFORMATION SYSTEMS

by

*Muneer Qudaisat\**

The present paper offers an overview of geographical information system (GIS) concepts and a demonstration of its capabilities rather than comprehensive information about each aspect of such systems; it is addressed to those users who may have had no previous experience with GIS software. The applications discussed here deal specifically with geological, hydrological and hydrogeological information.

### A. WHAT IS A GIS?

A GIS is a collection of software, hardware, geographic data and qualified personnel designed to effectively capture, store, update, manipulate, analyse and represent spatially referenced data for solving complex planning and management problems.

A GIS, like the water cycle in nature, starts and ends in the real world. To begin with, information which corresponds to certain phenomena is collected from books, maps and/or other sources and stored in a database. Once information has been stored it can be updated if necessary, and it can be manipulated and analysed to produce new information. Once the results meet the requirements of a particular situation, the information can be displayed on a computer screen or printed on paper in the form of reports, statistics or maps, then presented to decision makers so that actions can be taken in the real world. Essentially, the GIS is a tool which can be used to provide detailed factual information so that more informed decisions can be made.

### B. INFORMATION PROCESSING IN A GIS

Four types of data can be manipulated by a GIS: geographical locations, time, descriptions and spatial relationships.

Geographical location is represented by its coordinates, which may be geographic ( $\phi$ ,  $\lambda$ ,  $Z$ ) or cartographic ( $x$ ,  $y$ ,  $z$ ). Time is a very important factor in GIS; for example, land which is used for cereals this year may be used for vegetables next year. With a GIS, geographical features can be described; in other words, in addition to indicating where a road is located, a GIS can provide information on the length, width, and type of road it is this information may be stored in a GIS as an alphanumeric attribute. Finally, GIS makes it possible to spatially relate geographical features using topological relations such as inclusion, intersection, neighbourhood and superposition.

The information provided by a GIS answers the questions: Where is it?, When did it occur?, What is it? and How is it related to the other features?

### C. DATA REPRESENTATION MODELS

Two models have evolved for storing locational information in digital form: the raster model and the vector model.

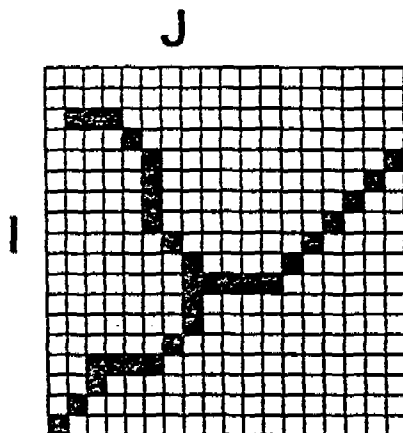
---

\* The author is a GIS researcher at the Royal Jordanian Geographic Centre.

### 1. *The raster model*

In the raster model, a geographic area is divided into equal rectangular or square cells which constitute a matrix. Each cell is the intersection between a column and a row in the matrix and is known by the number of the line and the row (such as I and J in figure I below). Each cell is called a "pixel", a short form of "picture element".

**Figure I. The raster model matrix**



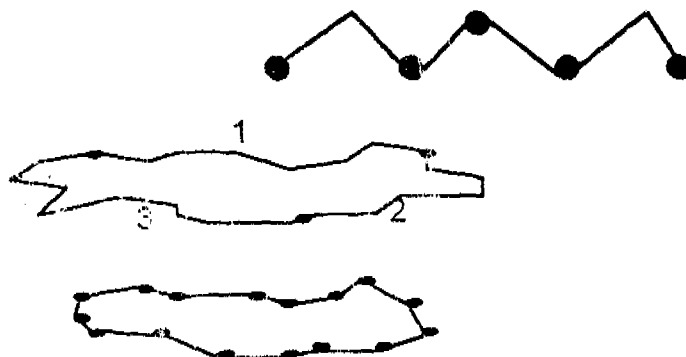
This model is used mostly with digital images, so the clarity of the image depends on the resolution of its pixels. Digital images may be obtained by scanning analogue photos or maps, or directly from observation satellites. The unit in this model does not represent a geographic feature, so, many pixels are needed to represent a road, a field or any other specific feature. The model is not very compact; it requires a large amount of computer memory. However, potential problems can be avoided through the use of one or more of a wide variety of compacting techniques such as Run-length coding or Quad-tree.

### 2. *The vector model*

In the vector model, geographical features are represented by point, line and surface (see figure II):

- (a) The point is defined by its  $x, y$  coordinates;
- (b) The line is defined by a series of  $x, y$  point locations;
- (c) The surface is defined either by a series of lines or by a closed series of  $x, y$  point locations.

**Figure II. Representation of geographical features in the vector model**



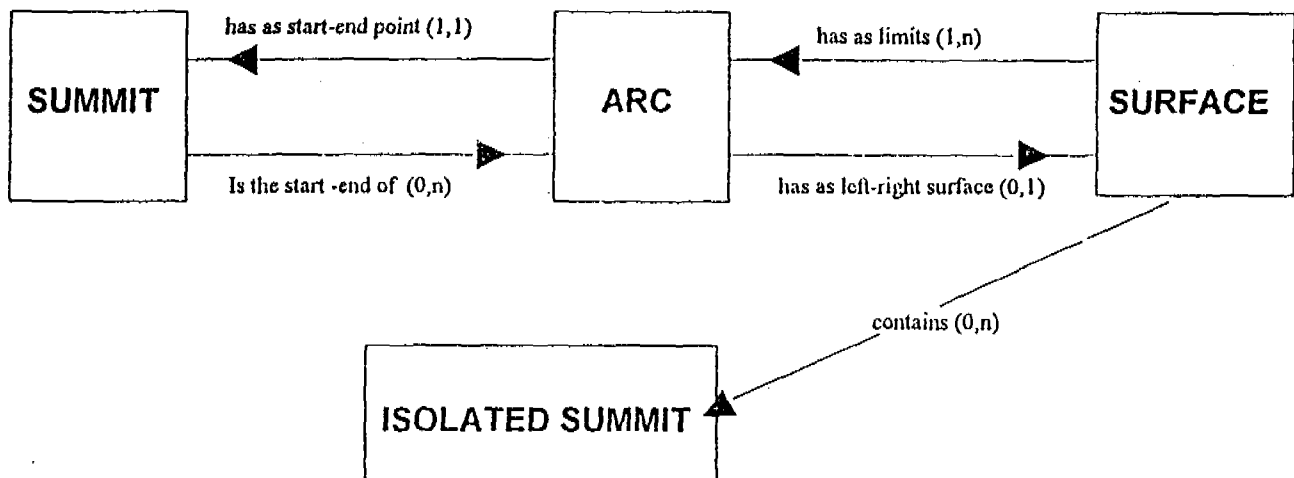
This model is more compact than the raster model, as each unit represents a geographical feature.

The vector model includes two types: the spaghetti model and the topological model.

In the spaghetti model, data are processed without any proper structure, and the absence of spatial relationships means that each feature exists independently, with the result that data are duplicated and file sizes are increased. This kind of model is used mostly in computer-aided design (CAD) systems.

In the topological model, data are processed within a relational context; attention is paid to inclusion, intersection, neighbourhood and superposition (see figure III). This method of representation reduces file sizes because there are no duplicated data. The topology is provided in a relational manner which makes it possible to avoid the use of coordination in a very large number of analytical operations.

**Figure III. Data collection in the vector model's topological model**



### 3. Vectorization

Vectorization refers to the process of converting raster data into vectors. Fully automatic vectorization has not been possible owing to a variety of factors, including the quality, legibility and reliability of source documents. The process may be carried out in a semi-automatic manner, however; in fact, the operator can digitize over a raster line on the screen. In this interactive process, the raster data is displayed on a background layer on a graphic screen while the operator digitizes vectors on another layer.

#### D. DATA ENTRY

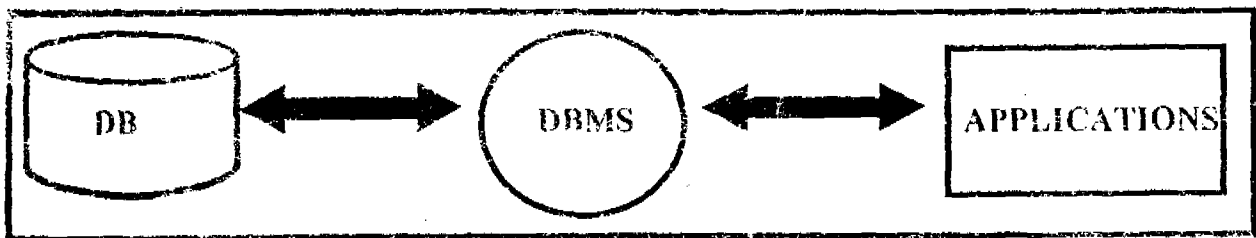
Data entry refers to the process of storing data in the computer using input hardware. Alphanumeric descriptive data are entered mainly through a keyboard. Graphic data may be entered using a variety of instruments, including digitizing tables, photogrammetric devices, and field survey instruments, for recording vector data and a scanner and satellites for recording digital images. Other sources of data may be used in a multimedia environment, including photos of features, voice and video.

## E. DATA STORAGE

Data are entered into a database, which is a collection of information about entities and the relationships between them. Graphic and alphanumeric data may be collected in a single database, two separate databases, or a database for alphanumeric information and files for graphic information.

The database is managed by a database management system (DBMS), which is a collection of software allowing for the manipulation and updating of data. DBMS can also act as an intermediate processor between the database and the applications built around it, so the applications do not have to take into account the physical structure in which data are stored (see figure IV). The DBMS exists as a control centre for the database and plays a major role in ensuring quality in terms of selective access, integrity and data sharing.

Figure IV. The flow of data in a database management system (DBMS)



Four data models are used for structuring the information in the database, namely the hierarchical model, the network model, the relational model, and the object model. Most suitable for geographic data storage is the object model, which incorporates the elements of class, object, attribute and heritage.

## F. SPATIAL ANALYSIS

Spatial analysis can be defined as an analytical technique associated with the study of the location and spatial dimensions of geographical entities; it is also referred to as quantitative analysis. Spatial analysis is the most important characteristic differentiating GIS from CAD systems. It incorporates the following functions.

(a) *Research*: finding objects which meet certain conditions, so a search can be carried out for an object inside a polygon, objects intersecting a line and so on;

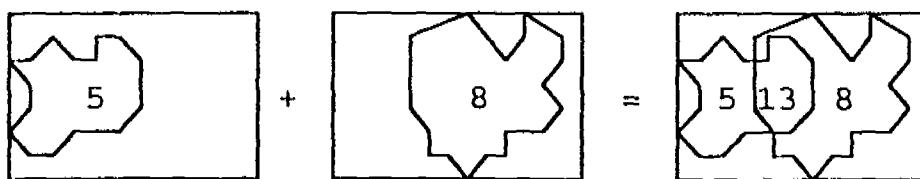
(b) *Classification*: identifying objects as belonging to a certain category (for example, the classification of lands as agricultural, industrial, or deserts);

(c) *Measure*: calculating the length of lines (roads), the surface area of polygons (fields) and the distance between two points (cities);

(d) *Overlay*: incorporating the use of the four algebraic operations (addition, subtraction, multiplication and division); it is mostly used in the raster model. For example, given two layers of soil types and agriculture types, a determination can be made about which soil is most suitable for a certain type of agriculture. Figure V shows an example of an overlay using the addition operation.

(e) *Neighbourhood*: identifying the surface surrounding a certain feature. The following three factors have to be known: the location of the feature, the characteristics of the neighbourhood (distance, time) and the neighbourhood specifications (number, mean, extreme and so on).

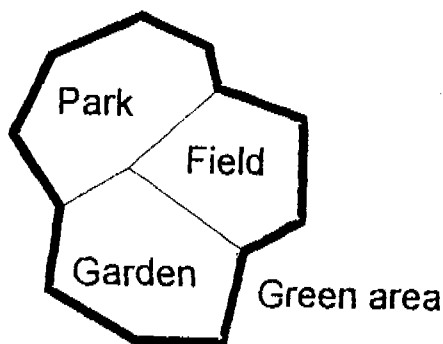
**Figure V. A raster model overlay using the addition operation**



(f) *Connectivity*: determining the relationship between connected features by answering three questions: How are the features connected?, What are the conditions of and constraints on movement?, and What is the unit of measurement? In this function, features are connected in an arc-node topology forming a network. Several aspects of connectivity are described below:

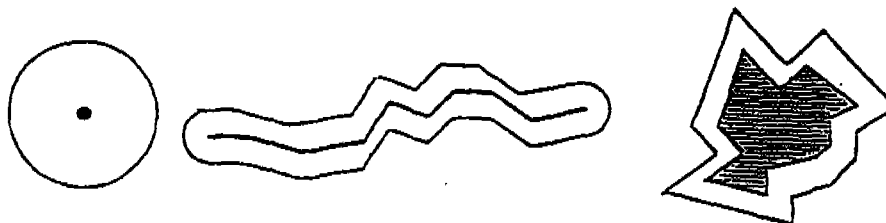
- (i) Contiguity relates to surfaces sharing common characteristics, as shown in figure VI;

**Figure VI. Contiguity in a topological model**



- (ii) Proximity is used to describe surfaces which surround certain phenomena, as shown in figure VII;

**Figure VII. Proximity in a topological model**

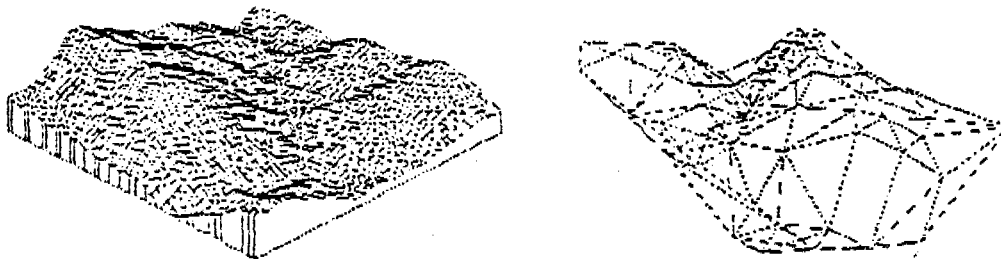


- (iii) The network aspect of connectivity deals with the movement of resources, so, what is being transported, the place of departure, the place of arrival, and the conditions of and constraints on movement must all be known. The network is also used in calculating the shortest path between two points;
- (iv) Propagation is determined by using time and distance to estimate the volume of phenomena such as liquids and smoke;
- (v) Run-off and intervisibility both depend on the Digital Terrain Model (DTM) described below.

## 6. THE DIGITAL TERRAIN MODEL

The DTM provides a digital representation of relief in two different ways. In the first type of representation, the geographical area is divided into square, adjacent cells, the intersections are given calculated heights, and the resulting grid is projected in perspective. The second method involves finding the altitudes for a set of points and connecting them in an irregular, triangular manner respecting the Delaunay criterion, then projecting the resulting network (see figure VIII).

**Figure VIII. The Digital Terrain Model**



The DTM is most commonly used for the following:

- (a) The extraction of contour information;
- (b) The calculation of map slope;
- (c) The extraction of drainage network information;
- (d) The geometrical correction of digital images;
- (e) Generating perspective views;
- (f) Measuring the slopes of geological structures;
- (g) The extraction of geological profiles;
- (h) The estimation of water volume in dams;
- (i) Identifying the best trajectory for a new road or other feature.

## H. DATA REPRESENTATION

Once the map has been constructed it can be displayed on a computer screen, copies can be made on screen or on paper using plotters or normal printers, and/or the map can be transmitted elsewhere via computer fax.

## I. THE POTENTIAL BENEFITS OF GIS

The quantitative benefits of GIS include the following:

- (a) Productivity is increased because a huge amount of information can be manipulated rapidly;
- (b) Data can be updated and/or exchanged with others in a timely manner;
- (c) Central databases provide easy access to a comprehensive selection of data;
- (d) Reports and statistics can be readily produced;
- (e) Engineering and planning projects can rely on the GIS as a source of information and support.

The following are among the most important qualitative benefits of GIS:

- (a) Inquiries can be answered more accurately and rapidly;
- (b) Accurate central databases ensure that the analyses and final outputs are of the highest quality;
- (c) Maps can be produced at any scale desired;
- (d) Information storage requirements are reduced.

## VIII. THE CONCEPT OF DATA INTEGRATION (RS, GIS, AND RELATED FIELD DATA)

by

*Omer Al-Qudah\**

### Introduction

Data integration refers to the process of combining remote-sensing data (bands) and other sources of data to produce new, enhanced images useful for feature extraction.

Remote-sensing images are provided in the form of bands, and each band is considered a source of data, as reflectance, absorption and diffraction differ along the length of the spectrum and from one band to another. Other sources of data come in the form of maps which illustrate such features as magnetic fields, and geological and geochemical attributes.

In remote-sensing, data can be integrated through the use of the following:

- (a) Band combinations (colour composites);
- (b) Colour display transformations;
- (c) Arithmetic and logical combinations;
- (d) Principal components.

#### A. BAND COMBINATIONS

Bands can be combined to produce colour composite images. These images are generated by composing three selected multi-band images through the application of the three primary colours. Different colour images may be obtained depending on the selection of the three band images and the assignment of the three primary colours.

There are two types of colour composites: additive and subtractive. An additive colour composite includes the three light sources of the three primary colours (blue, green and red) and is used in a multispectral viewer or colour graphics display. A subtractive colour composite incorporates the three pigments of the three primary colours (cyan, magenta and yellow) and requires the use of a colour printing device.

When the three colour filters B, G and R are assigned to the same spectral regions of blue, green and red, it is possible to produce almost the same colours as the natural scale; the resulting image is called a true-colour composite.

In remote-sensing, multi-band images are not always divided into the same spectral regions as the three primary colour filters. In addition, images with invisible regions such as infrared often need to be displayed in colour. A colour composite with an infrared band is called a false-colour composite. The following are examples of some of the most useful Landsat - Thematic Mapper (TM) band combinations in a red-green-blue (RGB) display monitor (additional examples are provided in the section on arithmetic combinations:

---

\* The author is a remote-sensing researcher at the Royal Jordanian Geographic Centre.



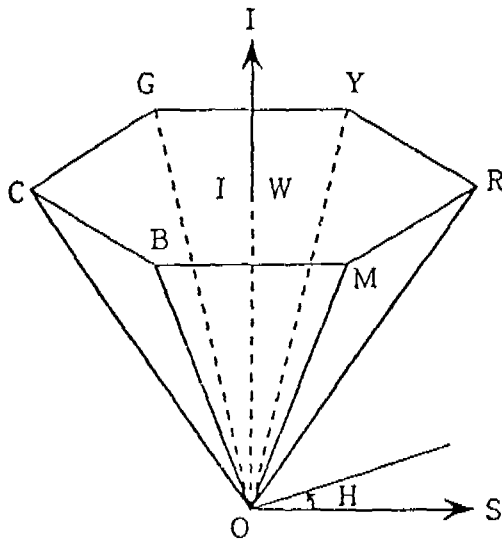
- (a) TM3, TM2 and TM1 for true colour composition;
- (b) TM4, TM3 and TM2 for vegetation;
- (c) TM7, TM5 and TM1 for geological features.

It should be noted that colour composites may be assigned to the subdivided grey scale of a single image. Such colour allocation results in what is called a pseudo-colour composite; for example, a pseudo-colour of a thermal infrared (TM6) image constitutes a temperature map.

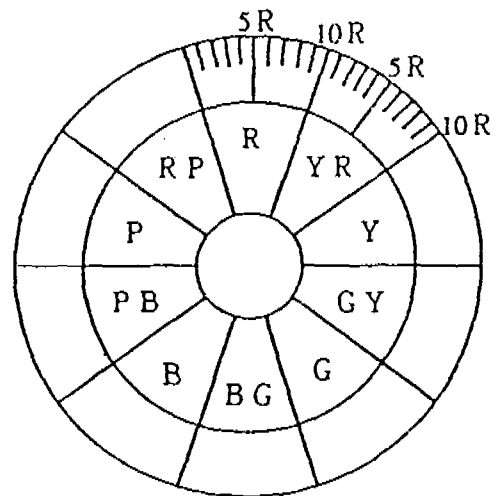
### B. COLOUR DISPLAY TRANSFORMATIONS

Colour display transformations involve the conversion of RGB into intensity, hue and saturation (IHS) following the Munsell colour system, in which colour is represented by IHS as a psychological response (see figure I). Hue is based on 72 incremental differentiations between five basic colours: red (R), yellow (Y), green (G), blue (B) and purple (P), which are located around a hue ring. Intermediate colours are located between the five basic colours and are designated by the letters YR, GY, BG, PB, and RP. Finally, each hue is divided into 10 parts—for example 1R, 5R, 10R, 1YR, 5YR, and 10YR (see figure II). Intensity is an index of brightness which includes 11 levels, from 0 (dark) to 10 (light). Saturation is an index of purity which ranges from 0 to 16 depending on the hue and intensity. Colour in the Munsell colour system is identified as a combination of hue and intensity/saturation; for example, 5R4/10 refers to a hue of 5R, an intensity level of 4 and a saturation level of 10. Munsell colour samples are available in the commercial market, and mathematical formulas for conversion between RGB and IHS can be found in books on digital image processing.

**Figure I. Relationship between RGB space and IHS space**



**Figure II. Three-dimensional colour solid (Munsell's solid)**



The colour display transforming technique is very useful in remote-sensing, as illustrated in figures III, IV and V.

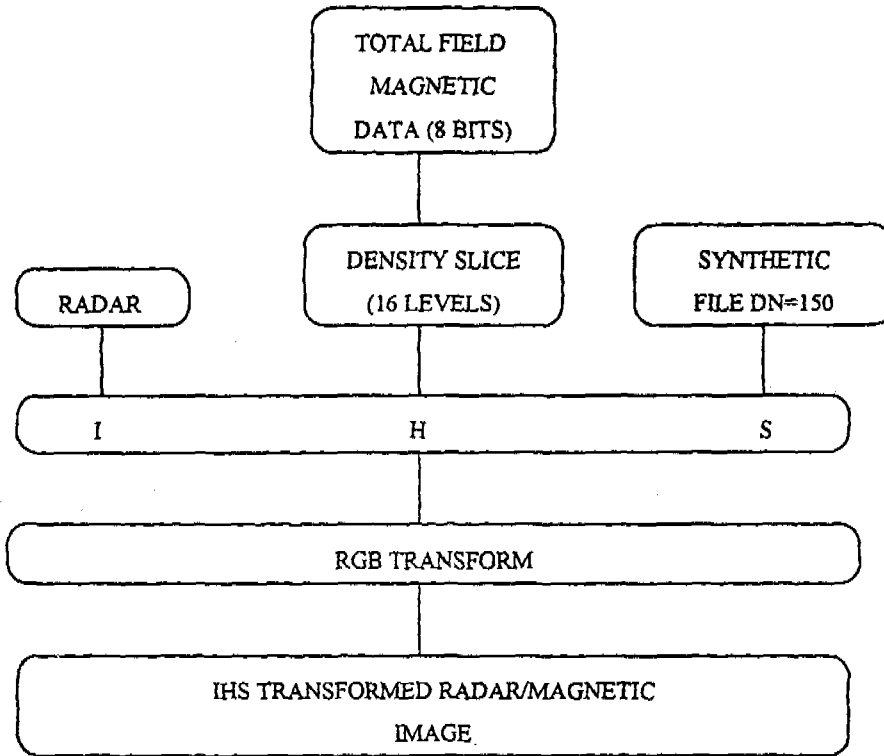
### C. ARITHMETIC AND LOGICAL COMBINATIONS

Employing arithmetic and logical combinations in dealing with multi-spectral images or multi-temporal images is very useful for different types of applications such as extracting geological features, detecting changes in land use, monitoring vegetation cover, and enhancing images through the elimination of noise.

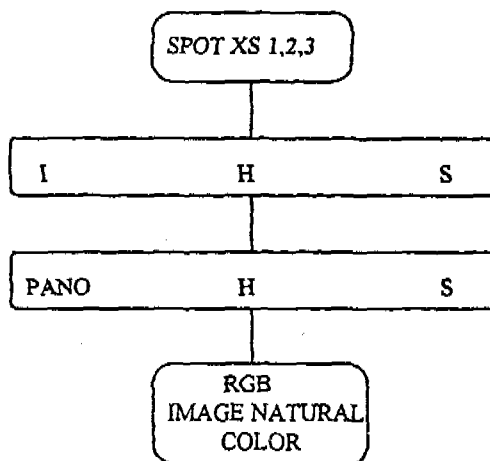
1. *Arithmetic combinations*

Addition, subtraction, multiplication, division and their combinations can be used for many purposes. As an example, green vegetation has a high, near-infrared reflectance and a low red reflectance, while bare surfaces do not show such sharp distinctions; a subtraction of red from near infrared or the normalized subtraction gives high values for healthy green vegetation and low values for bare surfaces.

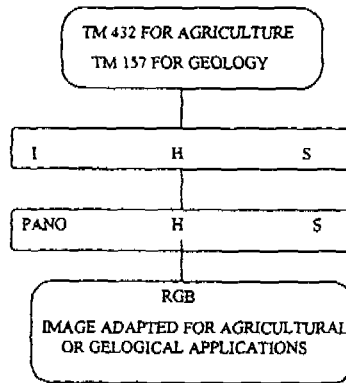
**Figure III. Colour display transformation of a radar/magnetic image**



**Figure IV. Colour display transformation of a SPOT (P+XS) image, natural colour**



**Figure V. Colour display transformation: TM imagery integrated with SPOT-PANO for agricultural or geological applications**



The most commonly used arithmetic operations are as follows:

- (a) Vegetation index =  $TM4 - TM3$
- (b) Normalized vegetation index (NVI) =  $\frac{TM4 - TM3}{TM4 + TM3}$
- (c) Iron oxide =  $\frac{TM3}{TM1}$
- (d) Clay minerals =  $\frac{TM5}{TM7}$
- (e) Ferrous minerals =  $\frac{TM5}{TM4}$
- (f) Mineral composite (RGB) =  $\frac{TM5}{TM7}, \frac{TM5}{TM4}, \frac{TM3}{TM1}$
- (g) Hydro thermal composite (RGB) =  $\frac{TM5}{TM7}, \frac{TM3}{TM1}, \frac{TM4}{TM3}$

## 2. Logical combinations

Logical addition (or), logical multiplication (and), logical comparison (true-false operations) and so on can be applied in dealing with multi-temporal images or a combination of remote-sensing images and thematic map images. For example, laying a remote-sensing image over the mask of a forest land thematic map produced by an old image is very useful for detecting changes in land use.

## D. PRINCIPAL COMPONENTS

Arithmetic and logical combinations concentrate on two wave bands. A large number of bands can be combined through the use of principal component analysis, which involves finding a new set of mathematical variables that describe the variance in the original data set but which are independent of each other. The correlation between the new variables should be zero. These new variables or principal components are mathematical combinations of the original wave bands. The first principal component

The first principal component normally shows albedo or brightness for visible and near infrared bands, and the second principal component often shows an indication of greenness. The first three principal components generally contain more than 90% of the features; however, one of the other principal components may contain information not existing in the first three.

As the principal components are independent of each other, a colour combination of the first three components can be useful in providing maximum visual reparability of image features. These first three components can be displayed separately in red, green and blue. This often produces a better colour image than the use of the original wave bands.

## **IX. HYDROGEOLOGICAL MAPS USING GIS (ARC/INFO)**

*by*

*Ghazi Qussous\**

### **Introduction**

Rapid developments in computer science and telecommunications have made it possible to apply these fields in map-making. In fact, map production has been revolutionized, and the traditional manual methods have given way to a fully computerized approach. The introduction of computers in map-making started with analytical stereoplotters in the field of photogrammetry. The introduction of digitizing equipment then helped to transform paper map information to digital data, leading to the creation of digital map libraries. Digital mapping was introduced with the development of the appropriate software and hardware, including the geographical information system (GIS), which has enhanced the advancement of mapping technologies. GIS has become a major tool in planning and decision-making at all levels.

#### **A. WHY GIS?**

The declining cost of computer hardware and the realization that geography and the data describing it are part of everyday life made GIS very important in decision-making and planning. In fact, almost every decision made is connected with some aspect of geography: ambulances are sent to the scenes of accidents by the fastest available routes; educational planning and school placement decisions are, to some extent, based on location-related factors; and forest fires and the way in which they spread can be simulated and monitored through the modelling of geographic data. GIS technology provides a means of integrating information in a way that helps people in various fields to understand and address some of the most pressing problems faced today; in particular, it provides a better understanding of the spatial relationships connected with the different problems as a basis for more sensitive and intelligent decision-making.

#### **B. WHAT IS A GIS?**

A GIS is an organized collection of computer hardware, software, geographic data and trained personnel designed to efficiently capture, store, update, manipulate, analyse, and display all forms of geographically referenced information.

A GIS exists essentially to process geographic information using computers. Such information must be acquired and processed so that digital databases can be established as a general archive for future needs or for specific applications.

#### **C. INTRODUCTION TO ARC/INFO**

Arc/Info is a type of GIS software used to automate, manipulate, analyse and display geographic data in digital form. It is characterized by: its data model; the GIS functions it performs; its tabular design; its ability to integrate many types of data; its utility for developing application-specific user interfaces with screen menus; its fourth-generation macro language (AML); and by its open architecture which allows for the integration of numerous relational database management systems. The software allows locational data

---

\* The author is a GIS researcher at the Royal Jordanian Geographic Centre.

to be transformed into simple structures through the use of coordinates and topology. The cartographic x, y coordinate data are used to identify arc, node and polygon relationships, and the creation of topological files is fully automatic.

### 1. Overview of Arc/Info

#### (a) System design

Arc/Info is designed such that logical groups of functions are organized within individual modules; for example, all cartographic editing functions are grouped in one module, and all of the map output and drawing functions are grouped into another. Thus, Arc/Info contains a number of subsystems or programmes, each with its own set of commands and logical functions.

The activity of Arc/Info to perform general GIS functions can be described with reference to four broad categories, namely input, analysis, data management, and display and conversion.

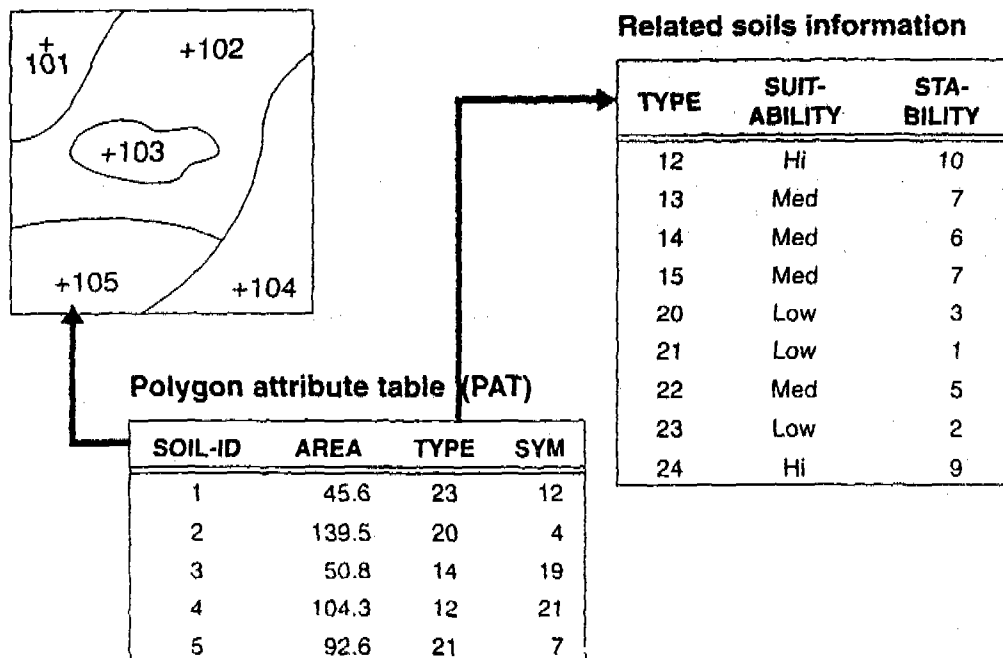
#### (i) Structure and logical data model

##### a. Arc/Info structure

Arc/Info is a cartographic system built around a hybrid data model. It organizes geographic data using a relational and topological model. The topological structure created by Arc/Info has four very important advantages:

- i. Polygon boundaries are efficiently stored;
- ii. The arc-node data structure increases the speed of data retrieval and processing;
- iii. Certain types of spatial analysis can be performed;
- iv. It allows for the storage of very large, continuous map "coverages".

Figure I. Arc/Info structure: data matching

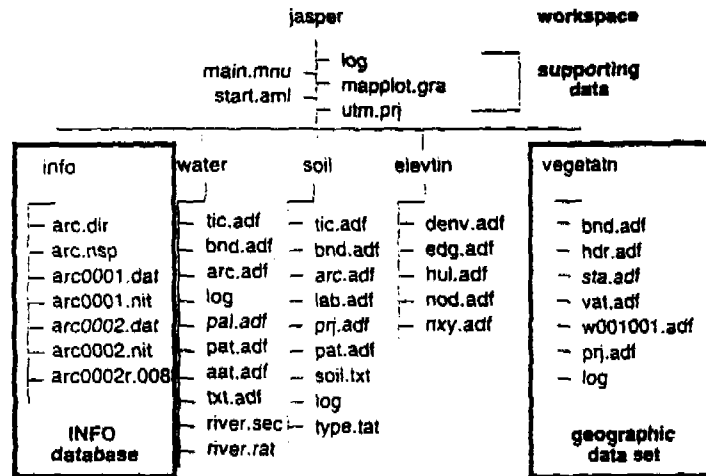


For descriptive data, a fully relational database management system (DBMS) allows for the easy creation and management of georeferenced tables of statistical and thematic data, including numerical and textual data. Arc/Info supports the simultaneous reading and relational matching of data from a number of feature attribute files (see figure I).

b. Arc/Info logical data model

Arc/Info explicitly represents all map features by sets of arcs and label points and as topological relationships between connected lines and points (see figure II).

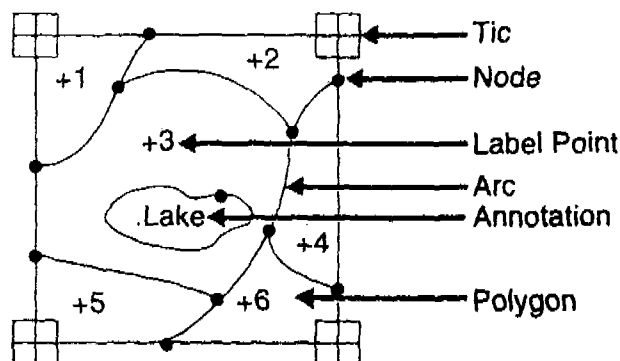
**Figure II. Arc/Info logical data model**



A coverage is the basic unit of storage in the Arc/Info data model. It is a digital version of a single map sheet layer and generally describes only one type of map feature such as roads, vegetation or soils. A coverage contains both locational data and thematic attributes for map features in a given area. The locational data may be represented explicitly (as a series of x, y coordinates) or topologically (as a combination of features).

In a coverage, several features may be present. There are four types of primary coverage features used to represent points, lines and areas on a map: arcs, nodes, label points and polygons. Secondary features, while still important, help to convey more general information about a coverage and are used for registering coverage, defining the map extent, creating annotation maps of the coverage, and performing coverage adjustments. Secondary features include tics, coverage extent, annotation and links (see figure III).

**Figure III. Some of the common feature classes in a coverage**



## D. THE DEVELOPMENT OF HYDROGEOLOGICAL MAPS

### 1. Overview of the ESCWA project

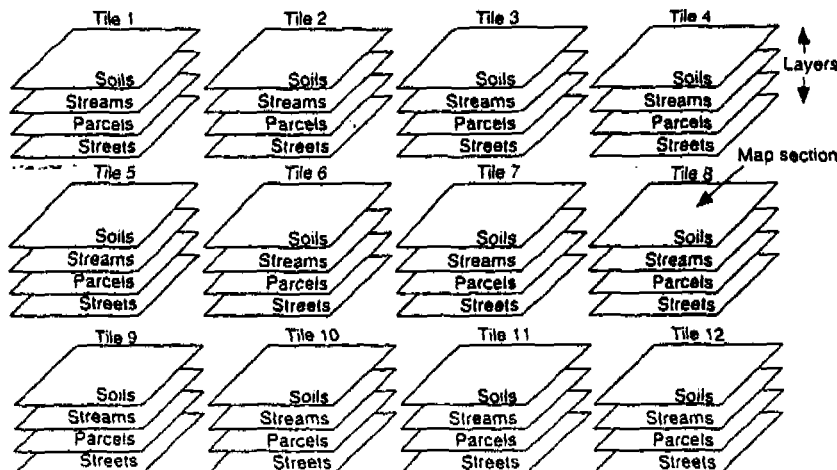
The data for the project on water resources assessment in the ESCWA region using remote-sensing and GIS techniques was processed by the (GIS) Digital Mapping Unit at the Royal Jordanian Geographic Centre (RJGC) at the beginning of January 1995. The Centre formulated a project plan and selected a project team. The plan consisted of the major tasks described below:

- (a) Preparing map and document databases;
- (b) Procuring and evaluating the Digital Chart of the World (DCW), which was procured for the project;
- (c) Dividing the project area into zones and identifying the projection to be used;
- (d) Using the above-mentioned digital data in combining the necessary coverages and layers and preparing all of the basic maps necessary for the project;
- (e) Defining all of the layers to be transferred to the remote-sensing unit related to the updating of the hydrological network and identifying the raster image data to be transferred back to the GIS to update the base hydrogeological maps for the preparation of the final output;
- (f) Preparing the special symbols for the hydrogeological map sheets;
- (g) Plotting the draft and final project maps.

### 2. Project execution

*Step one.* As mentioned above, the first task was to procure the ONC paper maps on the scale 1:1,000,000 and the digital data covering the entire project area using a copy of the DCW acquired for this purpose. The needed features for the whole area were extracted from the appropriate tiles (see figure IV).

**Figure IV. A map library, organized with coverage spatially by tiles and thematically by layer**

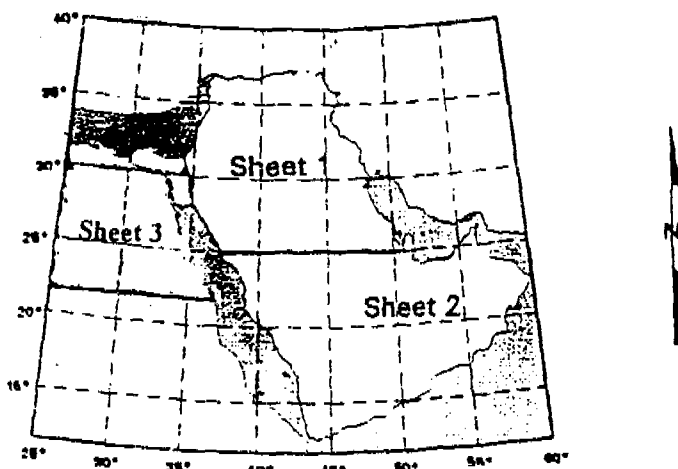




The following procedures were used:

- (a) All coverages of the same feature class (hydrographic networks, roads, miscellaneous lines and so on) were combined to form one coverage of the whole area;
- (b) The project area was divided in three major zones; Egypt was in one zone, and the rest of the ESCWA region was divided into northern and southern zones. The separation was at 25° latitude (see figure V);

**Figure V. The three major zones for the ESCWA hydrogeological map project**



*The boundaries and names shown and the designations used on this map do not imply official endorsement or acceptance by the United Nations.*

(c) A database was set up, and a topology was created. Owing to the fact that the combined coverages for each zone required the use of massive amounts of computer memory and that the southern zone (zone 2) had a large number of small polygons, and in the light of certain limitations in Arc/Info (for example, a polygon could not have more than 5,000 arcs), the team was obliged to subdivide the zones by adding lines with a specific code number so that new polygons were created without affecting the original data (these new arcs would be skipped in the overall processing of the data). In this way, it was possible to establish the topology for the different areas of the project;

(d) The data were plotted and checked. Each coverage was plotted using the pen plotters made available at the beginning of the project (an ink-jet printer was later installed). These map plots were checked against the original ONC paper maps, on the scale 1:1,000,000 giving the team an opportunity to confirm the suitability of the DCW for the project, examine the proposed output scales (1:2,500,000 and 1:500,000) in connection with the generalization problem, and decide on the final divisions of the three zones;

*Step two.* The second part of the project involved preparing the above-mentioned data in the raster format and transferring them to the RJGC Remote-Sensing Unit so that they could be corrected and updated using satellite imagery. Arc/Info software with the Grid module was used.

*Step three.* Output map sheets were prepared at different scales so that they could be used collectively as hydrogeological base maps.

*Step four.* Feedback from the Remote-Sensing Unit was used to correct and update the basic hydrogeological maps. For this purpose, the raster data were transferred back to Arc/Info through the network, and the images were converted to the Arc/Info Grid format. These grids were then georeferenced using the actual digital data, the Grid module and the coordinate manipulation functions of Arc/Info; a large number of control points were used for georeferencing. Finally, the grids were converted into vector data coverages.

*Step five.* The base maps were used to identify major surface-water basins. Once completed, the latter were digitized and added to the system, with the basin numbers as attributes.

*Step six.* The hydrogeological maps were edited.

Initially, there was no need to involve more than two team members and a supervisor in the project owing to the type of work being done, but after the transfer of the raster imagery to Arc/Info the number was increased, and after the hydrological map sheets had been developed, the entire team worked long hours. All of the equipment in the GIS Unit was used for this project. To summarize, the work consisted of the following:

- (a) Digitizing and scanning the hydrogeological map sheets;
- (b) Plotting and checking these sheets;
- (c) Editing the different coverages obtained;
- (d) Preparing the special hydrogeological legends and texts for all the map sheets;
- (e) Plotting the map sheets for checking by the hydrogeological specialists;
- (f) Correcting and editing all the checked map sheets;
- (g) Plotting the draft of the map sheets;
- (h) Doing final corrections, and plotting the final maps of the project.

### *3. Facts and statistics related to project execution*

Some 800 megabytes of data were being dealt with during the execution of the project. The team, which consisted of one engineer and eight technicians, spent a total of 3,900 hours on the project; every member had to work overtime during certain phases of the work—sometimes until the early morning hours.

The following hardware and software were used during the different phases:

- (a) Five digitizing stations (A0 size) and a scanner (Contex, 1,000 dpi/A0 size) were used for data entry;
- (b) One VMS (Vaxstation 3500) and five UNIX (HP and SON) processing workstations constituted the processing unit;
- (c) The output equipment consisted of two pen plotters (Benson 1645-R and 1625-SR) and one colour ink-jet (Calcomp);
- (d) Arc/Info (revision 7.03) with the Grid module was the software used.

## **X. ANALYSIS OF REMOTE-SENSING DATA THROUGH GIS SOFTWARE**

*by*

*Rafe Ashour\**

### **Introduction**

Remote-sensing and GIS techniques are applied to analyse natural phenomena that have geographic or spatial characteristics. In the past, the development of these two techniques evolved separately. Recently, however, there has been a rapid convergence of the use of both techniques in order to achieve detailed analysis of spatial phenomena for the purpose of monitoring and managing natural and cultural resources.

#### **A. DATA SOURCE**

Remote-sensing images are derived from numerous satellites and are transmitted in digital form to ground-receiving stations. The raw digitized data are translated into internationally recognized formats and made available for use on either computer tapes or floppy disks.

#### **B. GIS COMPONENTS**

The components of the GIS system include hardware to store and display information, software to control and perform operations, and human expertise to operate the system. Personal computer (PC)-based GIS hardware consists of a PC with expanded memory and disk storage, a tape drive to input and output digital data, and a digitizing table to input data from map sources. The system should include a colour graphics monitor, a plotter and a printer to produce cartographic output in analog or tabular form. The hardware may also include devices such as a digitizing camera, optical disk drive, and communications hardware.

The GIS software package usually consists of three components: graphics and attribute databases and a user interface. The graphical database has two data structure features: vector encoding and raster encoding. Quad-tree encoding is a variant of the raster structure. The raster system focuses on topology (location values) while the vector database evolved from traditional cartography, in which features can be represented as points, lines and polygons.

The main advantages of the vector system are its high resolution and precision, output flexibility, easy map manipulation, and relationship of data size to data density. Some disadvantages include the lack of spatial manipulation (topological features must be explicitly created), low tolerance for errors, and the complexity of map overlays.

The raster data system involves the encoding of digital images from Landsat or SPOT satellites. The data set is constructed from a matrix of lines and rows addressed by the coordinates. The lines which make up the boundary width are controlled by input pixels. The main advantages of this system include its ability to manipulate spatial features and to handle simple area calculations and simple multi-layer overlays, as well as its efficiency in capturing large volumes of data. The disadvantages include non-traditional cartographic display and limitations in cell size.

---

\* The author is the Director of the Production Department of the Royal Jordanian Geographic Centre.

Another form of data encoding is represented by the quad-tree system. This encoding system is usually used to reduce storage redundancy and overcome inefficiencies in the raster system. In the quad-tree system, the region is divided into smaller and smaller quadrants. The subdivision of quadrants ceases once a square becomes homogeneous. Detail is presented only when it exists in the data.

The attribute database allows for the storage, manipulation and reporting of characteristics that have been identified by the user as significant. There are three types of attributes within the database: hierarchical, network and relational.

Hierarchical attributes are represented by a tree-like structure which is formed during a level-by-level search sequence (for example, postal code and soil classifications).

The network database represents an extension of the hierarchical type and requires extensive prior knowledge of the data being organized. The database is recognized by record type, which is defined and maintained throughout the data set.

The database is searched for through one of many possible network paths.

The relational data set allows the user to relate numerous data tables through common features. Prior to the merger of the tables, the user may have access to one or all data sets. This feature is significant with regard to information from different map levels, where different attributes can be manipulated and analysed without having to append all data to a common table.

### C. DATABASE ASSESSMENT

Data sets usually vary in their characteristics. Each data set must be evaluated in terms of its history, reliability and compatibility with other data sets in the database. Assessing databases requires the consistent evaluation of their characteristics with regard to data: format, scale, resolution, accuracy and precision. The compatibility of data formats makes it easier to capture and integrate data. Earth resources data have traditionally been collected as point samples and presented in tabular or graphic formats.

Most of the difficulties and high costs associated with the use of GIS technology emanate from format conversion. Format compatibility is important in the planning phase, prior to database construction, especially when dealing with data from different sources. In the past, most earth resources data sets were archived and supplied in analog form. However, with the advances in GIS technology, analog data sets can now be digitized and supplied as computer media.

The integration of such data sets requires detailed knowledge of the data history. Remotely sensed data are now available in digital form, which makes it possible to process and analyse large volumes of information.

Other database characteristics include the scale and resolution of the data set. The most common errors encountered in selecting, comparing and merging data sets relate to identifying the scale on which the data were collected and determining the degree of reliability of resolution. It is essential to determine the scale for an area (spatial), time (frequency of observation), and process (physical target) in order to minimize errors.

GIS applications emphasize the spatial accuracy of remotely sensed data and the precision of point sample data. The attributes associated with point sample data can be modelled spatially, and the results can

be compared directly with the observed spatial distribution of remotely sensed image data without contributing to decreased accuracy or increased integration problems.

#### D. GIS FUNCTIONS

The main GIS processing functions include the retrieval and display of both map and attribute data. Specific GIS functions consist of data retrieval, manipulation, map overlay and dissolve, measurement, and the establishment of buffer zones. GIS must have the capability to read in and out data, to search, to identify specific items or attributes, and to display the information in a spatial context.

Data retrieval involves searching for and capturing information from different sources. The capability to manipulate spatial data is very important in the application of GIS in different fields, especially natural resources. It is often necessary to transform the original spatial data set into geometric form, in order for it to be consistent in format with other data sets which are to be encoded. The most common data manipulations involve scale changes, distortion removal, and changes in rotation, translation and projection. The need for such transformations is common, since available data sets are rarely consistent in scale, projection, spatial accuracy, orientation, or coverage.

The GIS overlay function deals with the criterion of new map layers that result from the overlaying of one or more map layers. Attributes from input layers are combined in the overlay process. Map dissolving describes the function which allows for the deletion of boundaries between adjacent polygons having the same attribute values for a specific item. This process creates a generalized map layer with new polygons. There are many variations of the overlay and dissolve functions.

The GIS measurement function has the capability of listing and summarizing the results of all calculations in a systematic manner. Measurements may include the number of points, straight or curved line segments in a specific area, a cross-section, an area defined by a polygon, or a volume represented by a three-dimensional feature. The buffer function is used for the creation of polygons around or within points and lines, or the creation of a polygon alone. The buffering process is commonly used in planning applications such as zoning or impact assessment. An example of a point buffer is a 10-km zone created around a source of construction aggregate, representing the economic transport zone. A polygon buffer may also represent an area five minutes' walking distance from a proposed municipal park.

#### E. REMOTE-SENSING AND GIS

Remotely sensed data can contribute in a variety of ways to resource management activities involving multiple data sets. The advantages of using remotely sensed data include continuity and geometric flexibility, uniform accuracy, multi-temporal and complete coverage, and numerical data facilities for customizing image analyses. The application of GIS to remotely sensed data results in the following:

- (a) A raster image providing continuous detail through visual interpretation and comparison with other database overlay products;
- (b) Extraction of polygon data through the classification or visual interpretation of imagery;
- (c) Vector data extraction through enhancement or through the overlay of visually interpreted features.

It should be noted that full access to the information content of remotely sensed imagery may require access to specialized processing capabilities that are not included in the GIS software package.

## XI. DIGITAL IMAGE PROCESSING

by

*Samih Rawashdeh\**

### A. SATELLITE IMAGERY

Remote-sensing is the science and art of obtaining useful information about an object, area or phenomenon through the analysis and interpretation of image data, without being in contact with the area, object or phenomenon under investigation. Remote-sensing has two principle modes: (a) a passive mode; and (b) an active mode.

The passive mode depends on solar energy, but the active mode uses radar waves. This allows it to operate at night and under poor atmospheric conditions. There are two kinds of satellites: (a) satellites with high resolution, such as Spot and Landsat; and (b) satellites with low resolution, such as NOAA and Meteosat. Ground resolution is the length of the smallest area on the ground from which spectral information is received. Tables 1 and 2 show the characteristics of some satellites.

The satellite is equipped with advanced systems using high technology. These systems are called sensors. They are responsible for recording and processing the information about the object or the area under investigation. Sensors are carried by spacecraft, such as satellites, as well as by balloons and aircraft.

To demonstrate how sensors work, the multispectral scanners (MSS) for the passive mode can be chosen as an example. This is a sensor system in which an optical-mechanical system with an extremely small opening scans, by means of a rotating mirror, lines on the earth's surface. The components are split up by a dichroic mirror and a prism and are recorded by a number of detectors (see figure I). Each of these detectors is sensitive to the energy in a certain wavelength range, and the spectral resolution of the detectors is thus defined. The energy picked up by a detector continuously generates an electrical pulse of an intensity directly proportional to the amount of light received by the detector during the scan. Digital numerics (DNs) corresponding to the intensity are read from the numeric scale and registered on tape. Radar sensors are different from sensors in the passive mode (see figure II). They are composed of the following elements:

- (a) An antenna for receiving and sending waves;
- (b) A generator of impulsion;
- (c) A transmission/receiving interrupter for separating the outgoing and the incoming microwaves;
- (d) An electronic clock to measure the time between incoming and outgoing waves;
- (e) A signal-processing system;
- (f) A system to register the values of incoming radar signals on a tape recorder after they pass through the processing system.

---

\* The author is a remote-sensing researcher at the Royal Jordanian Geographic Centre.

TABLE 1. PRINCIPLES OF REMOTE-SENSING\*

Landsat					SPOT			
SENSORS:	705 km	ALTITUDE			822 km	SENSORS: HRV (x2)		
	99 min	PERIOD			101.4 min			
Thematic Mapper-TM	98°	INCLINATION			99°	MODES:		
6 bands - 30 x 30m	233	NUMBER OF PATHS			269	Multispectral		
1 band - 120 x 120m	16 days	EARTH COVERAGE			26 days	3 BANDS 20 x 20m		
Multispectral Scanner - MSS	185 km	SWATH			60 km/Imager	Panchromatic		
4 bands 60 x 80m	09:45	EQUATOR CROSSING			10:30	1 band- 10 x 10m		
MSS1	0.5-6.0	GREEN	TM1	0.45-0.53	BLUE	HRV/PADPCM	0.51-0.73	Panchromatic
MSS2	0.6-0.7	RED	TM2	0.52-0.57	GREEN			
MSS3	0.7-0.8	NEAR-IR	TM3	0.63-0.96	RED	HRV/MLA		
MSS4	0.8-1.1	NEAR-IR	3M4	0.76-0.90	NEAR-IR	HRV1	0.50-0.59	GREEN
			TM5	1.55-1.75	SWIR	HRV2	0.61-0.68	RED
			TM7	2.08-2.35	SWIR	HRV3	0.79-0.89	NEAR-IR
			TM6	10.8-12.5	TIR			

Source: RJGC, Canada-Jordan Remote-Sensing Project (Amman, 1989).

\* Reproduced as submitted.

TABLE 2. NOAA - AVHRR (ADVANCED VERY HIGH RESOLUTION RADIOMETER)\*

ORBIT	SPECTRAL BANDS
ALTITUDE: - 833km IFOV: - 1100m SWATH WIDTH: - 2400km REPEAT CYCLE: - 12hrs	Channel 1: 0.55 - 0.68 Channel 2: 0.725 - 1.10 Channel 3: 3.55 - 3.92 Channel 4: 10.5 - 11.5 Channel 5: 11.0 - 12.5

Data from the AVHRR are available in 5 operational modes:

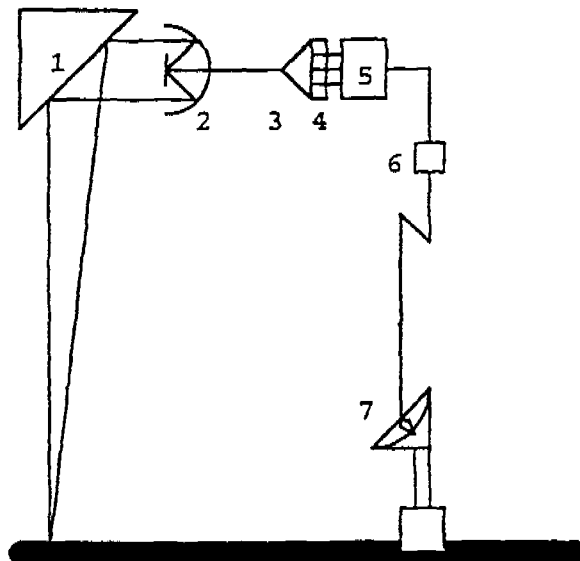
- 1: AUTOMATIC PICTURE TRANSMISSION (APT) - direct readout to worldwide ground stations of APT visible and IR bands at 4km spatial resolution.
- 2: HIGH RESOLUTION PICTURE TRANSMISSION (HRPT) - direct readout to worldwide ground stations of GRPT data for all spectral channels (1.1km resolution).
- 3: GLOBAL AREA COVERAGE (GAC) - global on-board recording of 4km resolution data from all spectral bands.
- 4: LOCAL AREA COVERAGE (LAC) - on board recording of data from selected portions of any orbit at 1.1km resolution in all spectral channels.
- 5: GLOBAL VEGETATION INDEX (GVI) - A NOAA/NESDIS product available since April 1982 produced from GAC 4km AVHRR data.

Source: RJGC, Canada-Jordan Remote-Sensing Project, Training Manual (Amman, 1989).

\* Reproduced as submitted.

Figure I. Choice of method of classification

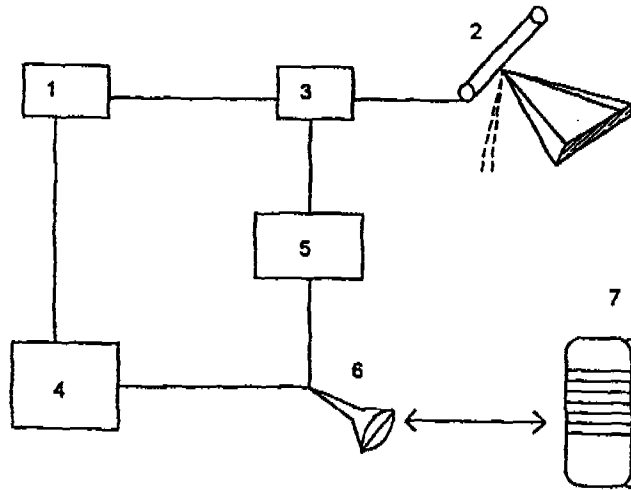
- 1- rotating mirror
- 2- optic system
- 3- dichroic grid
- 4- detectors
- 5- amplifier
- 6- transmission system
- 7- gr control station





**Figure II. Radar sensor**

- 1- generator of impulsion
- 2- antenna
- 3- interrupter
- 4- electronic clock
- 5- signal processing system
- 6- tube cathod
- 7- film recorder



The interval sampled by the continuous analog signal, and the instantaneous field of view during the scanning, define the spectral resolution of the system. The area formed by the basic picture element in the image restoration is called a pixel.

## B. DIGITAL IMAGE PROCESSING

A digital image is formed of picture elements (pixels). It is built up from lines of pixels. Each pixel location is defined by  $x$  and  $y$  coordinates. Each pixel has a digital value, called the radiometric value, corresponding to the brightness in spectral bands observed by the sensor. The radiometric of any three spectral bands forms a colour composite image. The colours normally produced on the RGB monitor are termed false colour composites, since true colour representation of the imaged portion of earth's surface, while often desirable, is rarely possible. The false-colour imagery requires a clear understanding of the image.

### 1. Pre-processing of image

Before image processing can begin, the intensity values of the image must be calibrated. Calibration involves making the intensity values of the image equal to the values measured by scanners at a height of few metres from the ground, and two identical bodies on the area under investigation must have the same intensity values.

### 2. Image restoration

The image restoration process recognizes and compensates for data errors, noise and distortion introduced in the scanning and transmission process; several corrections must then be made on the image, including the following:

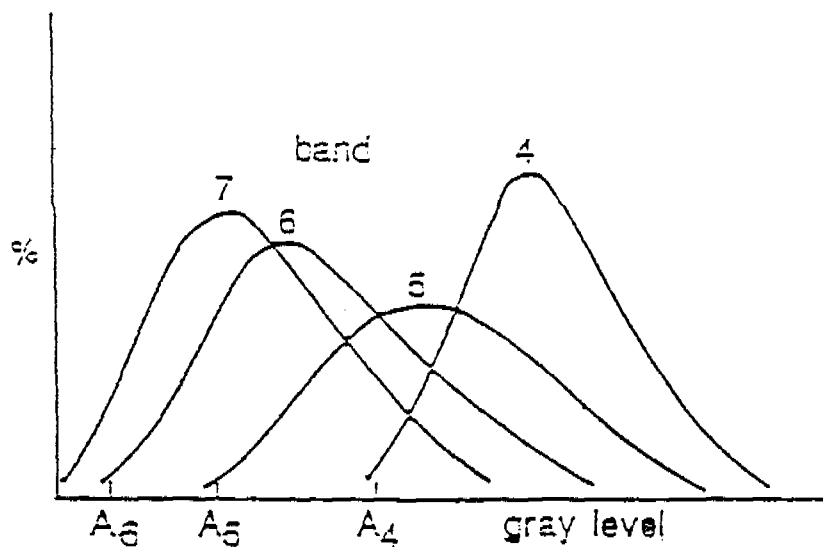
#### (a) Atmospheric correction

The shorter wavelengths of light are scattered by the atmosphere. The contrast ratio of the image is improved by correcting for the effects of this differential scattering. Two techniques are used to determine the correction factor for atmospheric scatter (or haze). Both techniques are based on the fact that band 7 (for

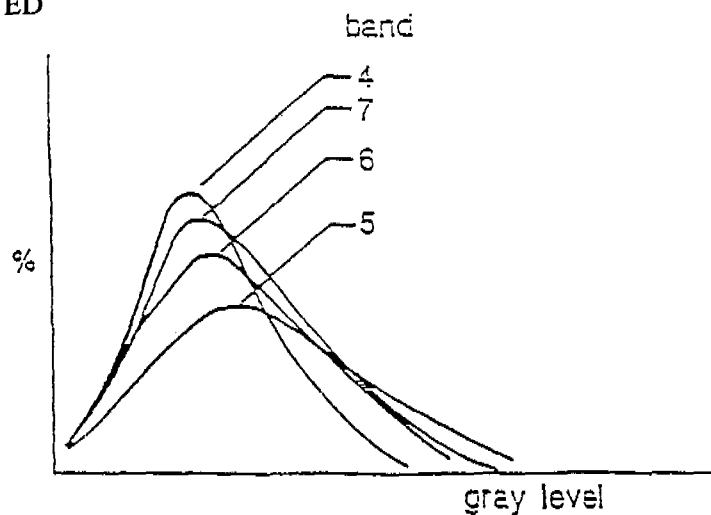
example, in Landsat), which has the least scattered light (0.8-1 lum), is essentially free of atmospheric effects, which can be verified by examining the DNs corresponding to bodies of clear water, and to steep shadowed slopes. Both the water and the shadows have values of either zero or one on band 7 (see figure III).

**Figure III. Correction for atmospheric scattering using multi-spectral image histograms**

(a) UNCORRECTED



(b) CORRECTED



DN	CRAY TONES	DN	CRAY TONES
1-10-15	1	6-34-37	6
2-16-19	2	7-38-42	7
3-20-24	3	8-43-46	8
4-25-28	4	9-47-50	9
5-29-33	5		

The basic correction employs an area within the image that has shadows caused by irregular topography. The digital numbers in band 7 are plotted against the values in band 4, and a straight line is fitted through the plot using a least-squares technique. The line in band 4 would pass through the origin. If there is no haze, the same thing can be done with bands 5 and 6.

(b) *Geometric correction*

There are many systematic geometric distortions and non-systematic geometric distortions which may be introduced into the image data. These distortions are corrected during the production of master images. Other distortions existing on the VVYs and images plotted from tapes have to be corrected as a final phase of the geometric correction.

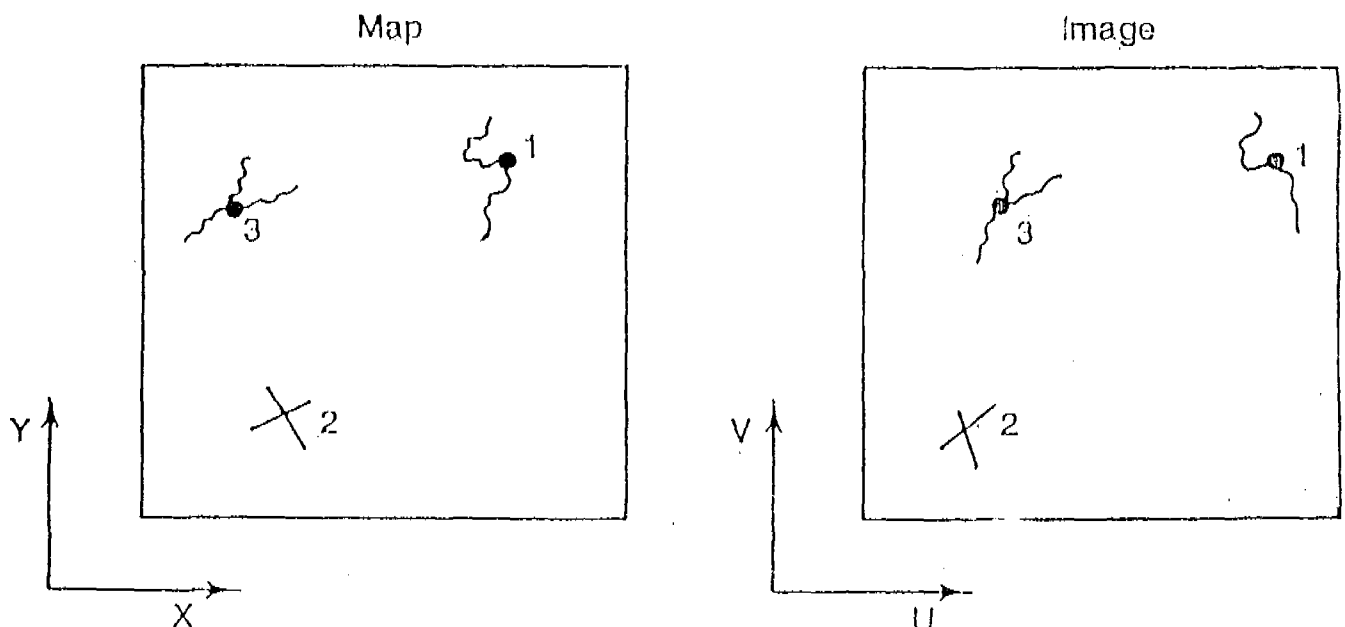
There are several cases of distortion errors:

(a) The rotation of the earth results in a distortion in the scan direction, which is a function of platform latitude and orbit. Altitude (roll, pitch and yaw) variations of the platform result in non-systematic distortions that must be measured for each image in order to be corrected;

(b) Scanner distortions result from sampling of data along the scanline at regular time intervals (the width of pixel 57 m for MSS);

(c) The velocity of the mirror in scanner sensors is not constant from the start to the finish of each scanline, resulting in an asymmetric distortion along each scanline. This effect can be corrected when the mirror velocity variations are known. To begin with, a correction is made for effects on sewer delay, earth rotation and mirror velocity, a photogrammetric procedure such as UTM projection or Lambert projection is then applied. This process identifies detectable and recognizable geographic features on the image, called ground control points (GCPs), whose positions on earth are known, such as intersections of roads, railways, rivers and bridges (see figure IV).

**Figure IV. Coordinate systems defined for the image and map, along with the specification of ground control points**

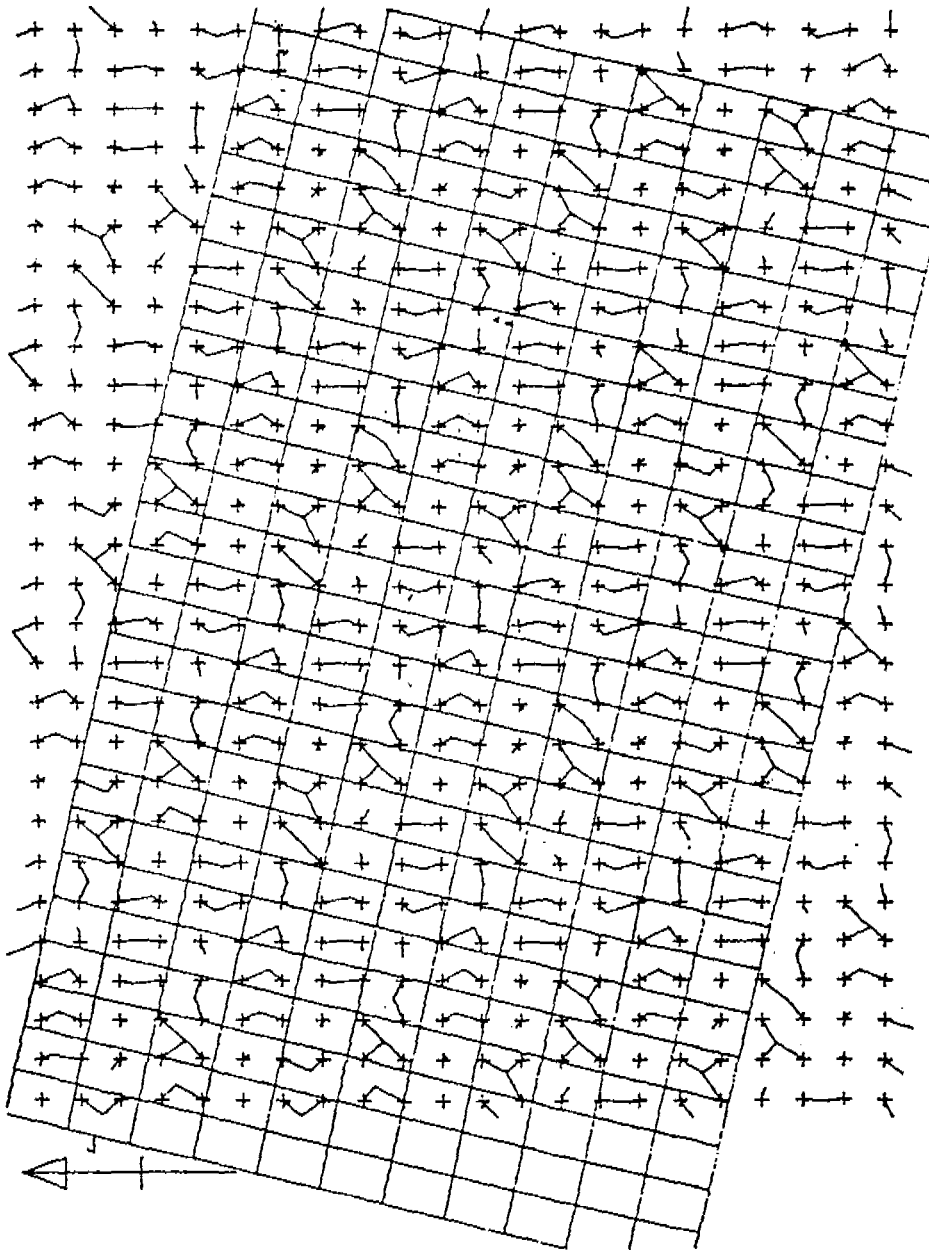


Differences between actual and observed GCP locations are used to determine the geometric transformation required to correct the image. A radiance value is assigned to each of these new grid points through a procedure called reassembling. There are at least three reassembling procedures in use:

- (a) Nearest neighbour procedure;
- (b) Bilinear interpolation;
- (c) Cubic spline interpolation.

In the nearest neighbour reassembling method, each ground pixel is connected by a short line to the centre of the nearest pixel (see figure V).

**Figure V. Landsat pixels fitted on 50.50 ground grid. Resampling by means of nearest neighbour procedure**



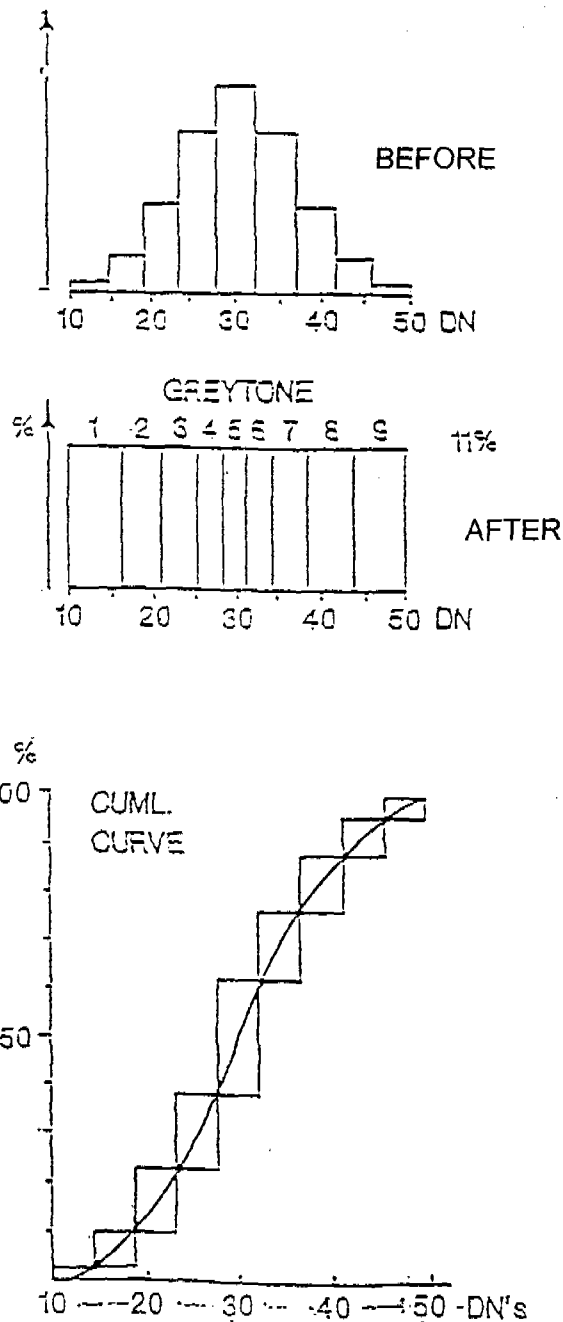
### 3. Image enhancement

The image must be modified to alter its impact on the viewer, but the distortion of the original digital values must be avoided. For this, the enhancement usually is not done until all the other processing steps, including the following, have been completed:

#### (a) Contrast enhancement

In general, electrostatic plotters are capable of producing a maximum of 10 gray tones; on the supposition that an image contains a range of digital numbers from 20 to 59, in this case four images are necessary to display the full range of digital numbers, as shown in the following list:

Figure VI. Histogram equalization



This results, in general, in a histogram with a contrast tendency. Each gray tone covers about 11% of the image, the pixels are distributed equally over the various classes represented by gray tones. This procedure is known as histogram equalization (see figure VI). The histogram equalization is important for the image production by the electrostatic plotter.

Contrast enhancement also includes linear contrast stretching.

A digital numeric value in the low range of the original is assigned to extreme black, and a value at the high end is assigned to extreme white. The remaining pixel values are distributed linearly between these extremes.

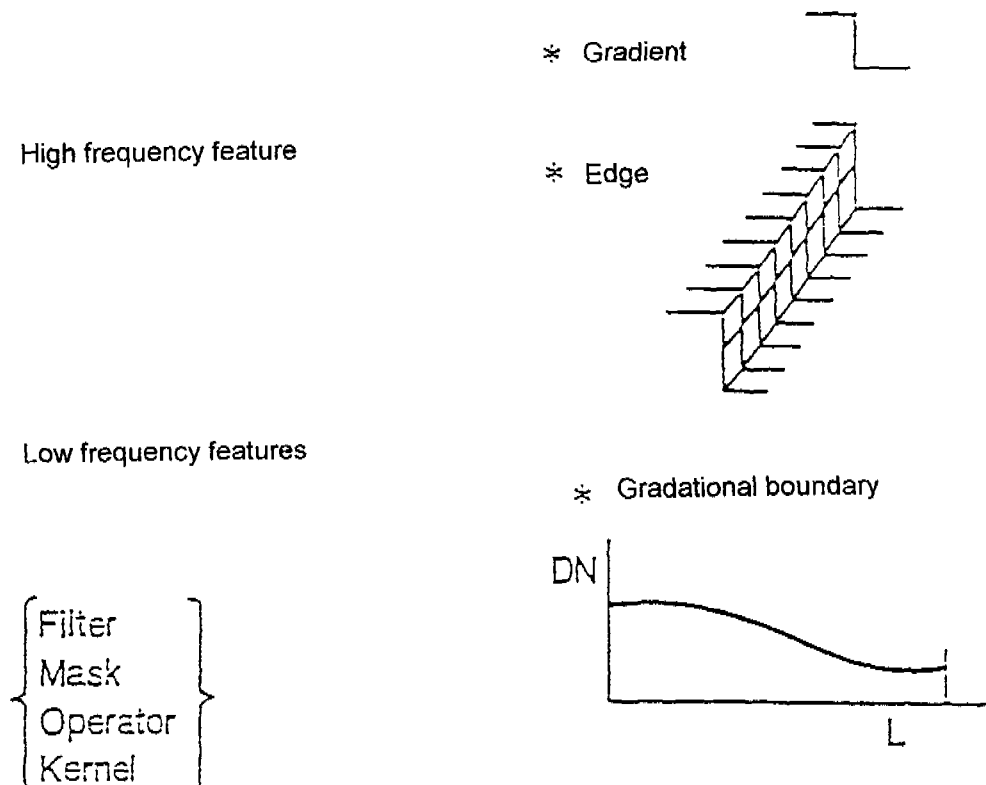
(b) *Density slicing*

Density slicing is a process that converts the continuous intervals, or slices, each of which corresponds to a specified digital range. Each digital slice is displayed in a separate colour. This process can be used for automatic classification.

(c) *Spatial frequency filtering*

It is known that a prism separates a beam of light into its component wavelengths; similarly, the waves can be separated into their component wavelengths by a mathematical process known as "spatial frequency filtering" (see figure VII). We change from the regular area to another. The boundaries, in this case known as "edges", occupy only a small area and are thus high-frequency features. The spatial frequency filtering improves the appearance of the spatial distribution of data in a digital image. This consists of selectively enhancing the high-, medium- and low-frequency variations of DN's in an image.

**Figure VII. Spatial frequency filtering**



The application of a filter to a digital image is called “convolution”. For this is chosen a “box filter”, meaning a matrix with, for example, three lines and three columns. This filter is placed over a 3x3 array of original pixels. Each pixel value is multiplied by the corresponding value in the filter. The nine resulting values are summed, and the resulting value replaces the original digital numbers of the central pixel. In other words, the output at a point is given by the sum of the input values around the points, each multiplied by the corresponding term of the filter mask. To compile the next output value, the filter mask is shifted one pixel position and the multiply and sum operations are repeated. There are two types of filtering: low pass filtering, and high pass filtering.

(a) *Low-pass filtering*: The application of a low-pass filter has the effect of filtering out the high and medium frequencies. The result is an image with a “smooth” appearance. This process consists of replacing the digital numeric of each pixel with the average digital numeric of the pixels surrounding it, including its own digital numbers;

(b) *High-pass filtering or edge enhancement filters*: Edge enhancement filters are the opposite of smoothing filters. There are two classes of high-pass filters: gradient filters and laplacian filters:

(i) *Gradient filter*: A digital gradient is computed by convoluting two windows with an image, one window giving the  $G_x$  component of the gradient ( $G$ ) and the other giving the  $G_y$  component; mask  $x = -1, 1$  mask  $y = 1, -1$ ;

$$\text{giving: } G_x(i,j) = V(i,j+1) - V(i,j)$$

$$G_y(i,j) = V(i+1,j) - V(i,j)$$

The magnitude  $GM$  of gradient can be computed from  $G_x$  and  $G_y$  by:

$$G_m(i,j) = (G_x^2 + G_y^2)^{1/2}$$

The angle  $G_a$  of a gradient can be computed as follows:

$$G_a(i,j) = \text{ARCTAN}(G_y/G_x)$$

Masks to enhance edges in: (a) a SW - NE direction: mask 1 =  $\begin{matrix} 1 & 0 \\ 0 & -1 \end{matrix}$

(b) a SE - NW direction: mask 2 =  $\begin{matrix} 0 & 1 \\ -1 & 0 \end{matrix}$

(ii) *Laplacian filter*: this is obtained by:

$$v''(i) = v'(i) - v(i-1)$$

The effect of the laplacian filter is stronger on an isolated point than on an edge.

#### 4. Feature space and information

(a) *Feature space*

Figure VIII shows the radiance of three different materials as a function of wavelengths. The radiance values of the materials in taking the wavelengths  $\lambda_1$  and  $\lambda_2$  as spots in a dimensional feature space are represented in the two-dimensional case of figure VIII. In figure VIII, the several types of ground cover can be discriminated because they occupy different locations in the feature space. For Landsat, with four bands, there are six possible combinations of two bands.

## 5. Classification

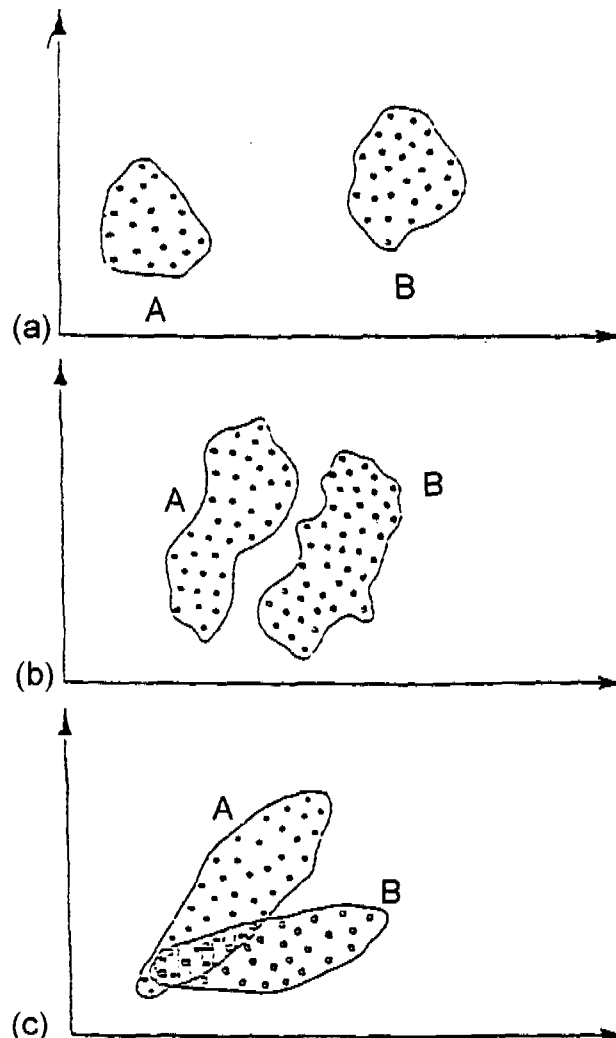
There are two kinds of classifications of digital data: supervised and unsupervised. There are two types of automatic classifications:

(a) *Supervised classification*: this type of classification calls for knowledge of some kinds of land use, known as ground truth, obtained through actual field surveys. Because features are checked on the ground, this type of classification yields good results.

(b) *Unsupervised classification*: ground truth is not used in this method of classification.

The spectral responses of the pixels of two classes of ground cover (A and B) are indicated in a 2-dimensional feature space. The unknown pixel  $x$  can be classified as belonging to the class of ground cover A according to the nearest neighbour principle. In the case of two elongated clusters for the classes of ground cover, the decision becomes more difficult with regard to classifying the unknown pixel  $x$ . Two overlapping clusters can be obtained as a result of the sampling of pure pixels of ground cover classes A and B. An unknown pixel which on the base of its spectral response is located in the overlap area can only be classified as either A or B. Overlapping clusters are quite common in Landsat data.

Figure VIII. Radiance of different materials





## **XII. PROJECT PLANNING AND DESIGN USING NEW TECHNIQUES (RS AND GIS)**

*by*

*Salem Al-Hussein\**

### **Introduction**

With the introduction of information technology (IT), the transfer of mapping technology has become more complicated and broader in scope and application. It requires different approaches for its institutionalization. This is caused by some of the characteristics of IT, such as the integrating, decentralizing and customizing aspects of this technology. Owing to these characteristics, the introduction of IT in conventional organizations, if not well conceived, can have detrimental effects.

#### **A. WHY IS WATER RESOURCES MANAGEMENT NECESSARY?**

Water resources management is necessary for the following reasons:

- (a) To improve water supply conditions for the growing human population;
- (b) To protect water quality from degradation and pollution;
- (c) To explore, improve and increase water production from new resources (including non-conventional resources);
- (d) To increase the effectiveness of economic systems in order to promote economic growth.

#### **B. WHY IS A WATER INFORMATION SYSTEM NECESSARY?**

A water information system is necessary for the following reasons:

- (a) Identification of problems and ineffectiveness in current use and of potential areas for improved production;
- (b) Formulation and implementation of water policies to address problems in such areas as water use and water supply, including new technologies for the production of additional water resources (such as desalination);
- (c) Monitoring of the development of water resources and complications that may arise with time.

#### **C. WHAT IS A GEOGRAPHICAL INFORMATION SYSTEM?**

A geographical information system (GIS) is a computer-based information system with functions for collecting, storing, processing, analysing and presenting data.

---

\* The author is a planning researcher at the Royal Jordanian Geographic Centre.

#### D. ELEMENTS OF A PROJECT PLAN

When a project is implemented, a plan for this project must first be prepared. This plan must contain a number of elements necessary for the accomplishment of the project. These elements can be summarized as follows:

(a) *Background:* Why has this project been initiated? Why is it important? What specific problems or issues is it intended to deal with? Who has initiated it? What data is already available on the areas covered by the project?

(b) *Project goals:* What is the project expected to achieve (stated in concrete, specific, measurable and meaningful terms)? How, specifically, are project results to be evaluated both during the project and at its conclusion?

(c) *Project plan:* What are the primary activities involved in this project? How much time is each activity expected to take? When are they to be initiated? When are they expected to be completed? Who, specifically, is responsible for ensuring that each activity is performed in accordance with expectations (tip: this is a good place to consider using a method such as Gant chart)?

(d) *Project organization:* How is work on this project to be structured? Who, specifically, will be involved in this project? If there will be a project management team, who will be its members? Why have these specific members been chosen? What are the specific expectations that have been placed on each individual working directly with or supporting this project? How much time will each team member be expected to commit? How will their normal task assignments be covered while they are serving on the project team?

(e) *Project budget:* Strictly speaking, there can be no project without a budget. What resources and support will be required (staff, material and equipment). How much are these resources expected to cost? When will they be needed?

#### E. PROJECT MANAGEMENT TASKS

The tasks required to be undertaken in the management of a project are the following:

- (a) To form a project planning group;
- (b) To gather and analyse data relevant to the intended project;
- (c) To survey the overall goals (expected results) of the project;
- (d) To identify the key tasks necessary for successful project completion;
- (e) To determine the competencies necessary within a project team in order for the team to perform its key tasks effectively;
- (f) To select the members of a project management team, the group of individuals who will have primary responsibility for designing and implementing the project;
- (g) To develop specific goals/outcomes for each of the key tasks involved in the project;

(h) To analyse each of the key tasks in terms of such things as time and resource requirements and their interdependence with other key tasks;

(i) Develop a detailed project plan, including interim goals (mileposts) against which progress can be measured;

(j) To ensure that organizational members including decision makers and stake holders affected by the project are kept informed;

(k) To evaluate the progress of the project against the defined interim goals (mileposts);

(l) To analyse the causes of any “gaps” between interim goals and actual levels of performance;

(m) To revise the project plan as and when necessary;

(n) To revise the project goals as and when necessary;

(o) To submit a final report, including “lessons learned”, during the project or after its completion.

In conclusion, the following quote from Winston Churchill is offered: “Planning is deciding to put one foot in front of the other”.

## **Bibliography\***

Ericsson, Agneta. Swedsurvey.

Groot, Richard. ITC.

Larsson, Thomas, and R.E. Zackrison, Ph.D. "Lectures at the advanced international training programme, Sweden: Strategic planning and leadership for the mapping and land information organization".

Rystedt, Bengt, Ph.D. Swedsurvey.

---

\* Reproduced as submitted.

### XIII. MONITORING OF RAINFALL AND EVAPOTRANSPIRATION VARIABILITY IN TIME AND PLACE

by

*Ali Sa'ad\**

#### Introduction

Jordan comprises an area of about 89,000 km<sup>2</sup>. From the surface-water point of view, Jordan is divided into 15 major surface-water basins or basin systems, some of which contain a number of sub-basins depending on the topography and the drainage characteristics. Figure I shows the major surface-water basins in Jordan.

#### A. TOPOGRAPHY AND CLIMATE

Although Jordan has a predominantly Mediterranean climate, large variations in topography result in different types of climate, reflecting variations in the amount of rainfall. The country can be divided into four areas of topographic relief, as follows:

(a) *Low land*: This area is located between the Jordan River in the west and zero elevation line in reference to the Mediterranean sea level; it is thus located totally below sea level (as low as 408 metres in some locations near the Dead Sea). The area covers about 2,540 km<sup>2</sup>. On average, this area receives rainfall varying from below 50 mm in the south to 400 mm in the north;

(b) *Western escarpment slope*: This part represents the area between the zero elevation line and the edge of the line connecting the highest points over the hills. These points have elevations of more than 1,600 metres above sea level. The area comprises some 4,100 km<sup>2</sup> and receives rainfall varying from 100 mm in the south to more than 600 mm in the mid-north, near the Ajloun hills, which is the area with the most rainfall.

(c) *Eastern escarpment slope*: This area covers some 8,100 km<sup>2</sup> from the beginning of the rain shadow region, which is located between the line connecting the top of the hills, mentioned above, in the west, and a line approximately coinciding with the isohyetal line of 150 mm in the east and south, where the flat desert begins. Rainfall varies between 150 mm in the east and south, and around 600 mm in the north-western part of the area;

(d) *Flat desert*: This area covers 73,760 km<sup>2</sup>, representing nearly 83% of the total land area of Jordan. It is located to the east and to the south of 150 mm isohyetal line, and it includes the southern part of the Wadi Araba and Aqaba areas. The mean annual rainfall over this area is normally from 150 mm to around 200 mm. Figure II illustrates the four climatological regions of Jordan.

#### B. RAINFALL MONITORING

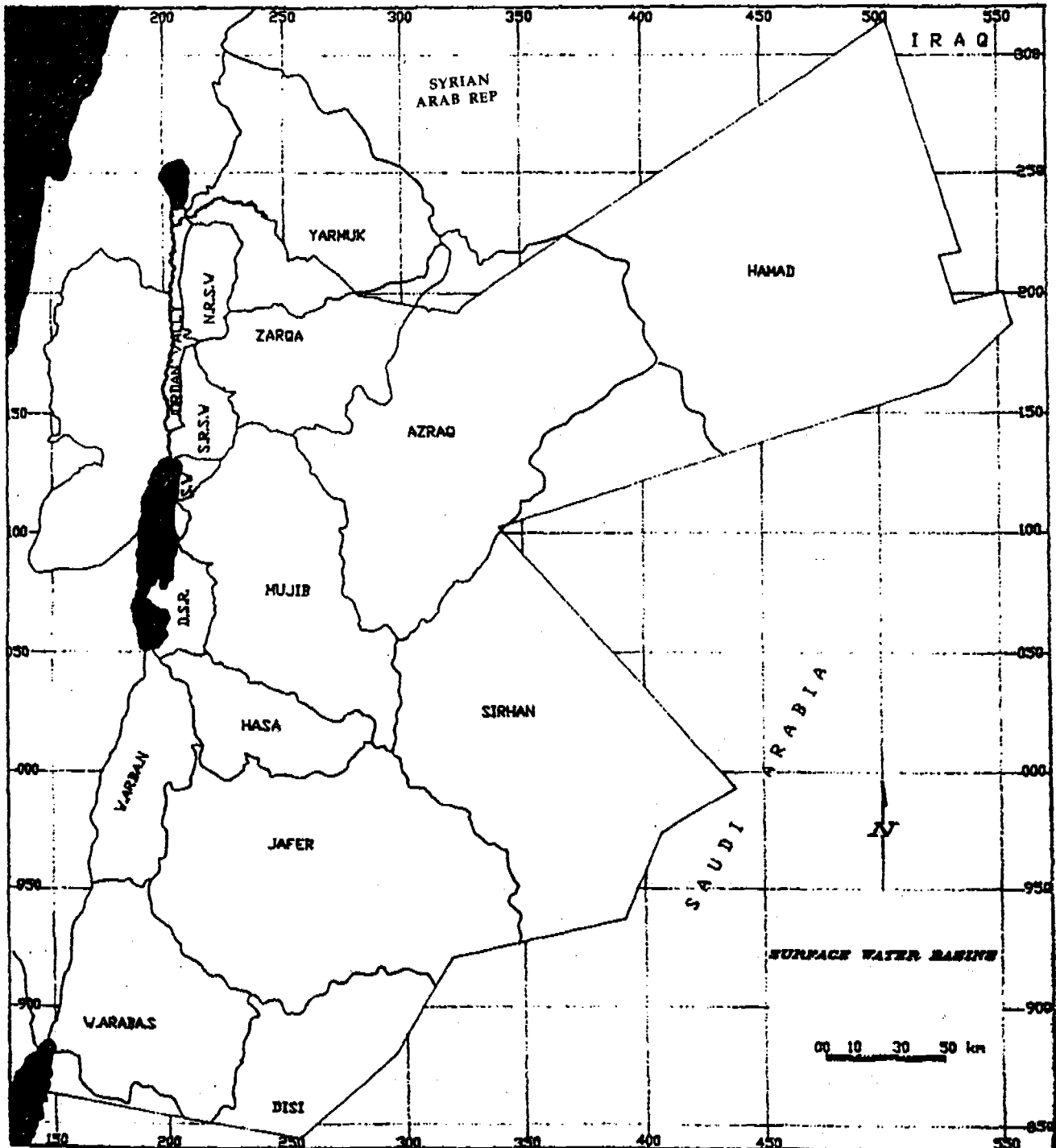
The precipitation-monitoring network is designed around the amount of precipitation received in Jordan. Precipitation occurs mainly as rain but can occur also as hail, sleet, snow, fog or dew. Rainfall amounts are recorded by more than 280 stations around the country, under the supervision of the Water

---

\* The author is a hydrological researcher at the Jordan Water Authority, Amman.

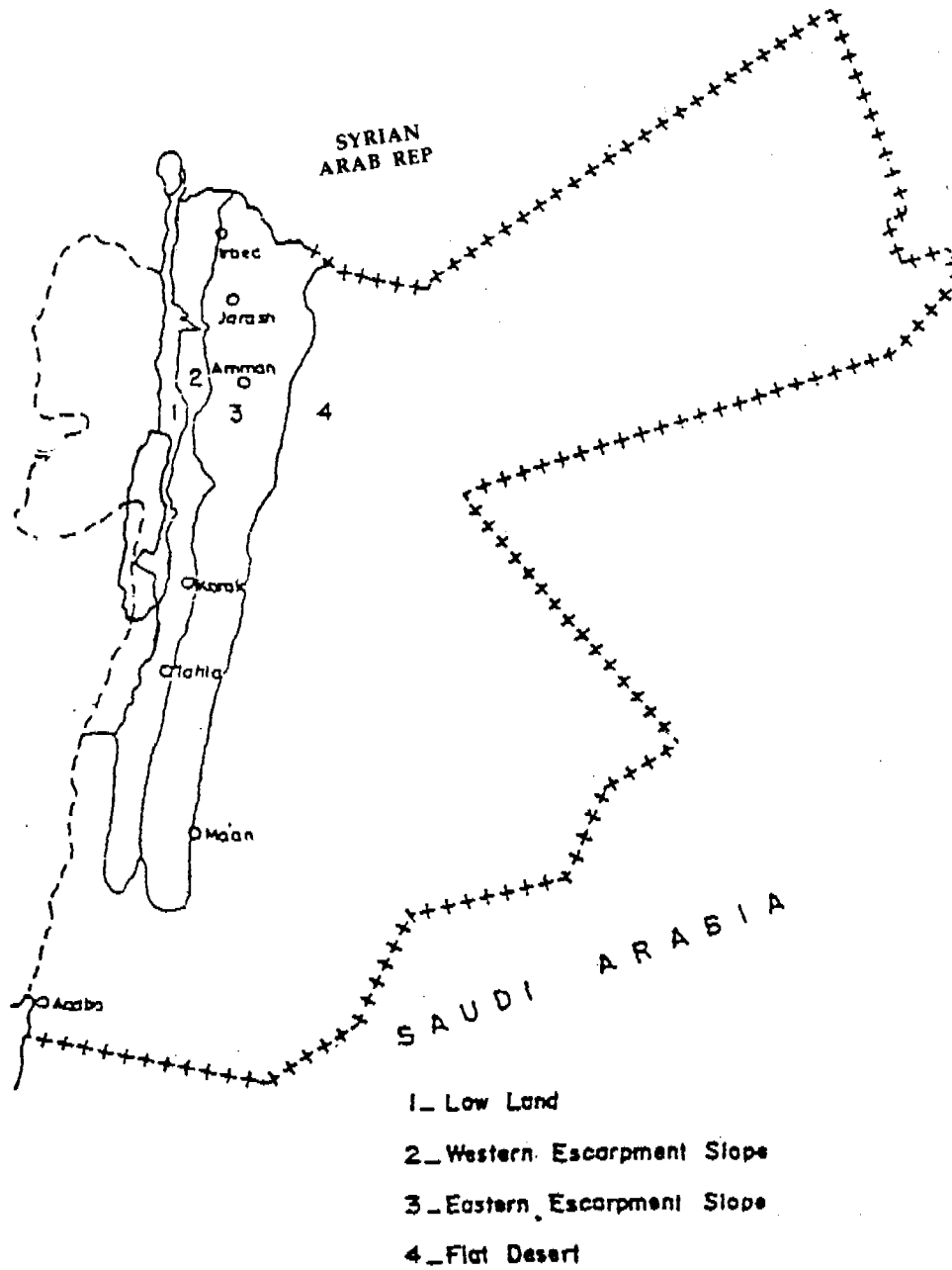
Authority of Jordan (WAJ); about 240 of these stations give daily rainfall values (80 are equipped with gauges that record rainfall continuously) while the remaining 40 stations are equipped with non-recording totalizers, which indicate total amounts over a given period.

**Figure I. The major surface-water basins in Jordan**



*The boundaries and names shown and the designations used on this map do not imply official endorsement or acceptance by the United Nations.*

**Figure II. The four climatological regions of Jordan**



*The boundaries and names shown and the designations used on this map do not imply official endorsement or acceptance by the United Nations.*

The standard daily rain gauges used in Jordan are made of galvanized iron and consist of a cylinder with a 16 cm diameter, and a chamfered upper edge that collects the rain and allows it to drain through a funnel into a removable metal container from which the rain may be poured into a glass graduated cylinder each day. Recording gauges (or autographic rain recorders) usually work by having a clockwork-driven drum carrying a graph on which a pen records either the total weight of the container plus the water collected, or a series of blips made each time a small container of a known capacity spills its contents. The tipping-bucket mechanism is usually used in most of the recording gauges in Jordan. Such gauges are more expensive and more prone to error, but they possess the great advantage of indicating the intensity of rainfall, which is an important factor in many hydrological problems. For this reason, some stations are equipped with both standard and recording gauges.

The totalizer (non-recording gauge) is made from the same material as the standard gauge. This gauge usually has an opening surface of 100 cm<sup>2</sup>. It has the advantage of being suitable for remote, rarely visited sites and is usually used for desert areas. In order to avoid evaporation of rain water during a long rainy season, some oil or diesel fuel is added to the container. At the end of the season, the total rainfall amounts are collected and measured after the oil and the water have separated.

### C. NETWORK OF EVAPORATION STATIONS

The monitoring of evaporation was started in 1965 at the Amman airport. Ten evaporation stations were added to the network in 1967, and another 10 stations were added between 1968 and 1970 for a total of 22 stations. They measured the wind velocity, temperature, sunshine hours or solar radiation, class A pan evaporation, humidity and rainfall. Although three of these stations were closed during the 1970s, more advanced stations were added during the 1980s, when 12 automatic stations were installed in the same locations as the old ones, and three more stations were installed in new locations to measure the climatological elements automatically and record them either on a cassette or on a memory card. The measured data are then transferred to a computer to be ready for use in different hydrological studies.

### D. INTERPRETATION OF PRECIPITATION AND EVAPORATION DATA

The data are collected periodically and analysed in the office. Afterwards, they are sorted, checked and entered into the computer. The precipitation data are used in the preparation of the isohyetal maps on an annual basis. At the WAJ, isohyetal maps are available for each year from 1937 to 1994 and have been entered into the computer by GDS. A 50-year average isohyetal map was also prepared and is shown in figure III.

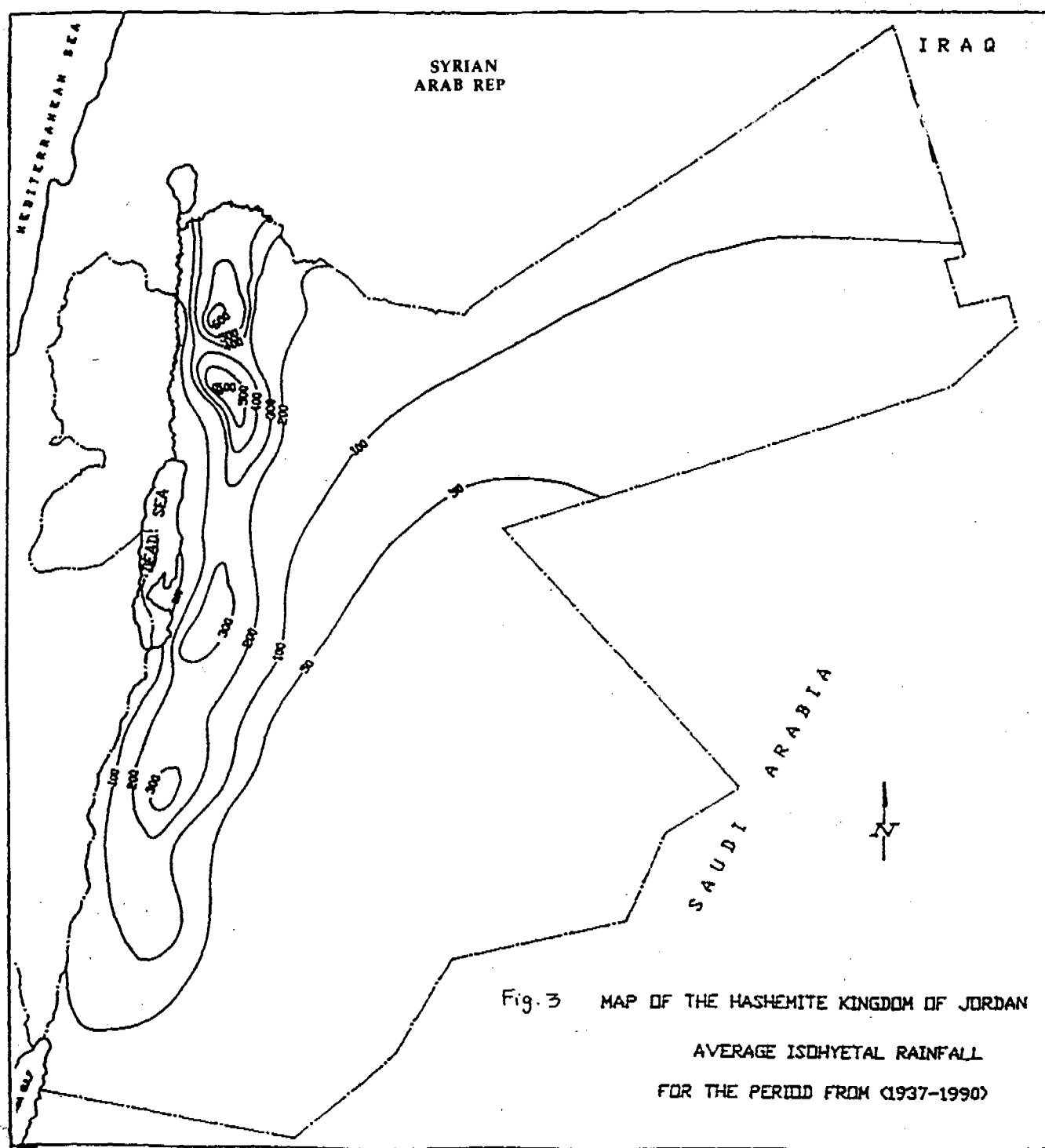
The data collected from the evaporation stations are used in the calculation of the evapotranspiration, which is important for estimating water consumed by plants in order to manage irrigation and water requirements. The evaporation/evapotranspiration data are also important in the water budget equation as they represent the principal way in which water resources are lost.

Penman's equation is mainly used for the estimation of evapotranspiration in Jordan, since no measurement of evapotranspiration is available. The equation is an empirical one and takes into consideration all climatological elements affecting the evaporation process; unfortunately, it gives the potential evapotranspiration in many cases rather than the actual one.

Actual evapotranspiration is calculated by means of the method used to calculate the water budget from storms rainfall (i.e., storm by storm), assuming that the potential evapotranspiration (ET) is equal to the actual ET during the storm.



Figure III. Isohyetal map of Jordan



*The boundaries and names shown and the designations used on this map do not imply official endorsement or acceptance by the United Nations.*

## E. RAINFALL VARIABILITY IN TIME AND SPACE

The annual rainfall volumes over Jordan were calculated from the annual isohyetal maps and are shown in table 1. The 50-year average of the annual rainfall volumes over Jordan was calculated as being equivalent to 8,424 mcm, while the 57-year average was found to be around 8,500 mcm. This means that only about 94 mm of the long-term average rainfall falls over Jordan annually. The average of dry years was found to be 6,235 mcm, and the average of wet years was found to be 10,629 mcm. The maximum of 7,800 mcm occurred in 1966/1967, and the minimum, observed in 1959/1960, was 3,915 mcm. Frequency analyses of rainfall levels in Jordan is shown in table 2.

TABLE 1. ANNUAL RAINFALL VOLUMES OVER JORDAN  
(*Million cubic metres*)

Year	Volume	Year	Volume
1937	9 979	1966	17 797
1938	10 904	1967	8 421
1939	10 908	1968	8 542
1940	8 320	1969	5 543
1941	9 793	1970	10 006
1942	10 926	1971	11 563
1943	8 943	1972	4 536
1944	13 403	1973	11 896
1945	7 982	1974	9 476
1946	4 806	1975	7 556
1947	6 980	1976	6 070
1948	9 668	1977	5 886
1949	10 237	1978	5 912
1950	5 521	1979	10 873
1951	11 627	1980	8 466
1952	8 675	1981	5 590
1953	8 504	1982	9 204
1954	6 725	1983	5 407
1955	8 553	1984	7 189
1956	9 879	1985	5 791
1957	4 855	1986	7 650

TABLE 1. (continued)

Year	Volume	Year	Volume
1958	6 386	1987	12 262
1959	3 915	1988	10 205
1960	4 896	1989	7 609
1961	7 495	1990	8 379
1962	5 497	1991	10 429
1963	11 679	1992	5 487
1964	10 857	1993	8 443
1965	6 936		

TABLE 2. RAINFALL VOLUMES AND FREQUENCIES

Return periods (years)	Volume of rainfall (1,000 mcm)
2	4.33
5	4.83
10	5.67
25	8.17
50	12.33
83	17.80

Figure IV shows the time distribution of the annual rainfall volumes for the period from 1937 to 1994, compared with the long-term average. The rainfall distribution for the different regions of Jordan was estimated using the 50-year-average isohyetal map. A percentage distribution of the areas between each isohyetal zone is shown in table 3.

The average annual rainfall amounts usually decrease from west to east and from north to south. Topography plays a significant role in the rainfall space variability.

#### F. VARIABILITY OF EVAPOTRANSPIRATION WITH TIME AND SPACE

Since the evaporation and evapotranspiration processes are dependent on numerous factors, such as availability of water, temperature, radiation and wind speed, which are not constant, the evapotranspiration (ET) values vary in time and space. The ET amounts are calculated for each basin separately and have been found to be about 79% of the annual precipitation in some basins, such as Kufrinja (up to 98%), Jafr and the southern desert areas. The long-term average of the actual ET percentage is around 92% as a weighted average for the entire country. Table 4 shows the water budget for basins in Jordan during 1993/1994. In order to give an idea about the time distribution of the annual ET values, an example of a water budget for the Amman-Zarqa area is given in table 5. The ET percentages can range from 66% to 90%, and the annual average is around 80%.

TABLE 3. AVERAGE RAINFALL DISTRIBUTION WITH ZONES IN JORDAN

Isohyetal zone (mm)	Approximate area of zone (km <sup>2</sup> )	Percentage of area in Jordan
600-700	135	0.15
500-600	495	0.55
400-500	1170	1.30
300-400	1800	2.00
200-300	1980	2.20
100-200	20070	22.30
50-100	27450	30.50
20- 50	36900	41.00

Figure IV. Rainfall volume for Jordan (1937/38 - 1993/94)

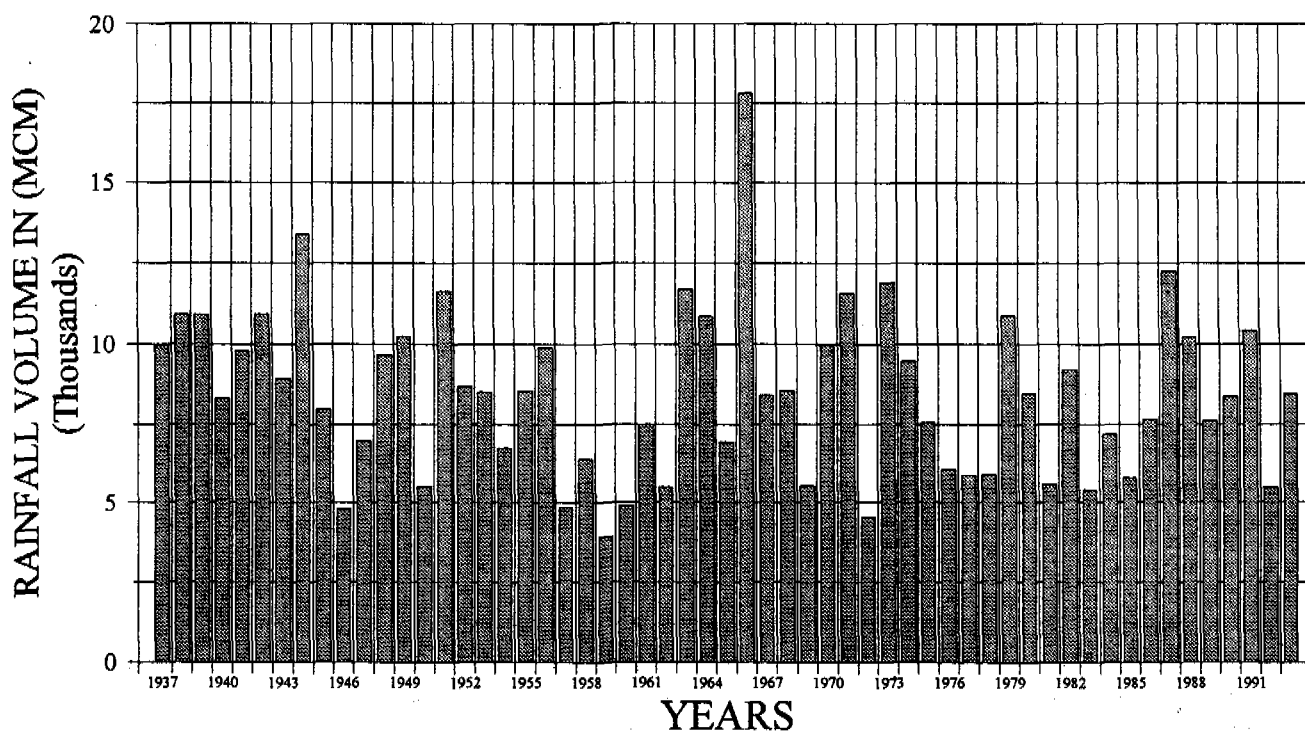


TABLE 4. WATER BUDGET FOR JORDAN 1993/1994

Basin name	Area (km <sup>2</sup> )	Rainfall		Runoff		Evaporati	Evaporati	Infiltratio	Infiltration (%)
		volume (mcm)	Runoff (mcm)	Coef. (%)	on (mcm)	on (%)	n (mcm)		
1 Yarmouk	1 500	316.6	11.08	3.50	288.10	0.910	17.41	5.50	
2 Jordan Valley	775	164.0	6.72	4.10	150.87	0.920	6.40	3.90	
3 N. Rift side wadis	975	361.2	8.67	2.40	303.39	0.840	49.12	13.60	
4 S. Rift side wadis	725	189.6	3.98	2.10	157.40	0.830	28.26	14.90	
5 Zarqa	3 725	1 307.4	26.15	2.00	1 189.72	0.910	91.52	7.00	
6 Dead Sea	1 525	318.4	7.96	2.50	286.55	0.900	23.88	7.50	
7 Mujib	6 675	827.5	27.64	3.34	753.02	0.910	46.84	5.66	
8 Hasa	2 600	318.1	9.54	3.00	286.29	0.900	22.27	7.00	
9 N. Wadi Araba	2 975	413.3	8.27	2.00	388.52	0.940	16.53	4.00	
10 S. Wadi Araba	3 725	256.6	3.85	1.50	251.49	0.980	1.28	0.50	
11 South Desert	6 300	223.7	2.46	1.10	219.25	0.980	2.01	0.90	
12 Azraq	12 200	637.5	15.94	2.50	606.88	0.952	14.66	2.30	
13 Sirhan	15 700	645.8	9.04	1.40	632.88	0.980	3.87	0.60	
14 Hamad	18 150	1 434.8	18.65	1.30	1 407.52	0.981	8.61	0.60	
15 Jafer	12 450	1 025.2	15.89	1.55	999.55	0.975	9.74	0.95	
All Jordan	90 000	8 443	175.84	2.08	7 921.43	93.820	342.40	4.055	

TABLE 5. WATER BUDGET FOR AMMAN-ZARQA AREA

Water Year	Rainfall volume (MCM)	Evapotranspiration volume		Runoff volume		Infiltration volume	
		(MCM)	(%)	(MCM)	(%)	(MCM)	(%)
1971/72	188	161.3	85.8	4.92	2.62	21.8	11.6
1972/73	121	106.8	88.3	3.77	3.12	10.4	8.6
1973/74	284	186.6	65.7	39.0	13.7	58.4	20.6
1974/75	153	127	82.8	4.87	3.2	21.5	14.0
1977/78	166	134	80.7	6.71	4.0	24.9	15.0
1978/79	93	78	83.7	3.34	3.5	11.9	12.8
1982/83	254	204	80.2	13.8	5.4	36.6	14.4
1983/84	148	133	89.9	4.17	2.8	10.7	7.3
Mean	176	141.4	80.3	10.1	5.7	24.5	14.0

Note: Catchment area = 680 km<sup>2</sup>.

## **XIV. DEVELOPMENT OF VEGETATION AND LAND USE IN THE ESCWA REGION**

*by*

*Hussein Harahsheh\**

### **A. LAND COVER/USE MAP**

#### **1. Introduction**

Land cover corresponds to the physical conditions of ground surface (for example: forest, grassland and concrete pavement), whereas land use reflects human activities (for example: industrial zones, residential zones and agricultural fields). Generally, land cover does not coincide with land use. A land use class is composed of several land covers, and remote-sensing data can provide land cover information rather than land use information.

Initially the land cover classification system should be established, which is usually defined in terms of levels and classes. Due consideration should be taken, in designing the levels and classes, of such things as the purpose of use (regional, national or local), the spatial and spectral resolution of the remote-sensing data, user's request (Japan, 1995a).

Accurate and up-to-date information based on the status and change pattern of land cover dynamics at the national, regional and global levels is a prerequisite for the sustainable management of natural resources inasmuch as policy decisions are made at different levels, and issues and priorities vary according to whether the concerns are national, regional or global in nature.

#### **2. Objectives**

The objectives of producing the land cover maps can be summarized as follows:

- (a) Regular assessment and monitoring of major land cover types in the study area;
- (b) Through regular monitoring, identification of "hot spot" areas (areas undergoing major land cover transformations) for detailed investigation using high-resolution satellite data supplemented by field verification. The information can act as an "early warning system" to priorities and direct scarce resources for an action plan;
- (c) To compile and analyse time-series land cover data at the regional scale;
- (d) The land cover map derived by using remote-sensing techniques is the basis of hydrologic response units. The multispectral classification of land cover was one of the first well established remote-sensing applications for water resources;

---

\* The author is a remote-sensing researcher, Royal Jordanian Geographic Centre.

(e) The vegetation pattern can provide information on the seasonal spatial rainfall. In fact, many remote-sensing experts consider the physical measurement of the hydrological variables by remote-sensing techniques to be a challenge to the application of these techniques in hydrology.

### 3. *Spectral reflectance of land cover*

Spectral reflectance is assumed to be different with respect to the type of land cover. This is the principle that in many cases allows the identification of land cover with remote-sensing by observing the spectral reflectance or spectral radiance from a location far removed from the surface.

Figure I shows three curves of spectral reflectance for typical land cover: vegetation, soil and water. As shown in figure I, vegetation has a very high reflectance in the near infrared region, though there are three low minima owing to absorption. Soil has higher values in almost all spectral regions, and water has almost no reflectance in the infrared region. Figure II shows two detailed curves for leaf reflectance and water absorption. Chlorophyll, contained in a leaf, has strong absorption at  $0.45 \mu\text{m}$  and  $0.67 \mu\text{m}$ , and high reflectance at near infrared ( $0.7-0.9 \mu\text{m}$ ). This results in a small peak at  $0.5-0.6 \mu\text{m}$  (green colour band), which makes vegetation appear green to the human observer. Near infrared is very useful for vegetation surveys and mapping because such a steep gradient at  $0.7-0.9 \mu\text{m}$  is produced only by vegetation. Because of the water content in a leaf, there are two absorption bands, at about  $1.5 \mu\text{m}$  and  $1.9 \mu\text{m}$ . This is also used for surveying vegetation cover. Figure III shows a comparison of spectral reflectance among different species of vegetation.

Figure IV shows various patterns of spectral reflectance with respect to different rock types in the shortwave infrared ( $1.3-3.0 \mu\text{m}$ ). In order to classify such rock types with different narrow bands of absorption, a multi-band sensor with a narrow wavelength interval is to be developed (Japan, 1995b).

### 4. *Land cover classification.*

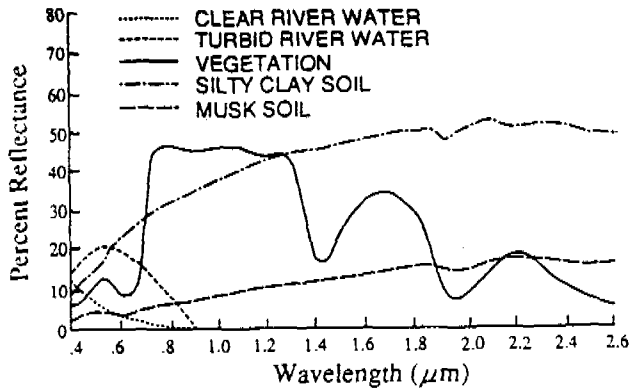
The classification of land cover/use types using remote-sensing data is generally carried out as follows:

- (a) Geometric correction of satellite data to a geographic coordinate system;
- (b) Collection of the ground truth data: ground truth is defined as the observation, measurement and collection of information about the actual conditions on the ground in order to determine the relationship between remote-sensing data and the object to be observed. Generally, ground data should be collected at a time when environmental conditions are not changing;
- (c) Classification techniques: classification of data gathered by remotely sensing is used to assign corresponding levels with respect to groups with homogeneous characteristics, with the aim of discriminating multiple objects from each other within the image. The level is called a class. Classification will be executed on the basis of spectral or spectrally defined features, such as density and texture, in the feature space. It can be said that classification divides the feature space into several classes based on a decision rule.

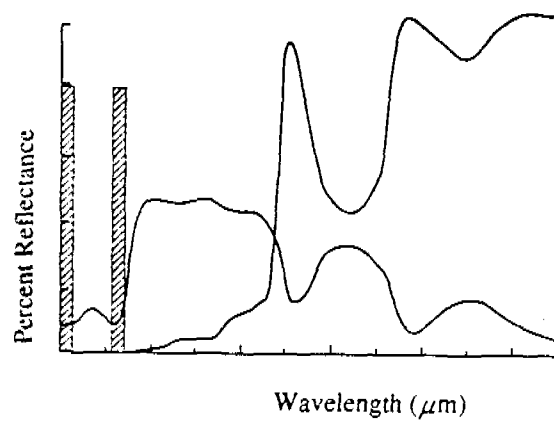
In many cases, classification is undertaken on a computer system with the use of mathematical classification techniques. Classification is done according to the following procedures, as shown in figure V:

Step 1: Definition of classification classes: depending on the objectives and the characteristics of the image data, the classification classes should be clearly defined;

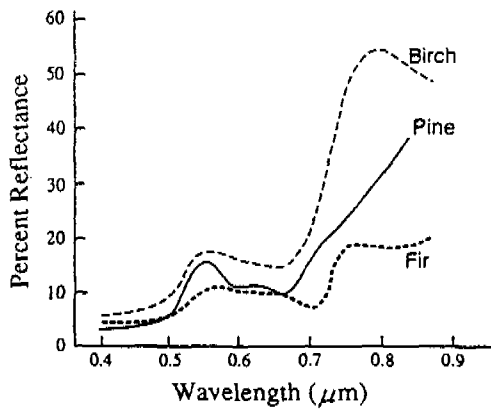
**Figure I. Spectral Reflectance of vegetation, soil and water**



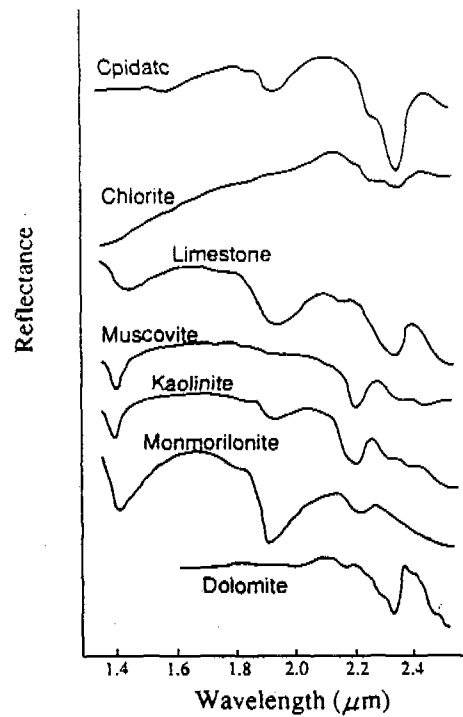
**Figure II. Spectral reflectance of a green leaf**



**Figure III. Spectral reflectance of different kinds of plants**



**Figure IV. Spectral reflectance of rocks and minerals**



Source: JARS, notes on remote-sensing (Tokyo, 1993).



Step 2: Selection of features: features to discriminate between the classes should be established using, *inter alia*, multi-spectral and/or multi-temporal characteristics and textures;

Step 3: Sampling of training data: training data should be sampled so that appropriate decision rules can be determined. Classification techniques such as supervised or unsupervised learning would then be selected on the basis of the training data sets;

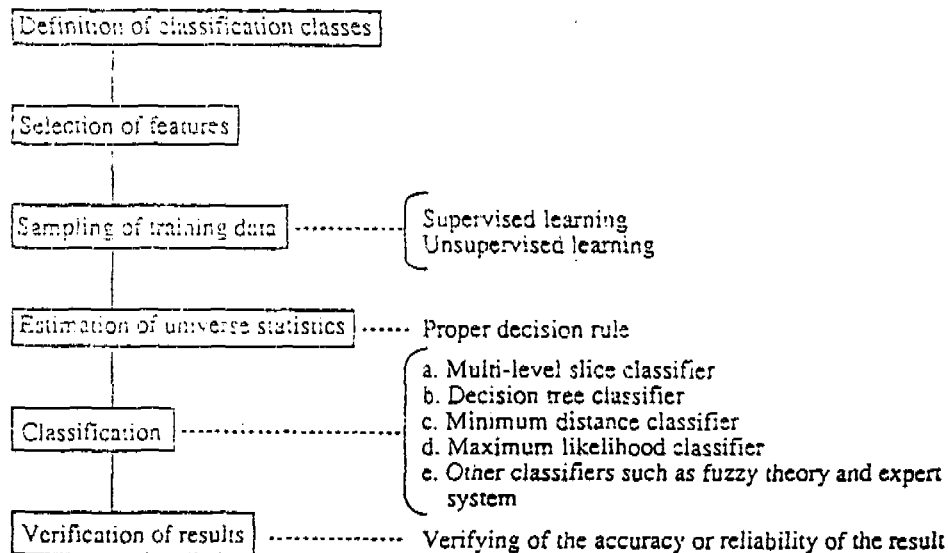
Step 4: Estimation of universal statistics: various classification techniques will be compared with the training data so that an appropriate decision rule can be selected for subsequent classification;

Step 5: Classification: depending on the decision rule, all pixels are classified in a single class. There are two methods of pixel-by-pixel classification and per-field classification, with respect to segmented areas. The usual techniques are as follows:

- (a) Multi-level slice classifier;
- (b) Minimum distance classifier;
- (c) Maximum likelihood classifier;
- (d) Other classifiers, such as fuzzy set theory and expert systems.

Step 6: Verification of results: the classified results should be checked and verified for their accuracy and reliability (Japan, 1995a).

**Figure V. Classification procedures**



### 5. Detection of land cover changes

It is necessary to be able to detect changes in land cover so that land cover maps can be updated and used for the proper management of natural resources. The change is usually detected by comparison between

two multi-data images, or sometimes between an old map and an updated remote-sensing image. The method of change detection is divided into two parts:

- (a) Comparison between two land cover maps which are independently produced;
- (b) Change enhancement by integrating two images into a colour composite or principal component image.

The land cover change can also be divided into two parts:

- (a) Seasonal change: agricultural lands and deciduous forests change seasonally;
- (b) Annual change: land cover or land use changes which are real changes (for example: deforested areas or newly built towns).

Usually, seasonal changes and annual changes are then mixed within the same image. However, only the real changes should be detected, so that two multi-data images from the same season are selected so as to eliminate the effects of seasonal changes. The seasonal change rate is sometimes very high (for example, in springtime in cold areas) (Japan, 1995a).

## 6. *Global vegetation map*

NOAA AVHRR data are very useful for producing global vegetation maps because NOAA has edited global cloud-free mosaics in the form of a GVI (global vegetation index) on a weekly basis since April 1982. The GVI data include information about NDVI (normalized difference vegetation index) and are computed as follows:

$$NDVI = \frac{Ch.2 - Ch.1}{Ch.2 + Ch.1}$$

Ch.1: visible band Ch.2: near infrared band

NDVI is sometimes simply called NVI (normalized vegetation index). NDVI or NVI are indicators of the intensity of biomass. The larger the NVI is, the denser the vegetation is. Although the original resolution of NOAA AVHRR is 1.1 km per pixel of the Equator, the GVI has a low resolution of 16 km x 16 km per pixel of the Equator. In spite of the low resolution, the GVI is useful for producing a global vegetation map (Japan, 1995a).

### B. CASE-STUDY: DEVELOPMENT OF VEGETATION AND LAND USE/ COVER MAP OF THE ESCWA REGION

#### 1. *Land cover/use map*

##### (a) *Introduction*

The broad goal of this part of the project is to assess the current status of major land cover types in the ESCWA region using NOAA AVHRR data (resolution = 1 km) and incorporating secondary information within the GIS environment and other sources. Among several types of satellite data available, NOAA AVHRR data has been selected primarily because of its high temporal resolution, low data volume, and low

cost compared with high resolution suitability, as opposed to Landsat and SPOT data. However, Landsat data were used in some cases, especially in the northern part of the ESCWA region.

(b) *Data acquisition*

A number of NOAA AVHRR scenes were acquired: one set for the wet season and another for the summer season, each set consisting of six scenes covering the total area of the ESCWA region. These data sets were found to be informative as regards distinguishing different forest types, and also in distinguishing forests from agricultural lands, as well as the delineation of major bodies.

(c) *Processing*

NOAA AVHRR data were analysed using Aries III image processing software. AVHRR data processing consists mainly of noise removal, enhancement, geometric correction and mosaicking and, as a final stage, data extraction.

(d) *Classification*

Visual classification was based on the false colour composite of NOAA imagery, bands 1 and 2, the existing atlas and geological map of the region and the vegetation index band. It was possible to delineate the following major land cover types:

- (i) *Agricultural land*: this class was extracted from the vegetation index band. The visual interpretation contains all kinds of vegetation except the forests;
- (ii) *Forests*: this class was extracted by visual interpretation of NOAA imageries, in addition to information found in atlases and other documents;
- (iii) *Grazing areas*: this class represents the land with a minimum of vegetation cover. The percentage of vegetation is estimated to be between 2% and 15%;
- (iv) *Sand dunes*: this class represents the sandy area without any vegetation activity;
- (v) *Basaltic areas*: blocks and stony areas without vegetation;
- (vi) *Basement areas*: blocks and mountains of basement material;
- (vii) *Distorted surfaces*: deformed and bad land, which is difficult to reclaim or manage;
- (viii) *Water bodies*: lakes, dams, rivers and major water bodies;
- (ix) *Main cities*: the main urban areas such as capitals and major cities in the ESCWA region;
- (x) *Sabkhat*: salt-encrusted flats on the shores of a lagoon or a shallow sea.

Figure VI shows the result of land cover analysis, and table 1 gives the statistical results of land cover classification.

TABLE 1. STATISTICAL RESULTS OF LAND COVER CLASSIFICATION OF THE ESCWA REGION

No.	Description	Area (km <sup>2</sup> )
1	Basaltic areas	14 387
2	Basement areas	402 461
3	Agricultural land	325 290
4	Grazing areas	1 816 394
5	Distorted surfaces	613 425
6	Sand dunes	1 119 741
7	Water bodies	21 719
8	Forests	26 298
9	Main cities (urban)	4 684
10	Sabkhat	90 694

## 2. Delineation of irrigated areas

The delineation of irrigated zones and the computation of their areas is significant for two reasons: first, to assess the vegetation density in the area; and second, to estimate the quantity of the abstraction from the underground and surface-water resources.

To estimate the quantity of water abstraction from the groundwater resources, it is important to distinguish areas that have been irrigated using surface water from those irrigated with groundwater resources and from rain-fed agricultural areas. Rain-fed and irrigated areas can be distinguished by the following:

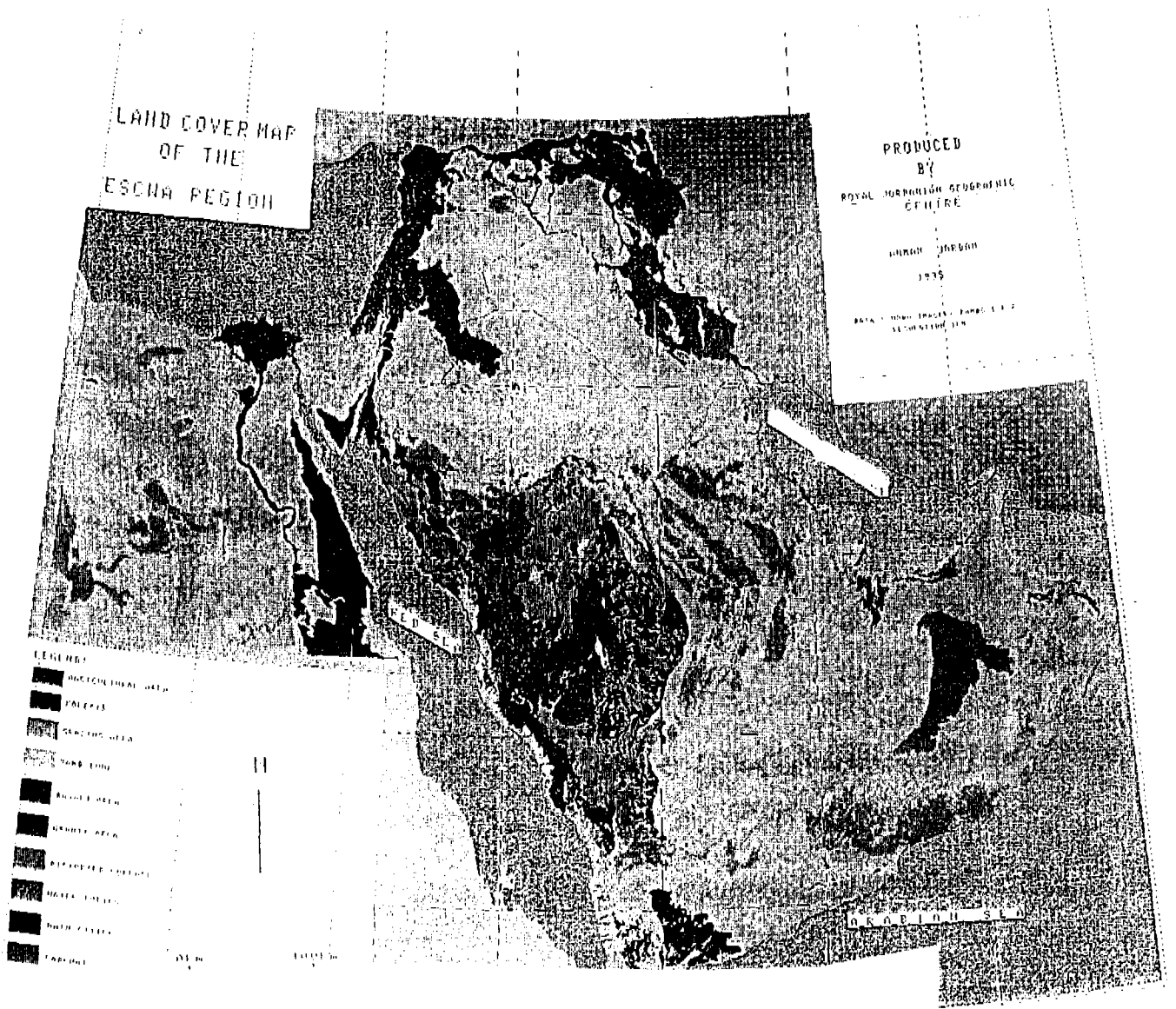
- (a) Irrigated areas have geometric shapes (for example, in pivot irrigation they consist of large circles);
- (b) Irrigated areas, contrary to rain-fed areas, have regular crop productivity, where the vegetation canopy is regular;
- (c) The high chlorophyll activities of the irrigated areas.

In order to distinguish between the areas irrigated with surface water, and those irrigated with groundwater, the satellite imageries were interpreted. As expected, lands located adjacent to the major rivers, such as the Euphrates, the Tigris, the Nile and the Shat El-Arab, are generally irrigated with surface water, whereas those in desert areas are irrigated with groundwater.

Landsat MSS imageries (resolution = 80 m) covering the areas of the Disi, Hammad and Dammam basins were corrected geometrically and enhanced using principal components as well as filtering techniques. MSS imagery has four bands with the following characteristics:

Band 1 (green)	ranges from 0.5 $\mu\text{m}$ to 0.6 $\mu\text{m}$
Band 2 (red)	ranges from 0.6 $\mu\text{m}$ to 0.7 $\mu\text{m}$
Band 3 (near infrared-NIR)	ranges from 0.7 $\mu\text{m}$ to 0.8 $\mu\text{m}$
Band 4 (NIR)	ranges from 0.8 $\mu\text{m}$ to 1.1 $\mu\text{m}$

**Figure VI. Land cover map of the ESCWA region**



*The boundaries and names shown and the designations used on this map do not imply official endorsement or acceptance by the United Nations.*

For the purpose of this work, three bands (1, 2 and 4) were selected. The vegetation index (VI) is applied using bands 2 and 4 in MSS imageries as follows:

- (a) V(b2) represents the radiometric values of band 2;
- (b) V(b4) represents the radiometric values of band 4.

### 3. Delineation procedure

Interpretation of the imageries of vegetated areas showed a variation in chlorophyll activity at different times of the year. Therefore, it became necessary to use additional indicators to distinguish between irrigated and rain-fed areas. The high chlorophyll activity means that there is high reflectance and therefore high values in the vegetation index band. The low-chlorophyll types can be distinguished by their geometrical shapes and the material added to the land as well as the high soil moisture, with respect to adjacent areas, which are mostly arid.

A composite imagery is formed from bands 1 and 4 and the vegetation index band. A visual interpretation is applied so as to distinguish between areas irrigated with groundwater and those irrigated with surface water. Table 2 shows the statistical analysis of irrigated areas.

TABLE 2. STATISTICAL CLASSIFICATION OF IRRIGATED AREAS OVER MAJOR AQUIFERS IN THE ESCWA REGION

Zone	Irrigated area (km <sup>2</sup> )	
	Surface	Ground
Dammam aquifer	943	8 481
Ordovician aquifer (Disi & Tabuk)	0	1 478
Ordovician aquifer (Buraida)	0	13 775
U-Cretaceous and Palaeocene	11	3 501
<b>Total</b>	<b>954</b>	<b>27 235</b>

## REFERENCES

1. Japan, 1993. Japan Association for Remote Sensing (JARS). Notes on Remote Sensing. Shunji Murai.
2. Japan, 1995. Proceedings of the International Symposium on Vegetation Monitoring, Chiba, Japan, 29 to 31 August 1995.
3. Harris, Ray, n.d. Satellite remote sensing: an introduction.

## XV. SOIL MOISTURE AND SOIL EROSION

by

*Munther Karraz\**

### A. SOIL MOISTURE

#### *Presence of water in the soil*

Water can be present in soil as solid (ice), liquid or vapour. The liquid phase is the main concern in the present paper. Water in soil serves as: (a) a leaching agent; (b) a solvent; (c) a reactant; (d) a medium for chemical reaction; and (e) a plasticizing agent. The physical behaviour of soil water depends on the soil properties; such as texture, pore space and density.

Soil pores can be filled with air, water or both. The availability of water and air in the soil pore is the most desirable from the point of agriculture. Therefore, two types of porosity can be distinguished: air-filled porosity; and water-filled porosity. Water-filled porosity is often called soil water content and is more commonly expressed as the "dry weight soil moisture fraction". Moisture content can be estimated using the following equation:

$$\theta_v = \frac{w}{d} \times \frac{\rho_b}{\rho_w} \times 100$$

where  $\theta_v$  = moisture content as a percentage on volume basis  
w = mass of water  
d = mass of dry soil  
 $\rho_b$  = soil bulk density  
 $\rho_w$  = water density.

### B. SOIL WATER RELATIONS

The soil/water relations can be divided into two main categories:

#### (a) *Water-transmitting properties of the soil*

Water movement in the soil is governed by gravity force, capillary force (or both), and by soil permeability, which depends on saturation conditions. In order to provide a better understanding of the dynamics of water movement, the following concepts are defined:

- (i) *Soil permeability*: in a quantitative sense this is the readiness with which a soil transmits water. For a more precise definition, a distinction should be made between:
  - a. The surface intake rate, which determines the relation between water absorption and run-off;
  - b. The subsurface percolation rate, which determines the internal soil drainage;

---

\* The author works for the Ministry of Agriculture, Amman.



- c. Hydraulic conductivity, which is the proportionality constant depending on the nature of the soil and fluid (water).

The above-mentioned three aspects of the soil permeability are shown in table 1. The intake rate (infiltration rate) refers specifically to the entry of water into the soil surface, and its transmission and storage. The percolation rate also refers to vertical permeability and may be defined as the quantity of water passing through a unit of area of a cross-section per unit of time at a given depth in the soil mass;

TABLE 1. ASPECTS OF SOIL PERMEABILITY

Zone	Layer	Factor	Water flow condition	Measurement	Objective
Topsoil		Infiltration rate	Unsaturated	Infiltrrometer (dry run)	Application of irrigation water
Subsoil					
Substratum	Dense layer	Percolation rate	Nearly saturated	Infiltrrometer (wet run)	Internal drainage
	Groundwater	Hydraulic conductivity	Saturated	Auger hole method	Subsurface drainage

- (ii) *Internal drainage of the root zone:* the term “internal drainage” refers to the root zone’s property of permitting excess water to flow through it in a downward direction. Poor internal drainage is revealed when the infiltrating water becomes stagnant at the soil surface in a pervious layer. The presence of an impervious layer will generate what is known as a perched water table, where the water table is formed at the boundary of a saturated zone.

(b) *Water-retaining properties of the soil*

The capacity of a soil to retain moisture for plant growth is an important factor in agricultural land-use planning. This applies not only where there is adequate rain, but also in irrigation projects.

The term available moisture (AM) is the moisture-holding capacity of the soil between the field capacity and the wilting point of a given soil layer. The field capacity is the percentage of water remaining in the soil after it has become saturated and when free drainage has practically ceased under the influence of gravity.

Experience has shown that for many deep, homogenous and freely draining loams, the moisture tension at field capacity equals about  $-\frac{1}{3}$  atmosphere (atm). Hence, the moisture content of a soil sample equilibrated at  $\frac{1}{3}$  atm pressure is commonly used instead of the field capacity.

The wilting point (permanent wilting point) is the point at which the moisture content is such that most plant roots are no longer capable of drawing water from the soil, and the plants suffer irreversible wilting. Experience has shown that the moisture tension at wilting often equals  $-15$  atm. Soil classification according to physical characteristics is shown in table 2.

TABLE 2. PHYSICAL CHARACTERISTICS OF SOIL

Texture	Percentage				
	To pore space	Wilting point	Field capacity	AM <sup>a</sup>	Bulk density
Loamy sand	42	6	14	8	1.55
Sandy loam	44	9	21	12	1.5
Loam	46	14	30	16	1.4
Clay loam	49	17	36	19	1.35
Silty clay	52	21	41	21	1.3
Clay	53	23	43	20	1.25

a/ AM = available moisture.

The available moisture (AM) for a soil layer can be calculated as:

$$AM = \frac{\theta_{F.c} - \theta_{w.p}}{100} \times ds$$

where  $\theta_{F.c}$  = moisture content at field capacity on volume basis

$\theta_{w.p}$  = moisture content at wilting point on volume basis

ds = thickness of the soil layer.

$$TAM = \sum_{n=1,2,\dots} AM(n)$$

where TAM = Total available moisture potential rooting depth of the soil profile

AM = Available moisture

n = 1,2... number of soil layers.

It must be borne in mind that not all the total available moisture (TAM) may be considered readily available for use by plants.

### 3. Water retention mechanisms in the soil

The forces of retention depend on the dominance of adsorption or adhesion forces, defined as follows:

(a) *Adsorption forces*: several mechanisms are active in the adsorption of water by soil particles. Those resulting from the electrostatic charge of soil particles and the absorption of counterions only act over a short range. This strong binding force creates a very thin film of water;

(b) *Adhesion-cohesion forces*: large amounts of water can be retained in soil results owing to the presence of an air-water interface. Surface tension is caused by the mutual attraction of water molecules

(cohesion), and adhesion is related to the liquid/solid contact. These forces act together as matrix forces as a result of the presence of the soil matrix.

#### 4. *Moisture retention curves*

The graph giving the relation between soil moisture tension and soil moisture content is called a moisture retention curve (see figure 1). If the moisture tension is expressed as the logarithmic value of the water head (cm), the graph is referred to as a PF curve. A moisture retention curve is used for the following purposes:

- (a) To determine an index of the available moisture in the soil and to classify soils accordingly (such as for irrigation purposes);
- (b) To determine the drainable pore space for drainage design;
- (c) To check changes in the structure of a soil, such as those caused by tillage or mixing of soil layers;
- (d) To ascertain the relation between soil moisture and other physical properties of a soil (for example, thermal conductivity).

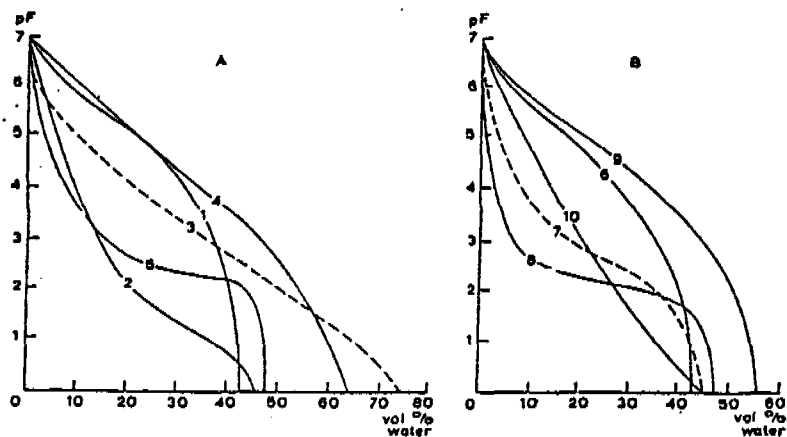
#### 5. *Measuring soil moisture conditions*

There are several methods for measuring the soil moisture content. The most frequently applied methods are the following:

- (a) *Gravimetric determination of soil content:* the gravimetric method involves weighing the natural (wet) soil sample, and reweighing it after the water has been removed by drying in an oven at 105°C. The difference in weight indicates the moisture content and is expressed either as a percentage of the weight or volume of oven-dry soil. The gravimetric method is considered simple and reliable. It is the most applied technique and is used as the calibration standard for other methods;
- (b) *The use of a tensiometer:* a tensiometer consists of a porous cup positioned in the soil and attached to a tube which is connected to a vacuum gauge. The cup and the tube are filled with water, and water flows into or out of the cup, through the cup wall, as long as there is a moisture tension gradient between the water in the cup and that in the soil. Practical use is restricted to the range of 0-800 cm water tension ( $PF < 2.9$ ) because at higher tensions air leaks through the wall of the porous cup;
- (c) *Electrical resistance units:* the principle of the electrical resistance unit is based on the change in electrical resistance in a porous material as a result of a change in moisture content. Resistance units consist of two parallel electrodes embedded in gypsum, nylon, fibreglass or a combination of gypsum and nylon or fibreglass. The resistance to an electrical current is dependent on the moisture condition of the unit which itself is at moisture tension equilibrium with the surrounding soil. It can be measured by means of a Wheatstone bridge. The electrical resistance method is not suitable for soils showing shrinkage (characteristics);
- (d) *Neutron scattering:* the neutron-scattering method is based on the fact that fast-moving neutrons emitted by a radioactive source (plutonium-beryllium or americium-beryllium) are slowed down by collisions with the nuclei in the soil and can be counted by a detector. The measured density of slow

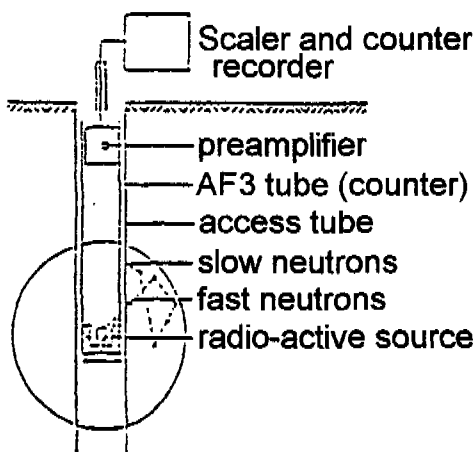
neutrons is an indication of the moisture content of the soil. A portable probe unit is used to carry out a scaler calibration of the relation between count rate and moisture content (figure II);

**Figure I. Soil moisture retention curve**



No.	Soil Type	Depth in cm.
1	Heavy clay	40 - 50
2	Sandy yellow latosol	100
3	Peat	0 - 20
4	Marine (sal.) clay deposit	5
5	River levee clay	20 - 40
6	Clay	—
7	Sandy loam	20
8	Sand	—
9	Salty clay	40 - 60
10	Podsol, red fine sandy clay	100

**Figure II. Neutron moisture meter**



**Neutron moisture meter**

(e) *Gamma radiation probe*: based on the interreaction of gamma rays with the electrons of soil where photoelectric absorption has occurred, thus causing a reduction in the number of gamma photons reaching the detector.

The advantages and disadvantages of each method are shown in table 3.

Table 3. PRINCIPAL MERITS AND LIMITATIONS OF THE COMMON METHODS OF SOIL MOISTURE MEASUREMENT

METHOD	MERITS	LIMITATIONS
Sampling (gravimetric)	Complete moisture range, not sensitive to salt and temperature, reliable (used as calibration standard)	Not reproducible, high sampling error, volume weight to be known, laborious
Tensiometer	Direct measurement of moisture tension, reproducible	Limited tension range, hysteresis effect, contact with soil (particularly in swelling and shrinking soils), apparatus fragile
Electrical resistance blocks (gypsum and nylon units)	Practically complete moisture range, reproducible	Sensitive to temperature and salt (especially nylon units), hysteresis effect, contact with soil, calibration, limited life in wet, acid soils (particularly gypsum units)
Neutron scattering	Complete moisture range, reproducible, no salt and temperature influence, relatively large horizontal distance	Apparatus fragile and expensive, relatively large vertical distance, deviations due to high amounts of organic matter and uncommon excesses of B, Cl and Fe
Gamma radiation adsorption	Complete moisture range, reproducible, relatively large horizontal and small vertical distance, no salt and temperature influence	Apparatus fragile and expensive, volume weight to be known

## B. SOIL EROSION

The simple definition of soil erosion is the detachment and removal of soil particles from the surface of the ground by the action of either wind or water. There are two types of erosion:

(a) *Geologic erosion*: in the broadest sense, geologic erosion is a normal process involving the erosion of land in its natural environment without the influence of man. Geologic erosion has been occurring since the emergence of the continents. It is caused by the action of wind, water, temperature fluctuations, gravity and glaciers. It is responsibility for the wearing away of the hills and mountains and is the cause of current surface features such as sculptured hills and mountains, canyons, plains, deltas and stream channels. Geologic erosion includes soil forming as well as the erosion process;

(b) *Accelerated erosion*: accelerated erosion is an excess of geologic erosion and is induced by man's activities, which have brought about changes in the natural cover and the soil condition. Such activities include land preparation for food and fibre production and removal of trees and bushes for energy or to increase the area to be tilled, where the unprotected surface is exposed to erosion. The disappearance of the topsoil and the exposure of subsoil lead to a reduction in the infiltration rate and a reduction in the depth of moist soil profile. This results in greater runoff and accelerates the erosion rate.

### 1. *Water erosion*

#### (a) *Sheet erosion*

Sheet erosion is the even removal of a thin layer (sheet) of soil, by rain and running water, from a given area of sloping land. The total amount of soil removed in a single storm is usually small. The results of sheet erosion often show up as light-coloured patches of soil on hillsides. Sheet erosion involves the detachment of soil particles by the raindrops (splash effect) and the carrying away of these particles from their original location. When the rate of rainfall exceeds the soil intake (infiltration rate), water starts to flow over the sloping land, picking up the detached soil particles and carrying them away. The flowing water may move as a thin sheet, and this is called sheet flow. The eroding and transport power of the sheet flow depends on: (i) the depth and velocity of the sheet flow; and (ii) the soil structure. Studies indicate that the maximum movement of soil particles occurs when the depth of the sheet flow equals the diameter of soil particles.

#### (b) *Micro-channel or rill erosion*

Sheet flow occurs mainly when the ground surface is smooth and uniform. This condition is virtually non-existent in cultivated areas because of the tillage implements. The surface irregularities create low places and high places. Consequently, as water from rain accumulates in depressions and then begins to flow in micro-channels or rills, they vary in size from minute channels to a size that is easily observable. After rills develop, sheet erosion may take place, especially in the smooth areas located between the rills.

In rill erosion, detachment and transport of soil particles is greater than in sheet erosion owing to the fact that the amount of flow and velocity in rills is much higher than in sheets. Rill erosion removes some topsoil and may extend into the subsoil, whereas sheet erosion removes only the topsoil.

#### (c) *Gully erosion*

Gully erosion is channel erosion that cuts so deeply into the soil that the ground cannot be smoothed by tillage operations. This type of erosion often follows sheet and rill erosion. Gullies may be narrow and only two to three feet deep or may reach 10-12 metres deep and 20-30 metres wide. The cross-section of gullies has a V or U shape. The V shape occurs where the subsoil resists the rapid cutting because of its toughness; the U-shaped gullies are found in regions where both the surface and subsurface soil are easily eroded.

#### (d) *Stream bank erosion*

Intermittent streams in semi-arid regions usually experience torrential flows, heavily laden with rocks and other sediment. It usually lasts a short time and has a relatively high rate of peak discharge. This causes tearing and cutting of the banks, especially on the outside of the curve. The bank erosion in this type of stream is characterized by under-cutting and collapsing of the wall on the outer curves.

(i) *Sedimentation*

Soil that is eroded from its original location is deposited elsewhere. The distance travelled by the eroded soil particles depends on: (a) size of the soil particles; (b) density of the soil particles; and (c) the shape and velocity of the water. Coarse sand particles move the shortest distance and settle in first; fine sand and silt drop in next as run-off water slows down; very fine silt settles in stagnant water; clay particles remain in suspension until coagulated by a specific concentration of electrolytes (salts) in water.

a. *Land sedimentation*

The bulk of eroded material from hillsides comes to rest at the foot of slopes or nearby flood plains, where the material has moved a relatively short distance. Some of it may find its way into large rills, gullies or small streams and may be carried away and deposited as a small alluvial fan. Much of the damage is caused by local sediment which is deposited in farm fields, burning growing crops, damaging field irrigation and drainage networks, and decreasing the amount of live storage in local reservoirs.

b. *Downstream sedimentation*

Eroded material often travels great distances from the source of erosion; it is carried out into a large stream and transported in two ways: as a suspended load, or as a bed load. Damage caused by downstream sedimentation can be divided into three categories: (a) channel sedimentation; (b) filling of reservoirs; and (c) sedimentation on bottom lands.

(ii) *Physical conditions affecting water erosion*

The following factors play a significant role in the water erosion process:

(a) *Slope factor*: this consists of the steepness of the slope (S) and the length (L). Wischmeir derived the following equation for slope factors:

$$LS = \left( \frac{\lambda}{12.6} \right) (65.41 \sin^2 \theta + 4.56 \sin \theta + 0.065)$$

$\lambda$  = slope length

$\theta$  = angle of slope in degrees

m = exponent varying with slope as follows:

S	M
1% or less	0.2
1-3%	0.3
3.5-4.5%	0.4
5% or more	0.5

(b) *Climate*: rainfall is responsible for most erosion. Splash erosion is initiated by the kinetic energy of raindrops released at the instant of impact, causing detachment of the soil particles. This energy is a function of the raindrop's characteristics: size (mass); impact velocity; and intensity. Therefore, the

rainfall factor, which is a measure of the erosion force of rainfall and run-off, is expressed in terms of E, the kinetic energy of the rainfall, where:

$$E = 916 + 331 \log I$$

E = Kinetic energy (ft. ton/acre-in)

I = Rainfall intensity (in/hr);

(c) *Characteristics of the soil:* the erodability of the soil is a function of its detachability and its transportability. Fine clay particles have low detachability and high transportability once they are separated. Silt loam has the highest erodability because it is moderately high in both detachability and transportability. In addition to soil texture, the presence of organic matter is an important element: the greater the percentage of organic matter in the soil, the lower the erodability factor. The infiltration rate of the soil is another important physical characteristic of the soil. Soils with the highest infiltration rate have lower erodability.

(d) *Vegetative cover:* vegetative cover reduces splash erosion in two ways: (i) it decreases the erosive power of the rain; and (ii) it increases the resistance of the soil surface.

## 2. Wind erosion

Wind erosion occurs mainly in arid, semi-arid and sub-humid climates. It is largely a man-made phenomenon. Wind erosion results in: (a) loss of topsoil; (b) reduction in the soil fertility; and (c) reduction in water holding capacity.

### *Wind erosion process (detachment and transportation)*

When the wind blows across a rough ground surface, friction reduces the velocity at the interface and creates turbulence. The velocity of the wind increases in proportion to the logarithm of the height within the zone of turbulence, and the velocity-height relation is shown as a straight line when it is plotted on semi-log paper. The slope of the line represents the velocity of a specific wind and is known as the drag velocity; it intercepts the Y-axis at a finite height  $h$  and represents the surface roughness. Therefore, the drag force (shear force) exerted by the wind on the surface ground is given by the expression:

$$J = \rho V^2$$

where:

J = shear force g/cm<sup>2</sup>

$\rho$  = density of air

V = drag velocity.

Table 4 shows the relation between soil texture and erodability.

### (i) *Detachment of soil particles*

There is a certain similarity between soil particles eroded by wind and those eroded by water. The uplifting force which detaches the soil particles and raises them vertically is subjected to the horizontal wind force (drag forces). It may strike well-anchored particles or heavier ones, rebound vertically and move forward by saltation. In such a case, it would jump much higher into the airstream. The descending particles may strike loose particles on the ground and transfer their momentum. These other particles detach by what is called abrasion and enter the airstream as eroding material.



(ii) *Transportation of soil*

The eroded soil particles are transported by the following means: (a) saltation and surface creep; and (b) turbulent eddy current.

Table 4. SOIL TEXTURE AND ERODABILITY CHARACTERISTICS

Soil type	Predominant soil, textural class	Dry soil aggregates >0.84 mm (%)	Soil erodability "I", mton ha/yr
1	Very fine, fine, and medium sands; dune sands	1	696
2	Loamy sands; loamy fine sands	10	301
3	Very fine sandy loams; fine sandy loams; sandy loams	25	193
4	Clays: silty clays; non-calcareous clay loams and silty clay loams with more than 35% clay content	25	193
4L	Calcareous loams and silt loams; calcareous clay loams and silty clay loams with less than 35% clay content	25	193
5	Non-calcareous loams and silty loams with less than 20% clay content; sandy clay loams; sandy clay	40	126
6	Non-calcareous loams and silty loams with more than 20% clay content; non-calcareous clay loams with less than 35% clay content	45	108
7	Silts; non-calcareous silty clay loams with less than 35% clay content	50	85

## XVI. SURFACE-WATER BODIES AND CATCHMENT CHARACTERISTICS

by

*Mohammed Shatanawi\**

### A. DATA NEEDED FOR RUN-OFF DETERMINATION

The data needed to determine run-off is the following:

- (a) Rainfall: amounts, duration, intensity;
- (b) Spatial distribution of rainfall;
- (c) Infiltration, initial storage, catchment storage;
- (d) Slope and topography;
- (e) Evaporation and evapotranspiration;
- (f) Vegetative cover;
- (g) Soil type;
- (h) Channel cross section;
- (i) Shape of the basin;
- (j) Size of the catchment:
  - (i) Hydrology: unit hydrograph;
  - (ii) Volume of run-off;
  - (iii) Time of concentration;
  - (iv) Run-off coefficient.

Run-off is that portion of precipitation that make its way toward streams, channels and lakes as surface flow. Engineers studying this are concerned with the following:

- (a) Peak rates of run-off;
- (b) Run-off volume;
- (c) Temporal distribution of run-off;
- (d) Rates and volume.

### B. CATCHMENT CHARACTERISTICS THAT AFFECT RUN-OFF

The infiltration, slope, soil type, size, geology and orientation and shape of a drainage basin determines the time of concentration, which is the time required for water to flow from the most remote (in time of flow) point to the outlet of the catchment. When the duration of a storm equals the time of concentration, all parts of the watershed are contributing simultaneously to the surface run-off at the outlet. The time of concentration can be estimated by the following equations:

(a) Kirpich equation:  
$$T_c = 0.0195 L^{0.77} S^{-0.385}$$

(b) Turazza equation:  
$$T_c = 0.108 L^{0.33} A^{0.33} S^{-0.5}$$

---

\* The author is the head of the Water and Environment Research and Study Center at the University of Jordan, Amman.

- (c) SCS method for run-off uses:  
Kirpich equation.

Run-off calculations:

$$Q = \frac{(P - I_a)^2}{(P - I_a + S)}$$

Where  $Q$  is the accumulated depth of run-off,  $P$  is the accumulated depth of storm rainfall,  $I_a$  is the depth of initial at abstraction and  $S$  is the depth of the potential abstraction.

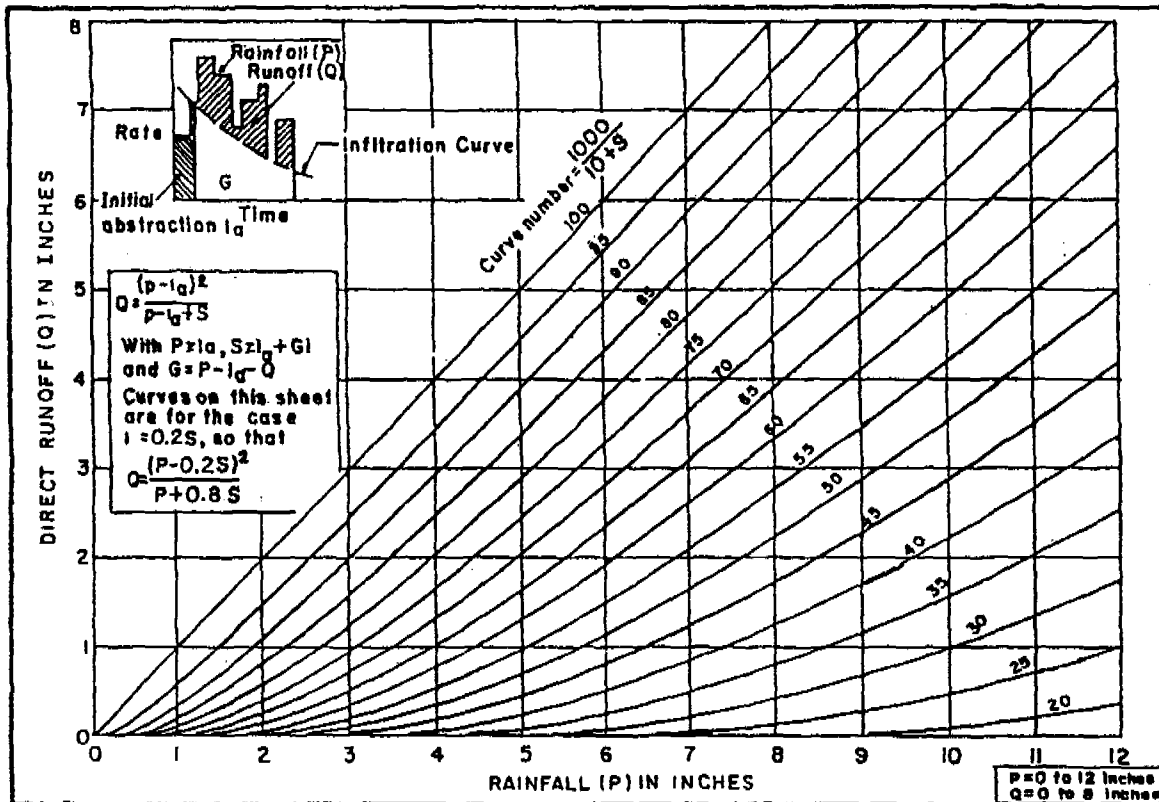
$$I_a = 0.2S$$

The relation between CN and S is:

$$S = \frac{1000 - 10}{CN}$$

Desert run-off depth can be estimated using figure I and tables 1 and 2.

Figure I. GRAPHICAL SOLUTION OF RUN-OFF EQUATION (SCS., 1969)



Source: Rugan, R.M., and T.J. Jackson, 1976. Hydrograph synthesis using Landsat remote-sensing and SCS model, Document X-913-76-161, Goddar Space Flight Centre, Guwahati, India, U.S. Department of Agriculture. Soil Conservation Services (SCS), 1969 Hydrology Guide for Use in Watershed Planning, National Engineering Handbook, series 4. Beltsville, Md.

TABLE 1. HYDROLOGIC GROUPING OF SOIL TEXTURES SELECTED FROM HYDROLOGIC SOIL GROUPINGS FROM THE AZRAQ BASIN

Hydrologic soil grouping	Soil textures
A	sand, loamy, and sandy loam
B	silt loam and loam
C	sandy clay loam
D	clay loam, silty clay loam, sandy clay, silty clay and clay

TABLE 2. RUN-OFF CURVE NUMBERS FOR LAND COVER DELINEATIONS DEFINED FROM LANDSAT INVESTIGATIONS

Land use description	Hydrologic soil group			
	A	B	C	D
Forest land	25	55	70	77
Grassed open space	36	60	73	78
Highly impervious (commercial, industrial, large parking lot) <sup>a/</sup>	90	93	94	95
Residential	60	74	83	87
Bare ground	72	82	88	90

a/ According to Ragan and Jackson (1976), CN = 93, which is probably sufficient for all soils.

### 1. Peak flow measurement

In the United States of America and the United Kingdom of Great Britain and Northern Ireland, they develop envelope curves for each area, and empirical formulas have been established relating peak discharge to the other influencing factors, based on the following equation:

$$Q_p = f(t_p, d_p, A, t_r)$$

Flood hydrograph is used to determine a total volume of run-off using the following:

- (a) Measurement stage recorder;
- (b) Unit hydrograph, which is a characteristic of the catchment.

### 2. Infiltration measurement

The infiltration rate is influenced by soil texture and degree of saturation, vegetation cover and slope. The infiltration rate can be estimated using double-ring infiltrometers and rainfall simulators.

### 3. Slope

Slope affects:

- (a) Time of concentration;

- (b) Infiltration;
- (c) Sediment transport.

#### 4. Area

Area is reflected by length of the reach. It affects:

- (a) Time of concentration;
- (b) Volume of run-off;
- (c) Peak run-off.

#### 5. Channel cross-section

##### (a) Run-off modelling

###### (i) Hydrological modelling

Hec-1: A computer programme model simulates the surface run-off response of a river basin to precipitation by representing the basin as an interconnected system of hydrologic and hydraulic components. Each component models an aspect of the precipitation run-off process within a portion of the basin commonly referred to as a sub-basin. A component may represent a surface run-off entity, a stream channel or a reservoir.

###### (ii) Components of the model

The run-off model may consist of the following components:

- a. Stream networks model development: a schematic diagram of a basin can be developed by taking the following steps (see figure II):
  - i. The study area watershed boundary is delineated first;
  - ii. Segmentation of the basin into a number of sub-basins determines the numbers and types of stream network components to be used in the model;
  - iii. Each sub-basin is to be represented by a combination of model components;
  - iv. The sub-basins and their components are linked together to represent the connectivity of the river basin;
- b. Land surface run-off component;
- c. River routing component;
- d. Combined use of river routing and sub-basin run-off components;
- e. Reservoir component;
- f. Diversion component;

- g. Pump component;
- h. Hydrograph transformation;

(ii) *Infiltration model*

This programme provides a systematic approach to estimating the infiltration capacity of storm water during and following the storm. The infiltration ( $I$ ) of the transmissive zone using Darcy's law is expressed as follows:

$$I = \frac{K(H + L - h)}{L}$$

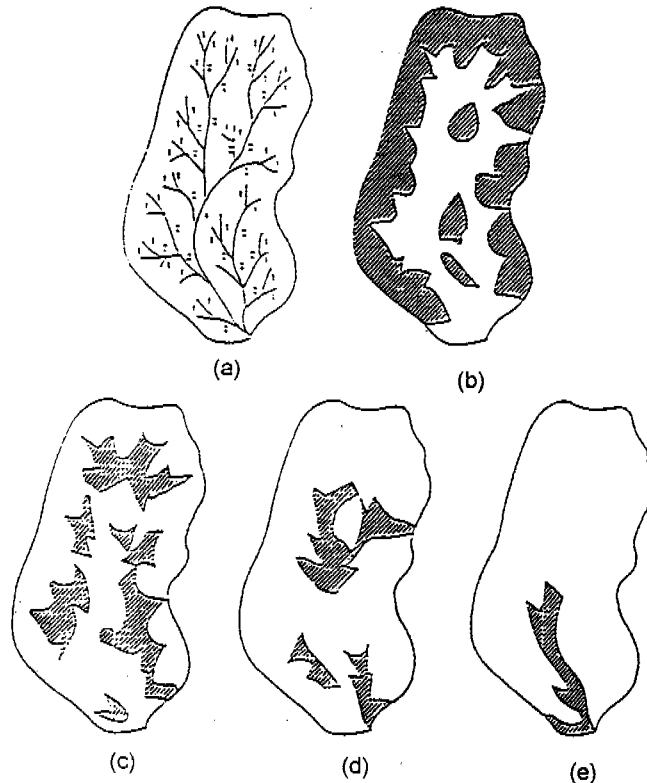
Where  $I$  is the infiltration,  $K$  is unsaturated vertical hydraulic conductivity,  $H$  is the depth of ponded water,  $h$  is the capillary suction potential at the wetting front, and  $L$  is the depth of penetration of the wetting front.

The time since infiltration started is calculated as follows:

$$t = \left( \frac{f}{K} \right) \left( L - (H - h) \ln \left[ \frac{(H + L - h)}{H - h} \right] \right)$$

Where  $t$  is the time and  $f$  is the effective storage coefficient.

**Figure II. Drainage network character: delineation of stream areas for (a) first order, (b) second order, (c) third order, (d) fourth order, and (e) the stream's main channel**



## References

- Regan, R.M. and T.J Jackson, 1976. Hydrograph Synthesis Using Landsat remote-sensing and SCS model, Document X-913-76-161, Goddar SPACE Flight Center, Guwahati, India.
- U.S. Department of Agriculture. Soil Conservation Services (SCS), 1969. Hydrology Guide for use in Watershed Planning, National Engineering Handbook, Series 4. Beltsville, Md.

## XVII. SHARED SURFACE WATER IN THE ESCWA REGION

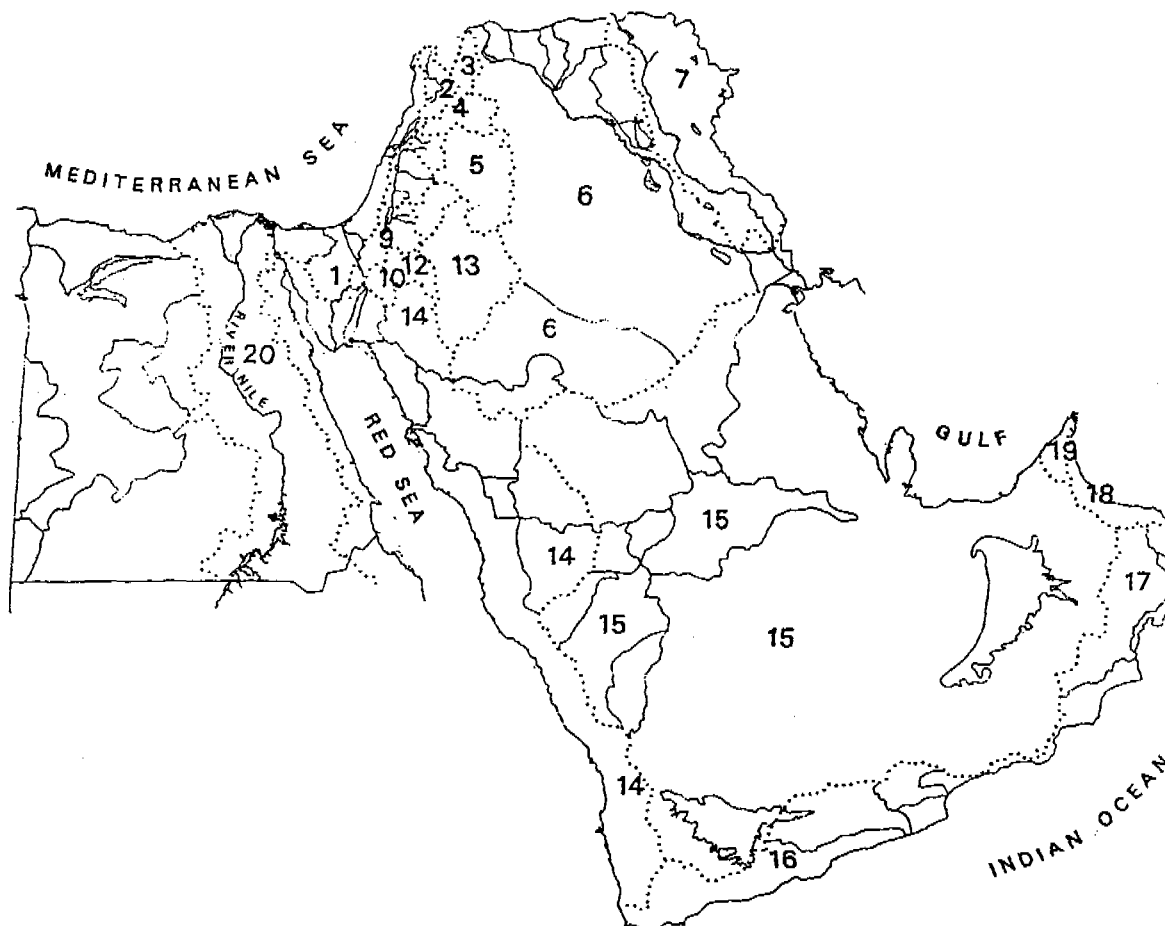
by

*Mohamed El-Sallag\**

### Introduction

Twenty main hydrological basins are recognized in the Middle East region, some of them divided into smaller hydrological units (figure I). The digitalized world map (scale 1:1,000,000) and remote-sensing software (Arc/Info) at the Royal Jordanian Geographic Centre was used to delineate these major surface water units or basins on a regional basis. The surface water divides/boundaries are usually well defined, as is the case with the Nile, Tigris, Euphrates, Jordan and Orontes rivers, which are shared by riparian States. The major river basins are covered in some detail in the present study, in the light of their vital importance in regional socio-economic development.

**Figure I. Surface water basins in the ESCWA region  
(scale = 1:18,000,000)**



*The boundaries and names shown and the designations used on this map do not imply official endorsement or acceptance by the United Nations.*

\* The author is a consultant in hydrology for the Ministry of Water and Irrigation, Amman.



## A. THE EUPHRATES RIVER

*Headwaters.* Furat sou and Murat sou, headwaters of the Euphrates River, rise to an altitude of about 3,000 metres in the Turkish highlands (Taurus mountains).

*Drainage area:* The drainage area is 444,000 km<sup>2</sup> (ESCWA, 1981), and the length is 2,330 km (Khouri, 1991). However, according to new measurements, the drainage area within the Arab region alone is 628,900 km<sup>2</sup> (see figure II).

*Precipitation:* The catchment upstream from Kiban has an area of 6,400 km<sup>2</sup> (16). More than 50% of this area rises to altitudes exceeding 1,600 metres. Average annual precipitation in the headwaters area ranges from 500 mm to 900 mm, and most of the precipitation occurs as snow in winter. Precipitation decreases to 300-450 mm in southern Turkey and the north-eastern Syrian Arab Republic in the catchment area of Khabour, the main tributary to the Euphrates River. In the steppe areas lying to the south of the Euphrates River, the catchment areas of ephemeral streams receive an average of about 150-200 mm. Run-off occurs mainly after intense rainstorms or thundershowers in the fall or spring. Gentle rains in winter rarely cause run-off (Khouri, 1991).

*Stream characteristics:* To the south of the point of confluence of its headwater tributaries, near Kiban, the river flows for 120 km through a canyon until it is joined by its third tributary, Tohma sou, which originates in the Taurus mountains. The Euphrates crosses the Syrian-Turkish border at Tarablous. Its northern tributaries, the Khabour and Belikh, which drain the Jezira, are perennial, whereas the tributaries or wadis which drain the Syrian desert are ephemeral. Wadi watersheds extend into the Hamad Plateau in the Syrian Arab Republic, Iraq, Jordan and Saudi Arabia.

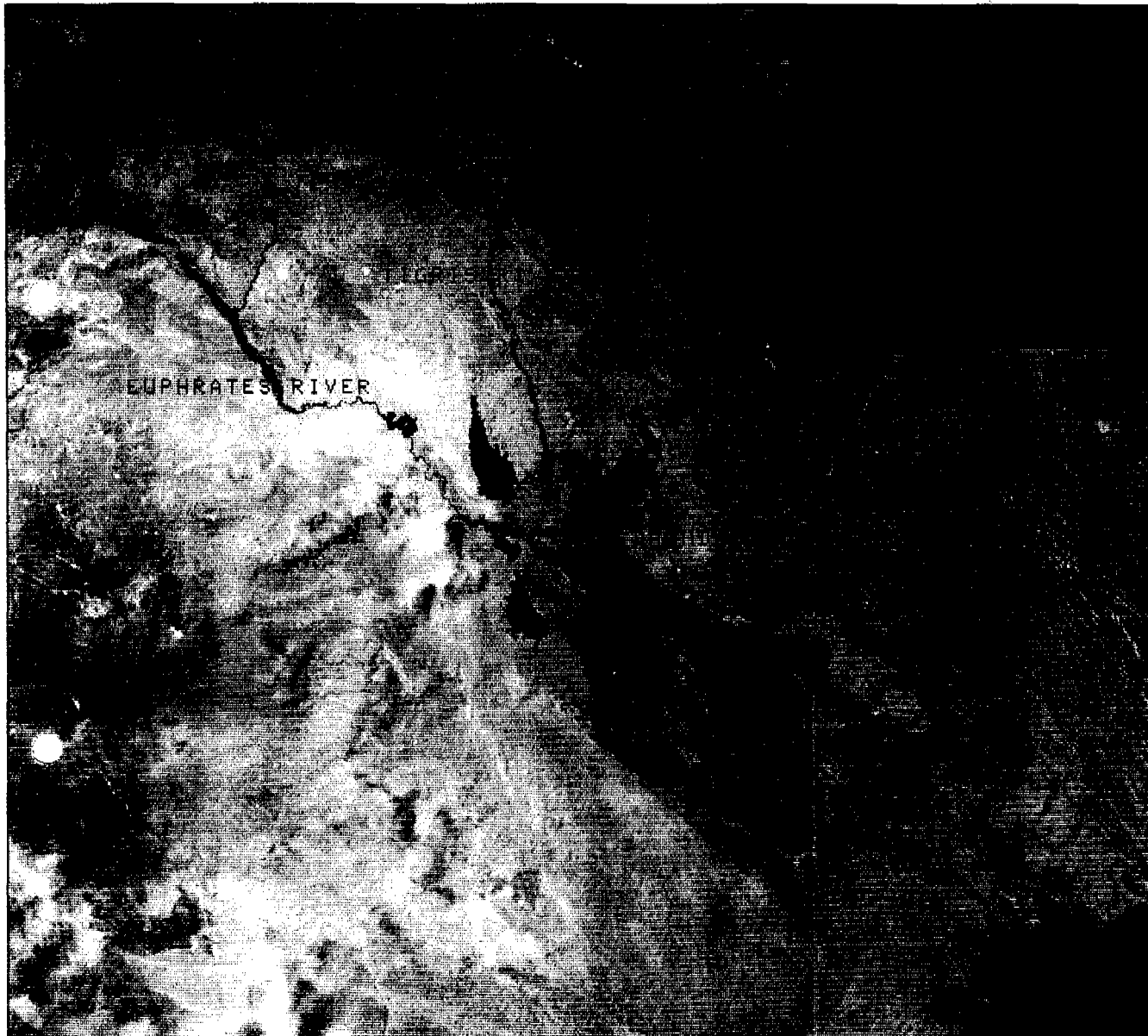
*Stream flow:* Average annual natural run-off of the Euphrates is estimated at 31.83 billion cubic metres (BCM). The average annual flow in the Syrian Arab Republic is about 268 BCM. Discharge at El-Thoura is 850 m<sup>3</sup>/s. During the period from 1924 to 1973, the maximum discharge recorded was 6,720 m<sup>3</sup>/s, and the minimum discharge was 142 m<sup>3</sup>/s (Khouri, 1991).

The Euphrates River has been regulated by several dams, the largest of which are the Kiban Dam (capacity: 30.6 BCM) and the Al-Thoura Dam (capacity: 11.6 BCM). The average annual yield of the watershed above the Kiban Dam is 19.4 BCM, and downstream from the Kiban Dam it is 7.4 BCM. The main source of water for the latter flow is rainfall, while snow contributes considerably to the former's upper watershed run-off. Perennial tributary streams are the Sajour, Belikh and Khabour. The Sajour's average flow is about 4 m<sup>3</sup>/s. The flow is completely consumed for irrigation in summer. The Belikh River has an average annual flow of about 150 million cubic metres (MCM) (Khouri, 1991). The Khabour is the largest tributary in the Syrian Arab Republic, its annual flow being about 1.5 BCM and its average discharge being 50 m<sup>3</sup>/s. The maximum discharge during the period of record was 386 m<sup>3</sup>/s (Khouri, 1991).

*Water quality:* Published information on the quality of Euphrates waters is limited. General remarks and information published in 1980 (Khouri, 1991) indicate wide variations from season to season and along the course of the river from the headwaters to the mouth. Factors affecting water quality in the middle and lower reaches in the Syrian Arab Republic and Iraq are groundwater inflow and seepage from the Lower Fars gypsum aquifer and return flow from the drainage systems. In general, the specific conductance varies inversely with flow of the Euphrates River. In Iraq, for example, the average values of conductivity vary from 600 microhms/cm at Heet to 976 at Nasrieh (Khouri, 1991). The specific conductance increase during periods of low stream flow at Heet is 776 microhms and decreases during high flow to 470 microhms/cm. The water quality variations observed in the lower reaches exist in other, higher reaches in the Syrian Arab Republic and even in Turkey. Geology, evaporite deposits and drainage are among other factors influencing

water mineralization. Marshes and wetlands such as Al-Ahwaz also contribute to the increase in the dissolved-solids content of the river.

**Figure II. The drainage area within the Arab region**



*The boundaries and names shown and the designations used on this map do not imply official endorsement or acceptance by the United Nations.*

*Regulation:* Several water-supply, irrigation and hydroelectric projects have been implemented in the last two decades. Some dams are multi-purpose. The largest reservoir, the Ataturk Dam (capacity: 49 BCM), is under construction. The second largest is Kiban (capacity: 30.6 BCM). The dams that are being constructed in the Syrian Arab Republic and Iraq at Al-Thoura and Haditheh are smaller in size, with capacities of about 11 BCM. A smaller dam has been constructed downstream from Al-Thoura to regulate the flow released from the Al-Thoura Dam. A temporary arrangement has been made between the concerned States for the management of the Euphrates basin, but the situation will be further complicated after the completion of the Ataturk Dam and other projects now under implementation in Turkey. A more integrated and rational management of the shared resources is urgently needed.

## B. THE TIGRIS RIVER

*Headwaters:* The Tigris River rises from the eastern Taurus Mountains at an altitude ranging between 1,000 and 1,500 metres. As the river flows southwards through Diyar Bakir, it turns eastwards, where it is joined by three headwater tributaries: the Butman River, with its headwaters fairly high in the mountain ranges (3,000 m), the Kazran-Jay, and another tributary which rises near the Iraq-Turkish border.

*Drainage area:* The Tigris drainage area is estimated at 471,606 km<sup>2</sup> distributed over three countries, as follows: (Khouri, 1991; ESCWA, 1981):

<u>Country</u>	<u>km<sup>2</sup></u>
Iraq	253 000
Turkey	57 614
Syrian Arab Republic	834
<u>Iran (Islamic Republic of)</u>	<u>16 015</u>
TOTAL	327 463

However, the new measurement within the ESCWA region is 146,239 km<sup>2</sup>, which is significantly smaller than the figure mentioned above.

*Precipitation:* Mean annual rainfall over the catchment area is about 800 mm. Annual precipitation ranges from 440 to 1,600 mm. Snowfall on lower mountains and hills (1,000-2,000 metres) contributes to floods that occur in late winter when the temperature starts to rise. The snow cover on the higher catchment area (2,500-4,500 metres) is the main source of water for spring run-off. Limitations with regard to data availability make it difficult to estimate the contribution of snow cover to surface run-off.

*Stream characteristics:* After the Tigris River is joined by its headwaters tributaries, it forms the border between Turkey and the north-eastern Syrian Arab Republic, and it crosses the border into Iraq (see figure II). In Iraq, eight main tributaries and several smaller ones join the river, namely the Great Zab, the Little Zab, Al-Adheim, Diyala, Taiyb, Dweirij, Korkha and Karoun. At Samurah, larger floods are diverted into the Tharthar Canal, which empties into the Tharthar depression. The river flows southward and joins the second branch of the Euphrates at Karmeh-Ali, located about 10 km north of Basra, forming the Shat El-Arab channel, which is about 110 km long and between 600 and 2,000 metres wide.

## *Tigris tributaries*

### (a) *The Great Zab River*

This is the largest tributary of the Tigris River. Its headwaters originate from the Ararat Mountains rising to an altitude of 4,636 metres above sea level. The total catchment area of this tributary is 25,810 km<sup>2</sup>, of which 16,000 km<sup>2</sup> is in Iraq (Khouri, 1991). The river is 392 km long and joins the Tigris south of the town of Musel. The average annual stream flow is estimated at 13.18 km<sup>3</sup>. The maximum recorded discharge is about 10,570 m<sup>3</sup>/s, and the minimum flow is around 67 m<sup>3</sup>/s (ESCWA, 1981).

### (b) *The Little Zab River*

The headwaters of the Little Zab River are located at the border zone between Iraq and the Islamic Republic of Iran. The drainage area is estimated at 21,475 km<sup>2</sup> (15,975 km<sup>2</sup> of which is located in Iraqi territory). The river is 400 km long and it joins the Tigris river north of Fatha (Khouri, 1991). The average annual river discharge is 7.17 km<sup>3</sup>; maximum and minimum volumes are 17.01 km<sup>3</sup> and 3.02 km<sup>3</sup> respectively. The recorded maximum discharge was 3,420 m<sup>3</sup>/s. The annual safe-yield after construction of the Dokan dam (capacity: 6.8 km<sup>3</sup>) is about 5.07 km<sup>3</sup> (ESCWA, 1981).

### (c) *The Al-Adheim River*

The headwaters of the Al-Adheim River rise at Kura Dagh and the Shwam highlands and drain an area of about 13,000 km<sup>2</sup> which lies entirely within Iraqi territory. The length of the river is 330 km (ESCWA, 1981). The average annual discharge is 0.79 km<sup>3</sup>. The maximum and minimum annual discharge is 1.85 km<sup>3</sup> and 0.18 km<sup>3</sup> respectively (ESCWA, 1981). Al-Adheim River is an intermittent stream that is subject to flash floods reaching up to 13,000 m<sup>3</sup>/s (ESCWA, 1981). The flow usually ends during the period June to October.

### (d) *The Diyala River*

The headwaters of the Diyala River (386 km long) are located in the Islamic Republic of Iran. This river drains an area of about 31,896 km<sup>2</sup>, of which 24,072 km<sup>2</sup> is in Iraqi territory (Khouri, 1991). The principal tributaries of the river are the Seirawan and the Tangro. The annual minimum, maximum and mean flows are 2.44 km<sup>3</sup>, 14.27 km<sup>3</sup> and 5.74 km<sup>3</sup> respectively. The flow has been regulated through the construction of two dams: the Derbandani Khan Dam (3 km<sup>3</sup>) and the Hemin Dam (3.95 km<sup>3</sup>).

### (e) *The Taiyb River*

The Taiyb River originates in the Zagros Ranges and drains an area of about 5,000 km<sup>2</sup> (ESCWA, 1981). The average annual discharge is about 1 km<sup>3</sup>. The length of the river is 80 km.

### (f) *The Dweirij River*

This river rises in the Zagros Mountains. Its length is about 110 km and its basin area covers about 3,000 km<sup>2</sup> (ESCWA, 1981).

(g) *The Korkha River*

The river heads along the southern flanks of the Zagros Mountains in the Islamic Republic of Iran. The Korkha River drainage basin area is about 46,000 km<sup>2</sup>, and its average annual flow is about 6.3 km<sup>3</sup>. It empties into Hor Hweiziya (ESCWA, 1981).

(h) *The Karoun River*

The headwaters of this river rise at the Zagros Mountains in the Islamic Republic of Iran. The drainage basin area is about 58,100 km<sup>2</sup>, and the average annual discharge is 24.7 km<sup>3</sup> at Ahwaz (ESCWA, 1981). The river joins the Shat el-Arab south of Basra. The length of the river is 630 km, and its freshwater improves the quality of the Shat el-Arab's waters.

The Shat el-Arab River is formed by the merging of the Tigris and Euphrates rivers at El-Qurna. Thus, the total catchment area is about 808,000 km<sup>2</sup>, its length is 110 km, and the width of its channel ranges between 600 and 2,000 metres (ESCWA, 1981). The mean annual flow is about 21 km<sup>3</sup> at Basra but reaches 35.2 km<sup>3</sup> at Al-Fao. The lower end of the river empties into the Gulf.

*Stream flow:* The average annual flow of the Tigris River is estimated at 50 MCM (Khouri, 1991). The minimum flow measured in 1930 was 19 BCM, and it reached 106 BCM in 1969. At Musel, the maximum recorded flow was 7,539 m<sup>3</sup>/s, and the minimum flow was 88 m<sup>3</sup>/s (ESCWA, 1981). Statistical analysis has indicated a probable maximum flood of about 30,000 m<sup>3</sup>/s (ESCWA, 1981). The average discharge of the Tigris River at Musel is about 650 m<sup>3</sup>/s (Khouri, 1991). The discharge increases considerably between Musel and Baghdad after the river is joined by the main tributaries (Great Zab, Little Zab and Al-Adheim). The river discharge decreases south of Baghdad because of higher evaporation and diversion for irrigation purposes or to depressions, lakes and reservoirs. The average discharge of the Al-Amarah is about 152 m<sup>3</sup>/s. The high losses in the lower reaches is due to infiltration, evaporation and diversion to irrigation projects and to the Gharaf, Dujeileh canal and Musandak canal, leading to extensive marshes and Ahwaz.

The stream flow characteristics of the Tigris and Euphrates rivers at different measurement points throughout Iraq are shown in table 1.

*Water quality.* The dissolved-solids content for the principal Tigris tributaries (Greater Zab, Diyala, Little Zab) is low, ranging from 250 PPM to 500 PPM (Khouri, 1991; ESCWA, 1981). Generally, the chemical quality of the water of the Tigris River and its tributaries varies with the magnitude of discharge as well as with the geology and soils of the drainage area. The dissolved-solids content of the Tigris River shows considerable seasonal variation. At Ninewah the dissolved-solids content ranges from 225 PPM in summer to about 425 PPM in winter. In the upper reaches, near Musel, the specific conductance of the water is 404 microhms, whereas it increases in the lower reaches, at Kurneh, to 880 microhms (Khouri, 1991). The chemical quality of the main stream is influenced by the quality of the water from its tributaries. Between Musel and Samurra, the specific conductance of the Tigris River waters decreases by about 370 microhms as a result of dilution from the higher quality water of the Great Zab and the Little Zab. However, the specific conductance increases to about 440 microhms near Baghdad and to 770 in the lower reaches near Kurnah (Khouri, 1991). This increase in salinity is due to mixing with the inflowing waters from the Al-Adheim and Diyala rivers (the TDS of the latter is about 440 PPM). Drainage water discharging into the river from Al Khaled (4,200 PPM) and Saqlanieh (1,200 PPM) and Taiyb (4,400 PPM) (Khouri, 1991) raise the dissolved-solids content of the Tigris to a level that could not be compensated for by the contribution of good water from the smaller tributaries in the middle and lower reaches.

One of the main dangers in the basins of the Tigris and the Euphrates rivers is salinization, a phenomenon which affects soil, groundwater and surface water. The chemical quality of the water in both basins is closely related. Thus, during periods of high flow, the dissolved-solids content of the river and of most groundwater in the shallow deposits adjacent to the river decreases markedly. However, the dissolved-solids content of the groundwater increases in certain areas during these same periods because the water table rises into highly saline, silty and clay-like flood plain deposits. Soil salinity in Iraq is particularly pronounced in the central and southern parts of the Mesopotamian plain because of high evaporation and land irrigation with insufficient drainage.

Table 1. AVERAGE DISCHARGE AT VARIOUS REACHES OF THE EUPHRATES AND TIGRIS RIVERS IN IRAQ (GAINS AND LOSSES)

River section	Flood flow (December-March) run-off from rainfall (m <sup>2</sup> /sec.)	Flood flow (April-July) snowmelt & rainfall (m <sup>2</sup> /sec.)	Base flow (August-October) (m <sup>2</sup> /sec.)
<i>Euphrates</i>			
Gauging station			
1. Heet	808	1 642	343
2. Al-Himdyeh	538	1 135	210
3. Al-Sannafyeh	498	848	167
4. Al-Nasseryeh	406	787	172
<i>Tigris</i>			
1. Tassan	630	890	253
2. Al-Mosul	717	903	272
3. Al-Fohhah	1 404	2 169	458
4. Sannurah	1 134	1 524	492
5. Baghdad	1 210	1 864	373
6. Al-Kout	1 046	1 462	292
7. Al-Amarat	162	235	82
8. Qalaot Saler	48	72	26
<i>Great Zab</i>			
1. Bakhmeh	322	735	148
2. Esky Balh	372	728	150
<i>Little Zab</i>			
1. Dokan	256	208	136
2. Alton Kubry	302	247	137
<i>Al-Adheim</i>			
1. Antanah	52	141	117
<i>Diyala</i>			
1. Derbandi Khan	179	169	107

Source: J. Khouri, "Hydrology and hydrogeology of major basins and aquifer systems in the Mashrek, Arabian Peninsula and Nile Valley (Damascus, ACSAD, 1991).

During periods of low stream flow in the late summer and fall, the chemical quality of the river water reflects that of the under-flow from tributaries, and from groundwater. Downstream, the water quality depends mainly on the interchange between the rivers and the groundwater reservoirs. The quality of the water of the Shat el-Arab depends essentially on the chemical quality of the Tigris River, Euphrates River

and the Karoun tributary. The concentration of dissolved-solids also increases as a result of seepage gains from groundwater. There is sea-water intrusion, especially in the lower reaches, which is influenced by total movements. The specific conductance in the waters of the Shat el-Arab increases rapidly in the downstream direction from 900 microhms at Kurnah to about 300 microhms at Al-Fao (Khouri, 1991).

*Regulation:* Several major storage facilities and diversion structures have been constructed on the Tigris River and its main tributaries. Larger hydraulic projects have been established for multiple purposes (basically for flood control, irrigation and hydroelectric power). Major structures constructed on the main stream of the Tigris River are the Dokan Dam, the Tharthar, Samurrah, Al-Ramadi and Al-Warar. All these structures serve to regulate and control flow of the Tigris River. They have paved the way for the construction of large irrigation projects, including an integrated irrigation-drainage system designed and implemented to expand and improve irrigated agriculture and control salinity. In this context, the Tigris-Euphrates main outfall drain, once completed, will receive drainage water from the majority of the irrigation projects and will markedly improve the quality of the surface water in the flood plain. Together with main outfall drain, such drains as the East Euphrates drain, the lower Diyala drain and Shat El-Arab drains constitute an integrated drainage system for the control of salinity and the waterlogging problem in the great Tigris-Euphrates basins. Important irrigation projects include the Saddam irrigation project, the Gezira irrigation project, the Abu Ghreib irrigation project, and the Hileh-Kafel irrigation project. The total area irrigated through these projects is 3,600,000 Iraqi dunums.

Among the most important hydraulic projects implemented in connection with the Tigris and Euphrates rivers and their tributaries are the Kiban dam in Turkey (completed, with a capacity of 31 BCM); the Kara kaya (completed, with a capacity of 9.6 BCM); and the Al-Thoura in the Syrian Arab Republic (completed, with a capacity of 11.6 BCM); those currently under construction include three large dams on the Tigris River in Turkey and the Ataturk Dam on the Euphrates (capacity: 4.9 BCM) (Khouri, 1991). Whereas the construction of development projects is essential to the improvement of the quality of life in the shared Euphrates and Tigris basins, it is equally essential to ensure that the man-made structures which have been built and the development projects which have been implemented do not have an adverse environmental impact. Such an impact would threaten the continuity and sustainability of development, which depend on integrated and rational management of shared surface-water resources, which in turn depends on cooperation and agreements between the countries concerned.

### C. THE ORONTES BASIN

*Source:* The Orontes River originates in Lebanon, in the northern Beka'a valley at the Al-Labweh Spring near Baalbeck, at an elevation of 400 metres.

*Drainage area:* The River has a drainage area of 21,600 km<sup>2</sup> and is 487 km long (Khouri, 1991). Most of the drainage area (15,866 km<sup>2</sup>) is located within the Arab region.

*Precipitation:* The Orontes River and its tributaries drain highlands and plateau areas situated on both sides of the Rift Valley. The western mountains receive annual precipitation ranging from 600 mm to 1,500 mm. Snowfall in the coastal mountains of Lebanon and the Syrian Arab Republic contributes to stream flow either directly or indirectly through subterranean drainage or groundwater flow via large karstic springs located at the flanks or at the base of the Alouite and Lebanon carbonate massif. Annual precipitation on the eastern catchments is much lower, ranging from 400 mm to 600 mm. Consequently, the eastern tributaries are characterized by ephemeral flows.

*Stream characteristics:* Before the River enters the Syrian Arab Republic near Hermel, the flow increases considerably as water from Ain Lerka (11 m<sup>3</sup>/s) (Khouri, 1991) and other springs (4 m<sup>3</sup>/s)

discharges into the River. The River is fed mainly fed by groundwater (90% of the total flow), the recharge of which depends on the thickness of the snow cover and the regime of snow melting on the Hermel Mountains. Shortly after reaching the Syrian Arab Republic, it enters the Qattineh reservoir, where it is fed by several springs, the largest of which is Ain Tannur (1.5 m<sup>3</sup>/s). Downstream from Qattineh, the valley is shallow with a gentle slope. Downstream from Rastan, the River flows into a canyon 100-150 metres deep. It leaves the canyon near Shezar and flows into the Asharneh Valley and then into the 40-km Ghab depression. At this point, the River is canalized. However, the insufficient carrying capacity of the canals causes frequent overflows during floods. After leaving the Ghab, the River enters into a canyon and flows into Iskendaron Province as a mountain river. The right bank tributaries of Rabia, Qafat and Daura show seasonal flow variations; the Meidan River does not. The left bank tributaries are the Nafseh, Sarout, Salkhab and Abiad Rivers. Several large springs discharge into the River, particularly in the Ghab depression. An important tributary is the Afrin River, which originates on the southern slopes of Tavz Mountains; the River's watershed extends over the Kurd Dash mountains, which is characterized by a deep valley and steep slopes.

*Stream flow:* The average annual flow of the Orontes River is estimated at 2,400 MCM (Khouri, 1991). Minimum and maximum daily discharge is 10 m<sup>3</sup>/s and 400 m<sup>3</sup>/s respectively. The mean annual discharge increases steadily in the upper and middle reaches, but rises sharply in the lower reaches owing to sizeable contributions from a large number of springs (see tables 2 and 3).

TABLE 2. GAUGING STATIONS AND DISCHARGE RATES ALONG THE ORONTES BASIN

Measurement sites	Catchment area (km <sup>2</sup> )	Mean annual discharge (Q m <sup>3</sup> /s)
Qusseir	1 690	16.1
Qattineh	3 990	19.6
Raestan	4 820	26.1
Mhardeh	12 660	36.1
Jisr-Shughur	1 513	60.8
Dergush	15 540	75.5

TABLE 3. SPRINGS DISCHARGING INTO THE ORONTES RIVER

Reach	Number of springs	Total discharge (m <sup>3</sup> /s)
Headwaters springs (Lebanon)	3	13.11
Upper reach	4	2.25
Hama-Mhardeh	7	0.45
Chizer spring	1	6.42
Achorreh	6	2.27
West Ghab	19	0.9
East Ghab	10	7.59
Lower reach	4	2.24
<b>Total</b>		<b>38.23=1,200 MCM</b>

Source: J. Khouri, "Hydrology and hydrogeology of major basins and aquifer systems in the Mashrek, Arabian Peninsula and Nile Valley (Damascus, ACSAD, 1991).



It can be readily seen from table 3 that about 50% of the annual flow of the Orontes River comes from springs discharging along carbonate massifs in Lebanon and the Syrian Arab Republic, thus reflecting the karstic nature of the limestone terrain. It should be emphasized, however, that the water of several springs is partly or totally utilized directly before it reaches the River channel. Thus, the average annual flow crossing the border from Lebanon is about 90 MCM or approximately 3 m<sup>3</sup>/s (Khouri, 1991).

*Water quality:* The quality of water from the Orontes varies from its source to its mouth. Total dissolved solids (TDS) at Qattineh ranges from 190 to 240 ppm. In the middle reach water mineralization reaches 500 ppm and at the lower reach near it varies from 400 to 930 ppm (Khouri, 1991).

Pollution levels have increased considerably in the middle and lower reaches of the River, as well as in the Qattineh, Raestan and Mhardeh storage reservoirs. The eutrophication process occurs where the presence of nutrients leads to the excessive growth of algae. The discharge of untreated water from along the River makes the water unsuitable for domestic purposes (Khouri, 1991).

*Regulation:* The Qattineh reservoir (capacity 200 MCM), Raestan reservoir (225 MCM) and Mhardeh (50 MCM) regulate water flow and generate electricity. The water of the Orontes is intensively used for irrigation, water supply and industry. The main canal of the Homs-Hama irrigation system covers about 23,000 hectares, with water supply from the Qattineh reservoir.

Mhardeh reservoir supplies water to Asharneh plain, while the Raestan reservoir supplies water to the irrigated lands of Asharneh and Al-Ghab.

Recent water resources developments carried out in the Ghab area comprise the construction of three dams:

Afamia	Capacity 92 MCM
Qastoun	Capacity 26 MCM
Zeizoun	Capacity 68 MCM

#### D. JORDAN RIVER BASIN

*Source:* The Dan, Baniyas and Hasbani rivers form the headwaters of the Jordan River. The point of confluence of the headwaters of these tributaries is about 4 km of the northern border of the occupied territories. It lies at an altitude of 90 metres above sea level. The Dan river first joins the Baniyas river, and their combined channel joins the Hasbani river 1.5 km from their point of confluence. The Hasbani river rises at an altitude of about 900 metres.

*Drainage area:* The Jordan River has a drainage area of 18,114 km<sup>2</sup> and is 225 km long (Khouri, 1991); more recent estimates give the drainage area as 18,577 km<sup>2</sup>.

*Precipitation:* Annual precipitation at high elevations range from 800 to 1,600 mm. Snowfall contributes about 25% of the annual yield of the upper Jordan basin. Precipitation on the Yarmouk basin and other lower catchments ranges between 250 and 600 mm.

*Stream characteristics and stream flow:* downstream from the point of confluence of the headwater tributaries, the width of the principal channel of the Jordan River is about 150 m (Khouri, 1991). The Houleh Lake previously occupied an area of about 14 km<sup>2</sup>, with the depth of its freshwater lenses ranging from 2 to 5 metres. The lake and the marshes (the northern area of the lake) were drained in 1958 for the excavation of three drainage canals (the northern, eastern and western canals). After emerging from the

Houleh Lake area, the river flows through a narrow, deep basaltic gorge over a distance of about 12 km (Khouri, 1991). The channel widens as the River enters the Buteiha alluvial plain. The major catchment of the River is Lake Tiberias.

Lake Tiberias occupies an area of about 165 km<sup>2</sup> and has a storage capacity of about 3,000 MCM. Withdrawal from the lake amounts to 400 MCM (Khouri, 1991). The dissolved solid (TDS) content of the Jordan River increases with the flow (40 MCM per year) from the saline springs around Lake Tiberias. TDS values drop in winter as a result of dilution with a relatively large volume of surface inflow. After emerging from Lake Tiberias, the Jordan River has an average width of about 25 m and a depth of about 2-3 metres. In its lower reaches, a large number of tributaries join the principal stream from west and east. These tributaries drain mountainous or hilly terrain composed mainly of carbonate rocks. Major tributaries are the Yarmouk and Zarqa rivers; the rest are large or small wadi-basins, mainly ephemeral or with a small base flow. The Jordan River empties into the Dead Sea, its course is straight as the river flows for about 5 km, cutting its channel in delta alluvial deposits. The average annual discharge at its mouth is about 875 MCM. Maximum and minimum annual flow is 1,650 MCM (1942-1943) and 648 MCM (1933-1934) respectively. The flow of the River in the early 1950s reflected its natural flow regime, estimated as follows (Khouri, 1991):

Average annual flow from all tributaries	1,880 MCM
Total evaporation losses	630 MCM
Average discharge at mouth	<u>1,255 MCM</u>

#### *Major tributaries*

(a) *The Dan River*

The Dan River has its source at Tel El-Qadi in the occupied territory near the Syrian border. It flows through a narrow canyon for about 8 km from its source to its point of confluence with the Banias River at an altitude of 43 metres. The river channel is characterized by a steppe gradient (it falls 2 m in 1 km). The average annual stream flow during 1950-1975 was estimated at 240 MCM (Khouri, 1991). Recent estimates put the annual average flow at about 260 MCM. The maximum yearly discharge for the same period was 285 MCM (in 1949-1950). The minimum annual flow was 217 MCM (1961-1962). The river discharge is noted for its minor flow variations throughout the year.

(b) *The Banias River*

The source of the Banias River originates near the foot of Mount Hermon at an altitude of 329 metres in the occupied Syrian territory. The river flows through a gorge for 9 km. The stream has a steep gradient of about 5 metres per kilometre. Discharge is variable, and the annual average yield was 120 MCM for the period 1950-1975 (Khouri, 1991). The main discharges come from karstic springs. The run-off amount is about 20%. Daily stream flow ranged from a maximum of 16 m<sup>3</sup>/s in winter to a minimum of 2 m<sup>3</sup>/s in the dry season. Stream flow is characterized by high seasonal and yearly variations. The maximum total stream flow in a water year for the period 1950-1975 was about 148 MCM in 1944-1945, and the minimum total stream flow in a water year was about 81 MCM (1960-1961) (97 in Khouri, 1991).

(c) *The Hasbani River*

*Source:* The Hasbani River runs along the north-western flanks of Mount Hermon in Lebanon at an altitude of about 900 metres. It flows through a narrow gorge and in a rough basaltic terrain. The river is

ephemeral in its upper reaches and becomes perennial near the town of Hasbaiya. Before it crosses the border, several springs discharge into its channel, the largest of which is the Wazan Spring. The discharge of the Hasbani River ranges from 20 m<sup>3</sup>/s in the wet season to 1.4 m<sup>3</sup>/s in the dry season. The average annual stream flow of the Hasbani River during the period 1950-1975 was 153 MCM (Khouri, 1991). The yearly maximum was about 635 MCM in 1960-1961 (Khouri, 1991). The Hasbani River is joined by its tributary, the Bright River (average annual discharge: 5 MCM) before joining the Dan and Banias rivers (Khouri, 1991).

(d) *The Yarmouk River*

Tributaries to the Yarmouk River rise on the western flanks of Jebel el Arab where they flow westward and in the Golan plateau, where they flow southward. Both westward- and southward-oriented tributaries flow through rough basaltic terrain until they join the Yarmouk River, which has cut a canyon through the basaltic rock into the underlying marly Eocene sediments. Some tributaries have also cut channels into the Eocene marls. In certain places, tributary waterfalls are formed at the point of their confluence with the Yarmouk River. The most important is the Tel Sh-Hab waterfalls. Infiltration in the basaltic terrain of Golan, Hauran and Jebel el Arab is high because of the intense joint and fracture systems that have developed in the basaltic rocks as a result of cooling and tectonism. The highest infiltration rates are found in Quaternary and recent basalts of Safa and Laja. Table 4 summarizes the groundwater and run-off components of stream flow of the main tributaries and the principal stream (Khouri, 1991).

TABLE 4. GROUNDWATER AND RUN-OFF COMPONENTS OF YARMOUK TRIBUTARIES

River/Wadi	Average annual flow run-off	Groundwater		Total
		Springs	Seepage	
Rakad river	85	45	6	173
Aalan river	37	203	11	273
Yarmouk river	24			
Wadi Ath-thahab	12			
Wadi Al-Zeidi	23			
<b>Total</b>	<b>181</b>	<b>248</b>	<b>17</b>	<b>446</b>

(e) *The Zarqa River*

The Zarqa River drains by far the largest area in the East Bank of the Jordan River. If the catchment area of the Yarmouk River is excluded from the calculations, the drainage area of small and large tributaries of East Bank areas amounts to about 6,237 km<sup>2</sup>. Of this total area, the Zarqa River drains about 4,056 km<sup>2</sup>. The Zarqa River flows mainly in carbonate terrains. However, the basement of the overlying sediments is uplifted along the eastern side of the Dead Sea Rift to form Ajloun Mountain and other highlands extending along the Rift zone the sedimentary strata generally eastwards. Such a geologic-topographic set-up has resulted in the formation of low relief in the upper reaches of the Zarqa basin and high relief in the lower reaches. The Zarqa River in the latter cuts through the cretaceous limestone into the lower (Kurnub) sandstone and Jurassic-Triassic carbonate complex. Since the regional dip is eastward, younger marly formations outcrop in the eastern part of the Zarqa River basin, this results in a flatter watershed and shallow channels. Minor tributaries run along the south-western flanks of Jebel El Arab. The Zarqa River channel

deepens southwards as it cuts into older Cretaceous and Jurassic limestone or sandstone or sandstone formations. The Zarqa River enters the flood plain and joins the main stream of the Jordan River about 40 km north of its mouth. The geomorphologic-geologic environment is reflected in the volume of sediments carried annually in the River, which is approximately 1% of the flood flow volume (Khouri, 1991). Estimated average annual stream flow of the Zarqa River is about 95 MCM. The measured flow for the period 1951-1966 was estimated at 71 MCM.

(f) *Small East Bank wadi systems*

The western flank (East Bank) of the highlands bordering the Jordan Valley is drained by small wadis which cut into rocks ranging in age between Upper Cretaceous and Triassic. The total drainage area of the small wadis of the East Bank is about 2,180 km<sup>2</sup>. The estimated annual flow of these wadis is about 112 MCM. Of this total flow, the minor wadis draining the low hilly areas account for about 9.6 MCM, and the total annual flow of higher watersheds amounts to about 102 MCM.

(g) *Small wadi systems in the West Bank*

After emerging from Lake Tiberias, the Jordan River is joined by numerous small wadis. Their total drainage area is 2,344 km<sup>2</sup>. The largest catchment is that of Wadi Fariaa (215 km<sup>2</sup>). No information is available on their contribution to the Jordan River.

#### E. NILE RIVER BASIN

The Nile River constitutes the principal water resource in Egypt. Although groundwater is important, especially in the New Valley, the renewable aquifers are hydraulically connected to the waters of the Nile, especially in the Delta area, and to some extent in other areas lying north of the Delta where Nubian and/or carbonate aquifers come into contact with the Nile. Information on surface water outside the Nile basin, such as the Red Sea and southern Mediterranean wadi systems, is sparse, and only recently have monitoring and mapping of these drainage basins been undertaken. Little is published on these ephemeral drainage systems.

As regards Nile hydrology, a considerable amount of information is available, and several publications summarize the state of the art (Khouri, 1991). On the basis of accumulated data and information on both the Nile River and groundwater (Khouri, 1991), a Water Master Plan for Egypt has been prepared (Khouri, 1991). The following paragraphs summarize the available information on the main resource: the Nile River. Since the principal tributaries, catchment areas and headwaters lie outside Egypt (in the Sudan and other countries sharing the Nile River basin), a brief description of the basin as one hydrologic unit is first given below.

*Stream characteristics:* The Nile ranks among the greatest rivers in the world. The area of its basin is about 29,600,000 km<sup>2</sup>, and its total length is about 6,825 km. The main course of the river, its tributaries and its lakes cover a large area which includes a wide range of climatic conditions; the nine countries sharing the river basin are Egypt, the Sudan, Ethiopia, Uganda, Kenya, Tanzania, Rwanda, Burundi and Zaire. The Kagera River and its tributaries are considered the headwaters of the Nile. The river discharges into Lake Victoria, out of which the Victorian Nile discharges into Lake Albert (see figure III). The Katonga River connects Lake Victoria with Lake George, which is also connected to Lake Edward (Khouri, 1991). The latter is in turn connected to Lake Albert by the Semliki River.

A considerable amount of the river water evaporates in the Great African Lakes (about 64 BCM). The river flows through rough terrain, where rapids and waterfalls are formed, before it crosses the Ugandan border at Nemule. The main stream of the Nile is known as the Upper White Nile, but it ends with a

different name: "Bahr El Jabal". It is joined by torrential tributaries before reaching Mongalla in the southern Sudan. Beyond Mongalla, Bahr El Jabal proceeds into an enormous area of marshland known as the Sudd. In the Sudd Wetlands the channel meanders, and the Bahr El Gazal River joins Bahr El Jabal from the west. Bahr El Zarof branches from Bahr El Jabal and then joins the main river course flowing eastwards. At Al Malakal, the outlet of the Sudd, the White Nile is joined by a tributary known as the Sobat River, which itself has two tributaries: the Baro River and Piber River, whose headwaters are both in the Ethiopian highlands. Many rivers flowing from the Congo and the Sudan with relatively abundant water are generally lost in the marshes from evaporation before they can reach the Nile. The river flows northward from Malakal to Khartoum, where it is joined by its major tributary, the Blue Nile. The Blue Nile has its source in Lake Tana in the Ethiopian Plateau. The river course gradients are very steep in its upper reaches. After crossing the Ethiopian border, it is joined by two tributaries: the Dinder and Rahad rivers; continuing northwards to Wadi Halfa, where the Nile is joined by the Atabara River.

In its reach between Khartoum and Lake Nasser, there are six cataracts across the Nile. Each cataract consists of a series of rapids caused by cross-beds of hard rocks forming sills or steps which are obstacles to navigation. The second cataract has been submerged below the surface of Lake Nubia, which is the extension of Lake Nasser. The Nile continues to flow northward in Egypt through deserts of very low precipitation. The length of the Nile Valley between Aswan and Cairo is about 900 km. The width varies between 2 km and 20 km, with an average of 14 km in the reach between Edfu and Cairo. The loose sediments transported by the Nile River from the Sudan and the Ethiopian highland are deposited, forming the Nile Delta.

The Nile divides at Cairo into two branches, Rosetta and Damietta, both of which empty into the Mediterranean Sea. Seepage losses (groundwater recharge) occur in the Nile Delta through the many delta branches, Ismaillia irrigation canals, and other canals. The major part of the river's flow is used for irrigation, carried via the delta branches. The base of the Nile Delta, near the Mediterranean Sea, is about 200 km.

*Stream flow:* According to the Water Master Plan of Egypt (Khouri, 1991), the flow characteristics of the Nile River can be summarized as follows: At Lake Victoria, the Nile gains water in spite of evaporation losses, with an annual flow of about 23.5 BCM. The water balance of other lakes downstream result in a net gain of about 3 BCM. After the river emerges from Lake Mobutu, its flow increases through the contributions of small tributaries, and the average flow at Mongalla is about 31.3 BCM. The inflow to the marshes and swamps of the Sudd is about 31.3 BCM. To this, about 14.6 BCM is contributed by Bahr El Ghazal and Bahr El Jabal. Thus, of the total flow (45.9 BCM), about 30.9 BCM evaporates, leaving an outflow of about 15 BCM. Channelizing the river through the Sudd swamps could decrease such high evaporation losses. The Jongli Canal is under construction for this purpose. At Malakal, the Nile is joined by the Sobat River, which adds to the Nile an average annual flow of about 13.5 BCM, for a total flow of 28.5 BCM. However, losses by evaporation from the marshy areas east of Malakal is also high.

In Khartoum, the Blue Nile discharges 54 BCM annually into the White Nile. The total Nile flow at this intersection rises to about 82.5 BCM. To this flow, the final gain is from the Atabara River (12 BCM), thus increasing the annual yield to about 94.5 BCM. The annual flow arriving in Aswan is 84 BCM.

The TDS for the Nile ranges from 175 to 180 mg/l at Aswan and 200 to 210 mg/l at the delta barrage; averages are shown in table 5.

**Figure III. The Nile River**



*The boundaries and names shown and the designations used on this map do not imply official endorsement or acceptance by the United Nations.*

TABLE 5. AVERAGE TOTAL DISSOLVED SOLIDS (TDS) CONTENT FOR THE NILE RIVER

Year	January	April	July	October
1920-1925 average	167	221	188	126
1973	208	202	185	195

The results of several water-resources studies and water-supply projects (Khouri, 1991) indicate a slight increase in TDS from the delta barrage to the north in both branches of the Nile. There is an associated rise in chloride and sulphate levels. Biological oxygen demand in both branches doubles in value in the Nile upstream of the barrage, where it ranges from 1.8 to 4.5 mg/l. Water quality deterioration increases in a northward direction owing to municipal and industrial effluents and agricultural drainage as well as decreasing flow. Table 6 gives average values of selected data for two Nile tributaries near Cairo (Khouri, 1991).

TABLE 6. CHEMICAL ANALYSIS IN THE DAMIETTA AND ROSETTA BRANCHES OF THE NILE RIVER

	Damietta branch		Rosetta branch	
	High mg/l	Low mg/l	High mg/l	Low mg/l
Chemical oxygen demand	6-8	4.0	8.0	4.2
Bacteriological oxygen demand	16.0	6.0	16.0	6.0
Total dissolved solids (TDS)	460	312	392	296
Total suspended solids	88	40	86	32
Dissolved oxygen	9.0	6.4	9	5
pH	8.4	7.4	8.4	7.4

#### E. DEVELOPMENT, MANAGEMENT EXPLORATION AND MONITORING OF SHARED SURFACE WATER RESOURCES

##### 1. General background

Surface water occurrence in the ESCWA region is independent of the artificial political boundaries between the States of the area. The Tigris and Euphrates rivers are shared by the Syrian Arab Republic, Iraq and Turkey; the Orontes River between Lebanon and the Syrian Arab Republic; the Yarmouk River between Jordan, the Syrian Arab Republic, Israel and the West Bank; and the Nile between Egypt, the Sudan and Ethiopia as well as six more African countries upstream.

There have been numerous conflicts over the use of shared international bodies of water. Both upstream and downstream countries have claimed absolute sovereign rights to such waters and have at times gone to war over such issues.

International water laws have dealt with the issue of shared surface water resources. The Helsinki Rules (1966) were adopted by the International Law Association at its fifty-second Conference, held at Helsinki in August 1966. The report of the Committee on the Uses of the Water of International Rivers

issued by the International Law Association in London in 1967 (ESCWA, 1990) defines an international drainage basin as "a geographical area extending over two or more States determined by the watershed limits of the system of waters, including surface and underground waters flowing into a common terminus. The basin State is defined as the State territory which includes a portion of an international drainage basin." According to these definitions, almost every State in the ESCWA region is sharing surface- or groundwaters with the neighbouring States. Thus, regional cooperation for water resources development is essential. In order to achieve better use of the limited water resources in the region in terms of both quantity or quality, ESCWA member States have no choice but to cooperate. There are many recognized situations that, on evaluation, call for inter-State cooperation. Past efforts to control the shared water sources in the region have lacked diplomatic initiative, negotiation and dialogue. The countries of the ESCWA region should clearly accept the principle of direct negotiations and/or indirect negotiations through a mediator or a third party as the means to solve water-related conflicts.

## *2. The Tigris-Euphrates basins (shared between Turkey, the Syrian Arab Republic and Iraq)*

### *Development and management*

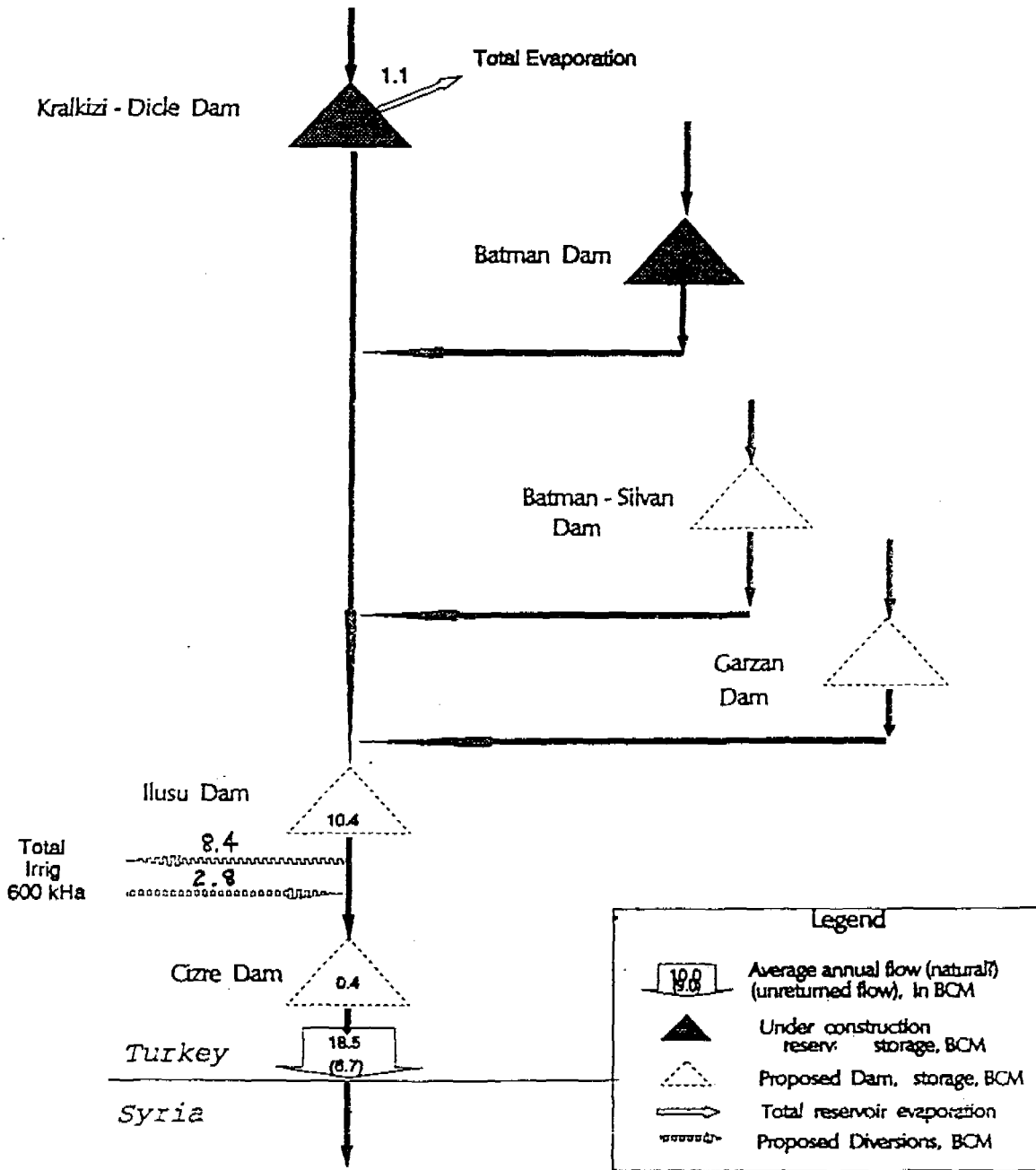
The length of the Euphrates (3,000 km) is shared by Iraq (36%), the Syrian Arab Republic (23%) and Turkey (41%). The length of the Tigris is only 1,850 km; its western part (77%) flows through Iraq, Turkey has most of the remainder (22%), and the Syrian Arab Republic has 44 km of the main river channel (Kliot, 1994). All three countries project increased water withdrawals commensurate with their urban development, population growth and increased irrigation development and hydro-power generation (especially the Syrian Arab Republic and Turkey). Many future projections for withdrawals show substantial depletion, especially in the Euphrates: the full development of GAP (Turkey) and modest development of the Syrian Arab Republic's plans indicate that Iraq will be hard-pressed to meet its own irrigation needs from the Euphrates (see figure IV). While the Tigris is thought to have adequate water and to be less susceptible to depletions, the further development of water projects will have an impact on the flow of this river as well. It is likely that neither the Syrian Arab Republic nor Iraq will be able to meet their needs during low-flow years unless water is released from existing large upstream reservoirs (Turkey).

Approximately 10% of the annual flows of the Euphrates will be lost via evaporation in Turkish reservoirs alone. Euphrates basin irrigation in Turkey may consume another 30% to 40% when all projects are completed. While the full impact of water quantity depletion may not be felt for some time, water quality problems are likely to occur in the future. Eventually, total agricultural return flows may account for more than one half of flows to Iraq via the Euphrates. Iraq's problem with already salty waters will only be further exacerbated, and it has spent much to increase the irrigated agricultural output through the implementation of projects.

The Khabour River, a tributary of the Euphrates which flows through the Syrian Arab Republic, will be heavily inundated with irrigation return flows originally diverted off-stream from Ataturk to the Urfa-Harran-Mardin plain; this area is the upper watershed for the Khabour and Belikh rivers. Irrigation return flows may rival natural stream flows, even during "normal" run-off years. All three sharing countries have programmes that call for increased water use, and all the recent efforts (from 1980 to 1990) to resolve the conflict have ended without any consensus. However, the Syrian Arab Republic and Iraq have signed a bilateral agreement to share the Euphrates waters, at 42% and 58% respectively.



**Figure IV. Tigris-Euphrates River basins: upper Tigris schematic map of water distribution**  
*(Approximate average annual flows [BCM])*  
 Projected year post 2000



### 3. THE NILE

#### *Development and management*

Nine African nations share the Nile River water resources. The Nile is the one river in the Arab region with standing formal allocation agreements. However, those agreements involve only the lower two

riparian nations, and Ethiopia is now pressing for additional water allocation. Egypt has been allocated 55.5 BCM per year but currently uses about 60 MCM. In view of its projected population increase, Egypt will need about 70 BCM per year by the year 2000. Currently, the Sudan does not have the economic resources to realize its development plans, but if it did, Egypt's allocation would likely be affected, and its water needs would far surpass what would then be available. Seasonal fluctuations make the situation even more volatile.

In 1959, Egypt and the Sudan agreed to share the water from the Nile. None of the other riparian States participated in this agreement, even though nearly all of the Nile water sources can be found in those countries. The Blue Nile and the Atabara rivers, which originate in Ethiopia, provide 86% of the Nile's flow. Currently, neither Ethiopia nor the other riparian States abstract large volumes of the water from the Nile. Fortunately, their economic development is not yet constrained by the unavailability of water, but future growth and development in the upper riparian States could cause difficulties for Egypt with regard to water allocation.

Nile water resources could be better managed if a commission comprising representatives of Egypt, the Sudan and Ethiopia or an intergovernmental panel were created to initiate a series of technical assessments of problems related to the River. The main aim of these assessments would be to protect the water against anthropogenic contamination (contamination from municipal wastes, agricultural activities and industrial emissions) and to run full chemical analyses to monitor the changes in such elements as Na, K, Ca, Mg, Cl,  $SO_4$ . Therefore, it is important to know the water balance and the genesis of salts and to evaluate the trends in quality and quantity. The commission should have logistic and technical know-how for regional monitoring in order to manage water use; it should also determine techniques for diminishing salt-water out-flow into freshwater resources, both on and below the surface.

## *2. Monitoring, exploration and investigation*

Monitoring of water quality and quantity should be done by all the participating countries in accordance with the instructions of the above-mentioned commission. Ultrasonic flow-meters and water quality data loggers should be mounted along the water courses of the Nile in close proximity to the borders of the nine countries; this is in addition to the individual measures that may be required along the Nile. A data bank should be established to collect information that will help in modelling and planning for a better future.

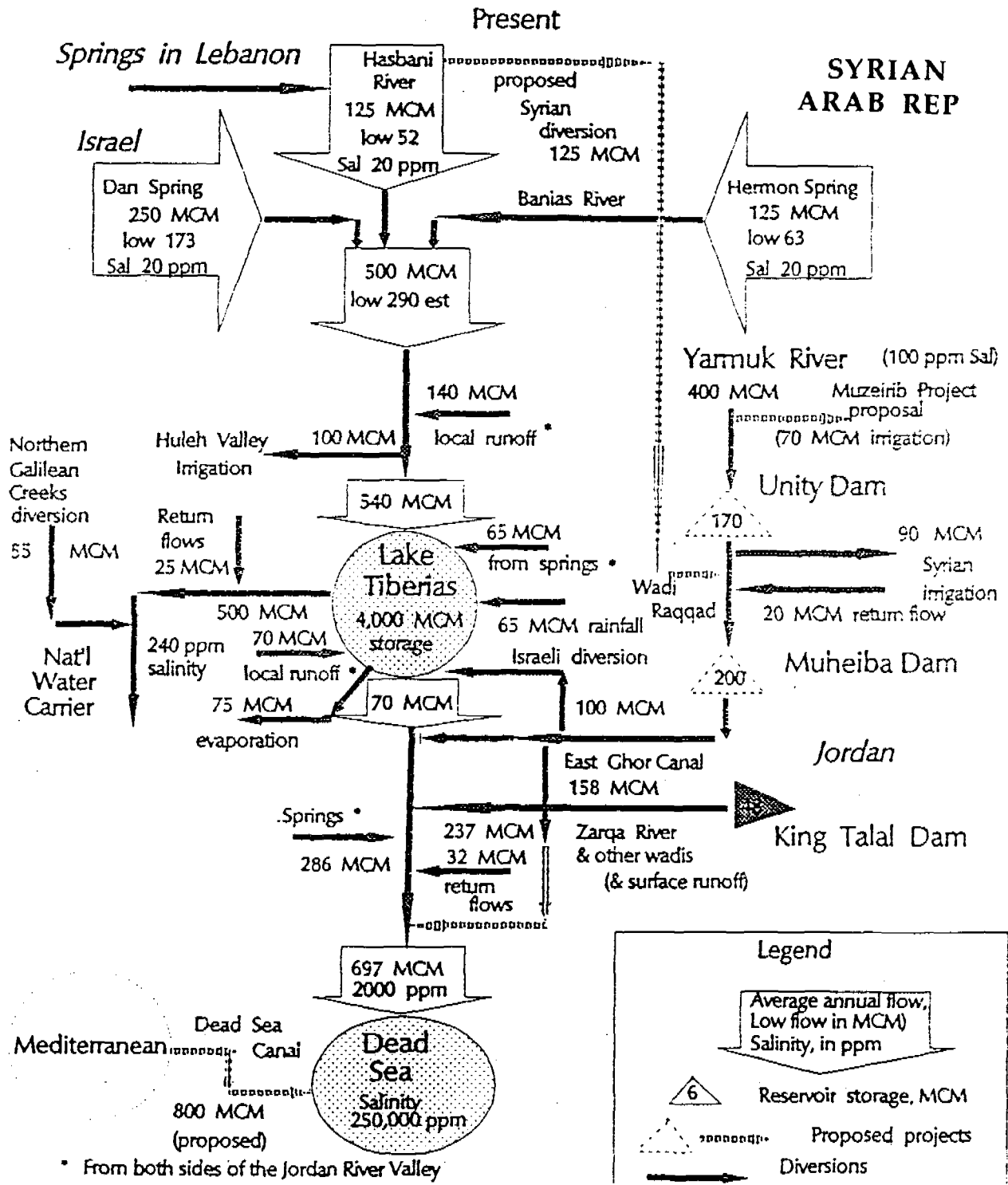
## 4. THE JORDAN RIVER BASIN

### *Development and management*

The Jordan basin includes five riparian entities: Israel, Jordan, Lebanon, the Syrian Arab Republic and the West Bank. Over the last 40 years, the Jordan River system has been the subject of much engineering ingenuity and heavy exploitation. The allocation of the River's water has been the subject of lengthy negotiations and agreement for decades (WRA, 1994). Jordan and the Syrian Arab Republic utilize most of the Yarmouk flow, leaving only about 250 MCM/a to flow on to the Dead Sea. The salinity of this water is high owing mainly to the presence of saline springs in the upper reaches and also to irrigation returns (see figure V).

Although the West Bank's riparian share is an estimated 100 MCM per year, Palestinian access to fresh surface-water resources of the Jordan basin is currently approaching zero, comprising only diverted springflow. A rational allocation of Jordan River water resources to the Palestinians would be at least 200 MCM/a, taking full account of the fact that the Jordan River basin is Jordan's only major water resource (WRA, 1994).

**Figure V. Jordan River basin: schematic map of water distribution**  
 (Approximate average annual flows [MCM], annual precipitation [mm], salinity [ppm])



The future of surface-water resources management in the region must lie in joint management of a large portion of the total water resources (Israeli and Palestinian).

A possible solution would require the following:

- (a) Construction of a west Ghor channel at the Jordan River;
- (b) Construction of a Palestinian water-supply system;
- (c) Measures to improve the water quality of Jordan River.

Brackish water treatment and desalination of sea water are not currently easy to realize from the political and economic point of view (WZB, 1995).

## References

- Khouri, J. 1991. Hydrology and Hydrogeology of Major Basins and Aquifer systems in the Mashrek, Arabian Peninsula and Nile Valley. Damascus, ACSAD.
- ESCWA. 1981. Assessment of the Water Resources Situation in the ESCWA Region. (E/ESCWA/NR/L/1)
- ESCWA. 1990. Report of the Committee on the Uses of the Waters of International River. (E/ESCWA/NR/3)
- WRAP 1994. Palestine Water Resources; a rapid interdisciplinary section review and issues paper.
- WZB, Dombrowsky. 1995. Wasser problem in Jordan becken. Reichpietschufer so-1978s. Berlin, FS 1195-9-3.

# XVIII. MAJOR GEOLOGICAL LINEAMENTS

by

*Mufid Hamza\**

## Introduction

Remote-sensing images objectively record radiometric and geometric information about the natural environment and sometimes reflect the penetrative information of a geological body at a certain depth under loose deposits. Remote-sensing images can serve to distinguish surface-water bodies, vegetation and some geological phenomena, but information about groundwater occurrence and distribution cannot be extracted directly from remote-sensing data, because groundwater is not directly observable. In order to make effective use of remote-sensing to explore groundwater, emphasis should be placed on a comprehensive interpretation of a number of hydrogeological assemblages of the remote-sensing data. These include:

- (a) Structure (faults, joints, folds);
- (b) Intrusions (dykes, veins);
- (c) Distribution of soil and unconsolidated rocks;
- (d) Geomorphology (land forms, erosion surfaces);
- (e) Drainage system and pattern;
- (f) Presence of hygrophile and hydrophile vegetation.

### A. STRUCTURAL GEOLOGY

Stresses on the earth's crust may cause deformations in the rock and produce geological structures that may be mapped on various types of images. Most sedimentary rocks have been deposited as horizontal strata, but subsequent uplifting and tilting caused the strata to become inclined.

#### 1. *Lineaments*

Linear features are objects describing the line-like character of an object or array of objects, which is correctly applied to long, often subtle, linear arrangements of various topographical, tonal, geological and even geophysical and geochemical features. The various types of geological lineaments are the following:

(a) *Folds*: The wavy undulations in the rock beds are called folds. The compressive stresses form folds, called anticlines and synclines. In an anticline, the beds dip away from the axis; in a syncline, the beds dip towards the axis. Folds are produced where a more or less planar surface is deformed to give a waved surface (see figure I);

(b) *Discontinuity*: This represents a plane of weakness within a rock mass across which the rock material is structurally discontinuous. It varies in size from small fissures to huge faults. The most common discontinuities are joints and bedding plans. Other important discontinuities are planes of cleavage and schistosity;

(c) *Joints*: These are intersecting sets of fractures along which no movement has occurred, or they may be cracks which have no displacement. Joints occur in all types of rocks; they may be vertical,

---

\* The author is a remote-sensing researcher at the Royal Jordanian Geographic Centre.

inclined or even horizontal. Joints are formed as a result of contraction owing to cooling or consolidation of rocks. They are also formed when the rocks are subjected to compression or tension during earth movements. Erosion along joints produces linear depressions that are easily interpreted on images. A group of joints which run parallel to each other are termed a joint set, while two or more joint sets which intersect at a more or less constant angle are referred to as a joint system;

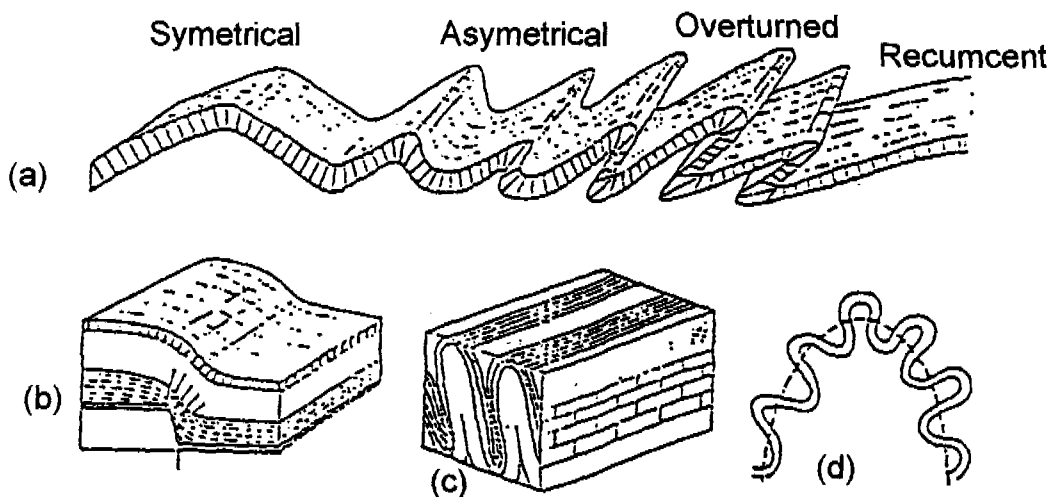
(d) *Faults*: These are fractures along which there has been relative displacement of beds. Faults are categorized according to the relative types of movement (see figure II):

- (i) Normal faults: The relative movement of rocks on either side of a fault. The topographic escarpments caused by faults are called fault scarps;
- (ii) Thrust faults: Horizontal or gently dipper faults in which the rocks overlay the faults;
- (iii) Strike-slip faults: These lie along rocks which have moved laterally;
- (iv) Other types, such as graben, horst and radial faults.

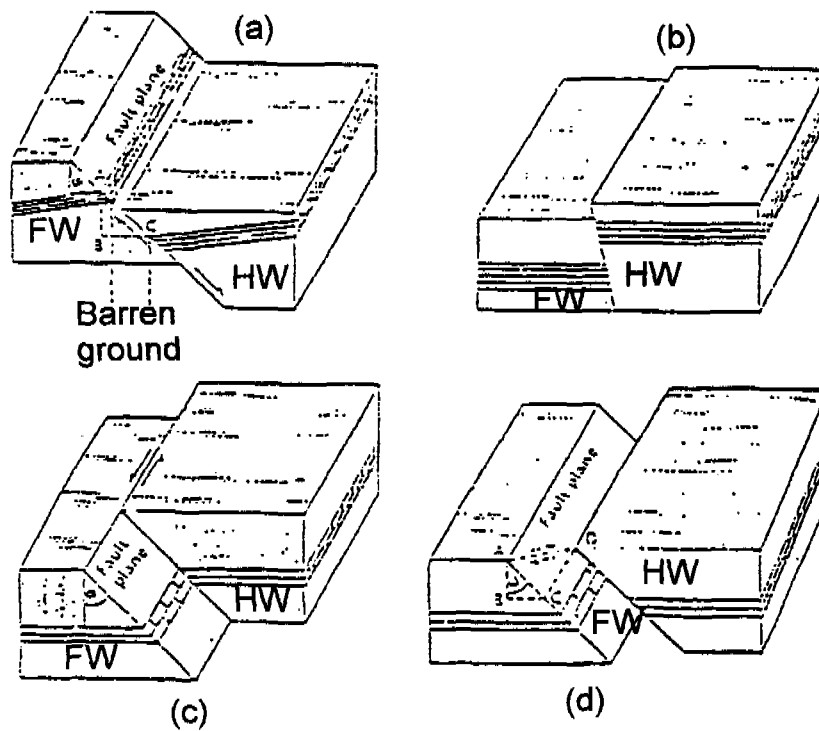
Lithological evidence of a fault includes slickensides, fault breccia and gauge, drag, dislocations, repetition and omission of beds, as well as silicification and mineralization. Physiographic evidence include fault scarp, fault tine scarp and fault control of streams;

(e) *Unconformity*: Major breaks in sedimentation, or an old erosion surface that separates younger series of rocks from older series. There are three types of unconformity: disconformity, angular unconformity and nonconformity. Unconformity occurs when changes in the paleographic conditions lead to a cessation of deposition or if uplifting and erosion have taken place, resulting in the removal of some previously formed strata (see figures III and IV).

**Figure I. Types of folds: (a) Types of folding; (b) monoclinial fold; (c) isoclinal folding; and (d) fan folding**

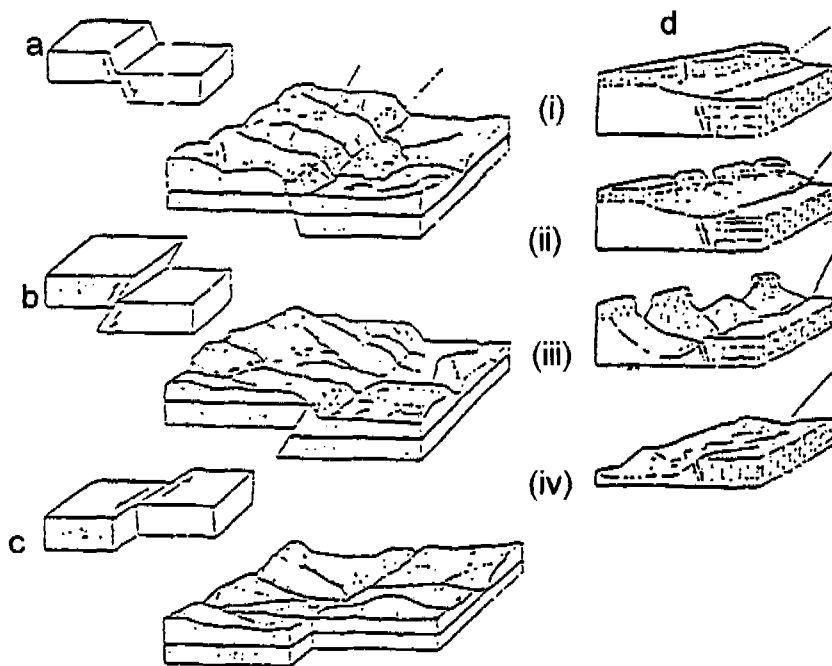


**Figure II. Types of faults: (a) normal fault; (b) reverse fault; (c) wrench or strike-slip fault; (d) oblique-slip fault**



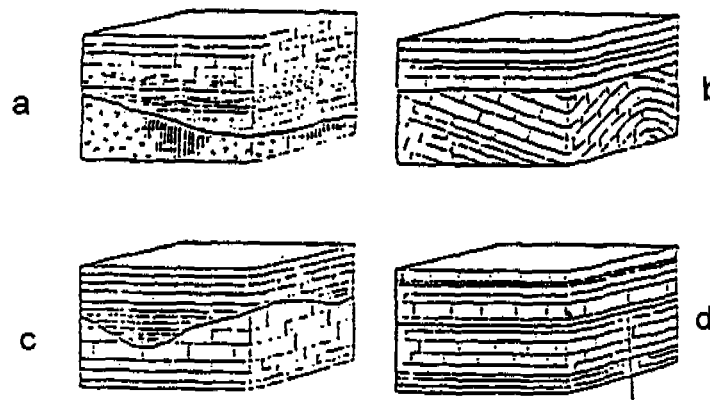
*Notes:* FW: footwall; HW: hanging wall; AB: throw; BC: heave; F: angle of hade. Arrows show the directions of relative displacement

**Figure III. The effect of erosion**





**Figure IV. Types of unconformity: (a) non-conformity or heterolithic unconformity; (b) angular unconformity; (c) disconformity; and (d) paraconformity**



## *2. Identification of lineaments by using remote-sensing technique*

Remote-sensing techniques are perhaps the geologist's most important tool for mapping lithological structures. Direct lithostructural mapping is possible only if the different rock types are sufficiently exposed and distributed. This works best in terrain with little or no soil cover and sparse vegetation, such as a desert. Primary and secondary structures can be mapped indirectly from an analysis of their morphological expression in most terrains. However, not all the linear features (lineaments, fracture traces, joints) so apparent on remotely sensed images can be attributed to underlying faults, dykes, fissures, fractures or joint sets. Mapping of lineaments using remote-sensing techniques can be useful in geological and hydrological investigations if (a) strict criteria for the definition of the lineaments are adhered to, and (b) the maps are used as a part of a multidisciplinary integration.

The photographic interpretation of lineaments is often more reliable than their detection in the field since they are usually weaknesses of surface and are rarely seen at outcrop. They often control low-lying features and are difficult to recognize from a close distance. Changes in vegetation and surface texture related to geological structure are difficult to see when the geologist is close to them.

For the identification and determination of the lineaments which are favourable indicators of groundwater accumulation and movement, the following major surface features were used:

- (a) Geomorphic features caused by relief, including aligned segments of relief, straight stream valleys and alignment stream segments;
- (b) Tonal features caused by contrast or tonal differences, including straight boundaries between areas of contrasting tone (differences in vegetation, soil moisture, soil or rock composition).

The upper-synoptic view provided by satellite images is ideal for re-evaluating structural patterns and other reflections of brittle tectonics over a large area. Individual scenes or mosaics of many scenes can be used to highlight the inter-connectedness of tectonic features. Linear features or lineaments can be mapped

very quickly and linked to notions of the tectonic evolution of an area. The best results are from areas of high relief and recent activity, where the structures are well expressed and where evidence of the direction of movement is clearest.

Lineaments were mapped from a variety of images as follows:

Type	Source	Bands	Dates
Black and white and colour	Landsat MSS	1,2,3	1990
Colour	NOAA	1,2	1994

The tonal lineaments were best identified from the false-colour infrared and enhanced single bands. The following criteria were used to define significant lineaments:

- (a) Continuous linear segments (stream tonal anomalies, for example);
- (b) Linear stream tributaries that are parallel with the topographic or dip slope;
- (c) Discontinuous linear features had to cross a drainage divide or stream;
- (d) Alignment of a major continuous stream valley was considered more significant than alignment of main and tributary stream channel segments;
- (e) Strike valley was considered;
- (f) Linear tonal anomalies could not align with roads, railroads or pipelines;
- (g) Linear tributaries located on opposite sides of the major trunk stream, which were parallel and met at the same point on the stream, were considered more significant than those that met at any angle;
- (h) Linear alignment of a vegetation type for a greater distance, which is usually expressed as a tonal anomaly, was mapped as a lineament.

## B. METHODOLOGY

The methodology of the work involves using MSS Landsat and NOAA images after mosaic processes and geometric correction. The lineament could then be identified according to the following:

- (a) *Color composite images*: From Landsat MSS images after a linear stretch and a power stretch, the color composite from bands 1, 2 and 4 and color composite from NOAA image bands 1 and 2 were found to be the best selection of images for identification;
- (b) *Filtering*: This is commonly used to (i) restore imagery after a system malfunction; (ii) enhance the imagery for visual interpretation; and (iii) extract features using the local spatial frequency constant. The following is the main type of filtering:
  - (i) *Convolution, smoothing filters*: These filters are also known as low-pass filters. They are used to suppress noise but are not suitable for the creation of imagery for visual interpretation because of loss of sharpness;

- (ii) *Contrast enhancement, edge enhancement filters*: The enhancement of linear elements in the scene (such as a drainage line, lineaments, field boundaries) may be achieved by operators. The strength of the local gradient can be enhanced by the sobel filters by applying the operator in two directions:

$$\begin{array}{cc} 1 & 0 & 1 & & 1 & 2 & 1 \\ 2 & 0 & 2 & \text{and} & 0 & 0 & 0 \\ 1 & 0 & 1 & & 1 & 2 & 1 \end{array}$$

A laplacian directional filter was also used to emphasize higher spatial frequencies. This involved a convolution operation to increase lineament contrast. MSS band 4 was selected, and a directional filter was applied. The filter consists of two kernels, each of which is an array of three-by-three pixels:

$$\cos A \begin{array}{ccc} 1 & 0 & 1 \\ 1 & 0 & 1 \\ 1 & 0 & 1 \end{array} + \sin A \begin{array}{ccc} 1 & 1 & 1 \\ 0 & 0 & 0 \\ 1 & 1 & 1 \end{array}$$

The left kernel is multiplied by the  $\cos A$ , where  $A$  is the angle relative to the north of the linear direction to be enhanced. The right kernel is multiplied by  $\sin A$ . The first time,  $A$  was chosen to be 45 degrees, and the linear feature to the north-east was highlighted. The second time,  $A$  was chosen to be -45 degrees, to highlight linear features mostly in the north-west. Later,  $A$  was assigned 90, 65 and -65 degrees to highlight lineaments in different directions. In the Dipix system, different directions, such as N, NE, NW and E, were used. The lineaments were identified by visual inspection (see figure V). A remotely sensed lineament map was produced on the basis of the total knowledge compiled from edge enhancement and single band composites.

### 1. *The importance of lineaments*

In addition to their importance in tectonic analysis, many types of lineaments (such as faults) have economic importance. As zones of intense fracturing, they allow various fluids to pass with ease. Because vertical faults are not influenced by topography—they cross from areas of high elevation and rainfall to plains with shortages of drinking and irrigation water—they may transfer large supplies to areas of need. Fracturing of the crust can also focus the movement of water and other fluids.

The intensity of fracturing along faults forms local weaknesses. These become eroded and form linear depressions, often followed by streams. Since the tendency of streams to meander is almost irresistible, any straight segment raises the suspicion of fault control. There are relatively few cases of faults which have been cemented by percolating fluids or followed by igneous dykes.

The high permeability of fault zones means that they can become saturated with water. They provide easy access for root systems, and when forming depressions, they protect plants from wind and desiccation. Lines of vegetation encouraged by these conditions are also potential indicators of faults, but joints provide exactly the same conditions, and other evidence is needed for confirmation. Where faults have thrown permeable rocks against impermeable rocks, spring lines may form. In the case of limestone thrown against impermeable rocks, local drainage may disappear into lines of sinkholes marking the fault.

**Figure V. Lineament interpretation: Azraq-Wadi Sirhan area**



In general, the methodology of groundwater resources is based on the analysis and synthesis of the following elements:

- (a) Study of the hydrographic network;
- (b) Analysis of the lineaments;
- (c) Cartography of superficial formations;
- (d) Analysis of indirect clues, such as land use, vegetation and humidity traces.

Lineaments play an important role in groundwater studies, particularly in regions with hard rocks. For such studies, remote-sensing imagery has to be transformed so as to enhance optimally the surface features of interest. Three-by-three gradient filters in x-direction and in y-direction are applied on the images. The interpreter has to decide which of the lineaments relates to tensional fracturing since these are the most promising for groundwater occurrence in the region.

Fracture permeability and leakage through confining layers can have an significant effect on flow in aquifer systems. Although little is known concerning the nature of leaking or the processes or mechanisms involved, such indicators as hydrochemical, geothermal and seismic anomalies and their correlation with surface lineaments may help to define regional areas of leakage.

Water degradation, the movement of water under gravity, leading to erosion, can be seen as the chief degradation process wherever hydrographic networks indicate the dominance of fluvial action. The only exceptions to this are in arid or semi-arid areas, where there is either compelling evidence of wind action in the occurrence of scour or deflation patterns and active sand or loose deposition or salinization and alkalization, as seen from the even tones and seasonally high reflectivity of the topographic basin.

### C. CONCLUSION

Remote-sensing can provide useful information on geology, geomorphology and hydrology, lineaments, land cover, vegetation and drainage systems, all of which are indicators of subsurface hydrological conditions and groundwater occurrences. All mapped lineaments are supposed to represent faults or major fracture zones, although some of the mapped lineaments may actually be features such as vegetation changes, erosional escarpments and dune fronts. Lineaments that represent surface expressions of major basement discontinuities may indicate where the hydraulic properties of an aquifer system have been altered by tectonic movement. These discontinuities are believed to have affected depositional patterns. Accordingly, the permeability and thickness of aquifers and their confining beds may have been affected. In remote-sensing techniques, the gradient filters in different directions and the color composite is the best enhancement with which to highlight the linear features. In groundwater studies, the detection of lineaments can be of direct importance because high-yielding wells are often found in the high-density area of lineaments and are useful for locating drilling sites.

# XIX. PRINCIPLES OF GROUNDWATER EVALUATION OF CRYSTALLINE AQUIFERS

by

*A.N. Charalambous\**

## Abstract

Basement aquifers in the ESCWA region appear to have received little attention, perhaps owing to their low yields but also owing to the existence of much more productive aquifers and groundwater basins. In Africa and the Middle East, basement aquifers provide limited water supplies to small communities and villages. Although many who have studied these aquifers have concluded that there is a need to increase the general understanding of the hydrogeological principles involved, the fact remains that they are poor aquifers, and their productivity is not easily predictable despite the utilization of sophisticated geophysical and remote-sensing techniques.

### A. OCCURRENCE

Basement rocks are generally of pre-Cambrian age and occur on either side of the Red Sea. They extensively outcrop east of the Red Sea, in the western region of the Arabian Peninsula, stretching from near the Gulf of Aqaba in the north to the Gulf of Aden in the south. On the western side of the Red Sea, basement rocks extend from Egypt in the north to the Sudan in the south.

### B. NATURE OF BASEMENT AQUIFERS

Groundwater in basement rocks occurs in weathered residual mantle (the regolith) and in fractured bedrock. In the Arabian Peninsula, there appears to be no thick development of weathered overburden, so groundwater is mainly stored in fractures. There are no known large water supplies. In general, it is thought that groundwater occurs in discontinuous blocks within fracture systems. Permeability and storativities are low. In the arid, low-rainfall environments of the ESCWA member countries, yields from boreholes are not likely to be sustained for long periods. Individual well yields are low (typically less than 0.5 l/s). "Studies in the Basement Aquifers of Africa" (Boeckh, 1992) suggests that relations between particular features which can be observed (e.g. lineaments) or measured (regolith thickness or electrical resistivity) are of little value in citing individual boreholes (Wright, 1992). Statistical studies of 163 boreholes in southern Zimbabwe (Greenbaum, 1992) which were mostly located on the basis of fracture or dyke-related lineaments showed that their yields had no relation to proximity to lineaments, azimuth or lineament length. In Malawi, well yields do not show a relationship with regolith thickness, and similarly in Zimbabwe.

### C. EVALUATION TECHNIQUES

Two main techniques are currently in use to evaluate groundwater occurrence in crystalline aquifers: geophysical techniques and remote-sensing techniques.

---

\* The author is the Director of Hydrogeological Services International Ltd., London.

### 1. *Geophysical techniques*

Resistivity sounding applied in the vertical electric sounding (VES) mode is used to investigate regolith aquifers. Electromagnetic (EM) conductivity mapping methods are the most appropriate when looking for fracture zones. Geophysical techniques have proved useful, but their success cannot be related to the amount of geophysics used. When these techniques are applied, it is important to bear in mind local knowledge, existing borehole information and site-specific hydrogeology.

### 2. *Remote-sensing techniques*

Remote-sensing techniques (aerial photography or satellite imagery) have been used to locate fractures in basement rock. In the basement rocks of Burkina Faso, Landsat-MSS revealed the regional fracture pattern, and Landsat-TM imagery permitted the identification of active dry-season vegetation, which assisted in identifying promising groundwater abstraction points (Boeckh, 1992). In Zimbabwe, D. Greenbaum (1992) used Landsat-MSS imagery and aerial photography to produce digitized lineament data which were used to provide, *inter alia*, lineament plots, lineament density plots and rose diagrams. He concluded that a correlation between borehole yields and lineaments did not convincingly demonstrate the existence of any favourable "open" fracture directions. Moreover, studies in several countries in Africa and elsewhere suggest that the optimum depth for boreholes in basement rock ranges from 40 to 80 metres, as at this depth existing fractures tend to open and new fractures to form. This means that fractures of all direction types are potentially permeable without any particularly favoured lineament directions. Landsat lineaments are often useful when used in conjunction with EM surveys, but perhaps very detailed lineament analysis may not be able to provide the desired results, as most of the important fractures occur at some depth.

## D. DEVELOPMENT OF CRYSTALLINE AQUIFERS

The development of crystalline basement aquifers should make use of geophysical surveys and Landsat lineament mapping, where appropriate and cost-effective. In basement rock aquifers where a regolith is absent, borehole depths should not exceed 80 metres, unless very deep fracturing is suspected. Radial large-diameter collection wells may provide larger yields than can normally be obtained from narrow boreholes.

## **Bibliography**

- Boeckh, E. 1992. *An exploration strategy for higher yield boreholes in West African crystalline basement.* Geological Society Special Publication, No. 66.
- Greenbaum, D. 1992. *Structured influences on the occurrences of groundwater in SE Zimbabwe.* Geological Society Special Publication, No. 66.
- Wright, E.P. 1992. *The hydrogeology of crystalline basement aquifers in Africa.* Geological Society Special Publication, No. 66.



## XX. HYDROGEOLOGICAL OVERVIEW OF AQUIFER SYSTEMS IN THE ESCWA REGION

by

*A.N. Charalambous\**

### *Abstract*

The ESCWA region is characterized by diverse climatic, geomorphological and geological conditions which directly and indirectly influence groundwater occurrence. Superimposed on this is the effect of the palaeoclimate, a controlling factor in recharging those aquifers, which today receive little or no replenishment, owing to the prevailing aridity in much of the Arabian Peninsula and the Sahara. Groundwater is an important source of water for all ESCWA member countries, especially those in the arid regions of the Arabian Peninsula. There have been numerous studies and investigations carried out in individual countries, though little work has been done on a regional scale. Extensive exploitation in recent years, partly owing to the increases in water demand but also to technological advancements in drilling and pumping equipment, has meant that regional aquifer systems which transgress national boundaries can no longer be viewed in isolation, within the context of individual country borders. Various students of Middle East hydrogeology have recognized this, and as early as 1969, various aquifer system classifications were proposed, and hypotheses were offered on modes of replenishment and on groundwater flow and discharge.

### **Introduction**

The present paper, prepared as part of a UNEP/ESCWA project on "Assessment of water resources in the ESCWA region using remote-sensing techniques", is one of a series of papers presented to ESCWA participants during the training course on Using Remote-Sensing Data and GIS, Techniques in Hydrology and Hydrogeology.

The paper, a general overview based on published works rather than an exhaustive investigation, describes the hydrogeology of the ESCWA region's major aquifer systems. It should be read in conjunction with the relevant Regional Hydrogeological Map on the scale 1:2,500,000.

#### A. REGIONAL GEOLOGY

##### 1. *Tectonic framework*

Powers and others (1966) recognized two major structural provinces in the ESCWA region: a stable interior province which includes all of Saudi Arabia and most of the Arabian Peninsula; and a mobile belt peripheral to the stable region and comprising the Taurus-Zagros-Oman mountains.

The stable province is divided into two structural units: (a) the Arabian Shield, which is characterized by an extensive outcrop of Precambrian rocks located in western Saudi Arabia and extending from the Gulf of Aqaba to the Gulf of Aden; and (b) the Arabian Shelf, which is situated to the east of the Shield and covers all of the eastern Arabian Peninsula (excluding the Oman Mountain belt), Jordan, the Syrian Arab Republic, and Iraq. The Arabian Shield is separated from the African Shield by the Red Sea rift, which was

---

\* The author is the Director of Hydrogeological Services International Ltd., London.

formed in the late Tertiary period during the Alpine orogeny. It is during this time that the Zagros-Taurus chain of mountains was formed in the mobile belt.

Bordering the Shield is a belt of Palaeozoic, Mesozoic and Cenozoic rocks dipping gently eastwards at an angle of less than 1°. This gentle homoclinal structure stretches from the Rub' al Khali (Saudi Arabia) in the south to Jordan and Iraq in the north. Changes in strike in the homocline have produced a number of segments (Powers and others, 1966) the most important of which are:

(a) The Central Arabian Arch of Saudi Arabia, which extends from Ha'il in the north (27°32' N, 41°45' E) to the Rub' al Khali in the south. In the past, it probably marked an area between a stable or slightly rising province to the west and a sinking area to the east. It appears to have originated in the middle Cretaceous with the deposition of the Wasia formation. Subsidence east of the Arch in the late Cretaceous and Tertiary provides produced a large thickness of mainly carbonates (Aruma, Umm-er-Radhuma, Dammam and younger formations);

(b) The Ha'il Arch, is defined by a change in strike of the homocline stretching northwards from Ha'il in Saudi Arabia into the Rutbah Arch in Iraq. The emergence of the Ha'il Arch during the Cretaceous divided the homocline into two segments, a western segment comprised mainly of Palaeozoic rocks and an eastern segment made up of Cretaceous and younger sediments.

Other significant structures include the Hadramaut Plateau in south Yemen and the Rub' al Khali, Azraq-Sirhan and Palmyran basins, where thick Mesozoic and Cenozoic rocks were deposited. Folding initiated as early as the late Cretaceous period has produced a number of north-south-trending anticlinal structures, the most important of which are the Bahrain pericline, the Dammam dome, and the Ghawar and Qatar anticlines. Secondary structures which influence the flow regime in eastern Saudi Arabia are solution collapse features associated with evaporite deposits.

## 2. Stratigraphy

Table 1 shows the general Palaeozoic, Mesozoic and Cenozoic stratigraphy of the ESCWA region. A short description of the main lithostratigraphic groups and formations is presented below.

### (a) *Precambrian rocks*

Precambrian rocks outcrop in the Shield area of western Saudi Arabia, in southern Jordan, in the Sinai Peninsula and in Yemen. They consist mainly of granites and other igneous rocks, including intrusive sills and dykes, as well as metamorphic rocks.

### (b) *Palaeozoic rocks*

The Cambrian, Ordovician and Silurian periods are represented mainly by clastic rocks (sandstones and shales). Cambro-Ordovician sandstones are exposed in a narrow outcrop east of the Dead Sea-Wadi Araba graben and continue southwards through southern Jordan and into north-west Saudi Arabia as far as 'Unayzah (central) and 'Assir (west). The Silurian comprises micaceous shales and fine- to medium-grained sandstones; it is exposed in the southern Desert of Jordan and north-west Saudi Arabia, its outcrop aligned parallel to the Cambro-Ordovician. The entire succession dips gently to the east and north-west beneath a thick deposit of younger sediments; thus, in the rest of Saudi Arabia (Al-Nafud and Rub' al Khali) and in Jordan, the occupied territories, the Syrian Arab Republic and Iraq, the lower Palaeozoic is found at depths ranging from 1,000 to more than 3,000 metres.

TABLE 1. GENERAL LITHOSTRATIGRAPHY IN THE ESCWA REGION

ERA	Period	Epoch	Age	COUNTRY																		
				Egypt	Syria	Jordan West Bank	Iraq	Saudi Arabia & Gulf States	North Yemen	South Yemen	Oman											
CEANOZOIC	QUATERNARY	Holocene	Pleistocene	alluvium/plays	alluvium	alluvium	sands, clays & sandstones	Kharj Fm	alluvium													
				alluvium	alluvium	alluvium	alluvium	alluvium	alluvium	alluvium	alluvium	alluvium										
	TERTIARY	Neogene	Pliocene	clay, sand, slt.	siltstone	basalt	Qirna Fm	Bakhtian Fm	Hafuf Fm	basalt	Aden Volcanics											
			Miocene	limestone clastics gypsum	sandstone			Upper Fars Fm	Lower Fars Fm	Dam Fm	Yemen Volcanics	Baid Fm	marl limestone gypsum									
			Oligocene	gravel conglomerate	basalt		Tayyiba Fm	Ghar/Euphrates	Baba, Agani, Anbu	Shech, Alas, Shuruf	Hadrutah Fm		Shihir Group									
				limestone & chert	limestone		Wadi Shalkala Fm						Hobshiya Fm	Jeza Fm								
		Paleogene	Eocene	Lutetian		marl, chert & chert		Rijam Fm		Dammam Fm		Medj-Zir Series		Dammam Fm								
				Ypresian						Rus / JI	Rus Fm			Rus Fm								
				Thanetian																		
				Palaocene	Danian										Umm er Radhuma Fm							
MESOZOIC	CRETACEOUS	Upper	Maestrichtian	marl/shale	Nubia Fm Ss/Shale																	
			Companion	phosphates, clastics & carbonates		limestone																
			Santonian			marl & dolomite																
		Coniacian																				
		Middle	Turonian	fossiliferous slt/clastics																		
			Cenomanian																			
	Albian																					
	Lower	Aptian	shales, carbonates & clastics																			
		Barremian																				
		Hauterivian																				
Valanginian																						
JURASSIC																						
													limestone dolomite & anhydrite									
TRIASSIC																						
													carbonates & clastics									
PERMIAN																						
PALEOZOIC	CARBONIFEROUS																					
	DEVONIAN																					
	SILURIAN																					
ORDOVICIAN																						
CAMBRIAN																						

Precambrian basement complex

In Saudi Arabia, the Cambro-Ordovician is represented by the Saq Group and in Jordan by the Ram (previously Disi) Group. In the occupied territories, only the lower part of the sequence is present (the Yamsaf Group), while in the Syrian Arab Republic, there are a number of formations with no collective name. The thickness of the Cambro-Ordovician sandstones ranges from a few hundred metres at outcrop to more than 3,000 metres in the subsurface. The Ordovician-Silurian is represented by the Tabuk formation in Saudi Arabia and its equivalent Khreim Group in Jordan. In the occupied territories and western Jordan the Khreim Group is absent, while in the Syrian Arab Republic, it is represented by the Swab, Afandi and Tunf formations. In Saudi Arabia, the upper part of the Tabuk is of Lower Devonian age. The Tabuk/Khreim groups have a thickness ranging from a few hundred metres at outcrop to more than 1,000 metres in the subsurface.

The Devonian is thought to be represented in Saudi Arabia by the Jauf formation, a sequence of more than 300 metres of limestone, shale and sandstone. In Jordan, the Devonian has not been identified. In the Rutbah area of Iraq, a thick Palaeozoic and Cambrian succession (7,000 to 9,000 metres thick) is thought to exist (Andrews, 1991).

The Carboniferous is absent at outcrop but is probably represented at depth. In general, an unconformity exists between the lower and the upper Palaeozoic; thus, the Permian rests unconformably on the early Palaeozoic. The Permian occurs at outcrop in Saudi Arabia (Wajid sandstone and Khuff limestone) but has not been identified in Jordan. The Wajid sandstone also occurs in northern Yemen. The thickness of the Permian may reach more than 6,000 metres.

In Egypt, the Carboniferous-Middle Cretaceous is represented by the Nubian sandstone (with a thickness of 500 to 3,000 metres), mainly arenaceous succession resting on the Precambrian basement.

(c) *Mesozoic rocks*

(i) *Triassic*

The Triassic is exposed along a relatively short and narrow outcrop east of Riyadh in Saudi Arabia and in the Rutbah area of Iraq. Elsewhere, it occurs in the subsurface at depth. In Jordan, it is only found at depth in the panhandle areas (eastern Jordan). In Saudi Arabia, it consists of limestones and shales with sandstones at the top (Jilh and Minjur sandstones) and has a thickness of more than 700 metres. In Jordan, the Ramtha Group comprises clastics, carbonates, dolomites and anhydride and has a thickness of 120 to 1,200 metres. In the Syrian Arab Republic, the Triassic is tentatively differentiated from the Jurassic and has similar lithologies to the Jordanian group and a thickness of 100 to 500 metres. In Iraq, the Triassic is dominated by evaporitic and limestone facies.

(ii) *Jurassic*

Jurassic rocks outcrop along the Dead Sea in Jordan, in the Rutbah area of Iraq, in Sakakah and along the Central Arabian Arch as far as the Rub' al Khali in Saudi Arabia, and in north and south Yemen. Elsewhere, they occur in the subsurface. Lithologically, the Lower Jurassic consists mainly of carbonates and shales and the Upper Jurassic of calcarenites and anhydride. In Yemen, the limestones are argillaceous (Amran limestones) and are underlain by the Kohlan sandstones. In Jordan, they consist of dolomitic limestone and anhydride (Azab or Zarqa formations), with similar lithologies in the occupied territories, the Syrian Arab Republic and Iraq. The Jurassic has a thickness between 100 and 2,500 metres.

(iii) *Cretaceous*

The Cretaceous is exposed in central Saudi Arabia parallel to the Jurassic outcrops; in the western highlands of Jordan and in the occupied territories; in south-west Iraq, the north-west part of the Syrian Arab Republic and Lebanon; in Oman and Yemen; and in Egypt. The Lower Cretaceous is normally dominated by carbonate rocks, the late Lower Cretaceous and middle Cretaceous by clastic rocks, and the Upper Cretaceous mainly by carbonates. The clastic rocks of hydrogeological importance are the Biyadh-Wasia-Sakakah sandstones of Saudi Arabia, the Kurnub sandstone of Jordan and the occupied territories, the Tawilah sandstone of Yemen, and part of the Nubian sandstone of Egypt. Water-bearing carbonate rocks include the Aruma limestone of Saudi Arabia; the Tayarat limestones of Iraq; the Cenomanian-Turonian limestones of the Syrian Arab Republic, Lebanon and the occupied territories; and the Amman-Wadi Sir limestones of Jordan. The thickness of the Cretaceous ranges from a few hundred to several thousand metres.

(d) *The Cenozoic*

(i) *The Tertiaries*

The Tertiaries outcrop extensively throughout the region. The lower Tertiaries (Palaeocene-Eocene) mainly comprise carbonate rocks and evaporites. The upper Tertiary (Neogene) consists of clastic sediments (sandstones, conglomerates, shales), sandy limestones, gypsiferous marls and dolomites. Of hydrogeological significance are the Umm-er-Radhuma and Dammam limestones (Palaeocene and upper eocene respectively) of Saudi Arabia, Iraq and the Gulf States, and the Rijam limestone (lower Eocene) of Jordan. Clastic late Tertiary sands and gravels have developed in the Nile Valley and Nile Delta of Egypt and in Kuwait.

During the Miocene-Pliocene, intense volcanic activity led to the extrusion of a continuous belt of lava and pyroclastic rocks extending from the southern Jebel el Arab region of the Syrian Arab Republic, through eastern Jordan into north-eastern Saudi Arabia. In Yemen, Tertiary and Quaternary volcanics (the trap series) occupy the central part of the country. The volcanics in both regions range in thickness from a few hundred to more than 2,000 metres.

(ii) *The Quaternary*

The Quaternary includes mainly continental fluvial, lacustrine and aeolian deposits and volcanics. They occur along the major river floodplains of the Nile, Tigris and Euphrates, the Tihama coastal region of Yemen and Saudi Arabia, the Jordan Valley and Wadi Araba, and the Gaza Strip.

## B. THE AQUIFER SYSTEMS

### 1. *Classification*

Italconsult (1969) divided the aquifers of the Arabian Peninsula into recharging and non-recharging aquifers. Depleting aquifers are part of the post-Jurassic system, which non-depleting aquifers belong to the Palaeozoic (Saq/Ram, Tabuk and Wajid sandstones) and the Triassic-Jurassic (Minjur-Dhruma).

The Food and Agriculture Organization of the United Nations (FAO, 1979) proposed two aquifer systems: System A, which receives recharge inland in Saudi Arabia and underflows to the east to discharge in the Gulf; and System B, comprising shallow, unconsolidated aquifers extending from the coast of Saudi Arabia across Bahrain and Qatar and into central Abu Dhabi. System A is further subdivided into an upper aquifer which includes those aquifers overlying the Rus formation; a middle aquifer which includes the Rus, Umm-er-Radhuma and the Aruma; and a lower aquifer which includes the Wasia/Biyadh complex.

Khouri (1991) recognized six main aquifer complexes differentiated by geological age in the ESCWA region (see table 2); he then divided these into 20 aquifer systems, as shown in table 3.

TABLE 2. AQUIFER COMPLEXES IN THE ESCWA REGION

Aquifer system	Geological age	Aquifers
Lower continental sandstone	Palaeozoic-lower Mesozoic	Ram/Saq, Tabuk, Wajid, Minjur
Upper continental sandstone	Upper mesozoic	Biyadh, Wasia, Kurnub, Tawilah, Nubian
Lower carbonate	Mesozoic	Aruma; Amman-Wadi Sir; Cenomanian-Turonian of Lebanon, the Syrian Arab Republic and Palestine
Upper carbonate	Tertiary	Umm-er-Radhuma, Dammam, Rijam; carbonates of the Syrian Arab Republic
Alluvial (clastic)	Neogene and Quaternary	Nile Valley and Nile Delta; Jezira and Wadi Batin aquifers of Iraq; Jordan Valley and Wadi Araba alluvials; Gaza Strip sands and sandstones; Tihama alluvials of Yemen and Saudi Arabia; Kuwait Group clastics of United Arab Emirates; Batinah alluvials in Oman;
Volcanics	Neogene and Quaternary	Basalts of the Syrian Arab Republic, Jordan, Saudi Arabia; Yemen Trap volcanics

Source: J. Khouri, "Hydrology and hydrogeology of the major basins and aquifer systems in the Mashrek, Arabian Peninsula and Nile Valley (Damascus, ACSAD, 1991).

In the Regional Hydrogeological Map (on the scale 1:2,500,000) the classification of aquifer systems is based on the 1:500,000 hydrogeological map (sheet 2) prepared by the Arab Centre for the Study of Arid Zones and Dry Lands (ACSAD) and the United Nations Educational, Scientific and Cultural Organization (UNESCO) in 1988 and on other relevant geological and hydrogeological maps. The Regional Hydrogeological Map consists of three sheets: sheet 1 (north), which covers the Syrian Arab Republic, Lebanon, the West Bank and Gaza Strip, Jordan, the eastern part of the Sinai Peninsula, Iraq, Kuwait, northern Saudi Arabia, Bahrain and Qatar; sheet 2 (south), which covers southern Saudi Arabia, Yemen, the United Arab Emirates and Oman; and sheet 3 (west), which covers Egypt including the western part of the Sinai Peninsula. Figure I shows the position of the three sheets in the ESCWA region.

The geological strata are classified according to lithology, age and hydrogeological character; eight lithological and seven hydrogeological units are delineated, as follows:

(a) *Lithological units:*

- Alluvial deposits
- Sandstones
- Sandstones and limestones
- Limestone, dolomite, chert
- Marl and marly limestone
- Evaporites
- Eruptives (lavas)
- Intrusive, crystalline and metamorphic (mainly basement) rocks

TABLE 3. GROUNDWATER SYSTEMS IN THE ESCWA REGION

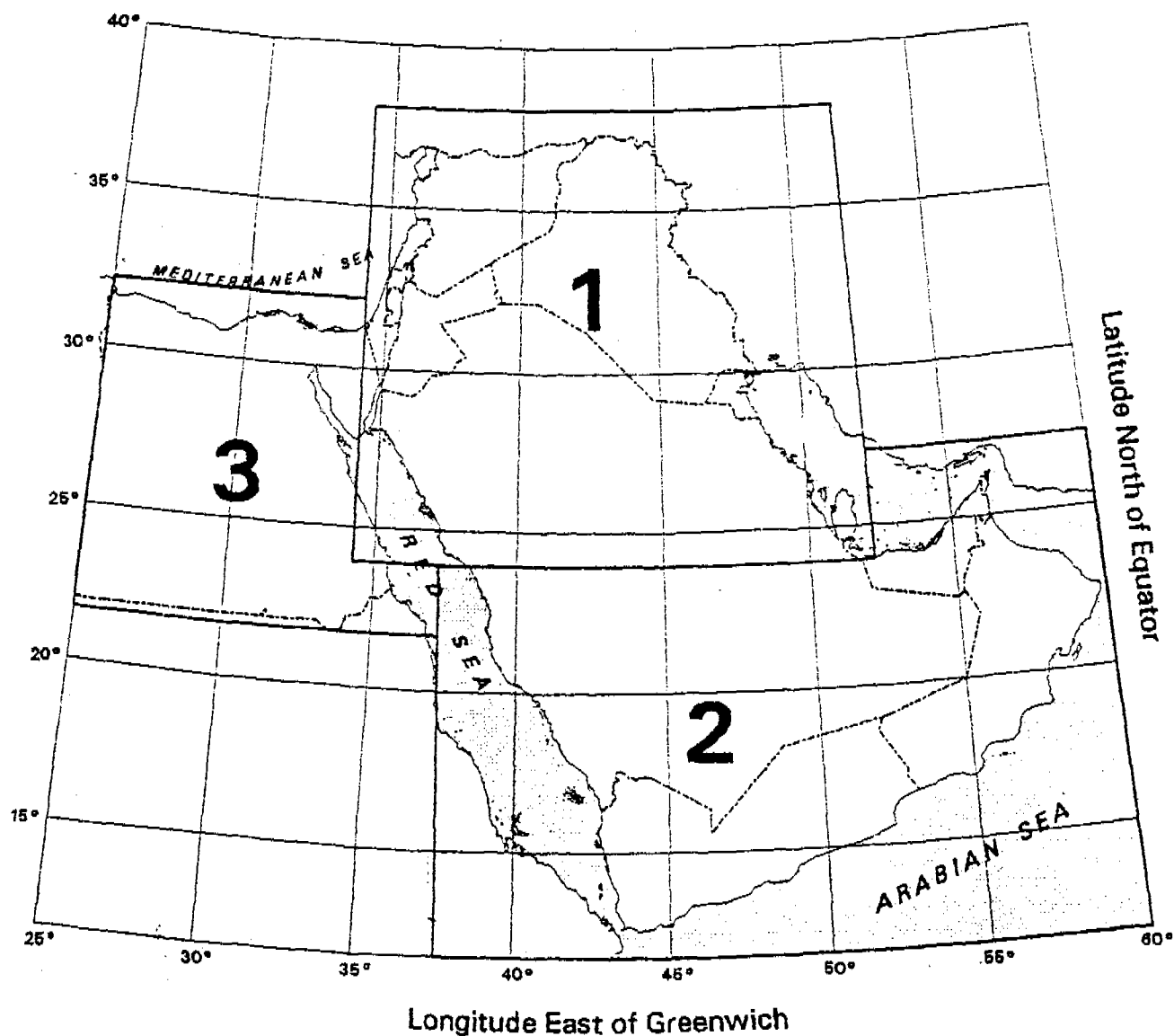
Basin	Aquifer system	Geology	Occurrence
GW1	East Mediterranean carbonate	Jurassic and Cenomanian-Turonian limestones/dolomites	Syrian Arab Republic, Lebanon and Jordan mountainous regions
GW2	Jabal el Arab basalt group	Miocene-Pleistocene basalts	Syrian Arab Republic, Jordan, Saudi Arabia volcanic plateau
GW3	Syrian desert	Cretaceous-Palaeogene marl and chalk	Syrian Arab Republic
GW4	Ghouta (Damascus) plain	Quaternary gravels	Syrian Arab Republic
GW5	Jezira Tertiary limestone	Middle Eocene-Oligocene limestones/dolomites	Syrian Arab Republic and Turkey
GW6	Jezira clastic	Neogene gravels	Syrian Arab Republic and Iraq
GW7	Jezira Lower Fars-Upper Fars	Miocene-Quaternary sandstones, sands and gravels	Syrian Arab Republic and Iraq
GW8	Mesopotamian alluvial	Miocene-Quaternary sands and sandstones	Iraq
GW9	Mesopotamian clastic	Pliocene-Quaternary sands and gravels	Iraq
GW10	Zagros carbonate	Mesozoic limestones	Iraq
GW11	Western Arabia sandstones	Ram/Saq-Fabuk Minjur Wajid	Jordan-Saudi Arabia Saudi Arabia Saudi Arabia-Yemen
GW12	Central Arabian Cretaceous	Aruma limestone; Biyadh-Wasia sandstones, Amman-Wadi Sir	Saudi Arabia-Iraq Saudi Arabia-Iraq-Kuwait, Jordan, Syrian Arab Republic
GW13	Eastern Arabia Tertiary carbonate	Neogene; Dammam and Umm-er-Radhuma limestones	Saudi Arabia, Kuwait, Iraq, Bahrain, Qatar, Oman, United Arab Emirates, Yemen, Syrian Arab Republic
GW14,15	Tihama/Aden alluvials	Quaternary sands and gravels	Saudi Arabia/Yemen
GW16	Yemen highlands	Tertiary-Quaternary volcanics	Yemen
GW17	West Oman Bajada	Quaternary alluvial fans and Fars limestone	Oman
GW18	Batinah alluvials	Quaternary sands and gravels	Oman
GW19	Nubian sandstone	Carboniferous-middle Cretaceous	Egypt, Libyan Arab Jamahiriya, Sudan, Chad
GW20	Nile Valley alluvials	Quaternary-Tertiary gravels	Egypt

Source: J. Khouri, "Hydrology and hydrogeology of the major basins and aquifer systems in the Mashrek, Arabian Peninsula and Nile Valley (Damascus, ACSAD, 1991).

(b) *Hydrogeological units:*

- (i) Karstic aquifers: limestones and dolomites receiving modern recharge and discharging in the form of large springs. Examples include the Jurassic and Cenomanian-Turonian of the Syrian Arab Republic, Lebanon, Iraq, Oman and South Yemen and the Amman-Wadi Sir in the western highlands of Jordan;
- (ii) Palaeokarstic aquifers: limestones and dolomites generally containing fossil water and receiving little modern recharge. Examples include the Umm-er-Radhuma and Dammam aquifers, which are mainly located in the eastern part of the Arabian Peninsula and the Gulf States;

**Figure I. Location of map sheets (1:2,500,000): regional hydrology and hydrogeology**



*The boundaries and names shown and the designations used on this map do not imply official endorsement or acceptance by the United Nations.*

- (iii) Local basin aquifers: mainly Miocene-Quaternary clastic sand aquifers, extensive in some regions and locally developed in others. Examples include the Tihama alluvial aquifers of Yemen and Saudi Arabia, the Wadi Araba and Jordan Valley alluvials in Jordan and the occupied territories, and the alluvials of the Euphrates and Tigris and the River Nile floodplain and Delta;
- (iv) Extensive basin aquifers of fossil origin and receiving little modern recharge: mainly the Ram/Saq Palaeozoic sandstones of Jordan and Saudi Arabia; the Palaeozoic-Mesozoic sandstones (Wajid, Minjur, Biyadh, Wasia) of Saudi Arabia; and the Carboniferous-middle Cretaceous Nubian sandstone of Egypt, Sudan, Chad and the Libyan Arab Jamahiriya;



- (v) Igneous rocks, mainly basaltic lavas, containing rechargeable groundwater in fissures and weathered zones. Examples include the Jebel el Arab basalt aquifer in the Syrian Arab Republic, Jordan and Saudi Arabia and the trap volcanics in Yemen;
- (vi) Local or discontinuous sedimentary aquifers. Generally, these have low to very low yields and are irregularly recharged. They comprise a variety of lithologies, including limestones, marly limestones, sandstones and alluvial sediments. Examples are the Aruma of Saudi Arabia, the Rijam of Jordan, and the Miocene-Quaternary clastics of the Mesopotamian plain.

## 2. Shared aquifer systems

Of the 20 aquifer systems delineated (see table 3), Khouri (1991) considered eight to be shared groundwater systems. One shared aquifer of political significance is the Cenomanian-Turonian limestones shared between the occupied territories and Israel.

The eight shared systems are described below (only the most basic information is provided for the first three, which are discussed in some detail in the paper entitled "Major shared groundwater basins in the ESCWA region: Hydrogeology and hydrochemistry," the remaining five receive more comprehensive coverage [based on the Khouri report, 1991]):

(a) *The Western Arabia sandstone aquifer system (GW11)* includes the Saq sandstone of Saudi Arabia and its equivalent the Ram sandstone of Jordan;

(b) *The Central Arabian cretaceous aquifer system (GW12)* is shared between Saudi Arabia, Kuwait, Jordan and Iraq, as represented by the Aruma limestones (Tayarat of Iraq), the Amman-Wadi Sir aquifer of Jordan, and its equivalent in the southern the Syrian Arab Republic;

(c) *The Eastern Arabia Tertiary carbonate aquifer system (GW13)* corresponds to the Umm-er-Radhuma and Dammam limestones and shared between Saudi Arabia, the Gulf States, Yemen, the Syrian Arab Republic and Iraq;

(d) *The East Mediterranean aquifer system (GW1)* is shared by the Syrian Arab Republic and Lebanon in the regions of the Alouite and Palmyran mountains in the Syrian Arab Republic, the Anti-Lebanon, and the Hermon mountains in the Syrian Arab Republic-Lebanon. The aquifer system also covers the Lebanon mountains and the western highlands of Jordan. The system is represented by karstic Jurassic and Cenomanian-Turonian limestones and dolomites that receive recharge by rainfall. Discharge is in the form of large springs with flows of up to 10 cubic metres per second ( $m^3/s$ ). Groundwater quality is good, ranging from 200 to 500 mg/l. Because the aquifer system exists in the form of more or less independent limestone massifs, recharge and discharge conditions and groundwater flow regimes are limited to individual nations and regions, which precludes an examination of groundwater transfers from one country to another;

(e) *The Jebel el Arab basaltic aquifer system (GW2)* comprises mainly basalts of the Miocene-Pleistocene stretching from the southern Syrian Arab Republic into Jordan and further southwards into Saudi Arabia. Though the thickness of the basalts ranges from less than 100 metres to more than 2,000 metres, the saturated aquifer thickness is generally small (50-100 metres). The aquifer owes its groundwater-bearing properties to fractures, cooling cracks and weathered horizons. It is therefore highly anisotropic, with transmissivities ranging from 10 square metres per day ( $m^2/d$ ) to about 25,000  $m^2/d$ . Because of its fractured nature, it is often discontinuously saturated. In the Syrian Arab Republic, Jordan and Saudi Arabia, it overlies Eocene Rijam limestones and younger formations, and locally, in north Jordan, the Cenomanian Amman limestones. Groundwater movement is northward towards the Damascus basin and south-south-

eastward towards northern Jordan and Azraq. It discharges in the form of springs near the Yarmouk River and in the Azraq area. Numerous springs, many of which are ephemeral, occur in the elevated, high rainfall area of the Jebel Druze. At present, it is exploited mainly in northern Azraq, where a well field abstracts approximately 13 million cubic metres (MCM) per year for the supply of the Jordanian capital city, Amman; as a result, the flow of the Azraq springs has decreased significantly from 16 MCM/year to less than 3 MCM/year. In the Jebel Druze area, spring flows augmented by boreholes are used for irrigation and domestic supply, though the quantities are not known. Recharge in the Syrian Arab Republic has been estimated at 270 MCM/year and discharge at 260 MCM/year. In Jordan, recharge in the basalts of the Azraq basin has been estimated at 24 MCM/year. All of these estimates are tentative and can only be confirmed by further study. Groundwater quality is generally good (200-500 mg/l), although in some locations figures can run as high as 2,000 mg/l. The development of the aquifer is hampered by extremely variable transmissivities, and in Jordan, by the need to maintain the existing spring flows which sustain the internationally known bird sanctuary at the Azraq Oasis;

(f) *Jejira Tertiary limestone aquifer system (GW5)* occurs in northern Jejira in the Syrian Arab Republic and extends into southern Turkey. It comprises Middle Eocene-Oligocene limestones and dolomites with a thickness of 200 to 300 metres in Turkey and about 600 metres in the Syrian Arab Republic; in the former, the outcropping aquifer is highly karstified, while in the latter, it is confined and locally artesian. Recharge occurs at outcrop, in Turkey, at an estimated rate of 1,600 MCM/year. Discharge occurs mainly via two large springs: Ras el Ain (1,261 MCM/year) and Ain el Arous (189 MCM/year). The balance of 150 MCM/year flows southward and leaks into the underlying gypsiferous Fars formation. The development of the aquifer by boreholes has reduced the flow of Ras el Ain to 160 MCM/year. Water quality is good (220-550 mg/l) but sulphurous; hot springs at Ras el Ain have dissolved solids of 800-2,000 mg/l. The development of the aquifer for irrigation in both Turkey and the Syrian Arab Republic has led to a 10% reduction in the flow of the Ras el Ain spring. However, recent drilling has shown the aquifer to be more extensive than previously thought;

(g) *The Jejira lower Fars-upper Fars aquifer system (GW7)* occupies the Mesopotamian plain of the Jejira of the Syrian Arab Republic and Iraq. The lower Fars comprises a fissured limestone aquifer and the upper Fars cemented sandstones. The latter are overlain by unconsolidated Quaternary sands. The aquifer is generally not very productive. It is recharged through rainfall, riverbed infiltration and irrigation returns. Recharge for parts of the aquifer is 185-215 MCM/year, while discharge is 30-60 MCM/year in the form of small springs. Other recharge estimates suggest that recharge amounts to 325 MCM/year; 55 MCM/year is derived from Iraq and the balance from the Syrian Arab Republic. Groundwater quality is poor (2,500 to 5,000 mg/l), which limits its utilization. Present development is for irrigation using shallow dug wells and deep tube wells; further development will depend on the potential of the deep aquifer;

(h) *The Nubian sandstone aquifer system (GW19)* is shared between Egypt, the Sudan, Chad and the Libyan Arab Jamahiriya. It consists of a thick sandstone layer (500-3,000 metres) of middle Cretaceous-Carboniferous age overlying the Precambrian basement. In detail, some sandstone aquifers are separated by clay-shale layers. Transmissivities range from 500 to 2,000 m<sup>2</sup>/d for screened intervals of approximately 200 metres. Permeabilities range from 1 to 200 metres/day (m/d) but average 10 m/d. The Nubian sandstone has been divided into eight sub-basins: one in Chad (Edas basin); one in the Libyan Arab Jamahiriya (Kufra basin); two in Egypt (Dakhla and Upper Nile platform); and four in Sudan. Modern day recharge is thought to occur in various regions of the Libyan Arab Jamahiriya and Sudan. In Egypt, recharge is from underflow. The bulk of the groundwater reserves are, however, of fossil origin and more than 8,000 years old. Groundwater moves to the north and north-west and discharges into major depressions, oases and sabkhas. Prior to exploitation, groundwater flow was in balance with discharge, estimated at 190 MCM/year. In the Libyan Arab Jamahiriya, over the last 30 years, there has been considerable development (which is still ongoing) for irrigation at Kufra. The Great Man-made River Project (under implementation) is intended to

convey some 300 MCM/year to the coastal region from well fields in Tazerbo. In Egypt, extraction totalled 392 MCM/year in 1982 (plus 30 MCM/year in Sinai). Groundwater quality is excellent—typically 100-200 mg/l (Kufra and Tazerbo). In the Kharga Oasis of Egypt, total dissolved solids are 130-800 mg/l, and in the Dakhla Oasis, 170-230 mg/l. In the northern regions (the Qattara depression) the groundwater becomes saline, with dissolved solids of more than 2,000 mg/l. At present, there is insufficient information to determine the effects of future abstraction on the sharing countries. However, intensive exploitation will probably affect the water supply and environmental integrity of the discharge areas in the various oases and sabkhas in the long term.

## References

- ACSAD, UNESCO AND IIGEE. 1988. Water resources assessment of the Arab region. Paris-Delft-Damascus. (ACSAD/HS/P66).
- Andrews, I. J. 1991. Palaeozoic lithostratigraphy in the subsurface of Jordan. NRA publication. Bulletin No. 2.
- Food and Agriculture Organization of the United Nations (FAO). 1979. Survey and evaluation of available data on shared water resources in the Gulf States and the Arabian Peninsula, vols. I, II and III. Rome.
- Italconsult. 1969. Water and agricultural development studies for Area IV, final report. Report for the Ministry of Agriculture and Water, Saudi Arabia.
- Khouri, J. 1991. Hydrology and hydrogeology of the major basins and aquifer systems in the Mashrek, Arabian Peninsula and Nile Valley. Damascus, ACSAD.
- Powers, R. W., and others. 1966. Geology of the Arabian Peninsula: sedimentary geology of Saudi Arabia. United States Geological Survey.

# XXI. MAJOR SHARED GROUNDWATER BASINS IN THE ESCWA REGION: HYDROGEOLOGY AND HYDROCHEMISTRY

by

*A.N. Charalambous\**

## *Abstract*

The present paper discusses the hydrogeology and hydrochemistry of three major shared groundwater basins in the ESCWA region: the Cambro-Ordovician Ram/Saq sandstone aquifer shared between Jordan and Saudi Arabia; the Upper Cretaceous-Palaeocene carbonate aquifer shared between Saudi Arabia, Iraq, Jordan and the Syrian Arab Republic; and the Eocene Dammam limestone aquifer shared between Saudi Arabia, Kuwait, Iraq, the United Arab Emirates, Qatar and Bahrain. The Ram/Saq sandstone is perhaps the most prolific aquifer of the Arabian Peninsula. The stored groundwater is of fossil origin with only minor modern replenishment. It is thought to discharge at or below sea level in the form of springs, mainly along the Dead Sea-Wadi Araba graben. At or near outcrop where it is mostly exploited, the Ram/Saq groundwater is of excellent chemical quality, but some mineralization probably occurs in the subsurface along the direction of groundwater flow. The Upper Cretaceous-Palaeocene carbonate aquifer system consists of two main aquifers: the Aruma and the Umm-er-Radhuma. The Aruma is generally a poor aquifer, except in Jordan, where it is represented by the rechargeable fissured limestones of the Amman-Wadi Sir Group. The Umm-er-Radhuma and the Dammam are the dominant aquifers of the eastern part of the Arabian Peninsula including Iraq. They are separated by the Rus anhydrite, which acts as an aquiclude. Both aquifers are of the palaeokarstic type. They are characterized by an eastward regional flow towards the Arabian Gulf, where they discharge in the form of onshore and subterranean springs. The existence of oases and sabkhas along the Gulf coastal zone reflect the groundwater resurgences from these aquifers. Though the groundwater is generally old, modern recharge at outcrop is thought to be responsible for sustaining present-day flow and hydraulic gradients. The groundwater from both aquifers is generally brackish, with mineralization increasing eastward along the direction of groundwater flow.

## **Introduction**

The present paper was prepared in fulfilment of the objectives of the UNEP/ESCWA project on "Assessment of water resources in the ESCWA region using remote-sensing techniques", and should be read in conjunction with the relevant hydrogeological maps (scale 1:1,000,000).

Its purpose is to provide a description of the hydrogeology, hydrochemistry and present status of three major groundwater basins shared by different countries in the ESCWA region. The paper does not purport to be an exhaustive study of the aquifers but rather a general overview based on published works.

### A. THE CAMBRO-ORDOVICIAN GROUNDWATER BASIN

#### 1. *Hydrogeology*

The major aquifer of the Cambro-Ordovician groundwater basin is the Saq sandstone of Saudi Arabia and its Jordanian equivalent, the Ram Group (previously known as the Disi Group). The aquifer rests on Precambrian basement and is overlain by a thick, multilayered succession of Ordovician-Silurian shales and

---

\* The author is the Director of Hydrogeological Services International Ltd., London.

fine sandstones, represented by the Tabuk formation of Saudi Arabia and the Khreim Group of Jordan. Although the Tabuk/Khreim can provide limited quantities of generally brackish water, as it is predominantly argillaceous, it forms the upper confining aquiclude to the aquifer. In western Jordan the Khreim Group is absent, and the Ram/Saq aquifer is in hydraulic continuity with the Lower Cretaceous Kurnub Sandstone but is confined by younger Cretaceous marl and marly limestones.

The Ram/Saq outcrop starts as a thin strip along the eastern margin of the Dead Sea and continues southward mainly east of the Wadi Araba-Dead Sea fault, broadening into the Qa Disi-Umm Sahn area of southern Jordan. It continues southward to Tabuk in Saudi Arabia as far as Tayma, where it swings eastward then finally to the south again as far as Qasim (in the central region). The outcrop covers an area of 66,000 square kilometres (km<sup>2</sup>) in Saudi Arabia and 3,000 km<sup>2</sup> in Jordan. Away from the outcrop, the system occurs throughout Saudi Arabia and Jordan at increasing depths of 1,000-3,000 metres. Its thickness ranges from 500 metres to more than 2,000 metres.

The aquifer is unconfined in the outcrop areas, becoming confined eastward beneath the Tabuk/Khreim shales and younger strata. Water levels in the unconfined section range from 50-150 metres below ground level (bgl) to more than 250 metres (bgl) in the topographically elevated areas. In the confined areas, artesian flowing conditions were reported in the Mudawwara area of Jordan in 1986 and in Tabuk in Saudi Arabia in the early 1980s. Piezometric heads range from 700 metres above sea level (asl) to more than 850 metres asl at outcrop; they decrease progressively north-eastward along the direction of groundwater flow to less than 700 metres asl in Saudi Arabia, 500 metres asl in Jordan, and less than 100 metres asl along the eastern margins of the Dead Sea.

In recent years, owing to intensive exploitation, cones of depression in the Ram/Saq aquifer have formed around Tabuk and Buraydah/Unayzah (both in Saudi Arabia). Since 1983, water levels in Tabuk have been depressed by as much as 160 metres in the centre and 20-50 metres in the periphery, and in Buraydah/Unayzah by more than 70 metres. In Jordan, significant exploitation since 1986 has led to a steady decline in water levels by 1-5 metres per year (m/y) in the confined section of the aquifer. In Saudi Arabia, water levels fall in the unconfined areas by around 2-6 m/y.

Piezometric data exist mainly for the areas within and close to the outcrop but are scanty for the most part. Thus, regional piezometry and directions of groundwater flow are somewhat conjectural and are based on the hydrogeological setting of the aquifer and on the not unreasonable premise that springs along the eastern margin of the Dead Sea originate primarily from the Ram/Saq aquifer. It appears, therefore, that groundwater flows from the unconfined areas of Jordan and Saudi Arabia in an easterly-north-easterly direction towards the Dead Sea, where it discharges in the form of springs at a rate of approximately 66 million cubic metres (MCM) per year. There appears to be a groundwater divide between Jubah and Buraydah: west of the divide, groundwater flows to the north towards Jordan, while the flow east of the divide is to the east-north-east. Values of permeability obtained from pumping tests and core analyses in Jordan and Saudi Arabia are similar, averaging between 0.3 metres per day and a maximum of 16 m/d. There appears to be no decrease in permeability with depth. Transmissivities vary from approximately 200-900 m<sup>2</sup>/d in the unconfined areas to more than 1,000 m<sup>2</sup>/d in the confined sections. Specific yields can vary from 1% to 20%, averaging perhaps 7% to 10%, while porosities range from 10% to 30%. Confined storage coefficients are in the order of 10<sup>3</sup> to 10<sup>4</sup>.

Exploitation of the aquifer is largely for irrigation, with only minor quantities used for municipal supply (Tabuk and Aqaba). Landsat imagery suggests that the total irrigated area in 1995 was 15,259 km<sup>2</sup> (1,529,900 hectares). Although there is a dearth of accurate estimates, it appears that Saudi Arabia extracts approximately 2,000 MCM/year, of which 650 MCM/year is from the Tabuk region. Jordan exploits about 75 MCM/year. Municipal supplies probably account for less than 20 MCM/year.

Isotope analyses suggest that the Ram/Saq groundwater is 10,000-40,000 years old and probably infiltrated in the late Pleistocene-Holocene, when rainfall was plentiful. With the onset of arid conditions in the last 3,000 to 4,000 years, rainfall has decreased to 40-60 mm/year, and modern recharge has thus become extremely small, probably amounting to 2 mm/year or less. On this basis, present day recharge in Saudi Arabia could be estimated at 130 MCM/year, and in Jordan at 6 MCM/year, representing only 6%-7% of current abstraction.

## 2. Hydrochemistry

### (a) Jordan

In Jordan the chemistry of the aquifer groundwater has largely been determined from boreholes in the southern desert in the unconfined and to a lesser extent in the confined areas, and from the springs in the Dead Sea area. In general, the groundwater is of the bicarbonate type, becoming richer in chloride and sulphate but also in bicarbonate as they move eastward in the confined area. Total dissolved solids are low at 200-250 milligrams per litre (mg/l) in the Qa Disi and Mudawwara areas, but increase progressively eastward along the direction of groundwater flow to 400-500 mg/l. The pH is generally in the acid to neutral range (6.5 to 7) in the unconfined section, becoming alkaline to the east (7.2 to 7.5). In the Dead Sea area, the groundwater emerging from the springs is generally mineralized, with total dissolved solids in the range of 1,000 to 3,000 mg/l, and have high temperatures (31° C to 45° C). The high temperatures are related to high geothermal gradients associated with the Rift. The mineralization is probably a function of residence time in the aquifer.

### (b) Saudi Arabia

Total dissolved solids in the Tabuk and Tayma areas range from 150 to 970 mg/l, with an arithmetic average of 320 mg/l. Higher concentrations averaging 1,200 mg/l have been reported in Al Qasim. The groundwater in Tabuk and Tayma is richer in sulphate and chloride than those in Jordan, but this may reflect the fact that many of the boreholes abstract from both the Saq and the overlying brackish Tabuk/Khreim sandstones. In the Tabuk Agricultural Company well field, electrical conductivity measurements have not indicated any deterioration in groundwater quality; here, electrical conductivities range from 550 to 1,000  $\mu\text{S}/\text{cm}$  at 25° C.

Where the aquifer is exploited, water quality is generally excellent for both municipal and agricultural purposes. In the deeply confined areas, mineralization has probably occurred, albeit on a small scale, owing to the mainly quartzite nature of the aquifer; however, in the absence of data, this cannot be known with certainty.

## B. THE UPPER CRETACEOUS-PALAEOCENE CARBONATE AQUIFER SYSTEM

### 1. Hydrogeology

The aquifer system comprises the Upper Cretaceous Aruma formation of Saudi Arabia and its equivalent in Jordan (Amman-Wadi Sir) and in Iraq (Tayarat) and the Palaeocene Umm-er-Radhuma formation of the Arabian Peninsula including Iraq. The Palaeocene of Jordan is represented by a bituminous marly sequence (the Muwaqqar formation) and is thus non-aquiferous.

The Aruma and Umm-er-Radhuma aquifers outcrop in an almost continuous, relatively broad arcuate strip parallel to the Central Arabian Arch and extend from Iraq in the north to the Rub' al Khali in the south. In Jordan, the Amman-Wadi Sir outcrops in the western highlands and in the southern escarpment. Elsewhere, the aquifers occur at depths beneath Palaeogene, Neogene and younger strata.

In the Arabian Peninsula, the Aruma is hydraulically connected to the Wasia sandstone aquifer below and the Umm-er-Radhuma aquifer above, the top of the Aruma being generally represented by a thin, blue-grey to black dolomite shale. In west Jordan, the base of the Amman-Wadi Sir is defined by the lower Ajlun marl aquiclude and the top by the Muwaqqar marl aquiclude. In south Jordan (El Jafr basin), the aquifer grades into the sandy facies of the Fassua and the Lower Cretaceous Kurnub sandstone, a situation similar to that in Saudi Arabia. The top of the Umm-er-Radhuma is defined by the Rus anhydrite aquiclude which separates it from the overlying Dammam aquifer.

(a) *The Aruma aquifer*

In Saudi Arabia, the Aruma comprises massive limestones 400-600 metres thick, partly dolomitized and locally fissured, with interbedded shales and marl. In the Rub' al Khali and north-west Saudi Arabia, sandy facies predominate. In Jordan, the Amman-Wadi Sir is generally 100-200 metres thick and consists of fissured limestones and sandy limestones. The limits of saturation of the aquifer are not well known, but it is suspected that it may be discontinuously saturated or unsaturated in easternmost Jordan, in westernmost Iraq and the adjoining region of Saudi Arabia, and in southern Jordan. In Saudi Arabia it is considered to be a minor aquifer and little exploited, but in Jordan it constitutes one of the major groundwater sources of the country, with an output of 213 MCM/year, representing 43% of the total groundwater extraction.

In the Arabian Peninsula and Iraq, groundwater movement is generally to the east; Piezometric elevations in the outcropping western area range from 300 to 450 metres asl, falling to 200 metres asl along the Gulf coast and the Euphrates. In the western highlands of Jordan, there are a number of groundwater mounds from which flow radiates eastward to the confined eastern desert areas. There appears to be regional tendency for flow to converge into the Azraq basin, except in the very north, where flow is northward into the Yarmouk River.

Because of the aquifer's fissured nature, permeabilities vary widely (0.005-200 m/d). In Jordan, transmissivities range from as little as 10 m<sup>2</sup>/d to as high as 7,500 m<sup>2</sup>/d, with an average of 500 m<sup>2</sup>/d. Specific yields are probably 0.5% to 3%, while confined storage coefficients are 10<sup>-3</sup> to 10<sup>-4</sup>.

This aquifer receives modern recharge in the western highlands of Jordan, where rainfall can be as high as 600 mm/year. Much of the recharged water, approximately 325 MCM/year, discharges throughout in numerous small and large springs. In the Arabian Peninsula, southern Jordan and Iraq, rainfall is significantly lower, generally less than 100 mm/year, so the magnitude of modern recharge is small. Isotope analyses indicate the existence of old groundwater in the confined areas.

(b) *The Umm-er-Radhuma aquifer*

The Umm-er-Radhuma is a significant aquifer in the Arabian Peninsula and has been developed mainly in Saudi Arabia, Kuwait and Iraq, and also in Qatar and Bahrain. The aquifer has a thickness of 100-600 metres and consists of limestone, dolomite and calcarenitic limestone, except in the extreme north-east, where argillaceous limestones with anhydrite layers predominate. The water-bearing characteristics of the Umm-er-Radhuma are mainly from joints, fissures and solution voids. Fissures are normally associated with anticlinal structures (such as the Ghawar anticline) and solution voids with dolomitization processes. Palaeokarstic features (swallow holes and caverns) occur at outcrop and in the subsurface, as evidenced by losses in the circulation zones during drilling. Thus, well yields are variable, ranging from less than 5 litres per second (l/s) to more than 90 l/s. Similarly, transmissivities range from 5 m<sup>2</sup>/d to more than 55,000 m<sup>2</sup>/d, though in Kuwait they are less than 50 m<sup>2</sup>/d owing to increases in shale deposit content. Permeabilities range from 0.01 m/d to more than 400 m/d, specific yields from 0.2% to 7% (on average), and confined storage coefficients from 10<sup>-3</sup> to 10<sup>-5</sup>.



Groundwater movement is from the outcrop in the west-south-west to the Gulf and the Euphrates in the east. In the Rub' al Khali groundwater moves northward from Yemen. Piezometric elevations are highest in the outcrop, at 200-400 metres asl, falling to 25-50 metres asl along the Euphrates and the Gulf coast and to 5 metres asl in Bahrain. There is a tripartite zonation of hydraulic gradients similar to that of the overlying Dammam aquifer which is thought to be the result of groundwater discharges into sabkhas and springs. Thus, in general, hydraulic gradients at outcrop are 0.005, then, moving eastward, becoming flatter (0.0002) in the centre, in the area of the sabkhas, and steepening again (0.0015) along the coast. Water levels are relatively deep in the outcrop areas (100-200 metres bgl) but are above ground (artesian flowing) in the coastal region.

Environmental isotope determinations of groundwater age in Saudi Arabia have indicated a significant tritium content (3 to 10 tritium units [TU]) at or near outcrop areas, suggesting the occurrence of modern recharge. Carbon dating has indicated the presence of fossil waters in the confined areas, with a progressive increase in age (10,000-28,000 years) from west to east along the direction of regional groundwater flow. Present thinking is that modern recharge from rainfall and leakage from underlying and overlying strata amounts to 1,272 MCM/year and is responsible for maintaining the observed hydraulic gradients and in balance with the outflow to sabkhas and springs. These discharges amount to 1,311 MCM/year: 158 MCM/year through water-table evaporation, 285 MCM/year through land spring discharge, 13 MCM/year through offshore spring discharge, and 855 MCM/year through sabkha discharge.

The Umm-er-Radhuma is mainly exploited via boreholes in Saudi Arabia for the public supply in Dhahran (26 MCM/year) and in Bahrain (8 MCM/year). In Qatar, Kuwait, Iraq and the United Arab Emirates the aquifer is not exploited, mainly owing to poor water quality.

## *2. Hydrochemistry*

In Saudi Arabia and Iraq, the Aruma groundwater is brackish, with TDS concentrations of more than 1,500 mg/l; chloride, sulphate and sodium predominate. In Jordan, TDS is 500-1,000 mg/l in the recharge area of the western highlands, where groundwater is usually of the calcium bicarbonate type. Concentrations increase eastward in the direction of groundwater flow to 2,000-5,000 mg/l, accompanied by an increase in sulphate, chloride and sodium.

In the Umm-er-Radhuma aquifer, the TDS concentration increases eastward in the direction of groundwater flow. In the southern part of eastern Saudi Arabia (the Rub' al Khali), TDS increases northward from less than 1,000 mg/l to about 3,000 mg/l. In the central part of the Rub' al Khali, TDS is less than 1,500 mg/l in the west (outcrop areas), increasing to more than 3,000 mg/l in the coastal region. Along the Gulf coast the TDS concentration is higher than 5,000 mg/l, reaching more than 20,000 mg/l in Qatar and 40,000 mg/l in Bahrain. In Kuwait, TDS is generally greater than 5,000 mg/l. In Iraq, where the aquifer outcrops, TDS is 500 mg/l in the west, increasing to about 3,000 mg/l eastward and to more than 5,000 mg/l in the vicinity of the Euphrates. Within this broad pattern there are areas of high and low salinities which probably reflect preferential paths of groundwater flow, local aquifer mineralogy and the distribution of the Rus anhydrite. In terms of hydrochemical types, bicarbonate groundwater is rare, the dominating ion in the recharge (unconfined) areas being sulphate. In the discharge areas (sabkha zones), sodium chloride predominates at the expense of sulphate. Down-gradient in the sabkha zones, groundwater becomes of the chloride type, possibly owing to sea-water intrusion in past times.

## C. THE DAMMAM AQUIFER GROUNDWATER BASIN

### 1. *Hydrogeology*

The Dammam (Lower-Middle Eocene) aquifer comprises the following members: the Alat limestone underlain by a thin, reddish-brown marl; the Khobar limestone and marl; the Alveolina limestone; and the Saila/Midra shales. The Alat and Khobar carbonate members constitute the aquifer, while the underlying Saila/Midra shales, together with the Rus anhydrite, form the basal aquiclude/aquitard. At outcrop, the Dammam occurs in a narrow strip in the Eastern Province of Saudi Arabia, in the Rub' al Khali, and in anticlinal folds along the Gulf coast, in Qatar and Bahrain. The thickness of the Alat and Khobar members ranges between 50 and 250 metres and that of the Alveolina limestone and Saila/Midra shale members from 5 to 25 metres. The aquifer owes its water-bearing properties to joints, fissures and solution cavities of Palaeokarstic origin. However, in the United Arab Emirates it becomes argillaceous and is thus a poor aquifer.

Static water levels are generally below the surface in the west (50-150 metres bgl) but above the land surface along the coastal belt, where the aquifer is artesian flowing. In the Hasa and Qatif oases in Saudi Arabia, water levels are near or above the ground surface. Water levels along the coast do not appear to have significantly declined in recent years.

Piezometric elevations are 222-250 metres asl in the west, decreasing to less than 25 metres asl near sea level along the coast and the Euphrates. Regional groundwater flow in Iraq and the northern part of the Arabian Peninsula is to the east-north-east towards the Euphrates and the Gulf. In the Rub' al Khali, groundwater moves north to the United Arab Emirates. Kuwait and probably southern Qatar receive underflow from Saudi Arabia. Groundwater occurrence in northern Qatar and Bahrain is probably the result of a rainfall-fed freshwater lens.

Transmissivities and permeabilities are variable, reflecting the fissured (and locally the karstic) nature of the limestones. Transmissivities range from a few m<sup>2</sup>/d to as high as 25,000 m<sup>2</sup>/d, and permeabilities vary from 0.05 m/d to 150 m/d. Storage coefficients range from 10<sup>-3</sup> to 10<sup>-4</sup>, and specific yields average around 1%-3%. Groundwater discharges by upward leakage into the Neogene strata; laterally into the sabkha zone, which stretches from the central Rub' al Khali in the south to Kuwait in the north; and via onshore and submarine springs. Major springs occur in the Hasa and Qatif oases of Saudi Arabia, near the Euphrates in Iraq, in Bahrain, and in the tidal shallows of the Gulf. In Bahrain, spring flows decreased from 42 MCM/year in 1953 to 8 MCM/year in 1980, while recharge from submarine springs around the island fell from 13 MCM/year in 1952 to 6 MCM/year in 1980. In Iraq, near the Euphrates, spring discharges amount to 50-90 MCM/year. Spring flows into the sabkhas are difficult to evaluate owing to their diffused nature.

Historically, the aquifer has been exploited for irrigation in the Hasa and Qatif oases by hand-dug wells and from springs. In 1949, extraction by boreholes along the coastal belt was 352 MCM/year; 196 MCM/year was used for agriculture and the balance was for municipal and industrial use in the cities of Dammam and Khobar. In 1985, total abstraction was 250 MCM/year from more than 1,000 wells. In Qatar, abstraction from the Dammam and Umm-er-Radhuma was 109 MCM/year in 1990, in Bahrain 130 MCM/year (1990), and in Kuwait approximately 24 MCM/year (1994).

Recharge to the aquifer comes partly from rainfall infiltration but is mainly from upward leakage from the underlying Umm-er-Radhuma aquifer. Because the outcrop is relatively narrow, the amount of recharge from rainfall is small; estimates in Saudi Arabia suggest around 22 MCM/year.

## 2. *Hydrochemistry*

In general, salinity increases eastward in the direction of groundwater flow from 1,000-3,000 mg/l in the west to between 5,000 mg/l and more than 10,000 mg/l along the Gulf coast and the Euphrates. Chemical analyses of the Alat, Khobar and other members of the Dammam aquifer in Saudi Arabia show that all of them contain similar groundwater. Electrical conductivities from more than 900 samples indicate a mean value of about 4,000  $\mu\text{S}/\text{cm}$ , with minimum and maximum values ranging from 1,300  $\mu\text{S}/\text{cm}$  to more than 24,000  $\mu\text{S}/\text{cm}$ . Similarly, TDS concentrations of more than 1,000 samples suggest a mean value of 2,600  $\mu\text{S}/\text{cm}$ , with minimum and maximum values of 700 mg/l and 13,500 mg/l. In Kuwait, salinities range from 2,500 to 5,000 mg/l. Thus, the Dammam groundwater is on the whole brackish. Sodium and chloride are the main ions in the brackish groundwater, but calcium becomes dominant as mineralization increases.

## XXII. THE POTENTIAL FEASIBILITY OF DEVELOPMENT AND MANAGEMENT STRATEGIES FOR THE MAJOR GROUNDWATER BASINS OF THE ESCWA REGION

by

A.N. Charalambous\*

### *Abstract*

The three major shared groundwater basins discussed include: the Cambro-Ordovician Ram/Saq sandstone aquifer shared between Jordan and Saudi Arabia; the Upper Cretaceous-Palaeocene Aruma and Umm-er-Radhuma carbonate aquifer shared between Saudi Arabia and most of the other Gulf States, Iraq, Jordan and the Syrian Arab Republic; and the Eocene Dammam limestone aquifer shared between Saudi Arabia, Kuwait, Iraq, the United Arab Emirates, Qatar and Bahrain. The groundwater of all three basins is old (10,000-40,000 years). Modern recharge under present-day arid-semi-arid climatic conditions is small and, at most, is only able to maintain hydraulic gradients which were established many thousands of years ago, when conditions were more humid. Therefore, exploitation has to rely largely on storage resources and often exceeds the meagre recharge, which in the long term it is likely to upset the existing hydraulic regime, with consequent serious environmental effects on historic outflows in sabkhas, oases and springs. Resource management strategies should thus aim at balancing present human needs for development against maintaining the integrity of the resources and avoiding irreparable damage to the environmental value of oases, sabkhas and other areas of groundwater resurgences. In the case of shared aquifers, there is, of course, the additional issue of derogation when large extractions by one country adversely affect the resources of its neighbour. Though such issues can be addressed to a reasonable degree on a technical level, political, economic and legislative considerations are often crucial and require intergovernmental agreements pertaining to the allocation of resources. The present paper concentrates on the technical aspects by highlighting, on the one hand, the finite nature of the resources, and on the other hand, the importance of an integrated approach among the sharing countries in data gathering and processing, monitoring and exploration.

### **Introduction**

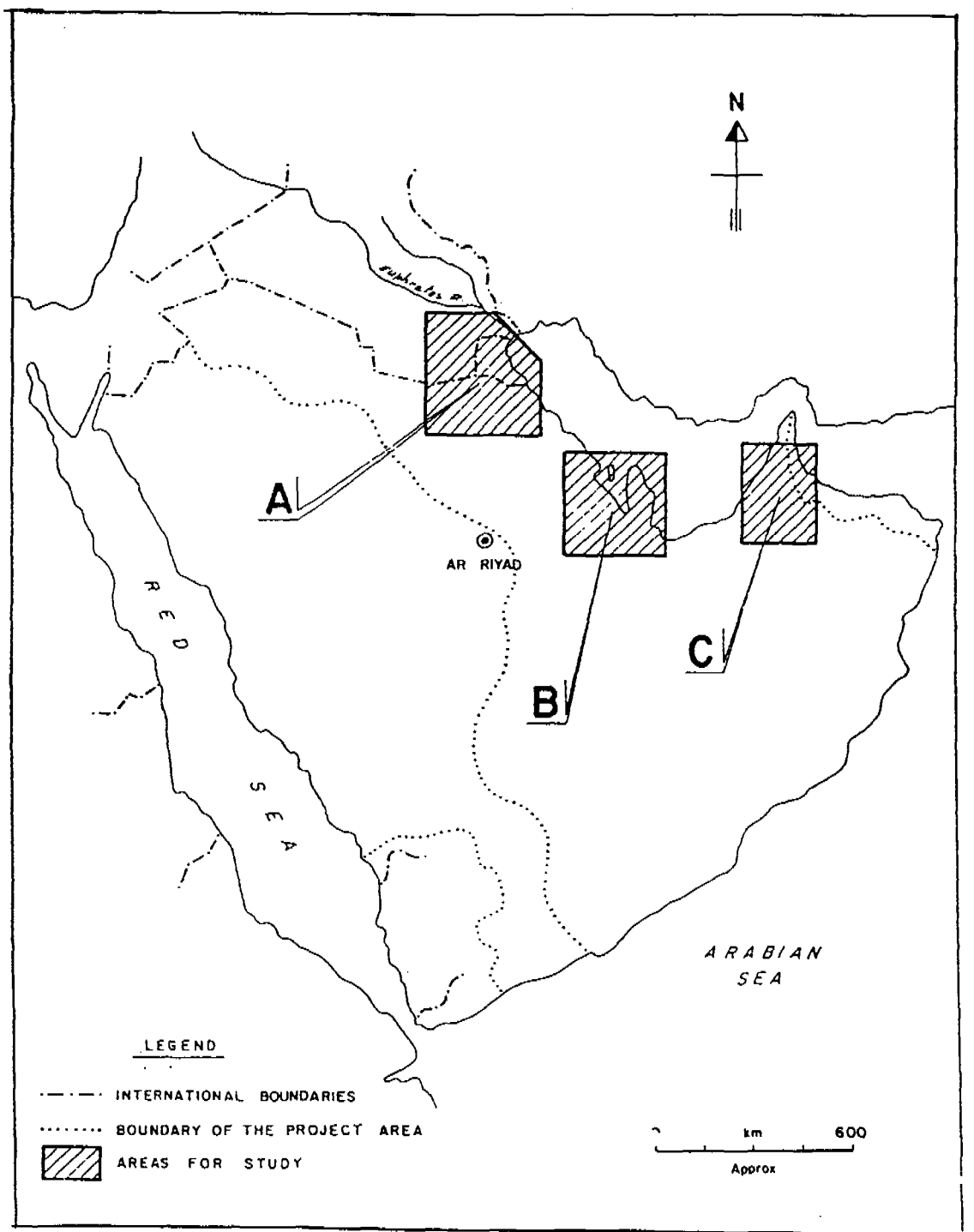
The question of the joint development and management, monitoring and exploration of shared aquifers by the sharing countries was first addressed by the Food and Agriculture Organization of the United Nations in its 1979 *Survey and Evaluation of Available Data on Shared Water Resources in the Gulf States and the Arabian Peninsula*. The FAO *Survey* stressed that additional water resource studies were required in three areas (see areas A, B and C in figure 1), all with reference to the Upper Cretaceous-Neogene aquifers. Area A covers Kuwait and adjacent Iraq and Saudi Arabia; area B covers Qatar, Bahrain and the adjacent coastal region of Saudi Arabia; and area C includes the United Arab Emirates, Oman and adjacent Saudi Arabia. In 1981, the Economic Commission for Western Asia (ESCWA), in its assessment of water resources in the ESCWA region, made a number of recommendations and proposed actions of the national, regional and subregional levels, stressing the need to establish a regional water resources council.

Despite numerous efforts, the various sharing countries have, in general, failed to develop a joint approach to water resources. While this may be understandable, given the diversity of water resources, conditions and economic and political constraints, some serious effort is required, especially with regard to some of the more important shared aquifers.

---

\* The author is the Director of Hydrogeological Services International Ltd., London.

Figure I. Map showing proposed area for study



The boundaries and names shown and the designations used on this map do not imply official endorsement or acceptance by the United Nations.

Source: FAO, *Survey and Evaluation of Available Data on Shared Water Resources in the Gulf States and the Arabian Peninsula*, vol. I (Rome, 1979).

## A. THE CAMBRO-ORDOVICIAN GROUNDWATER BASIN

### 1. *Development and management*

In 1993, Jordan abstracted some 75 million cubic metres (MCM)/year from the Qa Disi-Mudawwara area, while Saudi Arabia abstracted around 650 MCM/year from the Tabuk area. Total abstraction from the basin is around 2,000 MCM/year. Jordan is planning to abstract an additional 80 MCM/year for the supply of the capital city, Amman. Although the Ram/Saq aquifer constitutes a huge groundwater reserve, present exploitation far exceeds the very small recharge, so virtually all of the groundwater is mined from storage. Compared with the other two major carbonate shared aquifers, the Ram/Saq has the distinct advantage of good water quality (a potable supply), high-yielding boreholes, and generally uniform productivity. The present exploitation—mainly for the irrigation of desert areas in a region of the Middle East where water is at a premium—should be viewed with considerable scepticism. A change in policy is needed which aims at directing the use of the Ram/Saq groundwater for the potable supply. Action must be taken as soon as possible; the present situation must be remedied and a more prudent position sought which in the long term will be beneficial for both countries.

As the situation may soon become critical, it is recommended that a joint Saudi Arabian - Jordanian Committee be formed to address the main issue of water utilization. As a first step, a moratorium should be placed on all future extraction for irrigation. Second, a programme should be instituted for reducing (over, say, a period of 20 years) all irrigation abstractions to sustainable levels compatible with the utilization of the aquifer for potable supply. The sustainable development of the aquifer should be defined by further investigation and regional modelling. A tentative rate of sustainable abstraction in the Tabuk region of Saudi Arabia and in Jordan might be about 400 MCM/year. At this rate of exploitation, it should be possible to maintain reasonable abstraction levels for 50 years or perhaps more within economic pumping lifts of 200-250 metres bgl.

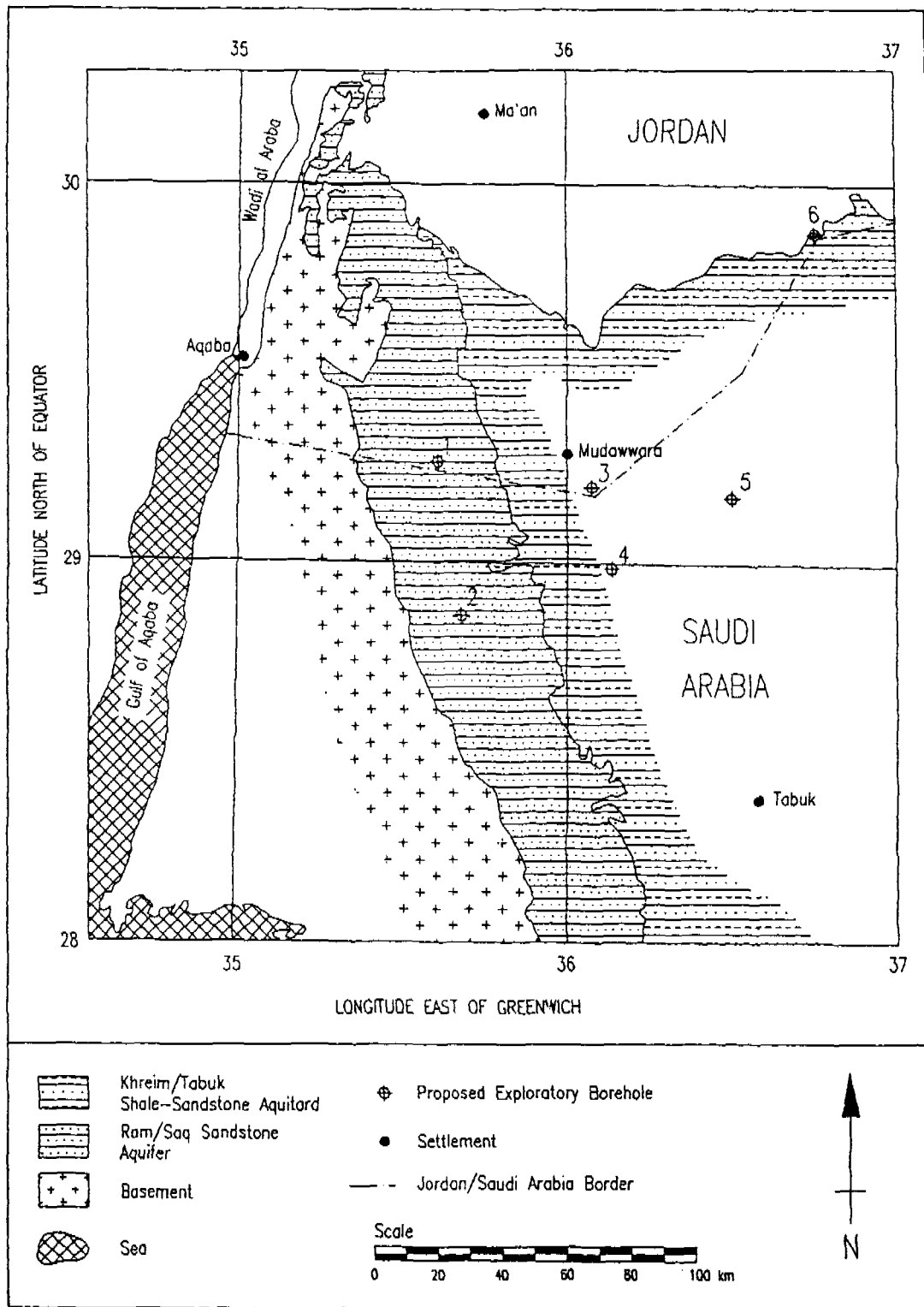
### 2. *Monitoring, exploration and investigation*

The Jordanian and Saudi Arabian authorities are currently monitoring water levels in their respective areas of exploitation. However, monitoring boreholes need to be constructed away from the centres of abstraction in order to define the regional effects on the groundwater regime. The proposed boreholes should also be used for exploration, for better defining piezometry, and for carrying out pumping tests to estimate transmissivity and storage coefficients. Six such boreholes are recommended, located as shown in figure II. All of the locations selected lie between the Tabuk region and the southern Jordanian border. Boreholes 1 and 2 should provide information on aquifer behaviour in the unconfined section of the aquifer; boreholes 3, 4 and 6 do the same for the confined areas. Approximate depths, together with grid references and elevations, are given in table 1.

### 3. *Groundwater modelling*

Although a number of individual groundwater models have been constructed by each of the sharing countries, a single joint model is proposed which takes into account the results of the recommended exploration but also reliable and accepted data from both countries. The model should be two-layered to simulate the influence of the Khreim/Tabuk aquitard.

**Figure II. Proposed exploration of the Cambro-Ordovician shared aquifer in Jordan and Saudi Arabia**



*The boundaries and names shown and the designations used on this map do not imply official endorsement or acceptance by the United Nations.*

TABLE 1. PROPOSED EXPLORATORY BOREHOLES IN THE RAM/SAQ AQUIFER

Borehole number	Coordinates		Elevation (metres above sea level)	Borehole depth (metres)	Depth to aquifer (metres)
	Latitude (North)	Longitude (East)			
1	29°16'	35°39'	1 200	400	ground level
2	28°52'	35°42'	1 200	400	ground level
3	29°11'	36°05'	760	650	250
4	29°00'	36°88'	750	750	300
5	29°10'	36°30'	750	2 000	1 500
6	29°53'	36°45'	1 000	2 100	1 700

## B. THE DAMMAM AQUIFER

### 1. *Development and management*

The Dammam aquifer is little known in the Rub'al-Khali and in the United Arab Emirates, but it is fairly well delineated in the rest of the Arabian Peninsula, Kuwait, Qatar, and recently, through exploratory drilling, in south-west Iraq. The consensus of opinion is that, owing to natural outflows in the sabkha zones and from onshore and offshore springs along the Gulf coast, exploitation in eastern Saudi Arabia is unlikely to affect Bahrain. The same can be said for northern Qatar, although southern Qatar may receive some underflow from Saudi Arabia. Groundwater flow in Iraq appears to be independent from Saudi Arabia and Kuwait; however, intensive exploitation in the border areas is likely to affect the three sharing countries. Moreover, further development of the aquifer along the coastal region and especially in the Qatif oasis might cause sea salt-water intrusion and the upward movement of mineralized groundwater from the deeper aquifers. At present, it appears that, as long as the current situation is maintained, no special management measures are required.

Although information is scanty, it appears that the United Arab Emirates receives underflow from Saudi Arabia. In the absence of data, it is not possible to estimate quantities of flow. However, geological information suggests that the Dammam in the United Arab Emirates is a poor aquifer owing to the argillaceous nature of the limestones; it is also likely that the groundwater is brackish or highly saline. Very little information is available; it is not possible to make any recommendations on groundwater development without further investigation.

### 2. *Exploration and monitoring*

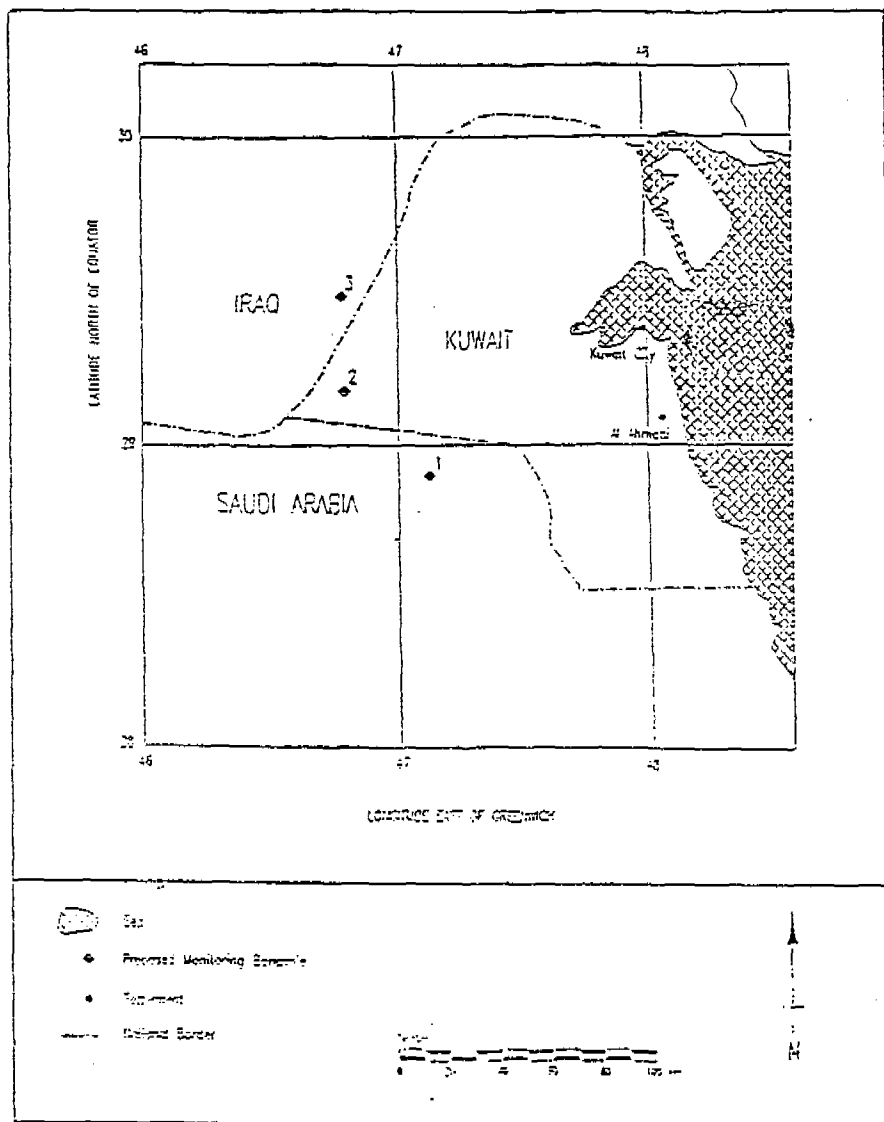
In the report by FAO (1979), two areas were recommended for further water resources study: Area A covering the Saudi Arabia-Kuwait-Iraq border regions; and Area C, comprising the United Arab Emirates, and Saudi Arabia. Existing information on the former, though far from perfect, is sufficient not to warrant further investigation, especially in the light of its very poor water quality (3,000 to more than 10,000 milligrams per litre [mg/l]). However, observation boreholes should perhaps be established in due course when the political situation becomes more stable. This would allow for the monitoring of water levels and water quality, which would be useful if any of the three sharing countries decide to increase abstraction. Three such boreholes are proposed, one in each country, as shown in figure III and table 2.



TABLE 2. PROPOSED EXPLORATORY BOREHOLES IN THE DAMMAM AQUIFER  
IN THE BORDER REGION OF KUWAIT, SAUDI ARABIA AND IRAQ

Borehole Number	Coordinates		Elevation (metres above sea level)	Borehole depth (metres)	Depth to aquifer (metres)
	Latitude (North)	Longitude (East)			
1	28°53'	47°10'	225	425	200
2	29°10'	46°50'	250	450	175
3	29°28'	46°49'	225	475	175

Figure III. Proposed locations for monitoring boreholes of the Dammam shared aquifer in Kuwait, Iraq and Saudi Arabia



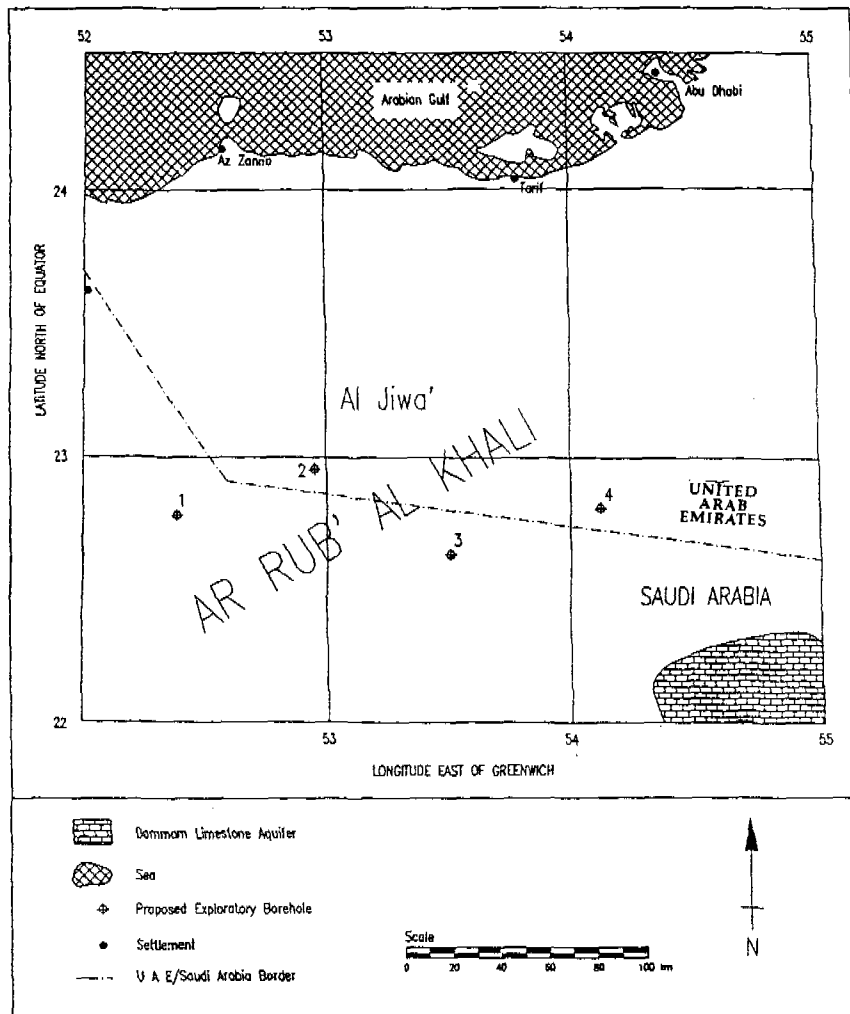
The boundaries and names shown and the designations used on this map do not imply official endorsement or acceptance by the United Nations.

As regards the United Arab Emirates-Saudi Arabia region, the general opinion is that it is a poor aquifer containing brackish-saline water. For this reason, investigations need not be comprehensive. Four exploratory boreholes are recommended, two in the United Arab Emirates and two in Saudi Arabia, as shown in table 3 and figure IV.

TABLE 3. PROPOSED EXPLORATORY BOREHOLES IN THE DAMMAM AQUIFER IN THE BORDER REGION OF SAUDI ARABIA AND THE UNITED ARAB EMIRATES

Borehole number	Coordinates		Elevation (metres above sea level)	Borehole depth (metres)	Depth to aquifer (metres)
	Latitude (North)	Longitude (East)			
1	22°44'	52°23'	120	620	470
2	22°57'	52°56'	140	690	440
3	22°37'	53°29'	160	710	485
4	22°48'	54°06'	160	660	510

Figure IV. Proposed exploration of the Dammam shared aquifer in the United Arab Emirates and Saudi Arabia



The boundaries and names shown and the designations used on this map do not imply official endorsement or acceptance by the United Nations.

## C. THE CRETACEOUS-PALAEOCENE CARBONATE AQUIFER

### 1. *The Palaeocene Umm-er-Radhuma limestone aquifer*

#### (a) *Development and management*

The Umm-er-Radhuma aquifer occurs in eastern Saudi Arabia, extending eastward into Qatar and Bahrain and northward into Kuwait and Iraq. In Jordan and the Syrian Arab Republic the facies change from limestone/dolomite to marls and chalky limestones and therefore have poor water-yielding properties. Exploitation of the aquifer is mainly in Saudi Arabia and Bahrain. It is not exploited in Qatar and Kuwait owing to very poor water quality; for the same reason, abstractions in Iraq appear to be small. The aquifer is thought to be hydraulically connected to the Dammam and Neogene aquifers above. In eastern Saudi Arabia, plans were put forward to use Umm-er-Radhuma groundwaters to irrigate some 33,000 hectares along the coastal region from Wadi Al Miyah in the north to Jabrin in the south. There is little doubt that the aquifer in this area is intensively exploited and that further development is rising. Because the Umm-er-Radhuma is hydraulically connected to the aquifers above, which discharge into sabkhas and oases, its exploitation may affect the stability of the overall hydrogeological system, especially in southern Qatar. It is believed that the aquifer along the coastal belt cannot be further developed. Management plans to limit abstraction may be needed to prevent any detrimental environmental effects on the oases and sabkhas.

Present exploitation in Kuwait, Iraq and northern Saudi Arabia, is not known. Plans for development will need to be preceded by investigations to better define the hydrogeological regime and the extent of sharing between the countries.

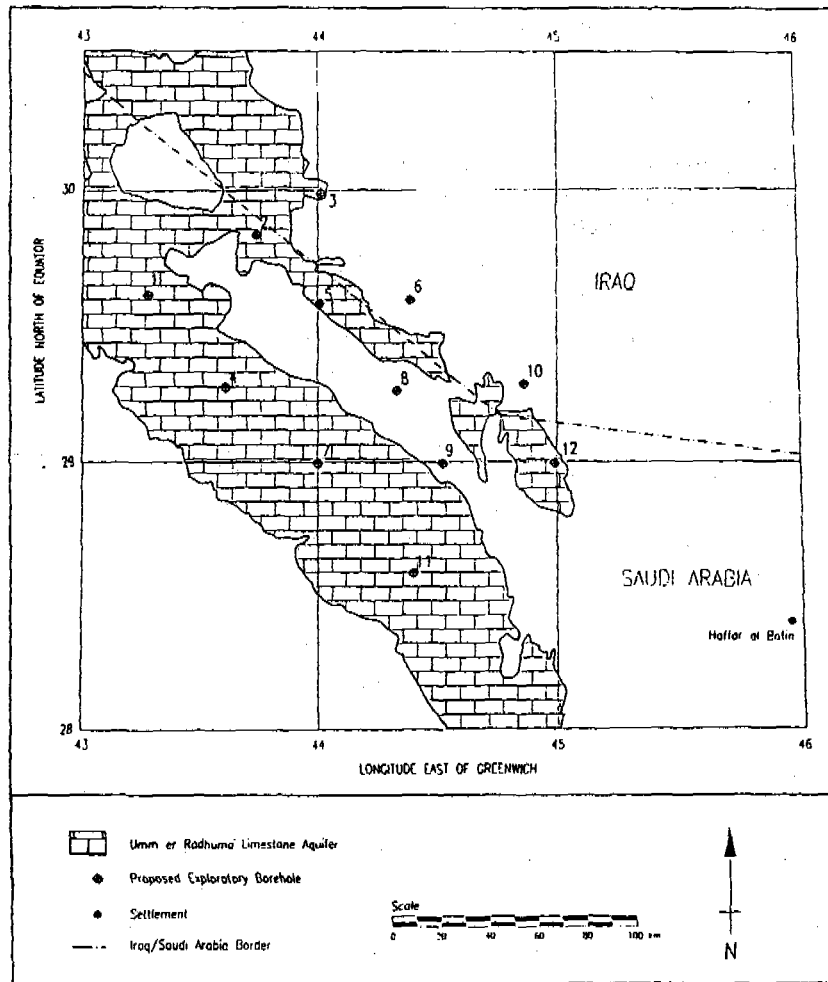
#### (b) *Exploration and monitoring*

From an aquifer-sharing standpoint, the outcrop areas between Saudi Arabia and Iraq are of significance. Here, the general hydrogeology indicates the movement of groundwater from Saudi Arabia into Iraq. As the aquifer outcrops in both countries, recharge must occur in both, though the Saudi Arabian outcrop is much larger. Information on the general area is scanty, and there is a need to define saturation limits, piezometry and hydraulic properties. Twelve boreholes are recommended for exploration and pump testing, a selected number of which can be used for monitoring purposes. Their proposed location is shown in figure V, and table 4 lists their approximate location, elevation and depths.

TABLE 4. PROPOSED EXPLORATORY BOREHOLES IN THE UMM-ER-RADHUMA AQUIFER

Borehole number	Coordinates		Elevation (metres above sea level)	Borehole depth (metres)	Depth to aquifer (metres)
	Latitude (North)	Longitude (East)			
1	29°36'	43°13'	475	150	ground level (gl)
2	29°50'	43°44'	375	225	gl
3	30°00'	44°00'	375	325	gl
4	29°17'	43°36'	525	175	gl
5	29°34'	44°00'	450	250	gl
6	29°36'	44°23'	425	375	100
7	29°00'	44°00'	525	225	gl
8	29°15'	44°19'	400	250	75
9	29°00'	44°31'	450	300	50
10	29°18'	44°52'	375	425	25
11	28°32'	44°24'	525	225	gl
12	29°00'	45°00'	375	425	gl

**Figure V. Proposed exploration of the Umm-er-Radhuma shared aquifer in Iraq and Saudi Arabia**



*The boundaries and names shown and the designations used on this map do not imply official endorsement or acceptance by the United Nations.*

## 2. The Upper Cretaceous (Aruma/Amman-Wadi Sir aquifer)

### (a) Development and management

In Saudi Arabia, the Aruma is a minor shale aquifer; not much is known about its equivalent in Iraq, the Tayarat. In Jordan, the Amman-Wadi Sir (equivalent to the Aruma) is a prolific aquifer, but little is known about its northward extension into the Syrian Arab Republic

At present, the aquifer is mainly exploited in Jordan, where yields and water quality, especially in the western highlands, are good. In general, abstraction exceeds recharge, and in many well field areas the groundwater is mined, as evidenced by declining water levels. In the Jordanian desert areas in the east and in northern Jordan (the panhandle), water quality is poor (2,000-5,000 mg/l), and any future exploitation will have to rely on storage reserves rather than recharge. Overall, the aquifer in Jordan is managed well, at least

within the reality of the water scarcity in arid countries. Further development in the northern panhandle and in the eastern desert is constrained by poor water quality, deep water levels in places, and the general lack of recharge. At this stage, there is insufficient information to formulate further groundwater development strategies. In the easternmost area of the panhandle of Jordan (Risha), the aquifer appears to be unsaturated. The unsaturated aquifer probably extends eastward into western Iraq, though it is impossible to be more definite, as existing information is unreliable. Development of the aquifer in this area, at least on a large scale, may not be possible. South of the panhandle and the Iraqi border, within Saudi Arabia, hydrogeological conditions are not well known, though it is believed that unsaturated or discontinuously saturated conditions may prevail. Again, the lack of saturation may preclude the development of the aquifer in this area. North of Jordan into the Syrian Arab Republic, little is known of the hydrogeology of the Amman-Wadi Sir aquifer, so development plans cannot be formulated.

(b) *Exploration and monitoring*

A regional hydrogeological study should be carried out in the areas of northern Sirhan, easternmost Jordan and Iraq in order to determine, as far as possible, the existing hydrogeological situation. Recommendations should be made for exploratory drilling should this be deemed necessary.

Limited exploration should be carried out in northern Jordan and the southern Syrian Arab Republic in order to determine the extension of the Amman-Wadi Sir aquifer into the latter country. The proposed investigation should define groundwater flow in the southern Syrian Arab Republic and identify that proportion of flow which moves southward into Jordan and the Yarmouk River. Four exploratory boreholes which may also be used as future monitoring points are proposed for the locations shown in figure VI. Table 5 lists the approximate locations, elevations and depths of the boreholes.

TABLE 5. PROPOSED EXPLORATORY BOREHOLES IN THE AMMAN-WADI SIR AQUIFER  
IN THE NORTH-SOUTH OF THE SYRIAN ARAB REPUBLIC

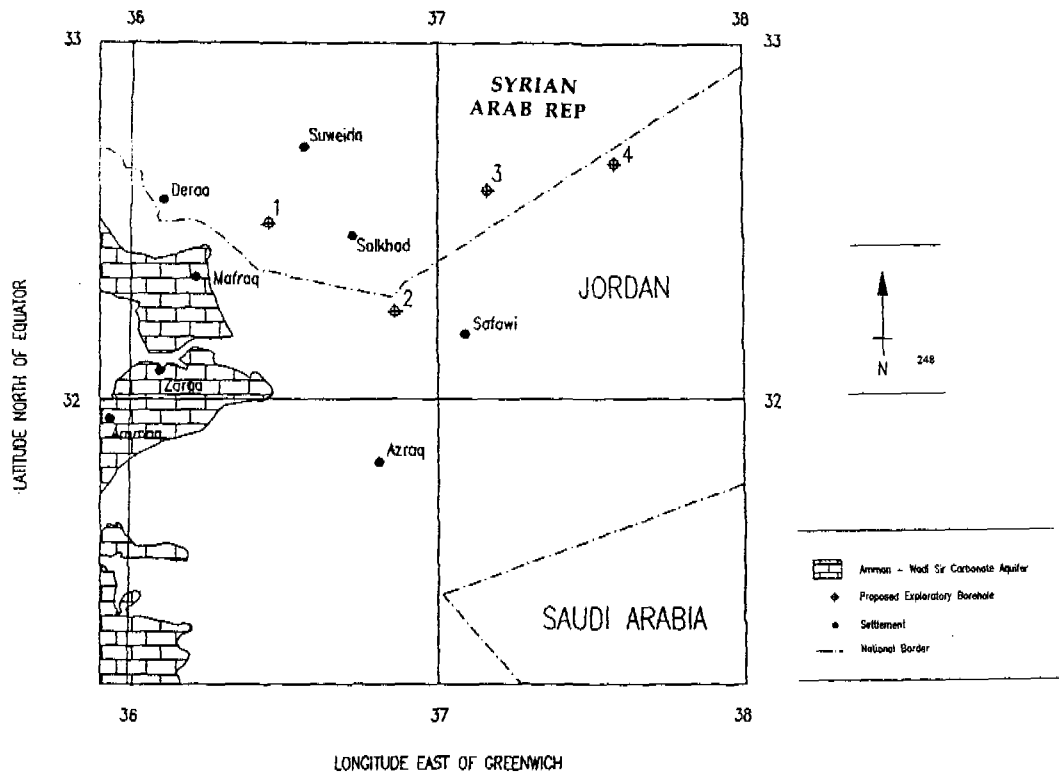
Borehole number	Coordinates		Elevation (metres above sea level)	Borehole depth (metres)	Depth to aquifer (metres)
	Latitude (North)	Longitude (East)			
1	32°28'	36°27'	800	800	600
2	32°15'	35°51'	975	1 025	825
3	32°35'	37°09'	750	1 000	800
4	32°40'	37°34'	750	850	650

D. COURSE OF ACTION

In the preceding sections, proposals have been put forward for the development, management, exploration and monitoring of shared aquifers. In order to facilitate their implementation, the following actions are recommended:

1. A committee should be set up consisting of experienced professionals from the ESCWA member countries with shared water resources. It may be useful for the committee to be chaired by someone from a non-sharing country or from an international organization such as ESCWA, the United Nations Development Programme (UNDP) or the Arab Centre for the Study of Arid Zones and Dry Lands (ACSAD).

**Figure VI. Proposed exploration of the Upper Cretaceous carbonate (Amman-Wadi Sir) shared aquifer in the Syrian Arab Republic and Jordan**



*The boundaries and names shown and the designations used on this map do not imply official endorsement or acceptance by the United Nations.*

2. The committee should do the following:

- (a) Define and agree upon the main issues relevant to the shared aquifers;
- (b) Determine common ground on which joint management, development, exploration and monitoring can proceed;
- (c) Select those shared aquifers which are of regional significance as sources of water supply and upon which attention should be focused as a matter of priority;
- (d) Establish a legislative framework for dealing with issues related to resources;
- (e) Set up technical sub-committees responsible for overseeing and implementing proposals.

3. A body should be established and charged with the collection, collation, processing and dissemination of information from the member countries concerned. It is recommended that a common computer database, preferably of the GIS type, be developed for this purpose which contains all relevant geological, hydrogeological and hydrochemical information concerning shared groundwater resources (including monitoring data) as it becomes available. The database should be accessible to all member countries, which should provide data on an annual basis, or on request.

# XXIII. GROUNDWATER QUALITY PROBLEMS IN THE ESCWA REGION AND THE POSSIBLE USE OF SATELLITE IMAGES FOR THE DEVELOPMENT OF GROUNDWATER PROTECTION STRATEGIES

*by*

*Wolfgang Wagner\**

## *Abstract*

The major quality constraint of groundwater use in the ESCWA member countries is its naturally high salinity in large parts of the region. Additionally, groundwater quality is threatened in many areas by human activities including the over-exploitation of aquifers, the unsafe disposal of liquid and solid waste, and irrigation return flow.

Preventing the intrusion of brackish or saline water into freshwater requires responsible groundwater management, which may include different measures to control hydraulic conditions. Strategies for groundwater protection against contamination from the surface may be developed through a groundwater vulnerability assessment and the translation of its results into groundwater protection measures. The vulnerability assessment can be affectively supported by the application of remote-sensing techniques, through which areas with specific hydrogeological conditions and areas with major contamination hazards can be delineated.

### A. REGIONAL FEATURES OF GROUNDWATER QUALITY IN THE ESCWA REGION

From a regional standpoint, the distribution of natural groundwater salinity in the ESCWA member countries is related to morphological, climatic and geological features: more humid climate conditions favour the formation of fresh groundwater resources; morphological features influence run-off and infiltration characteristics; and the geochemical reactivity of soil and rock material is a dominant factor in determining the concentration of dissolved substances in the groundwater.

The ESCWA region is made up primarily of zones with semi-arid to arid climates. Sub-humid climatic conditions extend over the western highlands and mountain ranges of Jordan, the Syrian Arab Republic and Lebanon and over mountain ranges at the south-eastern and south-western fringes of the Arabian Peninsula in south-western Saudi Arabia, Yemen and Oman.

Groundwater with low salinity extends over wide parts of the western mountain ranges, where the Mediterranean-type sub-humid climate and karstic aquifers create relatively favourable recharge conditions, and over the highlands and the western escarpment in Yemen.

In most of the semi-arid to arid areas covering the steppe (badia) in the northern Arab countries and most of the Arabian Peninsula, groundwater salinity is elevated to TDS levels ranging from less than 1,000 to several thousand milligrams per litre (mg/l). This general increase in groundwater salinity towards the more arid regions is largely related to climatic conditions: increased aridity is accompanied by decreased recharge and the increased impact of evaporative processes.

---

\* The author is the Hydrogeological Adviser to the United Nations Economic and Social Commission for Western Asia, Amman.

Some areas of the ESCWA region with very low rainfall contain groundwater resources adequate or marginal quality for domestic use or irrigation. These occurrences of fresh groundwater are related to the recharge of karstic or sandstone aquifers during more humid periods in the past or to recent recharge in extended wadi systems.

## B. MAIN GROUNDWATER QUALITY PROBLEMS

The major quality constraint against groundwater use in the ESCWA member countries is its naturally high salinity in extensive areas of the region. In the semi-arid to arid zones which cover most of Western Asia, the dilution of groundwater with fresh recharge is very limited, and groundwater salinity is elevated from lithogenic sources and from the enrichment of dissolved substances through evaporation.

In addition to natural salinity problems, groundwater quality is threatened in many areas by human activities such as those listed below:

(a) The over-exploitation of freshwater aquifers can result in the intrusion of brackish water contained in parts of the exploited aquifer or in adjacent aquifers. Increasing salinity may affect any type of groundwater use. The intrusion of brackish or saline water into exploited freshwater aquifers has to be expected in coastal aquifers, in wadi aquifers receiving limited modern recharge, and in aquifers with depleting fossil groundwater;

(b) The infiltration of domestic sewage from unsewered sanitation, leaking sewers or sewage oxidation lagoons can severely contaminate water-supply wells or springs, in particular through bacteria, viruses and elevated nitrogen compounds;

(c) Irrigation return flow can progressively increase the salinity of groundwater, affecting its further use for irrigation. Further, fertilizer and pesticide residues in irrigation return flow can endanger drinking water quality;

(d) The infiltration of untreated industrial wastewater can raise the concentrations of various substances above safe drinking water values (measured in terms of total salinity, major constituents, organic compounds and trace metals);

(e) Solid-waste disposal is an important source of subsurface contamination. If waste disposal sites are properly located, constructed and managed, the subsurface contaminant load is likely to be small in terms of both volume and hazard level, unless very hazardous wastes are involved.

## C. GROUNDWATER PROTECTION STRATEGIES

In addressing the significant problem of groundwater quality deterioration in the region, policies for groundwater quality conservation have to be directed towards two major hazards:

- (a) The intrusion of saline or brackish water into freshwater aquifers;
- (b) The contamination of groundwater from the surface.

### 1. *Preventing the intrusion of brackish or saline water*

Preventing the intrusion of water with higher salinity into freshwater aquifers requires the maintenance of a hydraulic equilibrium between the exploited freshwater and the brackish or saline water



which may intrude from adjacent aquifers or from surface-water bodies such as saline lakes, sabkhas and oceans.

The technical options for preventing the intrusion of naturally occurring saline or brackish water include the following:

- (a) Safe groundwater management, which in many cases, requires, a drastic reduction in groundwater abstraction in areas endangered by salt-water intrusion;
- (b) Optimization of the distribution and depth of extraction wells;
- (c) The simultaneous pumping of brackish or salt water in order to maintain the freshwater/salt water equilibrium;
- (d) The artificial infiltration of surface-water run-off (through wadi dams, for example);
- (e) The building of hydraulic barriers to prevent salt-water intrusion.

## *2. An assessment of groundwater vulnerability to contamination from the surface*

In developing a concept or strategy for protecting groundwater against contamination from the surface, the following should be considered:

- (a) The location of water-supply sources;
- (b) The extent and position of freshwater aquifers;
- (c) The vulnerability of freshwater aquifers;
- (d) Existing contamination hazards.

In addition, the existing and potential hazards related to groundwater quality deterioration must be known. These hazards are related to the following:

- (a) The physical and hydrochemical properties of the aquifer and the surrounding geological environment, including the soil zone;
- (b) Human activities which influence the natural hydrochemical equilibrium.

In this context, the concept of groundwater vulnerability has been introduced as a tool for groundwater protection programmes, where groundwater vulnerability represents the sensitivity of water quality to human activities.

Groundwater vulnerability assessment is widely applied in industrialized countries as a tool for setting up strategies and measures for protecting groundwater resources against future contamination. Usually, the results of groundwater vulnerability assessments are represented on maps which delineate specific areas and types of vulnerability.

An assessment of groundwater vulnerability to contamination from the surface should consider the following:

- (a) The occurrence of productive aquifers and categories of aquifer lithology according to the probable attenuation and transport of contaminants;
- (b) Depth to groundwater, permeability of covering layers, and hydraulic conditions;
- (c) Recharge conditions and areas with preferential indirect recharge;
- (d) Main sources of possible contamination including urban areas, larger settlements with unsewered sanitation, industrial areas, irrigation agriculture, wastewater irrigation and contaminated surface water;
- (e) The location of domestic water-supply sources.

Groundwater vulnerability assessment for more extensive areas may be supported by the application of remote-sensing techniques, including the interpretation of satellite (such as Landsat 5 or SPOT) images or of aerial photographs if higher resolution is required.

Valuable information can be obtained for groundwater vulnerability assessment from satellite images, particularly with regard to the following (Vrba & Zaporozec, 1994):

- (a) The distribution of high vertical drainage;
- (b) The location of permanently wet areas;
- (c) Existing land use;
- (d) Vegetative cover conditions;
- (e) Variations in soil texture;
- (f) Hydrogeological complexes.

In assessing the vulnerability of contamination from the surface in the ESCWA member countries, the following regional conditions are of particular relevance:

- (a) Fresh groundwater resources are restricted to areas with favourable climatic conditions and to very limited areas in the dry parts of the region;
- (b) A high percentage of the extracted groundwater is used for irrigation—some 70% - 80% in some countries; domestic use accounts for up to 25% of total water use in individual States;
- (c) *Depth-to-groundwater is considerable in large areas. Under prevailing climatic conditions, hazards of groundwater contamination are restricted to limited areas: (i) uncovered karstic aquifers in semi-humid zones with intensive land use; and (ii) areas where localized groundwater recharge is elevated by natural or man-made means, including wadis with significant run-off, irrigation areas, and areas where domestic or industrial sewage waters infiltrate into the subsurface;*
- (d) If contaminants have reached the groundwater, the freshwater recharge generally has a poor effect on diluting or flushing away the contaminants.

The region is dominated by semi-arid to arid climatic conditions, and even areas with relatively high rainfall such as the mountain ranges east of the Mediterranean Sea are characterized by a long, dry summer season. Under these conditions, groundwater recharge is generally low, the movement of contaminants in the unsaturated zone may be very restricted, and dilution may be minimal.

Soil cover, which may have a protective function for the groundwater, is poorly developed in many areas of the ESCWA region. The soil zone and the unsaturated zone, with their frequently considerable thickness and limited moisture content, have to be treated in the vulnerability assessment as a combined protective system.

In large steppe and desert areas, land use has no significant impact on the groundwater quality; hazardous activities are frequently concentrated in areas where valuable freshwater resources are found. Given such circumstances, the application of remote-sensing techniques appears useful as a fast and relatively inexpensive way to accomplish the following:

- (a) Define the geological structure and position of aquifers;
- (b) Delineate outcrops of vulnerable aquifers such as karstic, fissured and unconsolidated aquifers;
- (c) Delineate areas with protective soil cover;
- (d) Define different categories of recharge conditions according to surface drainage patterns, preferential localized infiltration of surface water, and soil cover;
- (e) Map areas with major groundwater contamination hazards, including urban and rural settlements, and industrial and irrigation areas.

### 3. MEASURES FOR PROTECTING GROUNDWATER AGAINST CONTAMINATION FROM THE SURFACE

Groundwater vulnerability assessment results have to be translated into groundwater protection measures.

In view of the sensitivity of drinking water supplies to water quality changes and the vital importance of safe drinking water, first priority for groundwater quality conservation must be given to the resources used for domestic supply, including:

- (a) Wells and springs used for water supply;
- (b) Groundwater occurrences of potable quality which are potential sources for future domestic supply.

In designing an efficient protection system for the production boreholes used for water supply, the concept of groundwater protection zones commonly applied in European countries may be adopted and modified according to local conditions.

The protecting of drinking water sources (boreholes or springs) generally falls into three categories (Matthess and others, 1985; Adams and Foster, 1991):

- (a) The protection of water-supply wells against direct contamination (immediate protection zone, operational courtyard);
- (b) The protection of water-supply wells against degradable contaminants, particularly bacteria and viruses (inner protection zone);

(c) The protection of the catchment area of water-supply wells against non-degradable and persistent contaminations (outer protection zone).

Different restrictions on land use apply in the immediate, inner and outer protection zones, according to the specific protection requirements of each.

Unused groundwater, which may provide resources for future water supply in the ESCWA member countries, is very limited, as most of the important aquifers in Western Asia are intensively exploited. Future domestic supplies may, however, rely on groundwater resources which are at present used mainly for irrigation. Conserving the quality of water for domestic supply in vulnerable aquifers within irrigation areas requires the control and management of both groundwater extraction and land use.

More specifically, steps must be taken to prevent increases in salinity and major ion concentrations, which affect the suitability of water for domestic supply and irrigation, and to prevent the introduction of fertilizer and pesticide residues which may affect water quality and render it unfit for domestic use. Optimizing irrigation practices can reduce the risk of groundwater contamination in irrigated areas. No reliable information is available on the impact of fertilizers and pesticides on groundwater quality under the specific conditions present in the ESCWA region. Groundwater contamination risks are especially high where untreated wastewater is used for irrigation above vulnerable aquifers.

## References

- Adams, B., and S.S.D. Foster. 1991. Land surface zoning for groundwater protection. A paper presented at the Annual Symposium on Groundwater Pollution and Aquifer Protection in Europe, held by the Institute of Water Environmental Protection in Paris in 1991.
- Matthess, G., S.S.D. Foster and A.C. Skinner. 1985. Theoretical background, hydrogeology and practice of groundwater protection zones. *International Contributions to Hydrogeology* (Hannover).
- Vrba, J., and A. Zaporozec. 1994, Guidebook on mapping groundwater vulnerability. *International Contributions to Hydrogeology*, No. 16 (Hannover).

## XXIV. RECHARGE AND QUANTITIES, CALCULATIONS OF SUSTAINABLE YIELDS OF GROUNDWATER

by

*Radwan Al-Wishah\**

The water situation in the ESCWA region is critical, and serious efforts must be made to develop and implement programmes for the sustainable management of groundwater resources. Water quantities and quality must be optimized to meet demand at minimum cost.

Groundwater occurs in aquifers, which can be viewed as subsurface reservoirs (as opposed to surface reservoirs such as dams and lakes) (see figure I). Because water is a valuable resource, particularly in this region, aquifers must be viewed as systems which should be operated at optimal levels.

The following represents the most advantageous aquifer-related situation:

- (a) A large-capacity storage site (usually associated with lower costs);
- (b) Low evaporation losses;
- (c) No conflict with existing land use;
- (d) No major structural (failure) risks;
- (e) Uniform water temperature;
- (f) Safe from immediate contamination.

### A. BACKGROUND AND DEFINITION OF TERMS

Implementing an effective and sustainable groundwater management programme requires a detailed analysis and understanding of each aquifer situation.

#### 1. *Basin inflow and outflow*

Most important is a determination of the available water in the groundwater basin. The continuity principle of the basin is reflected in the equation: inflow minus outflow equals change in storage. Total inflow includes surface and subsurface inflow, precipitation (net recharge) and imported water (from outside); total outflow includes surface and subsurface outflow, extraction (pumping) and exported water.

#### 2. *Basin yields*

Two-major approaches to yield exist: mining yield and perennial yield.

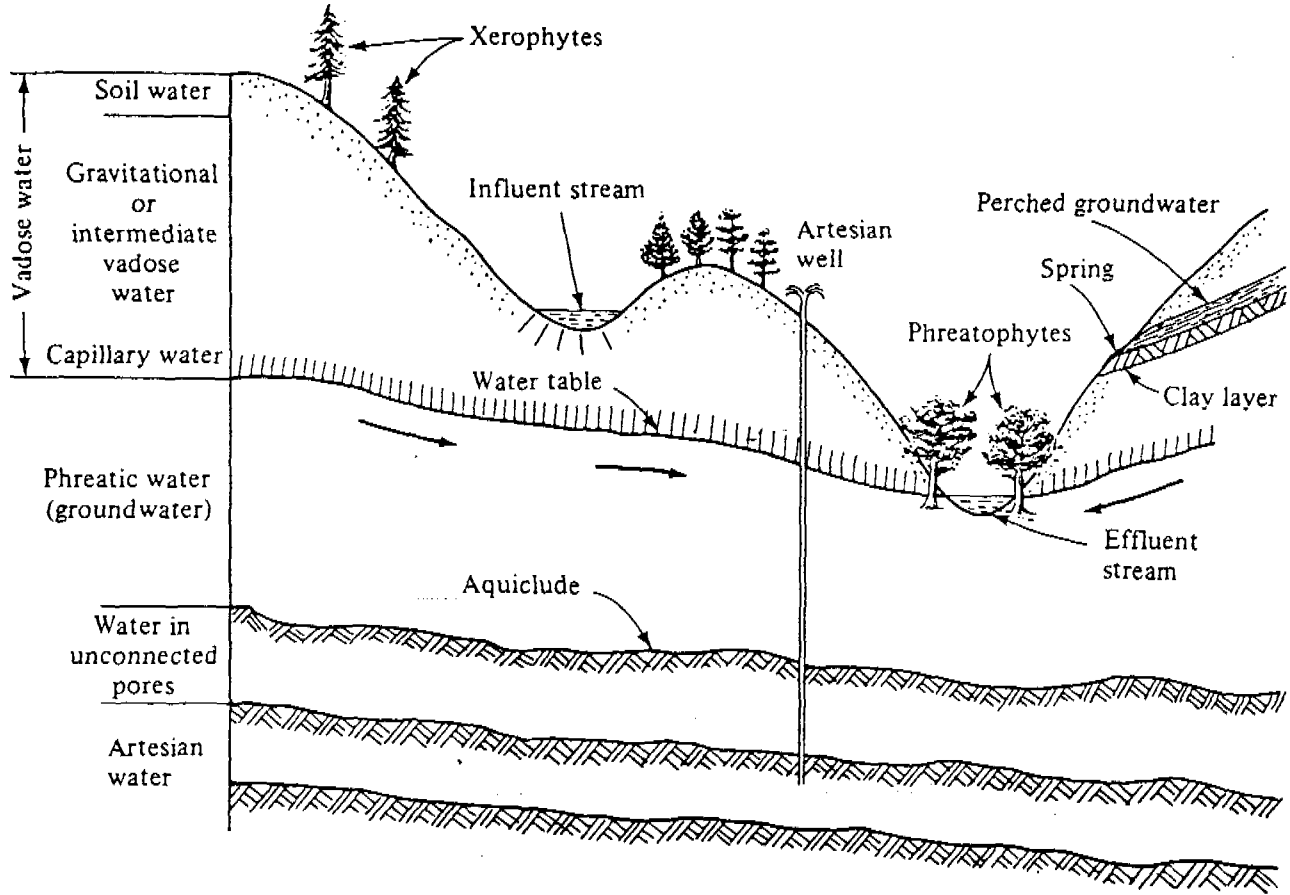
Mining yield refers to a situation where pumping exceeds recharge, resulting in the eventual depletion of the aquifer. Such abstraction may be carried out for economic, social and/or political reasons.

Perennial yield refers to the rate at which groundwater can be extracted perennially under specified operation conditions without any undesirable results. Perennial yield is also referred to as safe yield, which varies according to location within the basin and overtime; operating conditions should be specified in each case. Safe yield =  $P - R - E_{act} - G_o$ , where:  $P$  = average annual precipitation;  $E_{act}$  = actual evapotranspiration;

---

\* The author is a specialist at the Water and Environment Research and Study Department, University of Jordan, Amman.

**Figure I. General layout of a groundwater system**



$R$  = mean annual run-off; and  $G_o$  = net annual subsurface discharge from the aquifer (pumping, change in storage). With deferred perennial yield, two different pumping conditions may exist: the initial pumping rate is greater than the safe yield, resulting in a rapid decrease in the groundwater level; the second rate is comparable to the perennial yield. If actual draft exceeds the perennial yield, overdraft of exploitation of the aquifer occurs, resulting in the progressive reduction in water quantity, uneconomic pumping conditions, the degradation of groundwater quality, interference with prior water rights, land subsidence, and other environmental, social and political problems.

Maximum perennial yield reflects optimal management practices and recharge conditions. In basin recharge, the major criterion governing perennial yield may be limited by the availability and transmissibility of water and by contamination. Estimating recharge requires a comprehensive understanding of the basin hydrology (see box). The best management of the water basin is reflected in the conjunctive use of groundwater and surface water resources (natural and artificial recharge).

### BOX. THE SIMPLE ISLAND EXAMPLE

An approximately circular island of 100 square kilometres is underlain by a confined aquifer that is hydraulically connected to a big lake. This aquifer is utilized as a drinking water supply for a coastal town with needs of 0.15 MCM per year. The observed average annual decline in the piezometric surface is about 10 metres. The aquifer has a storage coefficient of 0.0001.

Average annual recharge to the aquifer from the lake can be determined as follows:

$$S = \frac{V_w}{A(-dh)}$$

(where storage coefficient  $S$  = volume of water ( $V_w$ ) released from aquifer per unit volume of aquifer;  $A$  = the area of the aquifer; and  $dh$  is the piezometric head decline).

or

$$V_w = S(A) (-dh) = 0.0001 * 100 * 106 * (10) = 0.1 \text{ MCM}$$
$$V_{\text{pumped}} = V_{\text{aquifer}} + V_{\text{lake}}$$

Thus,

$$V_{\text{lake}} = \text{recharge from the lake} = 0.15 - 0.1 = 0.05 \text{ MCM/year}$$

In order to avoid any recharge from the lake (owing to potential water quality problems), the yield of this aquifer should be restricted to 0.1 MCM.

### 3. Principles of groundwater recharge

Groundwater recharge may be natural and/or artificial. The purpose of artificial recharge is to enhance the infiltration of some of the surface water into the soil rather than allowing it to be lost through evaporation or run-off. Artificial recharge methods vary according to basin topography, geology and hydrology (see figure II).

There are a number of different mechanisms for the artificial recharge of a groundwater aquifer; the following are the most often used:

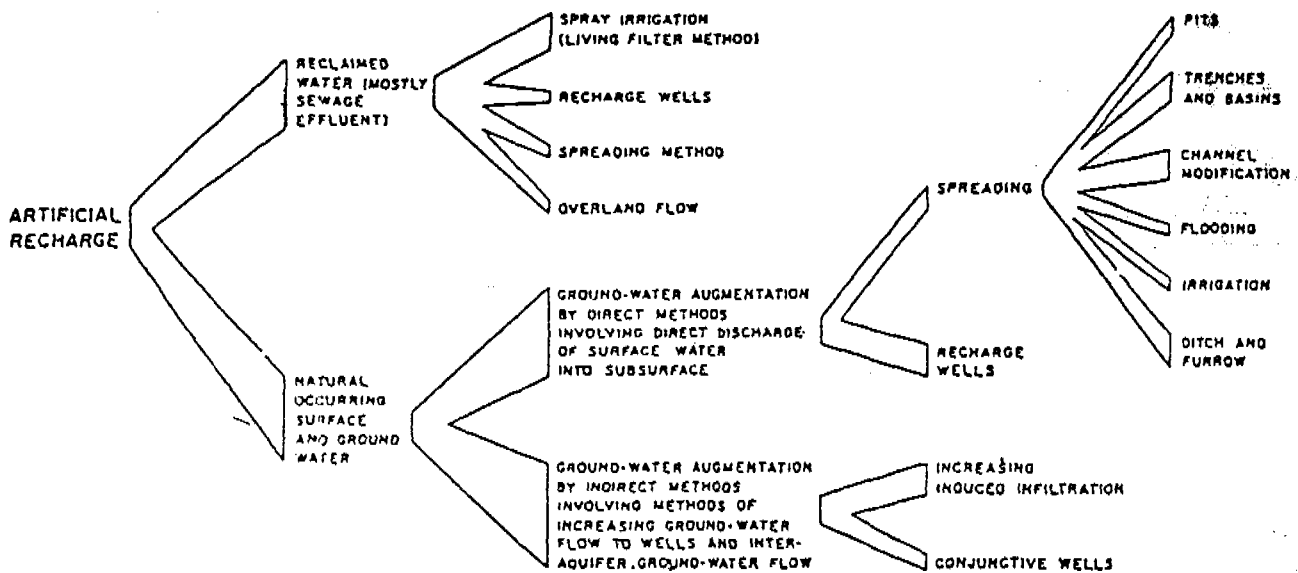
(a) Injection wells are usually suitable for shallow depths (less than 20 metres deep) and allow for the reversed flow of water into the well (see figures III and IV);

(b) Horizontal drains are elongated drains which are filled with gravel and sand to increase filtration and reduce silt accumulations. The smaller hydraulic gradient makes this type of drain much less efficient than a well in terms of infiltration;

(c) Drainage slots are elongated slots filled with gravel. They operate like very long basins and have a high lateral infiltration rate (see figure V). The water to be infiltrated is supplied in a concrete-lined ditch with a pervious bottom. The uppermost layers act as a filter, retaining silt and fine deposits;



**Figure II. Artificial recharge methods**



Source: W. S. Motts and others, "Feasibility of increasing water supplies and preventing environmental damage by artificial recharge in Massachusetts", Publication No. 132, Water Resources Research Center, University of Massachusetts (Amherst).

(d) Infiltration basins are basins separated by dykes. To ensure a high level of efficiency and easy operation, the infiltration area should be divided into different basins, with overflow connections provided between them; when the first basin is filled, the water flows into the next one, and so on (see figure VI);

(e) Recharge ditches are elongated, excavated ditches which are connected to one another by a number of channels to ensure the continuity of the recharge (infiltration). The width of the ditches is determined by topography and permissible velocity to prevent erosion;

(f) Recharge dams are small, preferably permeable dams which collect water and allow it to infiltrate into the groundwater. The last dam downstream must be fitted out with an additional outlet to divert the floods which exceed the capacity of the infiltration structures into the wadi (see figure VII).

## B. THE HYDRAULICS OF GROUNDWATER RECHARGE

### 1. Recharge under saturated conditions in an unconfined aquifer

Under saturated flow conditions, the force of gravity plays a dominant role. When rainfall constitutes the input, water movement is governed by Darcy's law:

$$(1) \quad Q = 2\pi h K d h / d r$$

From continuity, the net recharge volume is as follows:

$$(2) \quad dQ = -2\pi r N$$

(where  $N$  represents the net infiltration rate;  $h$  is the hydraulic head;  $K$  represents conductivity, and  $r$  is the radius of the well.)

Integrating equation 2 above yields the following:

$$(3) \quad Q = -\pi r^2 N + C_1$$

in which  $C_1$  is an integration constant which can be determined from boundary conditions. For example, when  $r = r_0 \equiv 0$ , then  $Q = Q_0$  (for example) the steady pumping rate from the well) or:

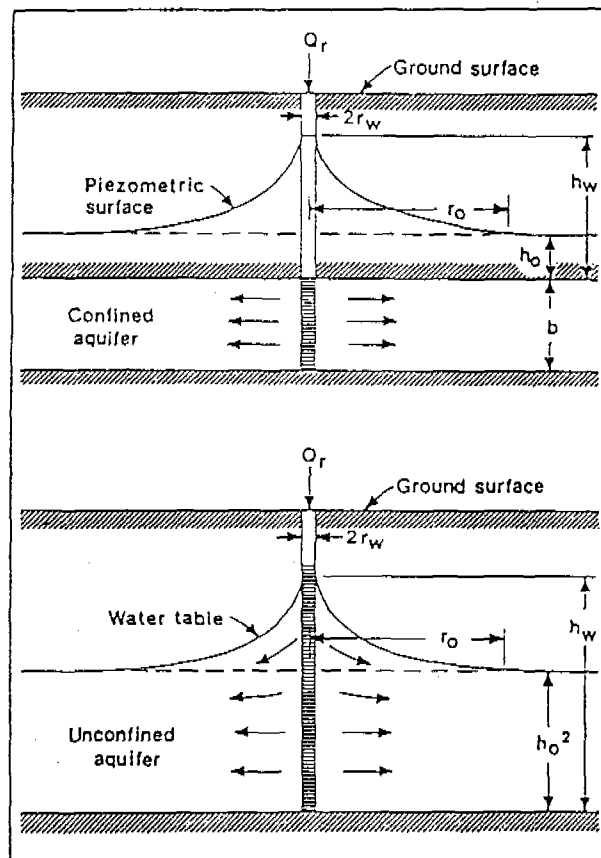
$$(4) \quad Q = -\pi r^2 N + Q_0$$

Substituting equation 4 for the Darcy's law (equation 1) and rearranging yields produces the following result:

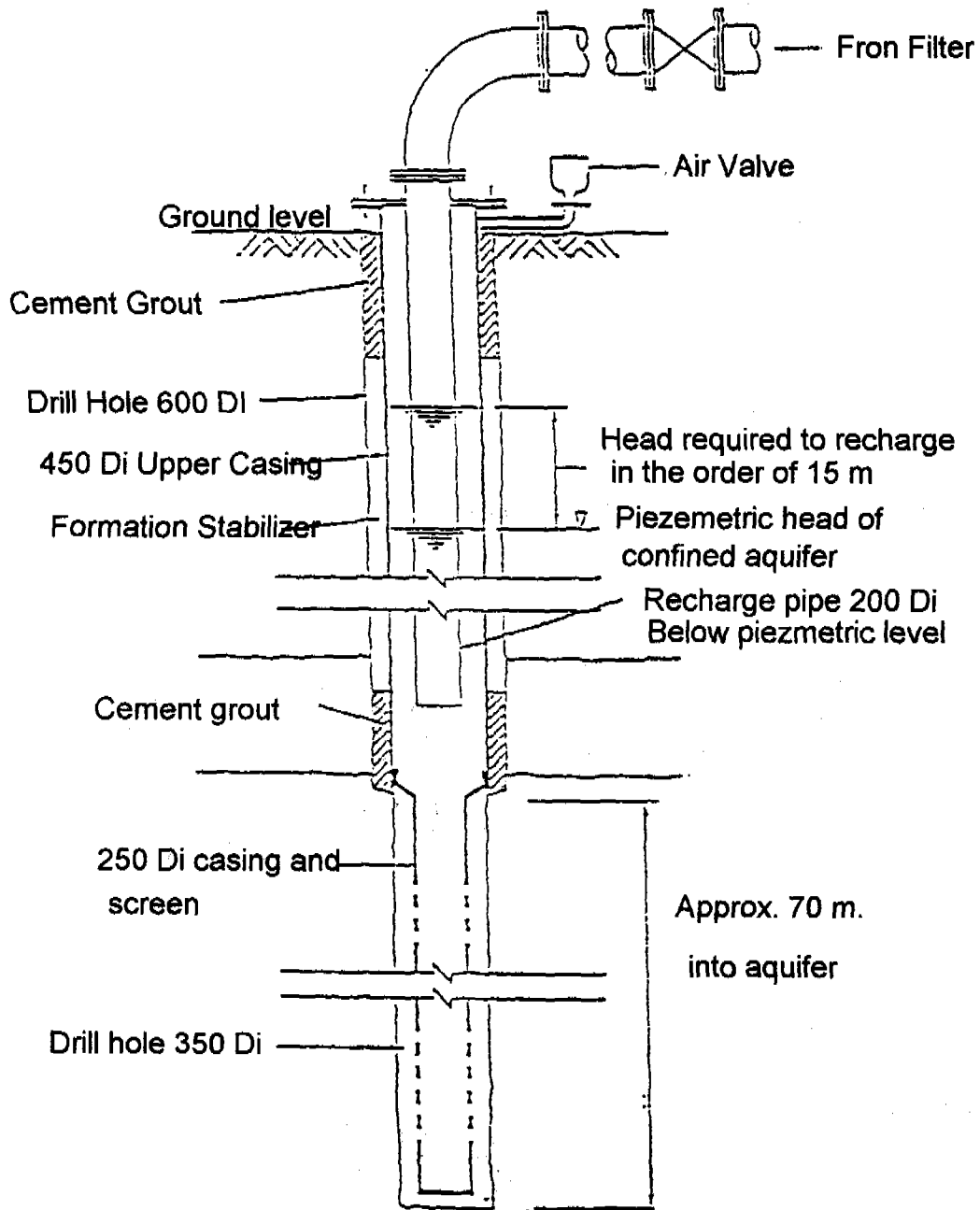
$$(5) \quad h^2 = Q_0/\pi K \ln r - (N/2k)r^2 + C_2$$

where  $C_2$  is another constant of integration which must be estimated based on boundary conditions. It should be noted that equation 5 is basically a superposition of pure recharge case and the pumping well without recharge conditions.

**Figure III. Radial flow from recharge wells penetrating (a) confined and (b) unconfined aquifers**

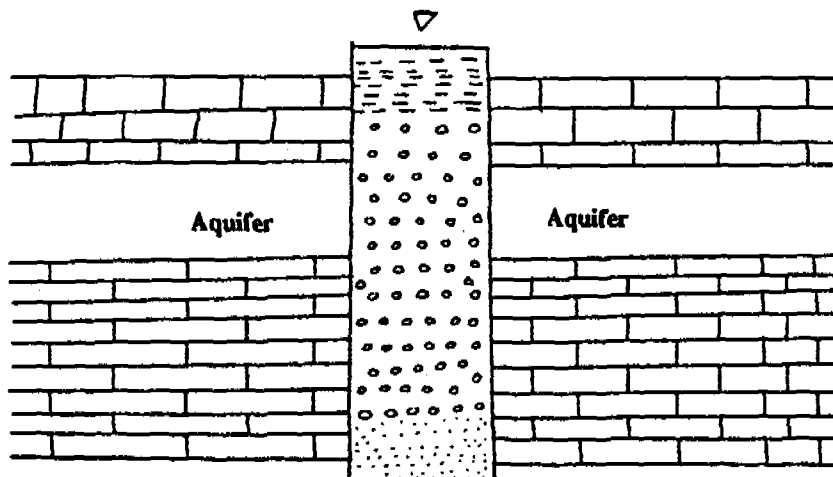


**Figure IV. Details of a recharge injection well**



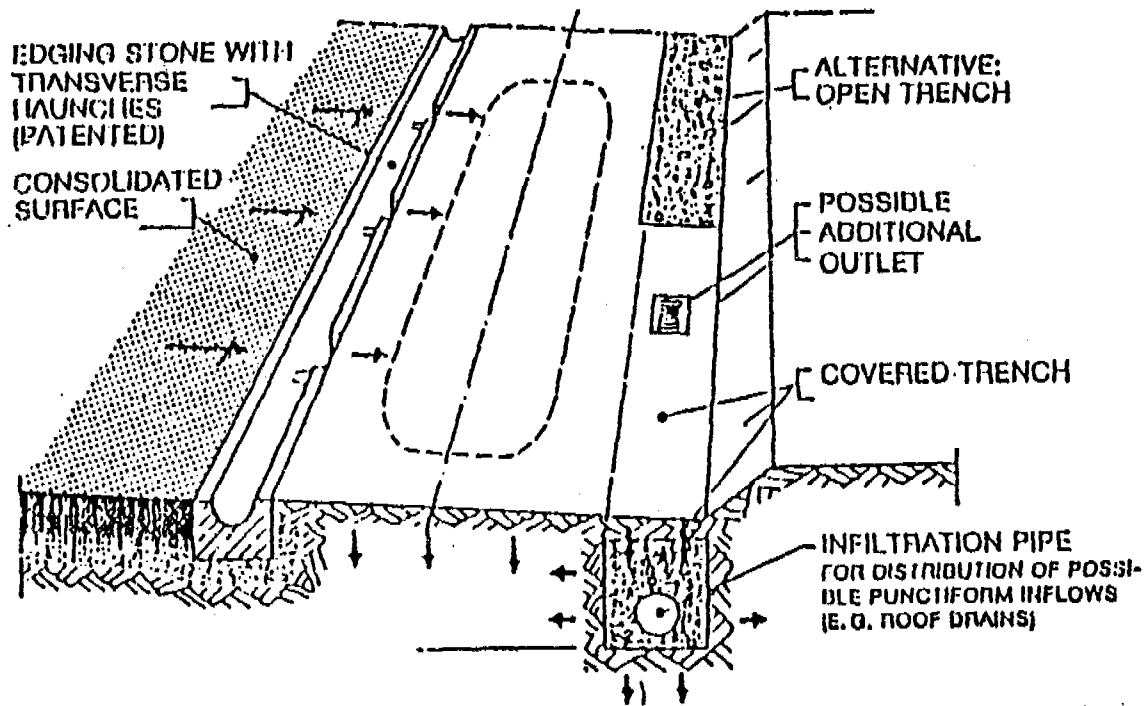
Source: The University of Jordan, "The potential of artificial recharge of groundwater", Proceedings of the Regional Seminar, Water and Environmental Research and Study Centre (Amman, 1993).

**Figure V. Drainage slots (Wildenhanhn, 1985)**



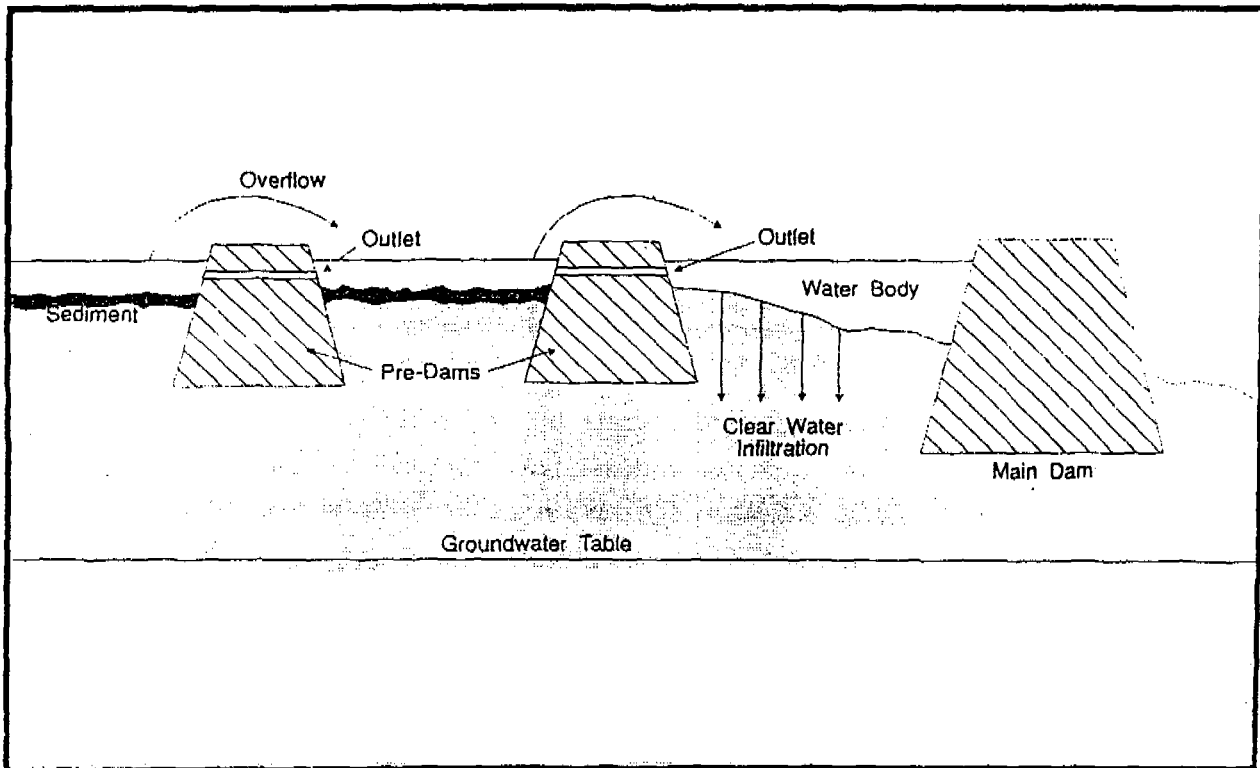
Source: A. Wildenhanhn, "Utilization of short floods for artificial groundwater recharge measures", Workshop on Surface Water Hydrology in the Arab World (Damascus, 1985).

**Figure VI. Infiltration basin**



Source: The University of Jordan, "The potential of artificial recharge of groundwater", Proceedings of the Regional Seminar, Water and Environmental Research and Study Centre (Amman, 1993).

**Figure VII. Recharge dams**



Source: The University of Jordan, "The potential of artificial recharge of groundwater", Proceedings of the Regional Seminar, Water and Environmental Research and Study Centre (Amman, 1993).

## 2. Recharge in an unsaturated zone

Unlike flow under saturated conditions, unsaturated flow is dominated by capillary rather than gravitational forces. The governing equation for unsteady unsaturated flow in porous media is the Richard's equation, in the following form:

$$(6) \quad \frac{\partial \theta}{\partial t} = \frac{\partial}{\partial z} (D \frac{\partial \theta}{\partial z} + K)$$

where  $D$  is the soil water diffusivity, which has a dimension of ( $L^2/T$ );  $K$  is the hydraulic conductivity,  $\theta$  is the moisture content of the soil; and  $z$  is the depth parameter.

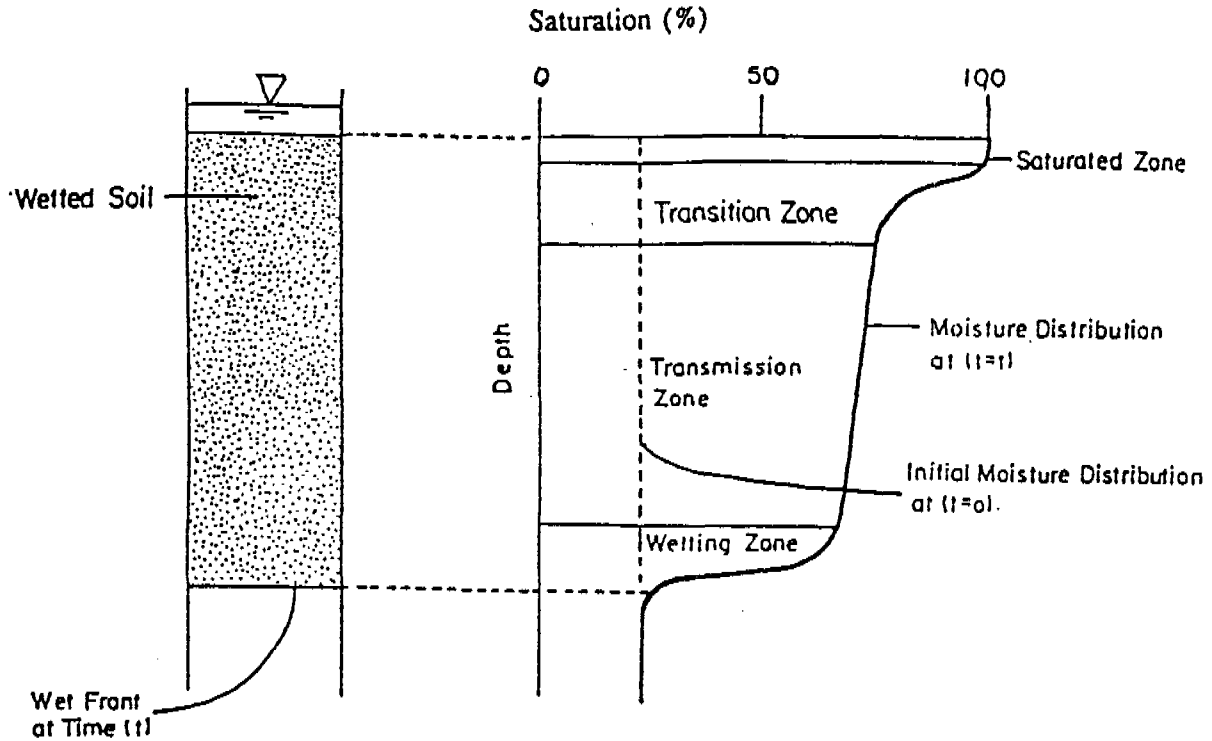
Phillip presented a solution to Richard's equation by assuming that both  $K$  and  $D$  vary with the moisture content. Using some mathematical transformations, both equations were reduced to ordinary differential equations. According to Phillip, the cumulative infiltration can be approximated by:

$$(7) \quad F(t) = St^{0.5} + Kt$$

where S is the soil sortivity, which is a function of the soil suction potential; and t is the time. The two terms in Phillip's equation represent the effects of soil suction head and gravity head respectively.

An alternative approach, based on a physical theory that has an exact solution, was the Green Ampt equation, which involves introducing a wetting front infiltration model (see figure VIII). This method forms the theoretical basis for the computer model using the wetting front concept.

**Figure VIII. The wetting front in unsaturated subsurface flow**



Source: J. Bear, D. Zaslavsky and S. Irmay, "Physical principles of water percolation and seepage" (Paris, UNESCO, 1968).

## References

- Bear, J., D. Zaslavsky and S. Inmay. 1968. Physical principals of water percolation and seepage. Paris, UNESCO.
- Motts, W. S. and others. 1983. Feasibility of increasing water supplies and preventing environmental damage by artificial recharge in Massachusetts. Publication No. 132. Water Resources Research Center, University of Massachusetts, Amherst.
- University of Jordan. 1993. The potential of artificial recharge of groundwater. Proceedings of the Regional Seminar. Water and Environmental Research and Study Centre. Amman.
- Wildenhanhn, A. 1985. Utilization of short floods for artificial groundwater recharge measures. Workshop on Surface Water Hydrology in the Arab World, Damascus, 1985.

# XXV. LANDSAT THEMATIC MAPPER IMAGERY OF THE CENOZOIC VOLCANIC FIELD OF JORDAN AND THE SYRIAN ARAB REPUBLIC

by

Uwe Schaffer\*

Landsat Thematic Mapper (TM) satellite imagery has been produced using different TM-band combinations and ground truth for the basalt area of northern Jordan and the southern Syrian Arab Republic. With the aid of satellite imagery, a synoptic geological model of the Neogene and Quaternary basalts has been developed on the scale 1:250,000. The basalt area is composed of Neogene plateau basalt and Quaternary and Recent basaltic lava flows and shield volcanoes. The TM data has provided new detailed, information on the distribution and differentiation of the basalt series.

All of the basalts of the area derive from magmatic sources originating from the earth's upper mantle. They belong to the family of continental within-plate basalts. The basalt area under study is situated in a tectonic frame which is related to the pivot of the NNE-SSW trending Araba-Jordan Rift Valley and the NW-SE trending Wadi Sirhan depression. The emplacement of the first plateau basalts is considered to be Miocene/Pliocene. Basaltic dyke feeders extend along NW-SE trending fault systems. The Neogene plateau basalts reach a thickness of about 1,500 metres in the Jebel el Arab area. Quaternary basaltic lava flows and shield volcanoes are emplaced as point source feeders along NNW-SSE trending lineaments which crosscut the Neogene series. Their total thickness varies from a few metres to 150 metres.

From the satellite imagery of the basalt, hydrological features relevant to the exploration of water resources (including drainage patterns) can be distinguished. The poorly developed drainage patterns of the Miocene-Pliocene plateau basalt and of the Pleistocene shield basalt series indicate the infiltration of surface run-off from the highly developed drainage systems of valley-filling lava flow terrains and possibly also from *in-situ* rainfall. The Miocene-Pliocene plateau basalts reach thicknesses of several hundred metres and are intercalated by soil and sedimentary interlayers. Deep vertical fractures (cooling cracks caused by contraction) are prominent in these plateau basalts and may create favourable groundwater movement conditions. Unconsolidated Quaternary tuff and scoria volcanoes and tuff and scoria terrains may have relatively high infiltration capacities.

Quaternary valley-filling lava flows and weathered tuff terrains show differentiated drainage patterns which give evidence of rapid water transportation into morphological depressions delineated as mud pans. The weathered tuff terrains are covered by fine-grained sediments (clay material) which reduce infiltration and recharge into underlying rocks or soil layers. Salinity increases in the sediment pans owing to evaporation.

Basaltic dykes crosscutting the entire area may have created hydraulic barriers. They may separate areas with different groundwater levels and differentiate the basalt aquifers into compartments with different aquiferous properties.

A detailed description of the Neogene and Quaternary basalt series is provided below; the abbreviations (Qp, Qvs and so on) are used to designate the respective areas on the geological maps (not shown here):

---

\* The author is a remote-sensing expert associated with the United Nations Economic and Social Commission for Western Asia in Amman.



- (a) *Mud pans (Qp)*. Fine-grained sediments (clay minerals) fill morphological depressions;
- (b) *Volcaniclastics and sediments (Qvs)*. Undifferentiated volcanic sediments are located in the central part of the eastern Neogene and Quaternary volcanic field. They fill a tectonic window and overlay Neogene basalt Nb1;
- (c) *Holocene shield basalt (flow 1: Qb5), (flow 2: Qb6), (flow 3: Qb7)*. The last basalt eruptions, considered to be Holocene, are restricted to the NE of the basalt field. An alteration crust is totally lacking. The eruption of this series is related to the northern continuation and revival of volcanic activity in Recent times;
- (d) *Upper Quaternary basaltic lava flows and shield basalt (Qb4, Qb4a, Qb4b)*. Lava flows and shield basalt of the Upper Quaternary (possibly Holocene) are present north and south of the Jebel el Arab. They are linked to point source feeders which are characterized by scoriaceous cones (Qfe). They are considered to be the youngest series distributed in the region;
- (e) *Middle Quaternary basaltic lava flows and shield basalt (Qb3)*. The Al-Laja basalt sheet has a maximum thickness of about 15 metres and belongs to the well-preserved basaltic lava flows of the region. The typical weathered colour in the satellite image and the thick cover of weathered surface observed in the field suggests that the Qb3 is Middle Quaternary. Inside weathered boulders, the highly vesicular basalt is absolutely fresh as, evidenced by green olivine phenocrysts;
- (f) *Lower Quaternary (Pleistocene) basaltic lava flows (Qb2)*. Lower Quaternary lava flows occur as valley-filling lava deposits. Most of them show point source feeders which were developed in a late stage of eruption as cinder and scoria cones (Qfe). The Qb2 is thought to extend over large areas in the W, SW and SE of the Jebel el Arab, although in most parts of the area a thick soil cover is present. Unlike the plateau basalt and shield basalt, the valley-filling lava flows deposited in a pre-existing morphological relief. Ongoing mechanical erosion caused by the transportation of debris through the valleys provides the Qb2 with its dark, unweathered colour in the satellite image;
- (g) *Lower Quaternary (Pleistocene) shield basalt (Qb1)*. Lower Quaternary basalt occurs as flood basalt with a preserved surface of pahoehoe lava (predominantly considered to be shield basalt). In places, the basalt shows point source feeders which are delineated as cinder and scoria cones (Qfe). Along NNW-ESE and NW-SE trending lineaments, old pahoehoe lavas occur as shield volcanoes, the feeder zones of which appear indistinct and in outline only. The basalt corresponds to the hyalobasalt  $\beta_1 Q_1$  described by the geologists working in the Syrian Arab Republic (Krasnov and others, 1966);
- (h) *Lower Quaternary until Holocene basaltic tuff (Qt)*. Tuff material is connected to cinder and scoriaceous material;
- (i) *Lower Quaternary until Holocene cinder and scoria (Qfe)*. Cinder and scoriaceous cones are restricted to Quaternary (Pleistocene and Holocene) point source feeders. They are emplaced at the final stage of the magmatic activity and are characterized by a high content of iron oxides. They occur predominantly in two parallel chains of volcanic cones extending NNW-SSE;
- (j) *Quaternary (undivided) basaltic lava flows (Qb)*. Basaltic flows of uncertain stratigraphic position extend over the eastern slope of the Jebel el Arab. In outcrops in the area of Safawi (formerly H5), this basalt shows slightly altered olivine phenocrysts. This fact might indicate an early Quaternary or late Tertiary age. The unit is defined on the map as undivided Quaternary Basaltic Lava Flows;

(k) *Neogene basaltic dykes (Ndk)*. Basaltic dyke systems cross-cut the Neogene plateau basalts; they occur only in the Neogene basalt areas. In the present study they are considered older than Pleistocene. In earlier studies, the basaltic dykes were defined as Upper Pleistocene. (B'd unit of Bender, 1974; and B6 of van den Boom and Suwwan, 1966). In the field the dykes show the alteration of olivine phenocrysts typical of (and restricted to) Neogene basalts. The basalts are of the fine-grained dense and coarse-grained porous varieties. In some areas the dykes occur as erosional remnants and can be outlined as morphological windows piercing through the Lower Quaternary basalt of Qb1 and Qb2;

(l) *Neogene (Pliocene) plateau basalt (Nb3)*. In the south-east of the mapped area a basalt unit overlying the Nb2 basalt can be distinguished by satellite imagery. Based on its geometric situation and the colour of its weathered basalt, Nb3 is considered to be Neogene;

(m) *Neogene (Pliocene) plateau basalt (Nb2)*. The Neogene plateau basalt Nb2 crops out in the central part of the Jebel el Arab, where it probably reaches its greatest thickness. In the area east of the Jebel el Arab the Nb2 basalt covers wide areas;

(n) *Neogene (Miocene) plateau basalt (Nb1)*. The oldest basalt occurring in the mapped area is defined as Neogene basalt Nb1. It occurs in the southern region of the basalt field in the vicinity of Safawi and in the north-east of the mapped area. Obviously, the plateau basalt occurs over a large area and is very thick under the Jebel el Arab. It corresponds to the  $\beta N_1$  ( $\beta N_1^2$ ) of Krasnov and others (1966), the Safawi Group of Ibrahim (1993), probably the B4-basalt of van den Boom and Suwwan (1966), and partly to the BII-basalt of Kruck and Wagner (1982).

## References

- Bender, F. 1974. Geology of Jordan. Contributions to the Regional Geology of the Earth, Gebr. Borntraeger-Berlin-Stuttgart.
- Van den Boom, G., and Suwwan. 1966. Report on geological and petrological studies of the plateaubasalts in NE Jordan. Unpublished report, German Geological Mission in Jordan, Bundesanstalt für Bodenforschung, Archive Nr. 23715. Hannover, May 1966.
- Ibrahim, K. 1993. The geological framework for the Harrat Ash-Sham basaltic super-group and its volcanotectonic evolution. Jordan, Ministry of Energy and Mineral Resources, Natural Resources Authority. *Bulletin No. 25* (Amman).
- Krasnov, A.A., V.G. Kazmin, and V.V. Kulakov. 1966. Explanatory notes on the geological map of Syria 1:200,000. Syrian Arab Republic, Ministry of Industry, Department of Geological and Mineral Research. USSR, TECHNOEXPORT.
- Kruck W., and W. Wagner. 1982. Report on activities and results in the field of geology and hydrogeology, 1978-1982: part II-1, Geology of the Hamad region. Unpublished report of the Federal Institute for Geosciences and Natural Resources (BGR), Hannover, in cooperation with the Arab Centre for the Study of Arid Zones and Dry Lands (ACSAD). Damascus.

# XXVI. ASPECTS OF THE GEOLOGICAL EVOLUTION OF THE SOUTH-WESTERN PART OF THE ARABIAN PLATE: THE RESULTS OF GEOLOGICAL MAPPING IN THE REPUBLIC OF YEMEN

by

*Uwe Schaffer\**

The geological mapping of the former Yemen Arab Republic<sup>1</sup> carried out by the Federal Institute for Geosciences and Natural Resources (BGR, Germany) in conjunction with the Ministry of Oil and Mineral Resources of the former Yemen Arab Republic has provided new data which is contributing to a better understanding of the evolution of the Arabian Shield (see figure).

## A. PRECAMBRIAN BASEMENT

According to other sources, the Precambrian series within the Arabian Peninsula must be regarded essentially as the result of polyphase evolution. Different types of interactive movement across plate boundaries affected the Arabian Shield, including its extension, compression and strike-slip. Three main phases of the evolution of the Arabian Shield are thought to have occurred and are described in some detail below.

The first phase is considered to be a pre-Pan-African-rift event which occurred between 1,200 and 950 million years before the present era (Ma BP). It is postulated that in the extreme south-east of the former Yemen Arab Republic extensive occurrences of spilitic ocean floor basalt existed in the past and now represent the current remnant ocean floor terrain; the latter is interpreted to be a relatively unreformed primitive ocean crust from before the Pan-African rift event.

The second phase was dominated by compression, strike-slip faulting, enzymatic island arc development and the initiation of collision-related intracratonic magmatism and tectonism. This occurred between 950 and 550 Ma BP during the Pan-African orogeny and is understood to be the Pan-African microplate accretion of the Arabian Shield.

Accretional processes produced distinct terrains which still exist and are easy to define in the field and on satellite imagery. The different types are: (a) craton terrains, which are rafted continental remnants of older crust; (b) ocean floor terrains, which are delineated by the content of primitive ocean crust fragments; and (c) arc terrains, which are composed of magmatites and arc and back-arc basin complexes. The magmatites of the Suq al Inan terrain in the north and the As Sawadiyah terrain in the south are assumed to be of pre-Pan-African origin.

Intensively deformed pre- or syntectonic early Pan-African acidic intrusions indicate early subduction-related magmatites.

The arc terrains are well developed and consist of steeply striking meta-volcano-sedimentary sequences and subalkaline acidic and basic (ultramafic) intrusive. They have been highly deformed by wrench faulting. Subduction phenomena and associated arc/back-arc magmatism are related to the subsequent

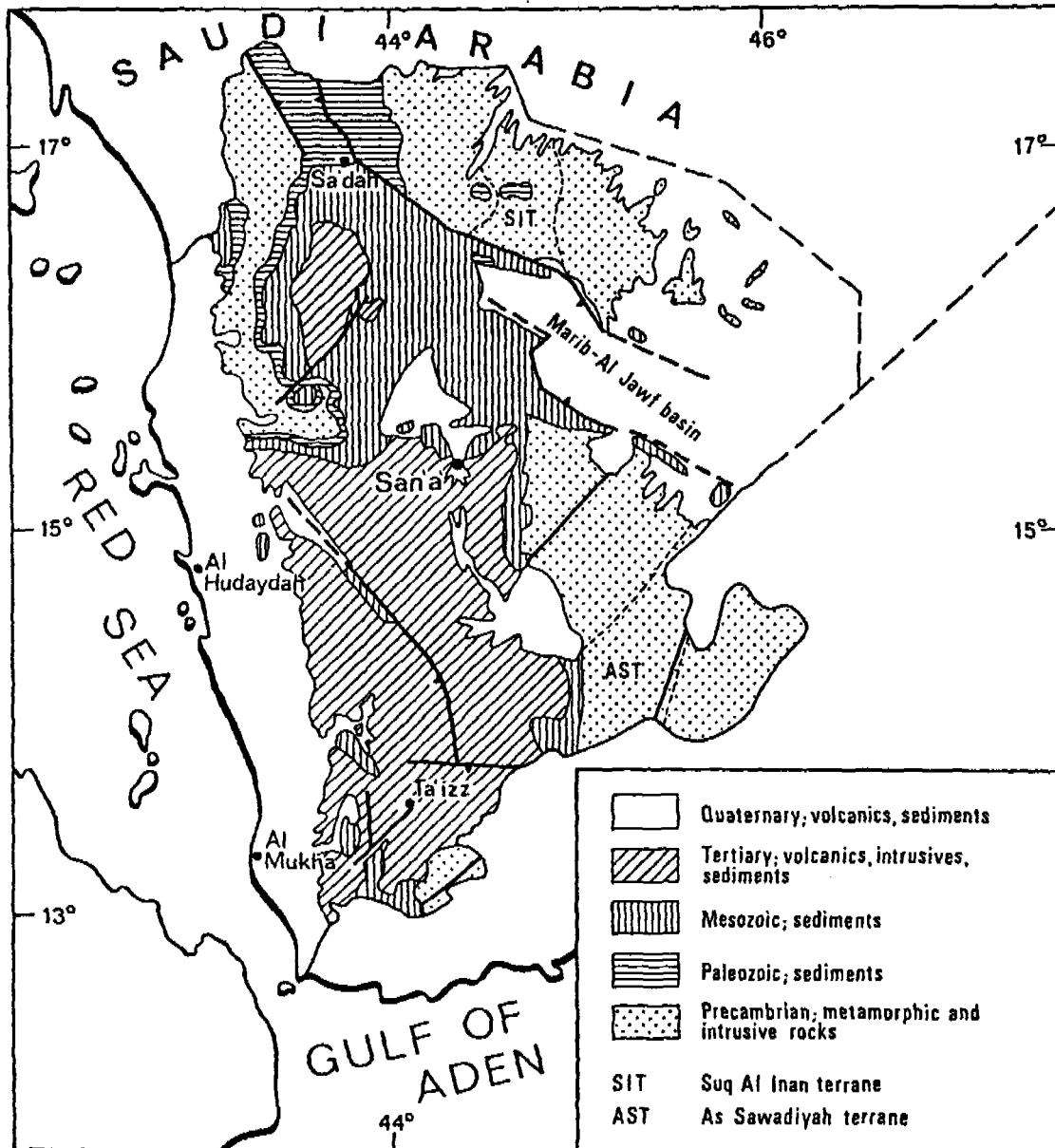
---

\* The author is a remote-sensing expert associated with the United Nations Economic and Social Commission for Western Asia in Amman.

<sup>1</sup> On 22 May 1990 the People's Democratic Republic of Yemen and the Yemen Arab Republic merged to form a single State, and have since been known as the Republic of Yemen.

compression. Thermal flux caused by the consolidation of basic intrusive has probably led to massive intra-crustal fusion. Extensive areas of the arc terrains are intruded upon by host-rock-assimilating palingenetic granite. Generally, palingenetic granite occurs within the arc terrains or at the boundary between arc and craton terrains. In the vicinity of volcanosedimentary troughs and their related acidic magmatites, extremely shortened fold belts or, alternatively, steeply dipping subduction zones are revealed.

Figure. Geological sketch map of the former Yemen Arab Republic



*The boundaries and names shown and the designations used on this map do not imply official endorsement or acceptance by the United Nations.*

The third phase, during the later part of the Pan-African orogeny, was dominated by the cratonization of the accreted arc and craton Arabian terrains. This resulted in the initiation of peraluminous and peralkaline within-plate granitic intrusions. Both types are genetically combined as bimodal partial-fusion products from a within-plate source. Post-orogenic within-plate granite intrusions indicate an intermediate or relatively thick undepleted continental crust formed at the end of the Precambrian.

## B. PHANEROZOIC COVER

No significant tectonic events occurred during the Palaeozoic. However, the distribution and the direction of transport of the Wajid sandstone in the northern part of the former Yemen Arab Republic and in Saudi Arabia indicates an epirogenetic uplift in the extreme south of the Arabian Peninsula. The Wajid sandstone wedges out at lat.  $15^{\circ} 45' N$ , and lower Permian glacial deposits overlie the Precambrian basement further south.

The tectonic situation during the Triassic is not clear. During the Jurassic, the southern Arabian Peninsula began to separate into basin and range provinces. The Marib-Al Jauf basin was initiated during the Kimmeridgian and was filled by some 5,000 metres of sediments until the transition to the Cretaceous. The basin's origin is related to the disengagement of the southern Arabian Peninsula from the main block through clockwise rotation. The pivot was situated in the Sadah area to the north-west. The uplift and erosion of the northern Arabian Shield probably began during the Upper Jurassic, as indicated by the transport directions of Upper Jurassic sandstone; this movement continued during the Cretaceous.

During the Palaeocene, the direction of transport changed to south-east, explaining the presence of an uplift in the area of the present Red Sea between the former Yemen Arab Republic and northern Ethiopia. The initiation of the Red Sea valley took place during the Miocene and was characterized by normal antithetic faulting. Miocene Baid clastics and evaporites are deposited in a protorift depression. Since the Miocene, the Precambrian basement of the eastern rift shoulder has been uplifted locally to approximately 3,000 metres asl.

In the north-western part of the former Yemen Arab Republic, the Red Sea direction of faults is evident at the rift shoulder.

The south-western edge of the Arabian Peninsula is intersected by a complex fault pattern which includes NNW-SSE Red Sea and E-W Aden elements. NE trending faults are Precambrian-initiated and Tertiary-reanimated.

The volcanological evolution during the Tertiary involved upper mantle heat and material transfer and continuous crustal attenuation which began in the Late Proterozoic and ended during the late Tertiary.

During the middle Eocene the volcanic eruptive phase started, with alternations of trap basalts and trap rhyolites. Crustal attenuation reached its maximum with associated tholeiitic ridge volcanism (sea-floor spreading) in the Red Sea graben during the Palaeocene.

Tertiary NS-striking dyke swarms, consisting of microcrystalline porphyritic rhyolites extending from Al Mukha to the Al Hudaydah area, are feeder components of Yemeni rhyolitic trap volcanics. It is assumed that this rock type is associated with the occurrence of the Red Sea rift event. The rhyolitic dyke is unique; it indicates the influence of the continental ridge and feeder zone that introduced peralkaline acidic volcanics of a deep continental magma source with upper mantle participation. The Tertiary magmatites of the former Yemen Arab Republic tend to have high-alkaline differentiation (alkaline basalt and alkaline rhyolite). Alkaline basalts are partial-fusion products from an upper mantle source. Peralkaline rhyolites are produced

by partial fusion of the lower crust and magma mixing. Trace-element geochemistry reveals a single magmatic differentiation, together with crustal paligenetic potassium, Na-rich melts and the late-stage contamination of alkalis by volatile transfer. A geotectonic androgenic position is indicated comparable to ascending island flood basalts, flood rhyolites and late alkaline granitic intrusive.

The magmatic event during the Tertiary occurred in a continental shelf setting characterized by the deposit of in a submarine or saliferous lacustrine environment and of trap volcanics on the land surface. Peralkaline acidic and basaltic flows and ashes represent the Quaternary volcanism related to the Aden volcanics.

## Bibliography

- Geukens, F. Geology of the Arabian Peninsula, a review of the geology of Yemen (translated from French by S.D. Bowers). Professional Papers of the United States Geological Survey, 560-B. Washington, 1966. 23 pp.
- Grolier, M.J., and W.C. Overstreet. Geologic map of the Yemen Arab Republic (Sana'a) (1:500,000); Reston: United States Geological Survey, 1 sheet. Miscellaneous Investigation Series, Map I-1143-B. 1978.
- Kruck, W., and U. Schäffer. Geological map of the Republic of Yemen (scale 1:250,000, 8 sheets). Hannover, Germany, Federal Institute of Geosciences and Natural Resources, 1991.
- Kruck, W., U. Schäffer and J. Thiele. Explanatory notes on the Geological Map of the Republic of Yemen-Western Part (Former Yemen Arab Republic). *Geol. Jb.* (1995).
- Kruck, W., and J. Thiele. Late Paleozoic glacial deposits in the Yemen Arab Republic. *Geol. Jb.*, B46 (1983). Pp. 3-29.
- Michel, J.C., and others. Mineral master plan. *BRGM Report 88 Yem 154*. 1989. 546 pp.
- Stoeser, D.B., and V.E. Camp. Pan-African microplate accretion of the Arabian Shield. *Geological Society of America Bulletin*, vol. 96 (1985). Pp. 817-826.
- Vail, J.R. Pan-African (late Precambrian) tectonic terrains and the reconstruction of the Arabian-Nubian Shield. *Geology*, vol. 13 (1985). Pp. 839-842.



## **ANNEXES**



Annex I

**LIST OF PARTICIPANTS\***

**A. ESCWA MEMBERS**

*Egypt*

Mr. Ayman El-Said Abourgila  
Hydrologist, Planning Sector  
Ministry of Public Works and Water Resources  
Cairo  
Tel.: 3123272  
Fax.: 3129263

Mr. Ibrahim Hamouda El-Sebaie  
Engineer/Hydrologist  
Nile Forecasting Center, Planning Sector  
Ministry of Public Works and Water Resources  
Cairo  
Tel.: 3123272  
Fax.: 3129263

*Jordan*

Mr. Yousef Jubran Qassar  
Geological Engineer  
Water Resources Studies Directorate  
Jordan Water Authority, Amman  
Tel.: 680100/683100

Mr. Mahmoud Musallam Thweib  
Geologist  
Water Resources Studies Directorate  
Jordan Water Authority, Amman  
Tel.: 680100/683100

*Oman*

Mr. Hussain Jama Ismail Bait-Ishaq  
GIS Analyst  
GIS Section/Department of Technical Services  
Ministry of Water Resources  
P.O.Box 2575 Ruwi  
Postal Code No. 112, Muscat  
Tel.: (968) 593112  
Fax.: (968) 593121

Ms. Nasra Bint Khaled Bin Rashid Al-Harthy  
Geologist  
Remote Sensing Section/Department of Technical  
Services  
Ministry of Water Resources  
P.O.Box 2575 Ruwi  
Postal Code No. 112, Muscat  
Tel.: (968) 593112  
Fax.: (968) 593121

*Palestine*

Mr. Ghassan Talal Naji Mohammad Abu Ju'ub  
Water Directorate  
Ministry of Planning and International Cooperation  
Dahier El-Barid, Ramallah  
Tel.: 972-2-5747044  
Fax.: 972-2-5747044

Ms. Fadia Daibes  
Hydrogeologist  
Palestinian Water Authority  
East Jerusalem  
P.O.Box 51875  
Tel.: 972-2-5749031  
Fax.: 972-2-276072

Mr. Ali Yaseen  
Hydrogeologist  
Arab Studies Society  
Ministry of Planning  
Jerusalem  
Fax.: 972-2-287805

*Qatar*

Mr. Ali Mohamed Saad Al-Kaabi  
Geologist  
Agriculture and Water Research Department  
Ministry of Municipal Affairs and Agriculture  
Doha  
Tel.: 433400  
Fax.: 413395/414868

---

\* Issued as submitted.

Mr. Qassem Mohamed Qurban Al-Bukhari  
Geologist  
Agriculture and Water Research Department  
Ministry of Municipal Affairs and Agriculture  
Doha  
Tel.: 433400  
Fax.: 413395/414868

*Saudi Arabia*

Mr. Abdulmalik Ibrahim Al-Sulaiman  
Geologist  
Water Resources Development Department  
Ministry of Agriculture and Water  
Riyadh  
Tel.: 966-1-4022479  
Fax.: 966-1-4022479

*Syrian Arab Republic*

Mr. Marwan Koudmani  
Expert in Remote Sensing  
General Director's Office  
General Organization of Remote Sensing  
P.O.Box 12586, Damascus  
Tel.: 2218700  
Fax.: 3910700

Mr. Munzer Jahjah  
Electrical Engineer/Head of Equipment  
Department  
Data Processing and Production  
General Organization of Remote Sensing  
P.O.Box 12586, Damascus  
Tel.: 2218700  
Fax.: 3910700

*Yemen*

Mr. Ahmed Amer Hassan Al-Hamayri  
General Manager of Field Survey  
Sana'a Survey Authority  
Presidency of the Council of Ministers  
Sana'a  
Tel.: 252690/252586  
Fax.: 252589

Mr. Abdo Saeed Saif Fara'a  
Director of Cadastral Survey Department  
Sana'a Survey Authority  
Presidency of the Council of Ministers  
Sana'a  
Tel.: 252690/252586  
Fax.: 252589

Mr. Abdulla M. Althary  
Hydrogeologist/Director General  
Geophysical Department  
Mineral Exploration Board  
Ministry of Oil and Mineral Resources  
P.O.Box 1052  
Sana'a  
Fax.: 251264

**B. ROYAL JORDANIAN GEOGRAPHIC CENTRE (RJGC) SECRETARIAT**

Mr. Salim Khalifa  
Director General  
P.O.Box 414, Al-Jubaiheh 11941  
Amman  
Tel.: (962 6) 845188  
Fax.: (962 6) 847694

Mr. Mubarak Mubarak  
Vice-Director of RJGC

Mr. Rafe Ashour  
Director of Production Department

Mr. Omar Malkawi  
Researcher

Mr. Ahmad Al-Mefleh  
Director of Modern Applications Department

Mr. Ibrahim Abdulla Obaid  
Director of Technical Service Department

Mr. Mashhour Habaybeh  
Head of Finance Section

Mr. Mahmoud H. Malkawi  
Director of Public Relations

C. LECTURERS

Mr. Andreas Charalambous  
Director  
Hydrogeological Services International Ltd.  
172 B Epsom Road  
Guildford  
Surrey GUJ 2RR  
London  
Tel.: 0483-504221  
Fax.: 0483-35759

Mr. Ali Saad  
Hydrologist/Researcher  
Jordan Water Authority  
P.O.Box 2412  
Amman  
Tel.: 680100

Mr. Ezz Eddin Madhar  
Remote Sensing Researcher  
Royal Jordanian Geographic Centre  
Amman

Mr. Ghazi Qussous  
GIS Researcher  
Royal Jordanian Geographic Centre  
Amman

Mr. Hamid Al-Naimy  
Professor at Al-Bait University  
Amman

Mr. Hussein Harahsheh  
Remote Sensing Researcher  
Royal Jordanian Geographic Centre  
Amman

Mr. Mohammed Al-Sallaq  
Consultant in Hydrology  
Ministry of Water and Irrigation  
Amman

Mr. Mohammed Shatnawi  
Head of Water and Environment Research and  
Study Centre  
University of Jordan  
Amman  
Tel.: (962 6) 843555

Mr. Mufid Hamza  
Remote Sensing Researcher  
Royal Jordanian Geographic Centre

Mr. Muneer Qudaisat  
GIS Researcher  
Royal Jordanian Geographic Centre

Mr. Munther Kharraz  
Ministry of Agriculture  
Amman  
Tel.: (962 6) 686151

Mr. Omar Malkkawi  
Researcher designated for the ESCWA Project  
on behalf of the Royal Jordanian Geographic  
Centre

Mr. Omar Qudah  
Remote Sensing Researcher  
Royal Jordanian Geographic Centre  
Amman

Mr. Radwan Al-Weshah  
Water and Environment Research and Study  
Centre  
University of Jordan  
Amman  
Tel.: (962 6) 843555, ext. 2332

Mr. Rafe Ashour  
Director of Production Department  
Royal Jordanian Geographic Centre  
Amman

Mr. Salem Al-Hussein  
Planning Researcher  
Royal Jordanian Geographic Centre  
Amman

Mr. Wolfgang Wagner  
Hydrogeological Advisor  
ESCWA  
Amman

Mr. Uwe Schaffer  
Remote Sensing Expert  
ESCWA  
Amman

D. ESCWA SECRETARIAT

(P.O. Box 927115, Amman; tel.: 962-6-606847; fax: 962-6-696476)

Mr. Mundhir Abdul-Salam (ext. 206)  
Chief  
Energy, Natural Resources and Environment  
Division (ENRED)

Mr. Mohamed Abdul-Razzak (ext. 210)  
First Economic Affairs Officer  
Natural Resources Section/ENRED

Mr. Omar Touqan (ext. 133)  
Senior Economic Affairs Officer  
Natural Resources Section/ENRED

Ms. Farida Al-Jadir (ext. 138)  
Senior Research Assistant  
Natural Resources Section/ENRED

## Annex II

### **PROGRAMME OF WORK**

#### Saturday, 2 December 1995

- 9.30 - 10 a.m. Registration
- 10 -10.30 a.m. Scope and objectives of the training course (ESCWA)
- 10.30 - 11 a.m. Break
- 11 a.m. - 12.45 p.m. Introduction to the Royal Jordanian Geographical Centre (RJGC) activities and tour of the facilities
- 1 - 2 p.m. "Basic principles of remote sensing" (Omar Malkawi)

#### Sunday, 3 December 1995

- 8.30 - 9.30 a.m. Overview of the Geographic Information Systems (GIS) (Muneer Qudaisat)
- 9.30 - 10.30 a.m. Opening ceremony (RJGC-UNEP-ESCWA)
- 10.30 - 11 a.m. Break
- 11 a.m. - Noon Concepts of data integration (remote-sensing, GIS and related field data) (Qudah)
- Noon - 3 p.m. "Digital image processing" (Samih Rawashdeh)
- Demonstration on workstations<sup>1</sup> (RS and GIS) (Mufid Hamza, Hussein Harahsheh and Ghazi Qussous)

#### Monday, 4 December 1995

- 8.30 - 9.30 a.m. "Remote-sensing: platforms and sensors" (Hamid Al-Naimy)
- 9.30 - 10.30 a.m. Analysis of RS data through GIS software (Rafe Ashour)
- 10.30 - 11 a.m. Break
- 11 a.m. - Noon Introduction to the Arc/Info System (digital mapping) (Ghazi Qussous)
- Noon - 3 p.m. Demonstration on image interpretation techniques\* (Mufid Hamza and Hussein Harahsheh)

Tuesday, 5 December 1995

- 8.30 - 9.30 a.m. "Project planning and design using new techniques (RS and GIS) (Salem Al-Hussein)
- 9.30 - 10.30 a.m. ESCWA project on the assessment of water resources using RS techniques (Omar Malkawi)
- 10.30 - 11 a.m. Break
- 11 a.m. - Noon "Surface-water bodies and catchment characteristics" (Mohammed Shatanawi)
- Noon - 3 p.m. Demonstration on the RS and GIS delineation of major catchments and SWBs in the ESCWA region\* (Mufid Hamza, Hussein Harahsheh and Ezz Eddin Madhar)

Wednesday, 6 December 1995

- 8.30 - 9.30 a.m. Monitoring of rainfall and ET (?) variability in time and space (Ali Saad)
- 9.30 - 10.30 a.m. "Shared surface water in the ESCWA region" (Mohamed Al-Sallag)
- 10.30 - 11 a.m. Break
- 11 a.m. - Noon Soil moisture processes (Munther Karraz)
- Noon - 3 p.m. Demonstration on soil moisture and soil erosion\*; demonstration on land slides (?) and desertification\* (Mufid Hamza and Ezz Eddin Madhar)

Thursday, 7 December 1995

- 8.30 - 9.30 a.m. "Development of vegetation and land-use maps in the ESCWA region" (Hussein Harahsheh)
- 9.30 - 10.30 a.m. Soil erosion processes (Munther Karraz)
- 10.30 - 11 a.m. Break
- 11 a.m. - Noon "Major geological lineaments" (Mufid Hamza)

---

\* Application on systems.



Saturday, 9 December 1995

- 8.30 - 9.30 a.m. "Recharge and quantities, calculations of sustainable yields of groundwater" (Radwan Al-Wishah)
- 9.30 - 10.30 a.m. "Hydrogeological overview of aquifer systems in the ESCWA region" (Andreas Charalambous)
- 10.30 - 11 a.m. Break
- 11 a.m. - Noon "Groundwater quality problems in the ESCWA region and the possible use of satellite images for the development of groundwater protection strategies" (Wolfgang Wanger)
- Noon - 3 p.m. Demonstration on vegetation and land-use map\* (Hussein Harahsheh); identification of major lineaments of shared aquifers\* (Mufid Hamza)

Sunday, 10 December 1995

- 8.30 - 10.30 a.m. "Major shared groundwater bassins in the ESCWA region: hydrogeology and hydrochemistry" (Andreas Charalambous)
- 10.30 - 11 a.m. Break
- 11 a.m. - Noon Landsat Thematic Mapper imagery of the Cenozoic volcanic field of Jordan and the Syrian Arab Republic (Uwe Schaffer)
- Noon - 3 p.m. Delineation of recharge areas\* (Ezz Eddin Madhar); Flood in Petra\* (Omar Qudah)

Monday, 11 December 1995

- 8.30 - 9.30 a.m. "Aspects of the geological evolution of the south-western part of the Arabian plate: the results of geological mapping in the Republic of Yemen" (Uwe Schaffer)
- 9.30 - 10.30 a.m. "Principles of groundwater evaluation of crystalline aquifers" (Andreas Charalambous)
- 10.30 - 11 a.m. Break
- 11 a.m. - Noon "Potential feasibility of development and management strategies of the major groundwater basins of the ESCWA region" (Andreas Charalambous)
- Noon - 3 p.m. Visit to King Talal Dam

---

\* Application on systems.

Tuesday, 12 December 1995

8.30 - 9.30 a.m.	Panel discussion
9.30 - 10.30 a.m.	Training course evaluation
10.30 - 11 a.m.	Break
11 a.m. - Noon	Closing session

Annex III

**QUESTIONNAIRE**

**Training Course on "Using Remote-Sensing Data and  
GIS Techniques in Hydrology and Hydrogeology  
ESCWA/UNEP/RJGC  
(Amman, Jordan 2-12 1995)**

Name: \_\_\_\_\_

Place of employment: \_\_\_\_\_

Address: \_\_\_\_\_

Position: \_\_\_\_\_

In this position since: \_\_\_\_\_

If you were in a different position before the training course, please fill out the section below:

Place of employment  
before the course \_\_\_\_\_

Address: \_\_\_\_\_

Position: \_\_\_\_\_

In this position since: \_\_\_\_\_

*About the Training Course:*

1. From the professional point of view, what did you like most about the training course?

\_\_\_\_\_  
\_\_\_\_\_  
\_\_\_\_\_

2. What did you think was inappropriate or ineffective?

\_\_\_\_\_  
\_\_\_\_\_  
\_\_\_\_\_

3. How can it be improved? Please give suggestions.

---

---

---

4. Are you participating in panels concerned with water resources planning and/or contributing to the formulation of a national action plan for your home country? If so, do you feel that the knowledge you have gained during the training course will be beneficial with respect to such efforts?

---

---

---

5. Do you think that remotely sensed imagery (combined with Geographic Information Systems and hydrological data) is an appropriate tool for water resources assessment in the ESCWA region?

---

---

---

6. Is such a database being used for planning purposes in your home country? Please give examples.

---

---

---

7. Did the course relate to the work of your colleagues?

Yes  No

If yes, have you shared the information you have obtained with them?

Yes  No

If yes (if you shared), how? Please explain.

---

---

---

Please return this questionnaire to ESCWA as soon as possible.