



WEDC *Water, Engineering
and Development Centre*

UNIVERSITY OF LEICESTERSHIRE
RESEARCH CENTRE
FOR COMMUNITY WATER SUPPLY AND
SANITATION (WEDC)

**RESEARCH INTO COST EFFECTIVE
TECHNOLOGIES FOR WATER SUPPLY
IN GUINEA WORM ENDEMIC AREAS**

Brian Skinner and Richard Franceys

DRAFT FINAL REPORT

Funded by:
UNICEF
3 United Nations Plaza
New York, New York 10017
USA

WEDC
Loughborough University of Technology
Leicestershire LE11 3TU England

Phone: 0 (44) 509 222617
Fax: 0 (44) 509 211079 201-92RE-11066

**RESEARCH INTO COST EFFECTIVE
TECHNOLOGIES FOR WATER SUPPLY
IN GUINEA WORM ENDEMIC AREAS**

Brian Skinner and Richard Franceys

November 1992

**Water Engineering and Development Centre,
Loughborough University of Technology
Leicestershire, UK**

DRAFT FINAL REPORT

**for
UNICEF
3 United Nations Plaza
New York**

LIBRARY, INTERNATIONAL RESEARCH CENTRE FOR COST EFFECTIVE WATER SUPPLY AND WASTE MANAGEMENT P.O. BOX 50100, 2500 AD THE HAGUE Tel. (070) 814911 ext. 141/142 IN: Dn 11066 LO: 201 Q2RE
--

EXECUTIVE SUMMARY

The purpose of this study is to investigate alternative low cost technologies for providing improved drinking water systems that can be used in isolated communities and areas with difficult hydrogeological conditions in order to reduce per capita costs to below US\$30 per capita. These technologies have to be easily replicated on a large scale and have to be provided as quickly as possible to achieve the eradication of Guinea worm within this decade.

Based on a literature survey and direct reports from projects the study clarifies the choices available for small community rural water supply. Costs collected during the course of the study vary widely even for the same technology, partly because they have been based on widely different assumptions regarding, for example, overheads and amortization but also because field conditions vary widely. Very little cost data is available for some of the technologies. The production of 'typical unit costs' for the technologies studied has therefore not been attempted.

However, the results of the study indicate that *appropriate CHOICE* between the various options for cost effective technology is more significant than the particular cost effectiveness of any individual technology. It is not the role of this study to investigate programme implementation. However, to achieve cost effective technology the implementation process must be designed to enable consumers to choose the technology which they find to be most suitable.

- None of the technologies investigated will be effective without adequate consumer involvement.
- For sponsors who desire sustainable benefits as rapidly as possible the only solution is to dramatically increase their spending on information, education and communication (marketing and selling) in order to encourage the necessary changes in traditional water drawing practices and the fast take-up of the consumer's choice of improvement.

The transmission of Guinea worm disease can be prevented by interventions which do nothing to improve the usual poor bacteriological quality of the water. Such faecally contaminated water is contributing to many other diseases, and even deaths in the community.

The report includes sections that give suggestions for interventions which reduce the transmission of Guinea worm disease without much, or any improvement in the bacteriological quality of the water. The authors are of the opinion that while in the very short term methods which only strain out, or kill, the water fleas (copepods) which carry the disease may be needed the provision of a potable water sources should be an urgent priority. It should be noted that although the straining and use of insecticide may lead to the eventual elimination of Guinea worm disease these interventions will have to be followed at some stage by the provision of a potable water supply if the level of health in the community is to rise appreciably. If a potable water source can be quickly supplied then the costs of many of the straining and insecticide interventions can be saved.

In the report the water supply technologies have been considered in three categories. These are considered in the order of preference for conveniently supplying sufficient quantities of a good quality of potable water, namely:

- Groundwater
- Rainwater
- Surface water

Groundwater exploitation has already played an important part in the eradication of Guinea worm disease from a number of places in the world. Groundwater has two main advantages:

- it is usually potable and free of any copepods to be infected with Guinea worm larvae. It does not usually contain faecal pathogens or other contaminants;
- aquifers are often extensive and in such cases it is usually possible to locate a well very near to a community needing water.

The main disadvantages of exploiting groundwater are:

- it can be difficult to excavate the hole necessary to reach the ground water. This problem increases as the depth to the groundwater increases and with the hardness of the sub-strata.
- except in the case of springs and artesian wells, some way has to be found to lift the groundwater up to ground level. This problem obviously increases with the height of lift required, and extraction using a handpump is increasingly difficult as the groundwater depth increases. Few handpumps are acceptable to communities where the lift is beyond about 45 metres below the surface and because of the increased forces on the components of such pumps they need to be very robust.

The most important observations and recommendations to arise from the section are:

- Where springs occur full use should be made of them. When they are properly protected they can supply potable groundwater, in most cases without the need for a pumping device. Cost effective spring protection designs which do not need spring boxes are available.
- Appropriate groundwater location techniques should always be used to avoid as much as possible the cost of wasted boreholes or wells;
- Hand-drilled boreholes have great potential where the strata is suitable. They are often more cost effective than hand dug wells but unlike draw wells they need sustainable handpumps for the withdrawal of water. The boring equipment is relatively cheap and usually very portable, and the community can be fully involved in its use for borehole construction.
- In a limited category of strata the use of wash-bored tubewells is very cost effective and it can lead to the very rapid construction of tubewells.
- In many cases low yielding strata, traditionally not considered suitable for groundwater exploitation, can be used to

supply water to a community. This is especially true when hand dug wells are constructed but very low yielding aquifers can be exploited by a tubewell if it is designed to serve only a small population, such as would be the case when using the Blair bucket pump.

- Where the groundwater is not excessively deep, open hand dug wells have great potential and such a method of exploiting groundwater makes maximum use of local materials and community participation. Where unprotected wells are already being used by a community the transmission of Guinea worm larvae is a risk, and proper protection of those wells, or construction of new wells, is the obvious choice of technology. The use of a bucket and windlass, or a 'shaduf' reduces the risk of water pollution by users.
- Where a sustainable handpump acceptable to the community is available, hand dug wells should be covered and water should be withdrawn using the handpump because this reduces the opportunities for the well water to become contaminated. However facilities for water to be withdrawn from the well by bucket should also be provided for use in an emergency. The simple, easily maintained, direct action type of handpump has great potential for most hand dug well since the pumping lift usually does not exceed 15m. Where the community being served by the well is less than 60 the Blair bucket pump is an alternative which should be considered.
- Where there are more than one protected source in a community, such that the very occasional failure of one handpump on one source would not mean people had to return to polluted traditional sources, the 'cased well' design or 'partially lined well' design should be considered since these use considerably less materials than fully lined wells. Both types of wells are suitable for handpumps or the Blair bucket pump. The 'Modified Chicago Method' of temporary support can be very cost effective in the construction of such wells.

- Powered drilling rigs for constructing boreholes need to be chosen with care to find a type most appropriate to the field conditions. Relatively simple, lightweight, cheaper rigs are now available which have the potential for much cheaper unit borehole costs. Their manoeuvrability often means that boreholes can be drilled in remote places inaccessible to the heavier rigs.
 - There are a vast number of different handpumps available on the market but also a number of sources of useful advice and the results of field tests to enable a wise choice to be made for particular field conditions. Undoubtedly the suitability of a pump for village level operation and maintenance (VLOM) is very important. Of equal importance are the standardisation in any one country on just a few models of handpump, and the in-country manufacture of the pumps, or at least the commonly needed spares.
 - The use of plastics for handpump components in corrosive groundwaters offers many advantages and is very cost effective compared to the alternative use stainless steel. The successful use of plastic rising mains, particularly with open top handpump cylinders has already been proven in the field, and current research should shortly produce improved connectors which will allow the pipe sections to be easily separated when necessary. Direct action handpumps which often have only plastic components below ground are suitable for use in virtually all situations where the water lift does not exceed 15m. The use of stainless steel rods and plastic rising mains with deepwell pumps is also now well tried.
 - The simple, relatively inexpensive and easily maintainable Blair bucket pump is worthy of consideration where the number of people relying on a source is less than 60 and the lift is less than 15m. The low daily demand from such a group may extend further the type of strata which can be considered suitable for yielding groundwater. If due to the convenient location of the borehole people are willing to spread their demand throughout the day, avoiding sustained peak use, the pump could be used on a very slow yielding borehole.
 - The use of a shaduf with the Blair bucket is potentially very cost effective but to date has not been tested in the field.
 - Where the aquifer appears to be suitable for their use, the potential for directly installing the types of open top cylinder handpumps which have extractable foot valves should be investigated. Such a method of installation dispenses with the need for a large diameter borehole casing and can therefore be very cost effective.
 - There is a wide variation in the way in which different projects calculate unit costs, and caution is needed when considering costs in isolation from full details of their basis.
- Rainwater** is pure, and if collected from an elevated surface such as a roof and stored in an hygienic manner it is usually suitable for drinking without treatment and offers no risks of the transmission of Guinea worm disease.
- The main disadvantage of its use is that there is usually a need to store a large volume of it for consumption during periods when there is no rain. If only water for drinking purposes is stored and traditional sources are used for other purposes the volume of storage is greatly reduced.
 - If rainwater is captured from the roof of the user's house there is the advantage that the storage can be placed conveniently close to the point of use and if the storage is above ground, the water can be collected hygienically from a tap or hose.
 - Where roofs to buildings are not suitable, cheap temporary catchments of woven plastic sacks may be feasible.
 - The annual rainfall figures for many of the areas of countries in West Africa where Guinea worm is endemic are high enough

to suggest that rainwater catchment is a potential source of potable water.

- Simple cement jars with hygienic draw-off hoses can provide cost effective potable water supply.
- Where the materials are available in the country the use of galvanised iron sheets and galvanised wires for the DANIDA design of suspended gutters is likely to be cost effective.

Surface water is usually of poor bacteriological quality and whenever possible an intervention which removes the risk of faecal pathogens as well as infected copepods should be used.

Of the interventions which mainly address only the problem of copepods the most effective relate to the separation of people from the source.

- There is a need for physical barriers and the acceptance by everyone of a community rule that no one enters the water but that it is drawn only from a dedicated point.
- There are three preferred methods of drawing water at this 'dedicated' point, described in order of preference. The first comprises a sustainable handpump and floating intake. The handpump can either be directly connected to the floating intake or it can draw water from a well-like reservoir in one of the banks which receives water from the intake.
- Secondly the use of a shaduf or other bucket and rope method from a vertical abutment with a surface which drains away from the pond is recommended.
- A final option is the use of a hand held bucket dipped into the water from a platform or ramp close to the surface of the source.
- In order to give a good level of protection against copepods the three recommended options can be modified by the use of strainer material. Either the floating intake can be protected by a box of straining mesh, or, adjacent to the access platform, an

open topped strainer box can be used. This box floats in the water with straining mesh on its sides and base so that water drawn from within the box when users dip their buckets into it is automatically strained (Neither of these two suggestions are known to have been tried so they both need to be field tested to discover how effective and sustainable they are.)

- Where necessary and feasible chemical insecticide (Abate) can be used if its application is properly managed

Of the interventions which provide copepod free water of reasonable or good bacteriological quality, depending on the field conditions, the following methods are recommended.

- Convert stepwells to protected draw wells or to wells equipped with a handpump (if a sustainable handpump is available).
- Collect water which is naturally infiltrating near to water sources or collect water from man made infiltration systems.

The interventions available after the water has been collected include straining, storage and treatment.

- The straining of water before consumption is recommended if other water treatment methods which remove most bacteria as well as copepods are not feasible. This straining is particularly appropriate where people need to consume water away from their usual protected source.
- Settlement, long term storage and straining using vessels in the home can lead to a greatly improved bacteriological quality to the water and this should be field tested. Cement mortar jars are suggested to be ideal containers and they could be sold with purpose made strainers, and taps or pipes for hygienic withdrawal of water.
- The use of locally available coagulants could be promoted to lead to an even better quality of water from the system just mentioned but this needs further study in the field.

- It is considered doubtful whether domestic or pond side slow sand filters can be properly sustained to produce water of good quality but their use would lead to some improvement in the quality of the water.
- Solar disinfection does work during periods of bright sunshine and in the absence of other methods of improving the bacteriological quality of the water it could be field tested to see how it works out in practice
- Chemical disinfection at a users home is not considered to be sustainable.

Other points regarding surface water include:

- Improvements to the ground level catchments areas which contribute to rain fed ponds will lead to a better quality of water in the pond. These improvements include fencing, interception and diversion of surface water from outside the catchment, settlement and the use of gravel filters.
- Where sustainable suction pumps are not available it may be possible to convert direct action and deepwell pumps to allow them to be used as offset pumps for drawing water from floating intakes or bed infiltration systems.
- Where man made infiltration systems are to be used in static water bodies, or where slow sand filtration systems are to be used, it is recommended that the feasibility of using one or more mats of open weave filtering fabric on the surface of the filter is investigated. This has the potential to simplify the cleaning process and can lead to improved lengths of filter run and a shorter 'ripening' period after filter cleaning.

The **Conclusions And Recommendations** of the study are that there is a large range of cost-effective technologies available for water supply in Guinea worm endemic areas.

For the sake of long-term consumer understanding and health promotion it is recommended that wherever possible assistance

should be aimed at providing potable drinking water, not just water free from infective Guinea worm larvae.

The results of the research indicate that the issue is not primarily the determination of a *cost-effective technology* but rather the *choice of technology suitable for a particular location*. This is of vital importance to achieve lifecycle cost effective technologies which are necessary to ensure sustainability.

Locations differ according to socio-economic, hydro-geological and hydrological conditions. To obtain the most suitable *choice* the community/household/consumer need to be involved in an education, information and communication process that will enable users to make their own choice according to their understanding of improvements in health and convenience and according to their willingness to pay for sustaining those improvements.

The desired rate of implementation can be achieved only by innovative use of promotion and marketing campaigns not normally associated with 'civil engineering products'.

Cost effectiveness of implementation is likely to be enhanced by the encouraged involvement of private sector suppliers.

The starting point for upgrading to potable water free of Guinea worm is normally to improve existing water sources, though the protection of potable water is difficult with surface water sources.

Life-cycle cost effective technology choices: Groundwater

When making *choices*, the exploitation of *groundwater* is normally the first priority since it can often supply sufficient quantities of good quality water.

Within this category every effort should be made to cap any spring sources (and where possible to pipe the water to a number of more convenient collection points)

If there are no springs and communities are scattered but groundwater is relatively shallow,

a number of hand drilled/hand dug wells with Blair type bucket pumps should be promoted. Where population density is higher the same technologies can be used with direct action handpumps.

If the ground conditions make it necessary, powered mini-rigs are applicable with deepwell open top cylinder pumps for water collection from beyond 15m depth.

Life-cycle cost effective technology choices: Rainwater

Where groundwater cannot be exploited, rainwater catchment using roof catchments with supported 'V' gutters and cement mortar jars can be promoted to give a good quality of potable water. Nylon sack catchments can be used where there are only thatched roofs.

Life-cycle cost effective technology choices: Surface water

Where there is no alternative but to use existing surface water sources, strainer boxes can be used to prevent Guinea worm as an interim measure even where there are no pumps.

The next stage of improvement for surface water is to use hand powered suction pumps with floating intakes protected by strainers.

Neither of these methods remove pathogenic bacteria so they should be promoted in conjunction with household cement jars for storage (with strainer covers as an added precaution). Any length of storage will begin to reduce the risk from pathogens not removed by straining.

Surface water sources should be upgraded to infiltration galleries or river bank wells to ensure potable water at the earliest opportunity.

Portable, individual strainers have a vital role to play as back-up to the other methods of preventing the ingestion of Guinea worm larvae and these can be used by people moving away from protected household sources.

CONTENTS

1. INTRODUCTION

Terms of Reference of Study
Work carried out
Introduction to Guinea worm

2. DIFFERENT WATER SOURCES AND THE RISKS OF GUINEA WORM TRANSMISSION

Consideration of various water sources and the associated risks of Guinea Worm transmission

Recognition of water supply technologies that always give copepod free water groundwater from protected sources rainwater from protected catchments stored in a protected tank

3. COST EFFECTIVE GROUNDWATER EXPLOITATION

Consideration of cost reductions in exploitation of groundwater:

- springs
- hand dug wells
- lower cost boreholes
- jetting
- hand augering
- appropriately sized rigs
- rising mains as permanent borehole casing
- lower cost handpumps
- plastic rather than stainless steel in aggressive water
- direct action rather than conventional
- Blair 'bucket pump', use with shaduf

4. COST EFFECTIVE RAINWATER EXPLOITATION

Consideration of cost-effective technologies for rainwater catchment

- community systems or household systems
- use only for drinking water
- roof catchments
- temporary catchment surfaces (e.g. stretched woven polypropylene sacking)
- mortar jars
- wire reinforced mortar
- ferrocement tanks
- ground level catchments

5. COST EFFECTIVE IMPROVEMENTS TO SURFACE WATER AND

UNPROTECTED GROUNDWATER SOURCES

Consideration of the various technologies and community practices which can be used to improve the water from existing sources

- community rules to only allow uninfected people into the water
- physical barriers or methods of collection which prevent, or make it unnecessary for anyone to enter the water
- fences
- platforms
- conversion of step wells to draw wells
- water lifting devices
- straining out the copepods
 - at the source(s)
 - at home
- chemical treatment
 - of the source(s)
 - at home
- fish as copepod predators
- boiling
- infiltration systems
 - protected wells in river/pond banks
 - infiltration systems in river/pond beds
 - groundwater dams and sand-storage dams
 - infiltration using suction pumps (e.g. SWS filter)
 - use of geotextiles in pond infiltration systems
- filtration systems
 - slow sand filter near to source
 - domestic sand filters
 - use of geotextiles
 - long term storage
 - solar disinfection

6. CONSIDERING THE COMMUNITY

Consideration of how the community's views affect the adoption of improvements and new technologies

7. CONCLUSION AND RECOMMENDATIONS

Recommendations of cost-effective technologies to be used on a large scale in selected countries

For the sake of those who do not have a background in the subject the following sections of the report includes some basic background information about the occurrence and exploitation of water sources which will be well known to other readers.

1. INTRODUCTION

1.1 Background To The Report

This report has been carried out under terms of reference drawn up by the Water and Sanitation Section, UNICEF, New York (Appendix I)

The terms of reference brought particular attention to the need

'to investigate alternative low cost technologies [for providing improved drinking water sources] that can be used in isolated communities and areas with difficult hydrogeological conditions in order to reduce per capita costs which should not exceed US\$30 per capita (low cost rural water supply systems at present average US\$20 per capita). These technologies have to be easily replicated on a large scale and, if [Guinea worm] eradication is to be achieved this decade, appropriate low cost water supply services have to be provided as quickly as possible'

The terms of reference give the overall purpose of the report as being

'To investigate and propose low cost effective methods to provide clean drinking water to guinea worm endemic areas in Africa. The results of the findings will be used to develop suitable projects in a selected number of guinea worm endemic countries.'

The terms of reference were slightly amended during the writing of the report, particularly in the light of the discussions at the Technical Support Team for Dracunculiasis meeting in Annecy, France, 24 - 28 August 1992. These amendments include the omission of a study of solar powered systems and the omission of the detailed project proposal for follow up action to field test the different technical options (Section 3.3 of the terms of reference).

A detailed section on low cost methods of exploiting groundwater, which was not included in the areas of technologies to be considered in the terms, has now been included in the report. The date of submission of the report was also changed although the period of the consultancy remained at seven weeks.

Methodology

Guidelines on the suggested methodology for the preparation of the report were given in Section 4 of the terms of reference have generally been followed except that no visit was made to the International Reference Centre, The Hague. This was considered unnecessary since literature references were obtained from a search of their computerised data base.

In addition to obtaining information from Global 2000, Peace Corps, CDC, USAID (Water and Sanitation for Health Project) which were suggested in the terms of reference the authors have consulted WaterAid, SKAT, ODA, various UNICEF staff and a number of manufacturers and researchers. The help of all these people is much appreciated and sources of information obtained from them are referenced in the body of the report.

A postal survey was also carried out in West Africa among interested parties but full results are not yet available.

Problems Experienced Obtaining Relevant Cost Information

One of the biggest problems experienced during the short period allowed for the production of this report has been the difficulty experienced in obtaining suitable cost data for the technologies being investigated. Unfortunately this means that it has not been possible to give indicative costs for some of them although they appear to be low cost technologies.

However there is a danger in being too focused on a 'typical cost per capita' figure for any of the technologies because in practice these may vary quite widely between programmes and will almost certainly vary between countries. These variations are due to a number of factors including the specific site conditions and method of construction, the availability of materials and skilled labour, and the number and density of distribution of sites in any one programme. Such variations can be noted in the wide range of costs which have been obtained from different sources for the drilling of boreholes, and which are quoted in Section . With some of these costs and those for some of the other technologies it is often not clear on what basis the original source calculated the figure. For example different projects are likely to be using different ways of:

distributing programme overheads including costs of expatriates;

the costs of other very important components of water supply projects such as health education and community mobilisation;

allowing for the 'cost' of donated materials and labour;

allowing for the amortisation of plant and vehicle costs;

Such problems have been recognised for some time and global standardisation of costing procedures to overcome many of these differences is being addressed by the Water and Environmental Sanitation Section at UNICEF New York. However the WESCOST computer programme recently developed to allow realistic comparisons of unit and per capita costs has not yet been fully field tested and no comparative costs for any of the technologies examined in this report are currently available.

In the absence of suitable cost data for a country the only option is for a programme manager to work with some communities to set up some small pilot projects to test out the technologies at a few sites to establish:

some idea of the suitability of the technology for the field conditions;

the likely rates of completion;

the level of health education and community mobilisation needed;

the requirements for labour, transport and materials;

the logistics of managing the programme;

the unit costs and per capita costs;

the community's acceptance of the technology and their motivation to contribute labour and materials or money to the construction of a protected water source.

Fortunately the capital cost of the pilot testing of the technologies discussed in this report will not

be very high since the equipment necessary is usually not very expensive and in the case of the simple powered drilling rigs is only moderately expensive.

Life Cycle Costs

The US\$30 and US\$20 per capita figures quoted in the terms of reference are the initial investment costs for water supply technologies. The initial investment costs are only one aspect of the costs of a technology. When making an economic choice between different technologies it is also important that the annual running costs and the replacement costs are also considered especially if the community is expected to bear these costs. Here again the programme manager will often meet the problem of the usual lack of information about life expectancies and maintenance costs for much of the hardware used with low cost water supply technologies and suitable discount rates to apply to the calculations, but some attempt needs to be made to consider this aspect. Unfortunately there has not been time nor the raw data to allow this to be attempted in this report.

Experience From Existing Projects

For some of the technologies it may be possible at an early stage to liaise with programmes elsewhere in the world who have already used them. This will enable managers, health educators and technologists to gain useful ideas which have already been learned by others, and help them to avoid mistakes made by others. Training of key workers for a new project by those working in an existing project will also be valuable where a new technology is being introduced to an area.

1.2 The Importance Of Potable Water

The transmission of Guinea worm disease can be prevented by interventions which do nothing to improve the usual poor bacteriological quality of the water. Such faecally contaminated water is contributing to many other diseases, and even deaths in the community.

The report includes sections that give suggestions for interventions which reduce the transmission of Guinea worm disease without much, or any improvement in the bacteriological quality of the water. The authors are of the opinion that while in the very short term

methods which only strain out, or kill, the water fleas (copepods) which carry the disease may be needed the provision of a potable water sources should be an urgent priority. It should be noted that although the straining and use of insecticide may lead to the eventual elimination of Guinea worm disease these interventions will have to be followed at some stage by the provision of a potable water supply if the level of health in the community is to rise appreciably. If a potable water source can be quickly supplied then the costs of many of the straining and insecticide interventions can be saved.

Health education is of course needed with both a temporary intervention and with the more permanent intervention of a clean water supply. However in the case of straining and insecticide interventions the community can not be taught to drink water from a potable source because there is none. Some difficulties may subsequently arise if at a later stage if for example they are told by health educators that the strained water from the pond which they were at first encouraged to drink is not after all good for them but that they should instead get their drinking water from a new potable source. In some parts of India women have been observed straining borehole water through cloth, a habit taught to them to strain out copepods when drawing water from the old stepwells. There are no copepods in the groundwater from the handpump so straining is unnecessary, and indeed it can be detrimental to the quality of the water if the cloth is not kept clean.

Previous Work On Cost Effectiveness

Three previous reports on cost effectiveness and cost-benefit of Guinea worm eradication interventions were consulted during the preparation of this report (Paul et al (1986), (Paul (1988a), Paul (1988b)). One report which compares costs of rainwater harvesting in five African countries without specific reference to Guinea worm was also consulted (Lee & Visscher (1990)).

Pauls work is based on the development of a PC-based spreadsheet software which was field tested in Pakistan. It is reported that it can be adapted by a computer programmer to suit the particular conditions of any country. The cost-benefit analysis (CBA) compares the full costs of a method of intervention (over a period of years

for a certain defined disease prevalence) with the value of the expected benefit. The latter is based on the product of the number of days people would have previously been out of action because of Guinea worm disease and the per capita per day agricultural productivity figure. However Paul notes that other benefits such as increased school attendance will also result from the eradication of the disease.

Comparison between the theoretical benefit-cost ratios calculated by the software for different interventions can aid a programme manager to choose between them. Sensitivity analysis allows the effect of possible errors in the assumptions made when inputting data to be examined.

The study in Pakistan describes the assumptions which had to be made and qualifies the results. These show that for the three different provinces studied the BCR for various different interventions varied from 0.48 to 1.53. However improved drinking water systems only comprised a low proportion (0 - 10%) of the interventions being studied in any province and in each case only 40% of the cost of the water system was used in the CBA. The 40% factor was used the improved water intervention has many benefits in addition to the eradication of Guinea worm disease whereas the other interventions (the use of straining mesh and chemical insecticide) related purely to the elimination of the disease.

Lee and Visscher (1990), when looking at Botswana, Kenya, Mali, Tanzania and Togo calculate the annual equivalent cost (AEC) per m³ supplied from rainwater catchment systems and water from some other sources. Lack of specific data meant that some very generalised assumptions had to be made with regard to the amount of water used from each type of system, their life span and their running cost. Their cost comparisons between countries demonstrate a wide range of costs, probably partly due to the problems of differences in the costing basis used by the sources from which they obtained their raw data. When comparing costs in just one country they conclude that in Botswana rainwater catchment can often compete with other sources, and in Tanzania its cost is comparable to diesel powered borehole supply systems.

1.3 Guinea Worm Disease

Background

Guinea worm disease (dracunculiasis) currently affects an estimated 3 to 5 million people per year (CDC 1991), mostly from seven African countries (Figure 1.1) but also in some parts of India and Pakistan. It is caused by a parasitic worm *dracunculus medinensis* which is carried in a cyclopid copepod (a small water flea 1-3mm long sometimes referred to as a cyclop) and it can only infect a person if they drink water containing a copepod which is harbouring the infective stage of the parasite.

People rarely die from the disease but the fully grown worm incapacitates its victims for four to six weeks, or sometimes longer. This means that infected men and women cannot work in the field, infected children cannot attend school and infected mothers can not care properly for young infants. Earnings, learning and good nutrition can therefore all be undermined by the disease.

There is no vaccine that can prevent the disease. It can not be treated in a person by use of a drug although recently it has been discovered that some relief can result from the early removal of the live worm by making a small incision and carefully removing it from below the patients skin.

The disease in theory can be prevented relatively easily by interventions that break the yearly cycle of its transmission. All of these interventions, other than surgical removal, relate to the source of water. This report considers all the different forms of intervention either at the water source or after the infected water has been carried home.

The cycle of transmission

During the one-year incubation or growing period in the human host, the adult female worm moves to a position under the skin of the afflicted person. Then the parasite causes a painful blister to form, usually on the lower leg or foot. When the person immerses the affected body part in water, the blister breaks, and the worm is exposed releasing hundreds of thousands of tiny first-stage larvae into the water. The adult female worm is capable of releasing larvae on repeated exposures to water.

Some of the larvae deposited in the water are ingested by the copepods where they live and develop into third-stage larvae after 10-14 days. Only these third-stage larvae are infective to people.

After people drink water containing infected copepods, gastric juices in the stomach kill the copepods, allowing the infective larvae to escape. These larvae migrate to the small intestine, penetrate through the intestinal wall and live in the abdomen. Male and female larvae reach maturity after about 90-120 days, when mating occurs. Thereafter, the female continues to grow into an adult worm. During this time the adult female moves towards the lower limbs and emerges after about 10-14 months.

It usually takes several weeks for the afflicted person to completely extract the worm. During this time the person is disabled or in pain, often from infection resulting from the worm as it emerges from an abscess or from inflammation of the joints. Secondary bacterial infections are common and usually prolong and complicate recovery. Tetanus can develop, as well as frozen joints and permanent crippling. The worms do not survive in people for more than one year. They either surface through the skin and are extracted, or die inside the body.' (CDC 1991)

No immunity to dracunculiasis develops and repeat infections are common. No animals other than man have been shown to be important natural hosts of the Guinea worm although many can be experimentally infected in the laboratory (Muller, 1985).

The life cycle of the Guinea worm is well illustrated in Figure 1.2.

Interventions in the cycle of transmission

The six main points of intervention in the cycle are illustrated in Figure 1.3. These are discussed in later sections of the report. Briefly they are:

providing water which can not sustain copepods. For example this could be a new protected groundwater source.

Avoiding the contamination of the water by Guinea worm larvae. This can be achieved only if the whole community change those practices

1.2

Life Cycle of the Guinea Worm

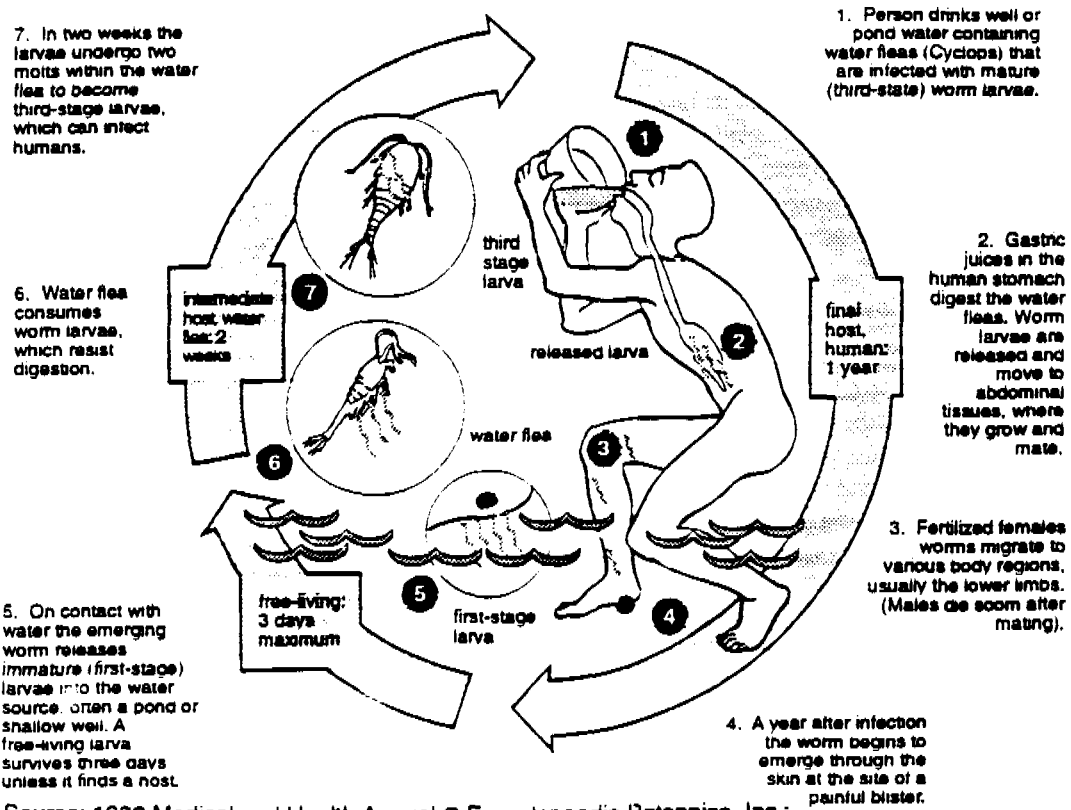

Source: 1992 Medical and Health Annual © Encyclopaedia Britannica, Inc.; illustration by John Draves

1.3

D. medinensis Life Cycle Points of Intervention Against Dracunculiasis

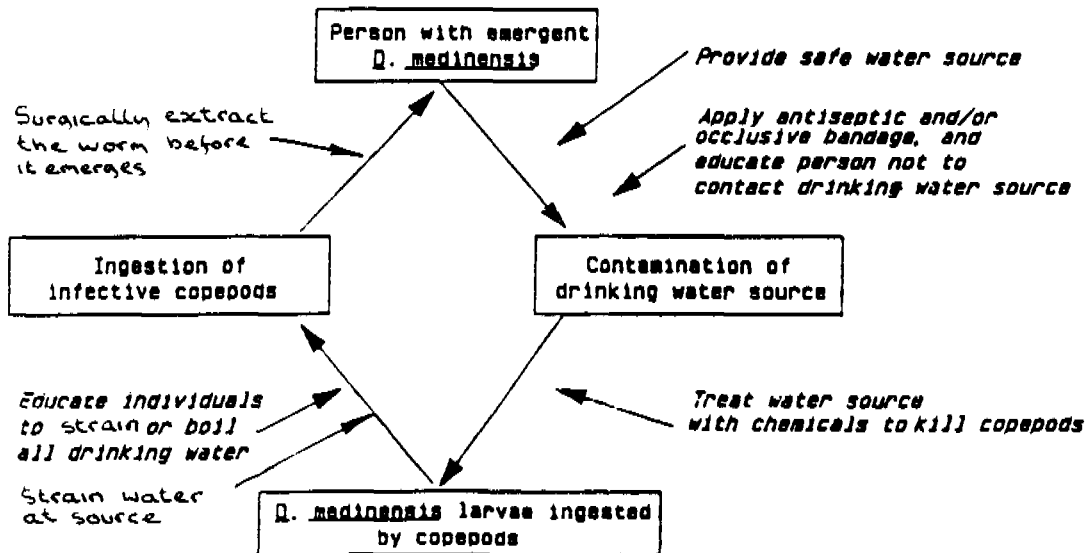

which previously led to them coming into contact with the source water and thereby contaminating it. It needs one person carrying a Guinea worm lesion which comes into contact with the source to infect a large number of copepods and restart the disease cycle. However such measures are better than nothing. Occlusive bandaging can also reduce the risk of larvae from an infected person reaching the water.

Treating the water source with chemicals. The use of chemicals, particularly temephos (trade name Abate) to kill all the copepods and larvae in the source water is a widely used intervention. However achieving the required concentration of Temephos in the source at the regular intervals needed during the transmission season is not very easy. Where the source is very large, or where there are a large number of small sources treatment by this method often becomes impractical

Straining the copepods out of the water source as it is collected. If a well on the bank of a pond collects water from an infiltration system the infected copepods (and many other pathogens) will be strained out of the water before it enters the well so there is no risk of people ingesting infected copepods. Likewise if the water passes through a fine strainer before it is collected from a source then users are protected from Guinea worm disease (although they may ingest a number of other pathogens).

Straining the copepods out of the water at home or killing them by boiling drinking water. If people always strain their drinking water through a finely woven cloth or through a suitably fine mesh the copepods (although very few of the other pathogens) will be removed from the water and those who drink the water will be protected from infection. They can also kill the copepods (and other pathogens) by boiling all drinking water.

Removal of adult worms just before they emerge. As mentioned above the practicality of this is only a recent discovery and it is not yet widely practised and it has been added to Figure 1.3 by the present authors. Obviously if the worm is removed before it can release larvae there is no risk of the copepods ever becoming infected by that worm.

Important aspects about the life of copepods
Guinea worm disease is a seasonal disease and the implications of this on various interventions is discussed further in parts of Section 4 and 5. The seasonal nature is partly due to the water drawing habits of users which vary from season to season but also in part due to the conditions under which the copepods survive. Their biology has been studied by a number of researchers particularly by Onabamiro in Nigeria and by Muller and some aspects of this are relevant to this report.

Muller (1971) has noted that a larva usually moults a second time 12-14 days after being ingested by a copepod if the water temperature of the pond water is between 25°- 30°C. A few days after this moulting the third stage larvae becomes infective to a person who ingests the copepod and larva. Apparently outside of this range of temperatures the time required for moulting lengthens and the survival rate of infected copepods falls off radically (de Rooy, 1992). In many areas of Nigeria the harmattan winds in January - February cool off the ponds and virtually stop transmission (cit.ibid).

As discussed later in this report Muller (1985) has also noted that copepods do not usually colonise draw wells provided the diameter is less than about 4 metres. This is probably due to the lack of enough light for the growth of the algae and protozoa on which they feed. Copepods are not usually found in fast flowing water.

He also notes that copepods which contain third-stage larvae become sluggish and sink nearly to the bottom of a pond or step-well (Muller, 1985). The implications of this for on the way in which water is collected from a source is discussed in Section 5.

Quality and quantity of water resulting from an intervention

As noted above, a number of the interventions which can be used to help eradicate dracunculiasis do nothing to improve the bacteriological quality of the water and although after the intervention the water will not harbour infected copepods it will most likely contain a number of other pathogens harmful to those who consume the water. Wherever possible an intervention is chosen which will remove or

certainly drastically reduce these other pathogens so that instead of only eradicating Guinea worm disease other illnesses in the community can also be reduced. However, as discussed in Section 2, it is recognised that the faecal pathogens found in water (which are the source of many common illnesses in developing countries) are also ingested via other routes so only addressing the quality of the water is not a sufficient intervention to lead to a drastic reduction in many of these other disease.

If the intervention chosen for the eradication of Guinea worm also leads to a more convenient source of a greater quantity of water than before then considerable health benefits will result even though the water is still to some degree bacteriologically contaminated. This is because a higher quantity of water usually leads to a higher standard of hygiene which eliminates many of the other routes of infection by faecal pathogens (Feachem, 1980). The avoidance of the faecal contamination of potable water in a home is discussed in Section 2.

Convenience of new protected water sources
One area that needs careful consideration when providing a new or improved source of water to prevent people becoming infected with Guinea worm is the convenience of the new source or the method of collecting water. Unless extensive appropriate health education leads to a change in attitudes people will use unprotected traditional sources if they are more convenient than the new source. If the traditional source can be protected in a way acceptable to the community then this becomes less of a problem and the improvements at traditional water collection sites is often the best starting point for an intervention.

With scattered communities which are using numerous traditional sources the centralised provision of an improved source may therefore not be a solution to the problem of providing copepod-free water. The provision of a greater number of smaller convenient sources (such as shallow hand augered boreholes or shallow wells with simple water lifting devices, or domestic rainwater catchment systems) should be seriously considered in these situations, even if they can only be schemes suitable for providing just the potable water component of domestic demand.

The problems of people who need to consume water whilst away from home and away from any protected sources provided for domestic use needs to be addressed. This applies equally to people who are away for a few hours as to those who seasonally migrate, for example to work in distant fields. This problem can only be addressed by appropriate health education to make people aware of the risks of infection from all unprotected sources to encourage them where possible to carry potable water from home to the field or to take small straining devices to at least protect themselves from dracunculiasis. Where a number of farmers recognise the importance of potable water it may eventually be possible to construct small protected sources in the fields. People visiting friends or markets away from home need to understand that they must at all cost avoid consuming unfiltered water. If people do not understand these risks they may become infected away from home and come to the conclusion that the interventions carried out at home, or in their villages, do not work and that any effort necessary to make the interventions work may then be considered useless.

It is important that before any intervention takes place that the programme designers are fully aware of the possible variety of existing water drawing practices used by people in a community throughout the year so that the interventions can be properly targeted.

The Community and Health Education
From what has been said so far it should be clear that technology alone, even if it is cost effective, is never going to lead to the elimination of Guinea worm disease. All interventions must go hand in hand with appropriate health education based on a proper understanding of the community. We will return to this theme many times during this report but as discussed in Section 6 this subject has been well covered elsewhere and these aspects are not examined in detail in this report.

1.4 Guinea Worm Disease Transmission Seasons in Africa

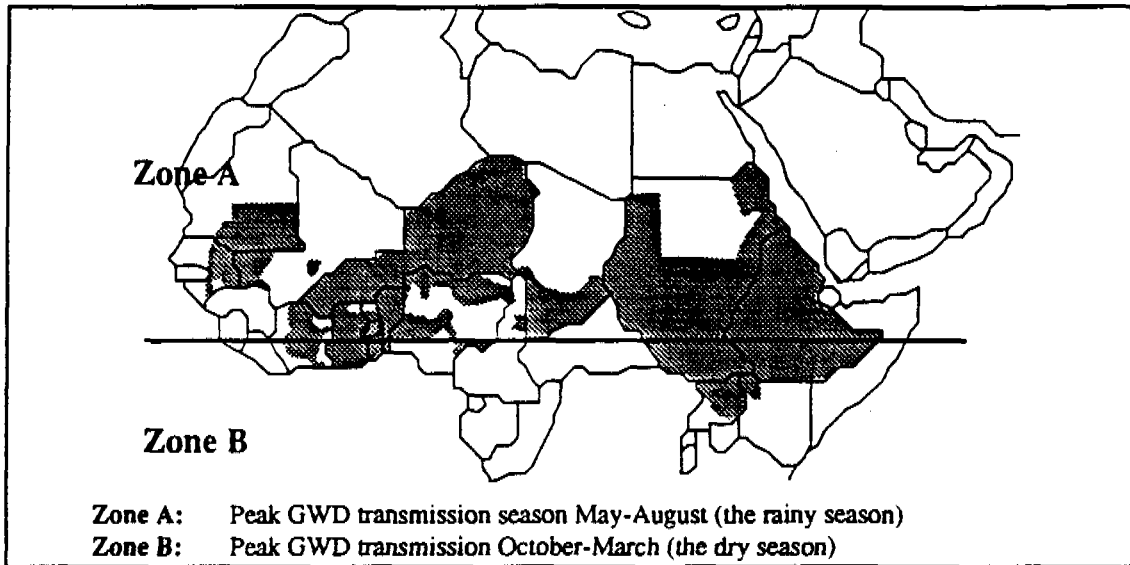

Adapted from: Guiguemde, T.R. 1986. Caracteristiques climatiques des zones d'endemie et modalites epidemiologiques de la dracunculose en Afrique. *Bull. Soc. Path.* 79:89-95.

2.0 WATER SOURCES AND THE RISKS OF GUINEA WORM DISEASE (DRACUNCULIASIS) AND OTHER DISEASES

SECTION SUMMARY

- Rainwater from roofs which is stored in covered containers from which the water is drawn hygienically offers no risk of Guinea worm transmission and little or no risk of transmission of other pathogens;
- Groundwater from a protected source, if collected in an hygienic manner, offers no risk of Guinea worm transmission and little or no risk of transmission of other pathogens;
- Fast flowing surface water sources offer no Guinea worm transmission risks. Other surface water sources have a varying level of Guinea worm transmission risk but this can be made minimal if the water can be collected without people entering it, *and* water which splashes against people who draw it is prevented from draining back into the source.
- Untreated surface water sources usually contain pathogens from human faeces;
- The quality of drinking water supplied by a source is not the most important factor in the fight to reduce the transmission of common diseases.
- Sufficient quantity of water needs to be made conveniently available for domestic and personal hygiene but this water does not need to be of a very high quality. People need to understand and practice personal hygiene. Households need to understand, and practice, hygienic methods of collecting, storing and using drinking water from a protected source to prevent the water becoming contaminated before it is consumed. Communities need to adopt appropriate sanitation methods to prevent the spread of excreta related diseases.

- The three usual interventions which are designed to deal only with breaking the cycle of Guinea worm infection do little to improve the bacteriological quality of the water (Table 2.1)

Table 2.1 presents a simplified summary of the risks of transmission of Guinea worm disease and faecal pathogens.

Table 2.1 Advantages and disadvantages of the three main interventions for interrupting the cycle of transmission of Guinea worm disease, with particular reference to the resulting bacteriological quality of the water.

INTERVENTION	ADVANTAGES	DISADVANTAGES
<p>1. Preventing contact Prevention of infected people entering the water and contaminating it with larvae.</p> <p>For example:-</p> <ul style="list-style-type: none"> •Fencing or other physical filters barriers to prevent everybody entering the water and preventing any water which may come in contact with infected people from carrying larvae back into the source •Rules imposed by the community banning any infected person entering the water 	<p>Cycle of transmission of Guinea worm should be interrupted</p> <p>Also prevents people bringing other contaminants (eg. faecal matter) into the water</p>	<p>It only needs one infected person to bypass the barrier or break the rules to start the cycle again.</p> <p>The whole community must understand and cooperate.</p> <p>Some water collecting device acceptable to the community is needed (eg. shaduf, bucket and rope, handpump)</p> <p>Uninfected people need to be willing to draw water for the infected people.</p> <p>Uninfected people are likely to contaminate the water with bacteria and other pathogenic organisms when they step into the water</p>
<p>2. Straining Separating the copepods from water used for drinking by pouring it through a finely woven cloth or a monofilament mesh</p>	<p>Interrupts the cycle of transmission if used on every occasion. A fairly simple technique which can be adopted by individuals for use in the home or when in the field.</p>	<p>The straining will not remove pathogenic bacteria, viruses etc. but people may have a false sense of security that the water is safe.</p> <p>People need to remember to carry a strainer with them if they are going to drink water elsewhere.</p>
<p>3. Chemicals Application of temephos ('Abate') in particular to the source(s) of water used for drinking. Chlorine compounds and iodine have also been used.</p>	<p>Also kills off mosquito larvae which could transmit malaria</p>	<p>The chemical needs to be readily available, and to be added to the water body at suitable frequencies and in the right quantities to ensure the copepods are killed.</p> <p>Temephos does not kill pathogenic bacteria, viruses etc. but people may feel that the water is safe because it has been treated with a chemical.</p> <p>Where there are a large number of sources it is not practical to treat all of them.</p>

2.1 Water Sources, Guinea Worm Transmission And Water Quality

Mankind collects water from various points on the hydrological cycle which operates between water in the atmosphere and water on the earth. It is necessary to understand the relationship between the various water sources and Guinea worm disease and other diseases to ensure that improvements aimed at eradicating Guinea worm do not inadvertently lead to increases in other diseases.

2.1.1 Rainwater

This is one of the purest sources of water although it can be contaminated as it flows over the surface used to capture it. There are no risks of Guinea worm transmission related to its use for potable purposes until:

*it mixes with water already containing infected copepods or
it is stored in such a way that copepods can breed in it and the copepods can become infected by Guinea worm larvae*

The use of covered jars or tanks to store water collected from roofs offers no risks of Guinea worm transmission as long as a hygienic method is used to draw the water. The quality of rainwater from above-ground catchments is generally good with regard to bacteria and other pathogens. However the storage of such rainwater in open tanks and ponds has risks associated with it which are similar to those for ponds used for storing rainwater collected from ground surfaces.

If rainwater flows over ground surfaces before entering storage there is risk of Guinea worm transmission if the water passes through pools containing infected copepods or Guinea worm larvae. Even if the water is not infected when it enters storage, if copepods breed in the pond or storage tank, and if water is collected in a way which allows it to be infected with larvae, the source provides a transmission site. It should be noted that although larvae are bound to contaminate the stored water if people with Guinea worm lesions on their legs enter it there is also a risk where people do not enter the water. This risk arises if water which splashes

against a Guinea worm lesion is allowed to drain back into the source.

Even if there is no risk of Guinea worm transmission the bacterial quality of water is likely to be poor when collected from a ground catchment and this may lead to the spread of other diseases.

Although rainwater collected from an elevated surface may be potable, people who are previously used to different sources of water may dislike its taste and may initially reject it as a source of drinking water.

Rainwater needs to be stored so that it is available when there is no rain. If there is a long dry season the volume of storage required will be large. If the catchment surface is the roof of a house the storage can be very conveniently placed near to the home. With an above ground tank water can be collected hygienically from a tap. Subsurface tanks require some lifting mechanism.

2.1.2 Surface Water

As rainwater runs over the ground it can pick up contaminants and once it has joined larger water bodies it can be further polluted by people using the water for different purposes. Usually it will contain pathogenic organisms originating from faeces, so some form of treatment is always advisable to prevent the spread of disease. However, small scale methods of treating surface water in rural areas of developing countries often meet with operational and maintenance problems.

Untreated water may also contain a quantity of suspended matter such as fine clay particles which affect the colour and taste of the water, but existing users of untreated surface water have often grown accustomed to these and do not reject the water on these grounds.

Copepods are not usually found in fast running streams and rivers (Muller, 1979) so the risk of Guinea worm transmission in such cases is low. However in slow flowing water copepods can be present and they can become infected by larvae from people with Guinea worm lesions. Even if one community draws water in such a way that they do not allow Guinea worm larvae to enter

the water, if the water is flowing they are at risk from infection from upstream users who contaminate the water with larvae. Where water is stationary the situation is similar to that explained above for rainwater storage ponds.

2.1.3 Groundwater

As polluted surface water infiltrates through granular soils and sub-strata to join the groundwater it filters out virtually all pathogenic bacteria and viruses. Groundwater is therefore usually of potable quality but it can be contaminated during collection, for example by the use of a dirty bucket and rope in a well which can lead to the contamination of the water. Covering the well and installing a handpump prevents this source of contamination but adds another problem since the handpump will need proper maintenance to be sustainable. Where suction handpumps are used it is important that the footvalve design is good or people may contaminate the pump by priming it with polluted water.

Occasionally some natural chemicals may occur in the groundwater at concentration levels which make the water unsuitable for human consumption, or which cause it to be rejected because of taste, colour or smell. Sometimes the water is 'hard' and it may be rejected by users because it increases the time, and therefore fuel needed to cook some foods and it increases the amount of soap needed to form a lather. In a number of areas in west Africa the groundwater can also be naturally corrosive and this creates problems where galvanised iron or mild steel handpump components are used because they can corrode and fail very rapidly.

Groundwater is often found in aquifers which extend over a large area so although sometimes efforts may be necessary to find the highest yielding site, often a well or borehole can be located conveniently close to the community that will use it.

Springs only occur in specific locations but they have the advantage that they can deliver water above ground. If the spring is on a hillside above a community they can be served by gravity through a piped system.

Groundwater offers no risks of Guinea worm transmission until it enters a pool or well where copepods breed and where Guinea worm sufferers can contaminate the water with Guinea worm larvae. Hence there is no risk of transmission in groundwater from protected springs, boreholes/tubewells or covered hand dug wells equipped with handpumps or from 'draw wells' (where water is collected in a bucket which is lowered from the surface on a rope) with parapet walls.

Where open wells are not properly constructed and Guinea worm larvae from users can enter the water, there is a risk of transmission only if copepods live in the water. Interestingly, it seems that copepods do not usually survive in the water found in most draw wells. Muller (1985) reports that due to the absence of enough light for the growth of the algae and protozoa on which the copepods feed "they are not usually able to reproduce in draw wells, provided the diameter is less than about 4 metres" but no confirmation of this has been found in other references. There is a great risk associated with 'step wells' which are a type of well where people descend a path or steps into an excavation to draw water by dipping a container into, or even sometimes entering, the well water.

2.2 Transmission Of Diseases Other Than Dracunculiasis

2.2.1 Faecal Contamination In The Home

The risks of contamination of sources of water by faecal pathogens has already been mentioned. Unfortunately the provision of good quality drinking water at a source does not necessarily mean that people using the source will drink good quality water because it can become contaminated by faecal pathogens at an number of points before someone drinks it. For example, it may be contaminated by a dirty container used to collect it from the source or to draw it from the storage container, or if poorly stored in the home it can become contaminated in other ways.

Appropriate health education is necessary before people make the changes in habit which are necessary to improve the level of domestic hygiene needed to maintain the quality of potable water until it is consumed.

Although this paper relates in the main to water supply and the transmission of dracunculiasis it must be recognised that improvements in water quantity, quality and water handling practices only go part way towards the reduction of diseases in a community. Because many of the water borne diseases caused by these pathogens are also transmitted by other routes, such as by flies or unwashed hands, only supplying uncontaminated drinking water does not necessarily lead to a dramatic reduction in their prevalence. It is necessary that appropriate methods of sanitation and good standards of hygiene are also widely adopted if the spread of excreta-related infections is to be reduced.

It has been noted that an increase in the quantity of water used for personal hygiene, even if it is not of a good potable standard can lead to a more general benefit than purely addressing the quality of the drinking water supplied. One of the main ways of increasing the quantity of water used is to make it more conveniently accessible.

2.2 Other Water Related Diseases

In addition to the risks of the transmission of Guinea worm disease and faecal pathogens mentioned above there are a few other disease risks associated with water sources which are of importance in relation to some sources of supply used in Guinea worm endemic areas:-

2.2.1 Malaria

Mosquitoes which transmit malaria from one person to another breed in stationary water. This is equally true for very small amounts of water as for the large volumes in water storage tanks. If it is planned to introduce open storage reservoirs to an area then the risk of increasing the spread of malaria should be investigated and minimised. For example, preventing the growth of weeds along the waterline can reduce the opportunities for mosquitoes to breed.

2.2.2 Schistosomiasis (Bilharzia)

Snails which form the intermediate host during the transmission cycle of schistosomiasis can breed in still or slow moving water. If they

become infected by the miracidia which develop from the ovum passed in the urine or faeces of an infected person the snails will later release many cercariae which can burrow into the skin of someone entering the water, or less commonly enter their bodies through the stomach when they drink the water. Where bilharzia is endemic in an area clearly there are risks associated with some surface water sources which need to be minimised.

3 COST EFFECTIVE TECHNOLOGIES FOR GROUNDWATER EXPLOITATION

SECTION SUMMARY

Groundwater exploitation has already played an important part in the eradication of Guinea worm disease from a number of places in the world. Groundwater has two main advantages:

- it is usually potable and free of any copepods to be infected with Guinea worm larvae. It does not usually contain faecal pathogens or other contaminants;
- aquifers are often extensive and in such cases it is usually possible to locate a well very near to a community needing water.

The main disadvantages of exploiting groundwater are:

- it can be difficult to excavate the hole necessary to reach the ground water. This problem increases as the depth to the groundwater increases and with the hardness of the sub-strata.
- except in the case of springs and artesian wells, some way has to be found to lift the groundwater up to ground level. This problem obviously increases with the height of lift required, and extraction using a handpump is increasingly difficult as the groundwater depth increases. Few handpumps are acceptable to communities where the lift is beyond about 45 metres below the surface and because of the increased forces on the components of such pumps they need to be very robust.

The most important observations and recommendations to arise from the section are:

- Where springs occur full use should be made of them. When they are properly protected they can supply potable groundwater, in most cases without the need for a pumping device. Cost effective spring protection designs which do not need spring boxes are available.

- Appropriate groundwater location techniques should always be used to avoid as much as possible the cost of wasted boreholes or wells;
- Hand-drilled boreholes have great potential where the strata is suitable. They are often more cost effective than hand dug wells but unlike draw wells they need sustainable handpumps for the withdrawal of water. The boring equipment is relatively cheap and usually very portable, and the community can be fully involved in its use for borehole construction.
- In a limited category of strata the use of wash-bored tubewells is very cost effective and it can lead to the very rapid construction of tubewells. The equipment is relatively cheap and easily transported but after completion the tubewell will need to be equipped with a sustainable handpump.
- In many cases low yielding strata, traditionally not considered suitable for groundwater exploitation, can be used to supply water to a community. This is especially true when hand dug wells are constructed but very low yielding aquifers can be exploited by a tubewell if it is designed to serve only a small population, such as would be the case when using the Blair bucket pump.
- Where the groundwater is not excessively deep, open hand dug wells have great potential and such a method of exploiting groundwater makes maximum use of local materials and community participation. Where unprotected wells are already being used by a community the transmission of Guinea worm larvae is a risk, and proper protection of those wells, or construction of new wells, is the obvious choice of technology. The use of a bucket and windlass, or a 'shaduf' reduces the risk of water pollution by users.
- Where a sustainable handpump acceptable to the community is available, hand dug wells should be covered and water should be withdrawn using the handpump because this reduces the opportunities for the well water to become contaminated. However

facilities for water to be withdrawn from the well by bucket should also be provided for use in an emergency. The simple, easily maintained, direct action type of handpump has great potential for most hand dug well since the pumping lift usually does not exceed 15m. Where the community being served by the well is less than 60 the Blair bucket pump is an alternative which should be considered.

- Where there are more than one protected source in a community, such that the very occasional failure of one handpump on one source would not mean people had to return to polluted traditional sources, the 'cased well' design or 'partially lined well' design should be considered since these use considerably less materials than fully lined wells. Both types of wells are suitable for handpumps or the Blair bucket pump. The 'Modified Chicago Method' of temporary support can be very cost effective in the construction of such wells.
- Powered drilling rigs for constructing boreholes need to be chosen with care to find a type most appropriate to the field conditions. Relatively simple, lightweight, cheaper rigs are now available which have the potential for much cheaper unit borehole costs. Their manoeuvrability often means that boreholes can be drilled in remote places inaccessible to the heavier rigs.
- There are a vast number of different handpumps available on the market but also a number of sources of useful advice and the results of field tests to enable a wise choice to be made for particular field conditions. Undoubtedly the suitability of a pump for village level operation and maintenance (VLOM) is very important. Of equal importance are the standardisation in any one country on just a few models of handpump, and the in-country manufacture of the pumps, or at least the commonly needed spares.
- The use of plastics for handpump components in corrosive groundwaters offers many advantages and is very cost effective compared to the alternative use

stainless steel. The successful use of plastic rising mains, particularly with open top handpump cylinders has already been proven in the field, and current research should shortly produce improved connectors which will allow the pipe sections to be easily separated when necessary. Direct action handpumps which often have only plastic components below ground are suitable for use in virtually all situations where the water lift does not exceed 15m. The use of stainless steel rods and plastic rising mains with deepwell pumps is also now well tried.

- The simple, relatively inexpensive and easily maintainable Blair bucket pump is worthy of consideration where the number of people relying on a source is less than 60 and the lift is less than 15m. The low daily demand from such a group may extend further the type of strata which can be considered suitable for yielding groundwater. If due to the convenient location of the borehole people are willing to spread their demand throughout the day, avoiding sustained peak use, the pump could be used on a very slow yielding borehole.
- The use of a shaduf with the Blair bucket is potentially very cost effective but to date has not been tested in the field.
- Where the aquifer appears to be suitable for their use, the potential for directly installing the types of open top cylinder handpumps which have extractable foot valves should be investigated. Such a method of installation dispenses with the need for a large diameter borehole casing and can therefore be very cost effective.
- There is a wide variation in the way in which different projects calculate unit costs, and caution is needed when considering costs in isolation from full details of their basis.

3.1 Exploiting groundwater found at ground level

Springs: Where the groundwater table intersects the surface, as in the case of a spring, it is very easy to reach the groundwater and if the site of the spring is conveniently positioned in relation to a community it is usually very cost effective to protect it to provide a potable source of water. Simple spring protection designs which do not use costly 'spring boxes' are suitable where the spring is flowing at a sufficient rate to satisfy peak demands [Skinner (1992), Rous (1985)]. Many springs can be protected using local materials, a short section of delivery pipe and 6-10 bags of cement (Figure 3.1.1).

Where the spring is slow flowing some form of storage with a supply controlled by one or more taps may be needed to satisfy peak demand. Often if sufficient storage is provided, then even a slow yielding spring can be exploited and ferrocement tanks can be a cost effective method of providing storage. Although the use of cement mortar jars (see Section 4.4.2) for spring water storage has not been noted in the literature studied there is no apparent reason why one or two large cement mortar jars should not be used for this purpose as long as there is sufficient slope to the land below the spring to provide for the height of the jar.

Where the spring occurs in an area where the ground has only a very shallow slope there may be insufficient height for the construction of a traditional headwall and spring outlet pipe but other methods of exploitation may be possible. For example the spring can be routed into a below-ground tank (which could be similar to a lined hand dug well) from where the water can be drawn using a suction pump or a bucket and rope. However since the surface gradients are slack and surface water runoff is slow it is very important with this type of spring that polluted surface water is prevented from contaminating the groundwater. In some places in Uganda an excavation in clay filled with stones and covered with a protective layer of clay has been used for groundwater storage with an offset SWS Rower suction pump (see Section 5.2) to allow its extraction (WaterAid 1992).

If a spring occurs on a hillside above a community then there is potential for a gravity piped supply to tapstands which can be located conveniently close to the community. The costs

of such schemes are very site specific and per capita costs are rather meaningless. Where such gravity supply schemes are possible they should be investigated because there is great potential for health improvements due to the improved quality and quantity of conveniently available water. Also the maintenance of the schemes can be simpler than that for handpump schemes. Where a community is very scattered a large number of tapstands are needed (to provide a suitable density of standposts to make at least one of them conveniently close to each user) and their cost and that of the associated piped distribution system is usually prohibitive.

Morgan (1990) shows that with some hand dug wells it is feasible to construct 'siphon wells' or 'gravity wells' to allow piped water to be collected as shown in Figure 3.1.2.

Artesian boreholes/tubewells: Artesian conditions can occur where an aquifer is confined between two impermeable strata and the piezometric head is above the top of the aquifer. If excavations (including drilling) reach such aquifers then the effort required to lift the water are reduced since it will naturally rise part way up the well. In a few cases the groundwater pressure is even sufficient to raise the water up to the surface and no pumping is required, but since such artesian conditions are rare they are not further considered in this report.

3.2 Finding Sufficient Groundwater

Unfortunately groundwater is not always available because some geological formations do not hold water or do not yield it at a sufficient rate to supply water to a community. Where groundwater is being extracted from an aquifer it is important that the strata is also receiving sufficient infiltrated water to replace what is removed or the groundwater level will fall. It is therefore important that wherever possible a hydrogeologist advises any project planning to exploit groundwater.

Groundwater is found in the pores between the grains of granular strata or in the fractures in weathered rock. The first mode of occurrence often exists over a large area and the exact siting of a well may not be very critical once a suitable area has been identified. However where the

water occurs in fractures the amount of water available is very dependent on the width and pattern of fractures and in certain situations two boreholes can be just 5m apart yet one can be dry and the other can have a reasonable yield. Recent developments in the use of hydrofracturing of dry or low yielding boreholes in fractured rock has been giving encouraging results. In India 1012 of 1350 previously unsuccessful boreholes gave acceptable yields after such treatment. The average cost of hydrofracturing per borehole was US\$200 compared to a drilling cost of US\$770 per borehole (Davis, 1992).

Cost effectiveness of groundwater exploitation depends upon the avoidance of dry holes or low yielding holes. In some countries a fairly reliable indication of groundwater fairly near to the surface is known to be given from the presence of specific types of trees which indicate that water is present at certain depths. Traditional 'water diviners' or 'dowsers' have sometimes proved to be reliable. Hand augering of small diameter exploration holes or the use of jetting probes are also possible for prospecting for groundwater at shallow depths. Blankwaardt (1984) notes that in Tanzania 30 - 40 survey boreholes of 100mm diameter can be drilled for the cost of just one hand dug well lined with concrete rings. He observes that since hand drilled boreholes are cheaper than hand dug wells, so an intensive survey using 100mm test boreholes to find a suitable site for a 230mm diameter hand drilled borehole is usually also very cost effective.

There are various other techniques a hydrogeologist can use to assist in the location of exploitable groundwater even if it is not at a shallow depth. These methods include on-site geophysical methods (e.g. electrical resistivity and electromagnetic methods) and remote methods (e.g. using aerial or satellite photographs). Some of the equipment is expensive and has high maintenance costs so methods of investigation can appear at first to be quite costly. However, de Rooy et. al. (1986a) found that the average cost of geophysical surveys to locate boreholes in basement rocks in Nigeria came to between 2.5% and 5% of the cost of the borehole. Jones (1987), also reporting experiences in Nigeria, notes that the cost of

equipment to check up to 30 sites per month was equivalent to the cost of two dry boreholes.

Avoidance of dry wells is only one aspect of the use of geophysical equipment. It is also useful in enabling well/boreholes sites to be chosen which will have greater yields and specific capacities than would otherwise be possible (cit. ibid). Proper interpretation of strata as drilling of boreholes proceeds is also important since it may allow savings to be made with regard to aspects of the design such as casing length, screen size, screen length and gravel pack/geotextile sizing.

Air flush mechanised drilling methods (with the use of foams where appropriate) allow the yield and strata to be more easily assessed as drilling proceeds than is possible when mud drilling is employed and the identification of narrower aquifers in sedimentary strata is therefore made easier. Down the hole geophysical logging can sometimes be cost effective in giving guidance for the accurate location of screens opposite to thin high yielding aquifers and boreholes may then not have to be as deep as they would have been if such methods were not employed (cit. ibid).

Where a programme is to be based on communities participating in the construction of a hand dug or hand augered well there is another factor which needs to be considered. If in such a case an excavation does not find water then the whole programme may be affected because other communities will not want to take the risk of labouring in vain. Proper hydrological investigations can avoid such an occurrence and reduce costs.

When considering the suitability of water bearing strata for exploitation it is important that the small yields that are generally required for handpump extraction are recognised. Yields of 0.2 - 0.3 litres/sec are usually enough for handpumps which means that many areas not generally regarded as potential groundwater sources are in fact suitable for this method of extraction (Arlosoroff et. al. 1987). However allowance will need to be made in low yielding aquifers for the likely large drawdown which will arise in the borehole during pumping. An aquifer with a specific yield of only 0.05 l/sec/m

can meet the demands of one handpump if the drawdown reaches 5m.

Unlike small diameter boreholes, hand dug wells are able to store appreciable quantities of water and this often means that even lower average yields than that mentioned above can meet the water needs of a community because the aquifer can be yielding water to storage throughout the day and night. For example a community of 200 people requiring 30 litres each per day can probably be satisfied by an average yield of only 0.7 litres/sec if about 4 - 5m³ of storage is provided (5m³ is equivalent to 3.8m depth in a 1.3m diameter well). Where large numbers of people are likely to use a hand dug well in a slow yielding strata it can be dug with a larger diameter to improve the area seepage face in the aquifer and to increase the volume of storage per unit depth. Another very effective method of increasing the yield, but one which involves the use of mechanical plant, is to bore horizontal holes radially through the walls of the well and into the aquifer (Figure 5.4.1.4). The British Geological Survey has been involved in the development of this technology which needs a well of at least 2 metres internal diameter. The equipment has been field tested in Sri Lanka and Zimbabwe in alluvium and weathered rock where dramatic improvements in yield resulted [Wright & Herbert (1985), Herbert (1990), Herbert & Rastall (1991)].

Whatever method for reaching and abstracting groundwater is used it needs to be able to conveniently provide sufficient quantities of water which can be collected at a rate which makes use of the facilities more attractive than the use of any other local sources of water. One approach is for the hydrogeologist to start his/her investigations from the position chosen by the users and then to work outwards from this point to find the nearest site capable of yielding sufficient water.

Groundwater near to existing surface water sources is considered in Section 5.4 where surface water infiltration systems are examined.

In Section 2 possible problems relating to groundwater quality, corrosive groundwaters and the rejection of potable groundwater by some communities were mentioned and these will also need investigation. It should be noted

that groundwater held in fractured rocks, unlike that in fine grained aquifers does not benefit from natural filtration as it passes through the fractures, and the risk of contamination are therefore greater. However, the groundwater may have reached the fractures through superficial deposits. Other factors which need considering when promoting groundwater as a source are seasonal or annual movements of the water table and competing demands from nearby powered pumps.

3.3 Reaching The Groundwater

3.3.1 Reaching groundwater using large diameter excavations

Hand dug wells:

Traditional use

Some communities have traditionally dug holes down to the groundwater table to extract water for domestic use. Where the excavation is in a river bank the well not only exploits groundwater approaching the river but, under the right conditions, it can also collect infiltrating surface water from the river. Where seasonal rivers occur excavations in the river bed during the dry season are often used by local people to collect water flowing below the bed. These river bank wells and river bed wells are considered further in Section 5.4.

Usually traditional wells are of poor design and as a result the water is often polluted with faecal pathogens and in Guinea worm endemic areas with infected copepods. It is usually possible to improve a traditional unprotected well to exclude much of the contamination by providing an improved lining and a parapet wall and apron slab. Further improvements can result from the provision of a rope and windlass, or the use of only one dedicated bucket which is never placed on the ground by users. The cost of a mass produced windlass used in Zimbabwe, as illustrated in Figure 3.3.1.1 is about \$13. These systems have been provided free with three bags of cement as an incentive to users to protect adequately their household wells involving a total subsidy of between \$60 to \$80 (Morgan & Chimbunde, 1991). Still further improvements are possible if the well is covered and fitted with a more hygienic water drawing device (Figure 3.3.1.2) as discussed below when considering new wells.

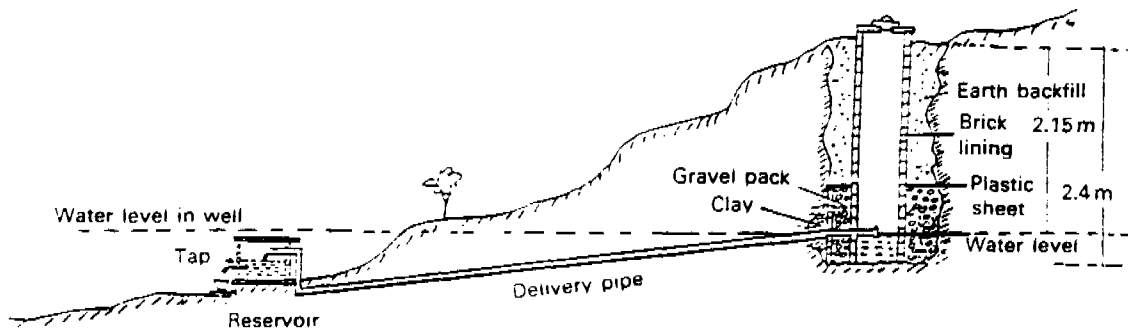
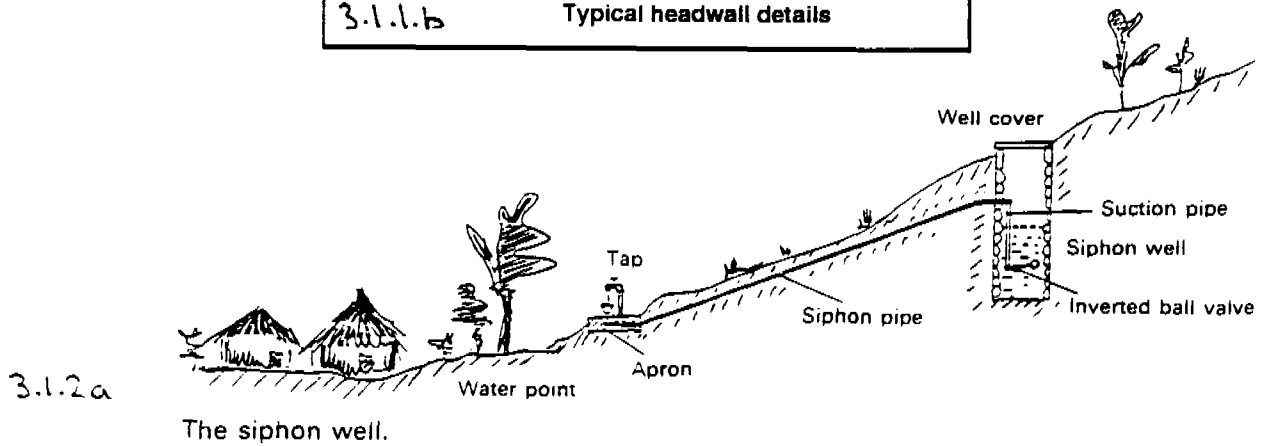
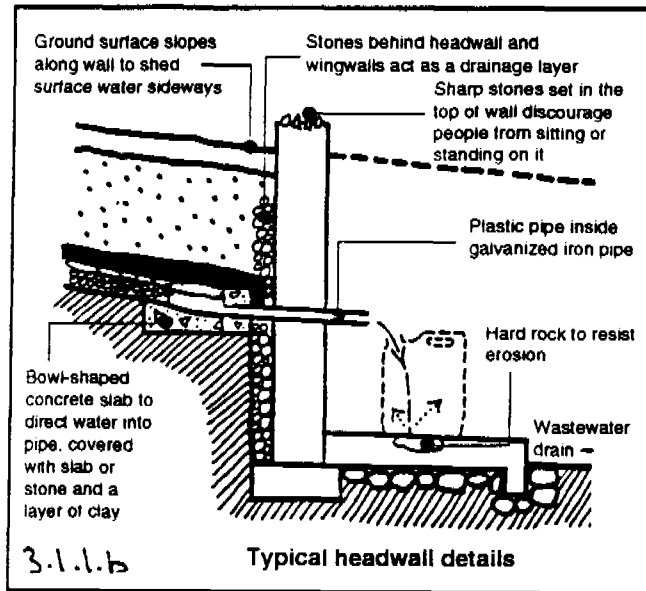
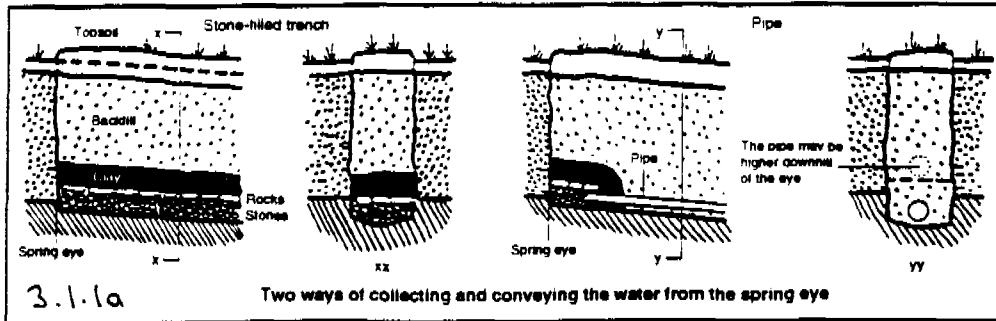

Improved construction

As discussed in Section 2 pure groundwater can often become polluted and can easily become a source of copepods infected with Guinea worm larvae because the design of the collection point is poor. There are a number of good references to those design features of hand dug wells which are necessary to reduce the risks of contamination by users, spilt water or surface water [Watt & Wood (1976), DHV (1979), DHV(1985)] and they will not be repeated here. The common methods of construction and lining are also described in these two references together with the necessary safety precautions. Different methods of construction are appropriate for different strata.

In firm self-supporting strata common practice is to excavate in the dry season until groundwater entry causes difficulty and then, where necessary, to construct in situ lining starting at the bottom of the excavation. Deepening into the water table then continues by excavating inside a sinking caisson until the well has penetrated sufficiently far into the aquifer. During this caissoning stage a pump is used to dewater the excavation.

In strata which are not self supporting it is possible to line the well in short sections as excavation proceeds from the surface until the groundwater causes problems. Then where necessary proceeding by caissoning. Alternatively virtually all of the well can be excavated from inside a sinking caisson. Both methods can also be used in firm strata.

Permanent lining and caissoning is often constructed from mass or reinforced concrete or hard burnt bricks. Winter (1987) gives details of the use of precast ferrocement linings. All these linings are relatively costly and their construction is often time consuming. One time saving idea used for the production of precast cement mortar rings in Zimbabwe is to compact the mortar between slightly tapering shutters. The height of these rings is only 300mm and they are lightly reinforced with wire. The shutters can be removed almost immediately so that about 20 rings can be cast in one day using the same shutter.

For the 'backfilled well' design (see below) no costly permanent large diameter lining is needed but instead a small pipe casing is installed (Figure 3.3.1.3). Another cost saving is possible if permanent lining is only used in the section of the well in the aquifer and this lining is then capped with a strong concrete cover slab from which only a smaller diameter casing rises to the surface (Figure 3.3.1.4). One disadvantage of both these methods is that a reliable pump must be available for withdrawing the water unless the pipe is at least of sufficient diameter to take a bucket (or a 'Blair' bucket pump is used). Another disadvantage is that, unlike conventional wells, these backfilled wells can not be easily deepened should the groundwater level ever drop below the bottom of the well.

Modified Chicago Method of temporary support

One interesting hand dug well construction method which does not use any large diameter permanent lining is the 'Modified Chicago Method' of providing temporary support to the excavation. This method is promoted by Consallen, a British manufacturer of an open-top cylinder handpump. It reports that the method has been used in Liberia and recently more extensively in Busoga, Uganda where to date 250 wells have been constructed with 90 being completed last year (Consallen, 1992).

The temporary support system used with the Modified Chicago Method consists of vertical timbers (about 150mm x 50mm x 4200mm) positioned around the circumference of the excavation and held against the excavated face by wooden wedges driven between the inside face of the boards and number of circular steel wailings (Figure 3.3.1.5). The wailings which are each in the form of a 1.22 metre diameter ring of welded steel channel section (about 100mm x 50mm) are spaced vertically at about 1 metre centres down the excavation to form compression rings against which the wedges act. Each wailing comes in two halves which can be lowered down the well and be bolted together and positioned against the boards at the bottom of the excavation. The spacing of the boards around the circumference of the excavation can be chosen to suit the ground conditions.

Excavation near to the circumference of the well proceeds under the end of each board in turn. Excavation periodically stops and the wedges

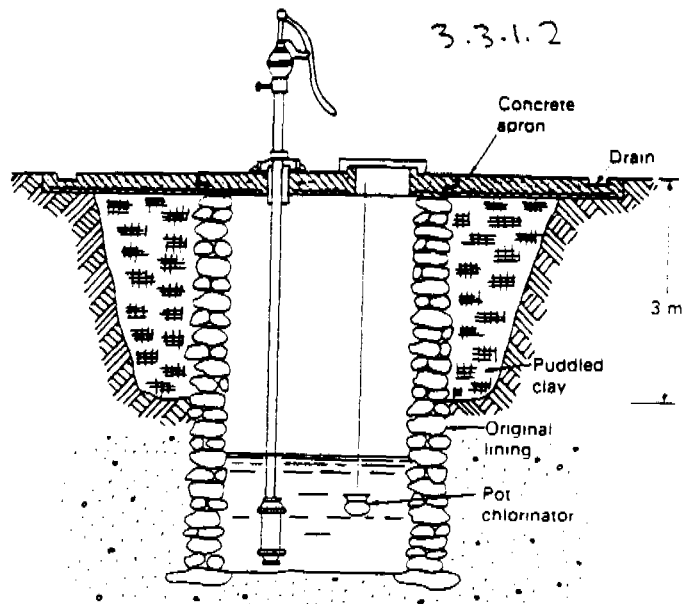
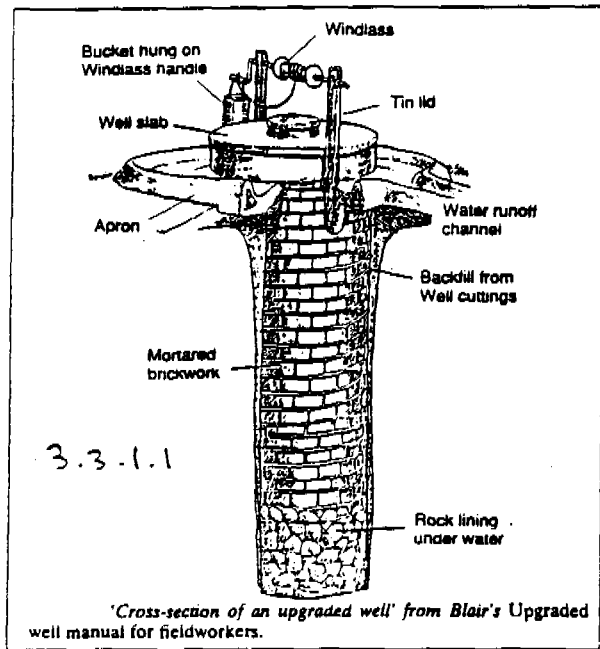

Improving an existing well by adding a hand pump, a cover slab, an apron and drain, and a puddled clay barrier against seepage of surface water

Source: After Wagner and Lanoix (1959)

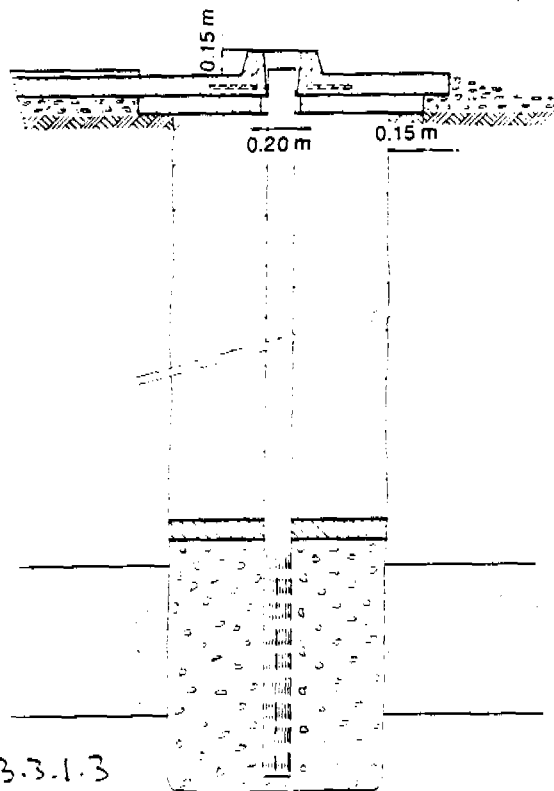

Backfill well

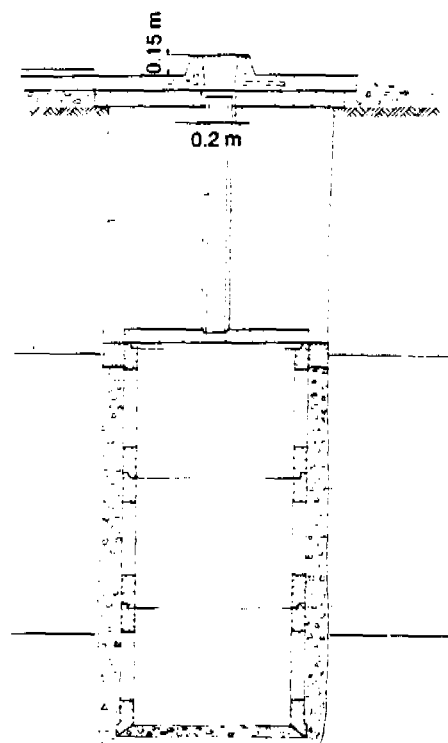

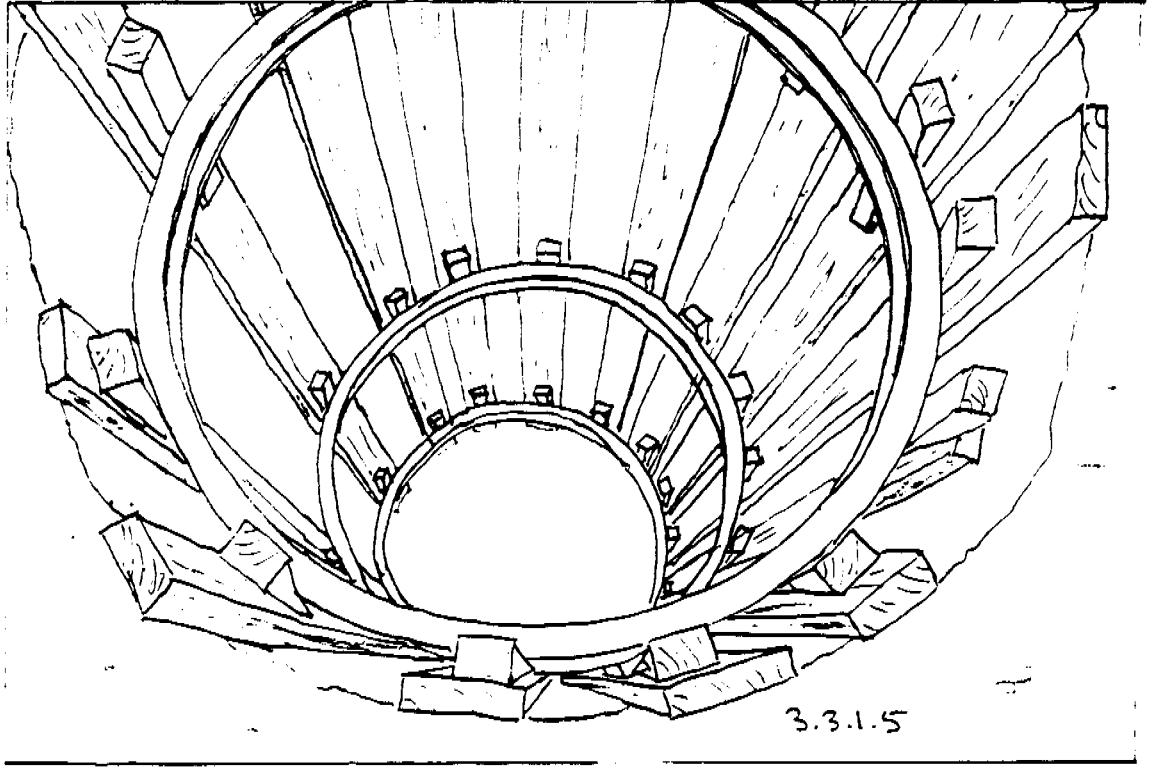

holding individual vertical boards for that particular sector of the circumference are loosened so that each board can be moved down so that its end again touches the bottom of the excavation. Once a full length of board has been installed in the well additional boards can be fed behind the rings from the top to follow each descending board. As excavation proceeds additional wailing rings and wedges are added at the bottom of the excavation to support the boards which have been moved down.

The advantages of the Modified Chicago Method cited by Consallen include:-

- * It employs very little capital equipment.
- * Local manufacture of the equipment is possible.
- * The equipment can be carried from site to site as head loads.
- * In all types of soil conditions the workers in the well are always fully protected.
- * Excavation work can safely proceed below groundwater level in dewatered excavations
- * It maximises the contribution of untrained village workers allowing trained personnel to supervise the construction of several wells simultaneously (e.g. one technician can supervise 6 wells).
- * The water yield can be tested before completing the well.
- * **There is no loss of materials in the event that the hole has to be abandoned.**

Backfilled (Cased) Wells

If temporary supports are used to support the sides of an excavated well, once the excavation has sufficiently penetrated the aquifer it is feasible to install just a 110mm diameter uPVC casing pipe from the surface, then to backfill the well and to install a handpump in the casing pipe. The section of the excavation in the aquifer can be permanently lined with large diameter rings (Figure 3.3.1.4). An alternative is to use a slotted uPVC pipe surrounded with a geotextile or gravel pack, which in turn is surrounded with free draining material which fills the remaining space to the edge of the excavation (Figure 3.3.1.3). Both designs can considerably reduce the cost of constructing a hand dug well but the small diameter of the pipe means that a reliable sustainable handpump has to be purchased because the usual bucket and rope system cannot be used to draw out the

water (other than as with the Blair bucket pump (Figure 3.3.3.6).

Consallen (1992) reports that the capital cost of the equipment needed to excavate a typical 15m well excavated using the Modified Chicago Method, including the jet ejector pump used for dewatering is about £1000. Since these materials are all reused the costs can be spread over a large number of wells. The cost of four sets of equipment allowing a technician to supervise work on four sites at one time is only £2000-£3000 if the pump, which is only needed for part of the time, is shared between the four sites. The UK based NGO which is supervising the programme in Busoga has calculated that, where free local labour is used for excavation, the total cost of constructing each well and equipping it with a handpump is about £1200 including all UK and field staff overheads (Consallen, 1992).

Advantages of hand dug wells

There are significant advantages of hand dug wells worth noting.

They can be used in low yielding aquifers and where appropriate can be used with horizontal boring to give considerably improved yields.

It is possible to remove or break up large stones or rocks which would be troublesome in a hand augered hole.

If the aquifer is a fractured rock then once this level has been reached, if pick axes are not suitable to make progress, excavation may be able to proceed using a hand held air compressor driven tool. If a cased well is to be produced a simplified down the hole (DTH) hammer drill can be operated to make a borehole into the rock to save the expense of a large diameter excavation. In certain situations carefully controlled use of explosives down the well may be appropriate to allow the continued construction of a large diameter well in harder rock. A Zimbabwe method, using hand chiselled charge holes, is described in non-technical language in a publication for fieldworkers written by Laver (1987).

In a hand dug well programme in the Houet and Kenedougou provinces of south-west Burkina Faso 53 wells with an average depth of 25

metres were dug in 1984-85 with a unit cost of US\$7,472 (excluding a handpump but including US\$3388 administrative costs). It used pumps, compressors, jack hammers and sometimes dynamite to excavate into a weathered zone and the underlying fractured granites and schists excavating at least 3 metres below the dry season groundwater level. On average, one team took two months to complete each well with the aid of the community. (Roark et al. ,1986). Another project which operates in northern Ghana, and which also uses compressors and jack hammers to construct draw wells up to 12m deep to penetrate decomposed rock has 'all in' unit costs of about £1800 (Water Aid, 1992).

If the strata at the base of the excavation is fine grained it is possible to probe ahead of the excavation using simple water jetting equipment to check what other strata is to be encountered and to confirm the groundwater level. If a cased well is to be produced the 110mm screen can be directly installed in the jetted hole. This is particularly useful where running sand is encountered since such strata makes excavation difficult.

Hand dug wells make maximum use of local materials and labour and the community can take a major role in their construction leading to a greater sense of ownership. Their participation in its construction demonstrates their strong desire for an improved water supply which is important if the facilities are to be properly cared for. Communities where such a desire is not present are less likely to attempt a hand dug well project giving an early indication of the need for additional health education and mobilisation without which any water supply project in that community would be likely to fail.

Where the well is left open as a draw well simple bucket and rope systems can be used for drawing the water, and particularly with the larger diameter wells more than one person is able to draw water at the same time.

3.3.2 Reaching groundwater using small diameter excavations

Various techniques of boring small diameter holes are detailed below and some specific advantages or disadvantages are discussed in

each section. There are however some general advantages and disadvantages which apply to all small diameter excavations:-

Advantages:

- Greater depths are usually possible than with hand dug wells.
- Progress is usually fast compared to hand dug wells.
- With proper completion it is relatively easy to prevent the groundwater being polluted before collection.
- The design of some 'open top cylinder' handpumps means that in some situations no borehole casing is needed because the rising main never needs to be extracted.

Disadvantages:

- The level of technical support is usually higher than for hand dug wells.
- A handpump is always needed (unless a 'bucket pump' is used) and this can lead to problems of sustainability.
- Where borehole casing, screens, pipes, handpumps etc. are not manufactured in the country there is a need for foreign exchange to import them. There is not usually a need to import materials with hand dug draw wells.
- Some strata is unsuitable for boreholes because in slow yielding aquifers a large volume for water storage in the well is needed. This can only be provided by large diameter wells, or the large diameter backfilled wells already discussed.

Machine drilled wells

There are a wide variety of drilling rigs promoted by various manufacturers to produce small diameter holes in the ground suitable for exploiting groundwater and this report is not a suitable place to describe all the methods and the particular strata and other situations in which each is appropriate [Annex 2 of Hofkes et. al. (1983) is recommended as introductory reading]. The term boreholes is used to describe such holes in this report. The term tubewell is also in common usage but this is a category taken to also include wellpoints which may be driven or jetted into a strata with no boring actually taking place.

There is no ideal all-purpose drilling rig or system of drilling but there are some important

factors which should always be considered when choosing a rig for use in a developing country in order to achieve cost effectiveness.

What degree of sophistication can be supported in the field?

For example, although a powerful rotary rig will usually drill boreholes much faster than a simple cable-tool (percussion) rig, if when the former breaks down it can not be repaired for a long time overall progress will be hampered. The usual high running and maintenance costs and the high level of technical support needed for the larger rotary rigs may also mitigate against their use. Because the capital cost of a powerful rotary rig is very high it may be possible to purchase a number of simpler rotary or percussion rigs which despite a slower individual rate of output could together give acceptable overall progress in providing boreholes.

What size of rig is appropriate for the ground conditions?

If the rig chosen is larger than what is really needed for the strata and type of borehole being constructed then the unit costs of the holes are likely to be higher than necessary. It should also be noted that the access requirements for a large rig will also restrict the places where boreholes can be drilled because the size and weight of the rig may mean it is unable to reach many sites, especially during a wet season. Smaller, more mobile, rigs on the other hand may be able to reach remote areas away from the main roads near to which the large rigs usually operate.

In Sudan, the convergence of resources (leading to reduction of overheads and costs of logistical support), production incentives (leading to increased output) and community involvement (allowing the government to optimize capital resources and minimise recurrent cost disbursements) has brought about substantial reduction in unit costs. The cost of a handpump equipped borehole in Sudan was US\$2800 in 1989, less than one third of the cost of the same provision in 1985 (WES 1992)

In UNICEF-assisted projects in Nigeria a combination of lighter and cheaper drilling rigs and support vehicles, effective use of state of the art geophysical equipment and methods for

borehole location, import substitution of borehole construction materials, a reduction in the ratio of expatriate to Nigerian staff and the depreciation of the Naira led to the unit cost of a handpump equipped borehole dropping from US\$28,000 in 1981 to US\$3,700 in 1990 (de Rooy 1992). The average annual exchange rate during this period fell considerably from about US\$1.6 to US\$0.1 per Naira (cit. ibid) but the reduction in unit borehole costs is nonetheless very commendable and other projects should consider making similar changes to their drilling programmes to reduce costs. By 1990 the cost of boreholes in UNICEF-assisted projects in Nigeria ranged from an average of US\$85 to US\$115 per metre drilled which compared favourably with those in Malawi and Guinea (cit. ibid quoting Beale, 1990).

Other recent unit costs per handpump equipped borehole (drilled about 40m deep), based on programmes of over 65 boreholes were obtained for Zimbabwe (@ £4000) and Angola (@ £5000). From the same source (Jackson, 1992) other probably less reliable unit costs were quoted as follows:- Senegal (@ £12,000), Namibia (@ £5,500), South Africa (@ £4,000) and Mozambique (@ £2,700).

Chauvin et. al. (1992) quote an average cost of US\$14,858 per completed borehole in a project which completed 298 installations in the north of Zou province in Benin. This figure includes the cost of:- unproductive wells (there was a 79% success rate), installation of a handpump (India Mark II), training of handpump technicians, salaries and benefits of all personnel and the cost of all equipment and supplies. For the purposes of comparison Chauvin quotes a figure of US\$9,700 per completed borehole reported in 1985 for the Togo Rural Water Supply and Sanitation project.

Roark et al. (1986) give an average cost of US\$16,116 (including US\$4,405 administration costs) for a programme of 15 new drilled wells and 6 rehabilitated (deepened) boreholes drilled during 1984 and 1985 towards the end of a 7 year programme in south-western Burkina Faso. This includes the cost of all equipment consumables, personnel and the operational and administrative costs. It is also believed to include the cost of 3 unproductive wells but this

is not clearly stated. The average depth of the wells which were drilled into both sedimentary and crystalline rock was 60m. Roark points out that if the cost of external technical support is subtracted, as would be the case if the work was performed entirely by Burkinabe technicians, the cost would reduce by 11%. He notes also the difficulties experienced maintaining the drilling rig for which in 1985-86 alone the repair costs reached about US\$20,000. In a number of years during the project, breakdowns led to long periods when the rig was unavailable. Additional constraints on the rate of borehole completion were caused by rain which prevented work during 2 months of each year.

This wide range of borehole costs between countries shows that caution is needed if comparing or making use of such unit costs for new projects. For example the basis on which each project calculates its unit costs (such as the amortisation of plant costs) and the field conditions in which each operates can be very different. The density of boreholes being drilled in a project area also has a major effect on the rate of completion and therefore the percentage of overhead costs charged to each hole. In-country experience of borehole drilling is the obvious the best starting point for cost estimates for any proposed projects but even within one country, operating conditions may vary considerably.

Figure 3.3.2.1 shows a useful map produced by UNICEF in September 1991 to indicate the type of drill rigs most appropriate to the hydrogeology of different areas of Nigeria (Donaldson, 1992). Note that it includes areas where manually operated rigs can be used. Presumably manually operated rigs are also appropriate in localised zones within other areas of the country, but these cannot be shown on such a small plan. For example Figure 3.3.2.2 shows areas where the wash-boring of tubewells is possible. **The production of similar maps for other countries would provide a very useful project planning tool.**

The use of larger numbers of simple low cost powered rigs instead of large sophisticated ones is a worthwhile area for further investigation into cost effectiveness. Simpler designs of rigs are probably available from a number of sources

but an example from just one manufacturer will suffice to show their potential cost effectiveness. These are purely examples about which data was readily available (Eureka, 1992) and the authors are not in a position to recommend them above any other types that may be available from other manufacturers.

Eureka UK Ltd. produce two simple low cost top drive rotary rigs. Their recently produced 'Port-a-Rig', costing around £8,000, is highly mobile since it can be carried in the back of a standard pick-up. In order to make things as simple as possible a manually operated chain and sprocket system is used for lifting the drill string and the rotary head is shaft driven, avoiding the need for any hydraulics. Its water/mud tank which rests on the ground provides stability, and using water or mud circulation the rig can drill boreholes of up to 200mm diameter down to about 30m in unconsolidated strata. Use of £10,000 worth of ancillary equipment, consisting of a down the hole (DTH) hammer and a small towable compressor, allows holes of up to 100mm diameter to be drilled in hard rock.

Eureka's trailer mounted rig has similar features to the 'Port-a-Rig' but with a higher horsepower motor and a stronger lifting winch which allow boring to proceed to depths of 60m. The trailer body acts as a water/mud circulation tank. The mast allows the easy handling of 6 metre lengths of casing. The basic unit with a pump for direct circulation rotary drilling costs around £22,000 with an extra £10,000 for the DTH hammer and compressor.

One other important factor which can have a dramatic effect on the rate of borehole completion, although not related to the technology, should be considered in every project. This is the paying of bonuses to drilling teams. Mc Pherson et al. (1989) report that in Sudan a bonus system shared between managers and field crews on a pro-rata basis led to a doubling or even tripling of output in some drilling programmes reducing costs dramatically. With such a system problems of negligence in care of vehicles and a general lowering of quality due to poor workmanship need to be decisively addressed. This can be done through close supervision, quality control

**Drill Rig Zonation Map
Village Water Supply**

3.3.2.1

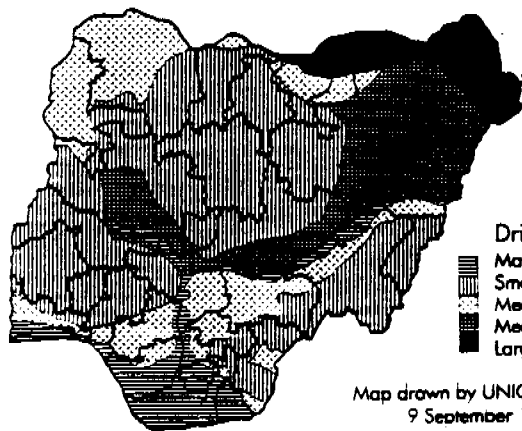

Drill Rig Type.
 Manually Operated
 Small
 Medium
 Medium Large
 Large

Map drawn by UNICEF Nigeria
9 September 1991

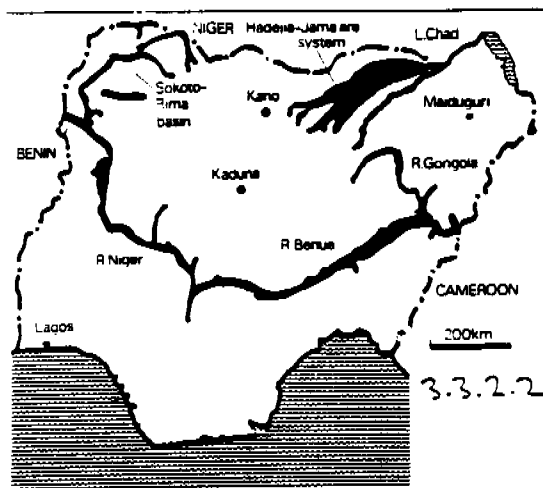

3.3.2.2

Fadamas of the major north Nigeria rivers

and across the board payment cuts where standards are not maintained (cit.ibid).

Dodge et al. (1986) report similar dramatic improvements in rates of borehole completion and consequent reduction in borehole costs in a UNICEF supported programme in Uganda.

Hand drilled boreholes

In a number of types of geological strata it is feasible to drill small diameter boreholes manually. The lighter hand boring equipment is suitable for drilling small diameter holes (up to 100mm diameter) which can be used to assist in prospecting for water and in locating hand dug wells or larger diameter hand drilled boreholes. In a small range of strata 100mm diameter boreholes can be equipped with handpumps but usually a larger diameter is needed and boreholes up to 300mm diameter are possible with the heavy duty rigs. Such sizes allow a reasonable thickness of gravel pack to be installed around the borehole screen. The use of a gravel pack is not usually possible with the smaller diameter holes but sometimes geotextile filters or fine slotted wellpoints can be used instead. In some strata the use of a gravel pack, fine screen or geotextile is particularly important in preventing abrasive sand entering the borehole and damaging the handpump. The larger perimeter of the gravel packed holes makes them more suitable for slower yielding aquifers.

A very comprehensive guide to all aspects of hand drilled wells, covering location of suitable sites, design, to maintenance of pumps and wells is given by Blankwaardt (1984). This reference, based on experience in a large hand drilled wells project in Tanzania, is strongly recommended as a source of information concerning the various techniques. Tanzanian experience has been that the construction time for a hand dug ring well is 3 - 7 weeks, depending on depth and soil conditions, whereas a hand drilled tubewell is normally constructed in only 3 - 5 days (cit.ibid.). Other useful information is given in publications by DHV (1979 & 1985).

Figure 3.3.2.3 shows a graph of cost per metre versus depth for ring wells and tubewells in a project in Tanzania (DHV 1985). A steeper gradient to the graph beyond a depth of 6-7m can be observed. This is due to the fact that

suction pumps can no longer be used for dewatering can no longer be used and more expensive deepwell and due to the cost of labour and transport of rings which increases rapidly with depth (cit.ibid). So for an average depth of 8 - 10m a ring well was found to be 2 to 2.5 times as expensive as a tubewell (Blankwaardt, 1984).

The 'Vonder Rig' a hand auger rig developed in Zimbabwe where it is now manufactured by V & M Engineering (Pvt.)Ltd. who export them throughout the world. The rig has been used extensively in Zimbabwe and about 250 were manufactured and sold between 1983 and 1989. In March 1992 the typical cost for a complete rig air freighted into Ghana was US\$ 2,500 (V & W Engineering, 1992). Similar rigs are also manufactured in Kenya.

The Vonder Rig (Figure 3.3.2.4) is a lighter rig than that used by Blankwaardt but it can be used to hand drill 170mm diameter holes through soils and decomposing rocks. It takes about 30 minutes to unload and assemble on site and the initial drilling rate is about 3m/hr. After 2 - 3m depth the drilling rate reduces to 1.5m/hr in soft formations and 0.5 - 1.0m/hr in harder formations. Hence a 6m hole can typically be drilled in approximately 5 hours and a 12m hole in 1.5 - 2 days. Several types of auger or drilling bit are available, including a hole saw which is designed for cutting through soft decomposing rock formations. Usually the augering takes place in an uncased hole and a casing is added after completion but there is an adaptation which allows temporary casing to be installed as drilling proceeds. (Morgan 1990)

Recent experience of hand drilled boreholes in Niger is reported by Naugle (1992). A set of augers can be locally manufactured in Niger by a skilled welder for about US\$200 and some sets have already been successfully used for over 50 boreholes with only minor repairs being necessary. The cost of the wells which are used for irrigation and hence do not have apron slabs is essentially the cost of the 150mm diameter casing (which in Niger costs about US\$15/m), and labour (one days wages for two drillers or about US\$15). The screen necessary to exclude sand consists of a section of slotted casing sheathed in geotextile filter. A well extending 4 - 5m below the water table with a depth of 10 -

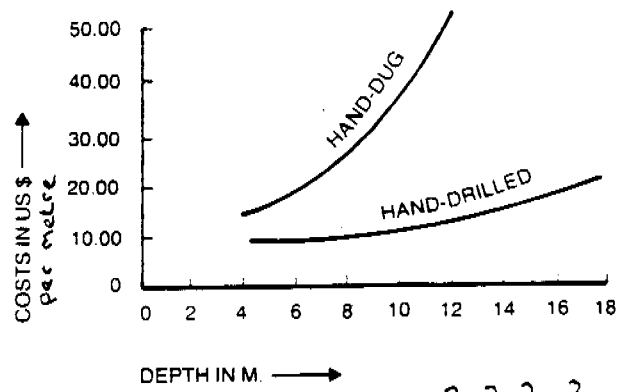

3.3.2.3

Costs of shallow wells

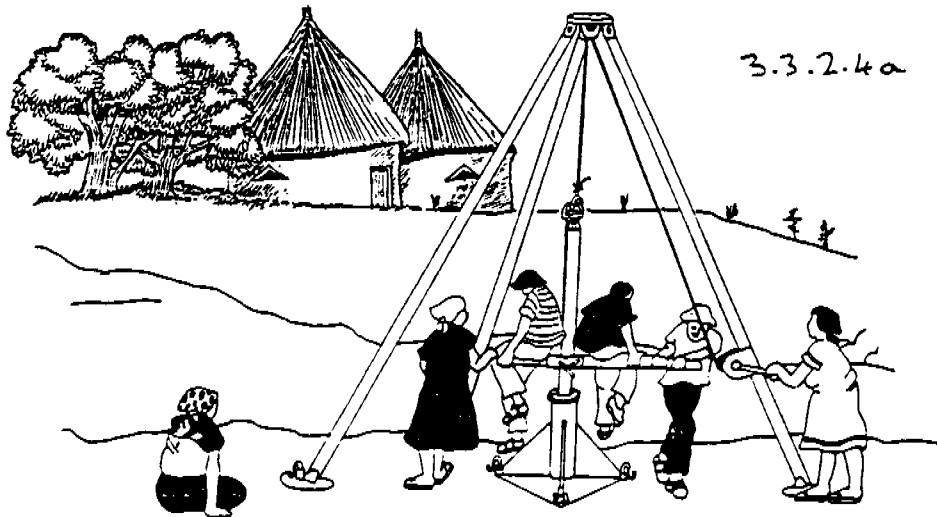

3.3.2.4a

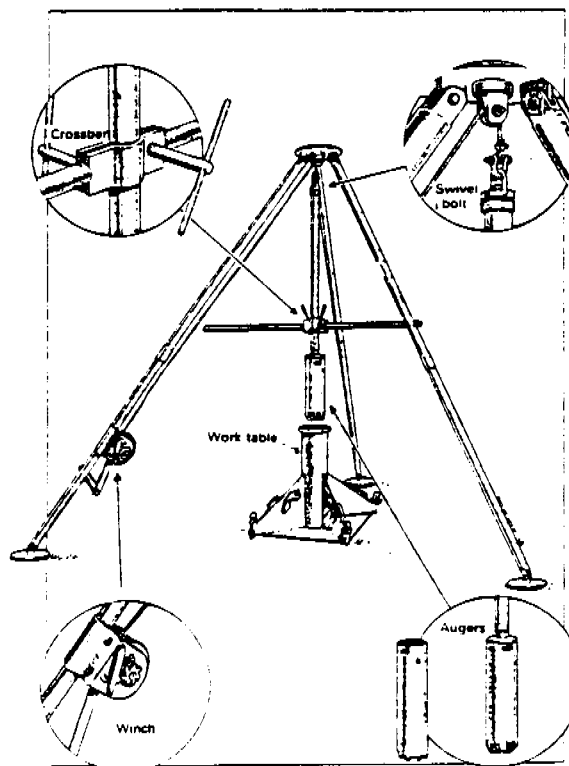

3.3.2.4b

Working parts of the Vonder Rig. A hand-operated drilling rig.

12m can be installed in less than 5 hours in sandy soils. Flow rates of up to 9m³ per hour were found to be possible when using motorised pumping from a 7m deep well. (Naugle, 1992).

There are several advantages to the use of hand drilled wells.

There is a greater cost effectiveness than hand dug wells and the speed of completion is greater. The technology is well suited to full village level operation. Villagers can easily construct their own boreholes. The amounts of work and local materials required are less than what is needed for a hand dug well and progress is faster.

The smaller rigs, like the Vonder, are very mobile since they can be easily carried to the site by the community. It should be noted that where concrete is being used to line a hand dug well a vehicle is often required to carry precast rings to the site or to carry the considerable amounts of sand, aggregate and cement needed for the on-site production of rings or in situ lining.

Operations can proceed throughout the whole year and no dewatering pump is needed. This is because the small diameter holes are relatively stable, or can be cased during drilling, to allow boring to proceed in strata well below high groundwater levels usually without any dewatering. Such conditions can pose major problems with hand dug well programmes which are sometimes only possible during a period at the end of the dry season when lower groundwater levels allow the dewatering and deeper excavations which is necessary for sufficient penetration of the aquifer.

It is more feasible to reach some deeper, more reliable aquifers than when using hand dug well technology.

However there are also some disadvantages. In some strata the smaller diameter holes (such as the 170mm hole produced with the Vonder rig) will be unable to yield enough water for a community. (However the construction of a second borehole to double the total amount of water available, may still be cheaper than the alternative of a hand dug well.)

The auger bits cannot penetrate hard rock, and problems are usually experienced with very coarse gravels or layers of pebbles.

Wash-bored (Jetted) Tubewells

Wash-boring, also known as well jetting, is a technique used to construct tubewells in strata consisting of fine or medium sized sand. It usually uses low pressure water (or sometimes mud) which is pumped down to the bottom end of a vertical pipe pushed into the ground so that the fluid washes the sand particles at the bottom of the hole into suspension. The flow of fluid then carries the soil up the annulus between the jetting pipe and the wall of the hole to the surface. The pipe is raised and dropped and rotated during the pumping operations to improve the rate of progress. Various attachments can be added to the end of the pipe such as cutting teeth or jet orifices to suit the soil conditions. If water is in short supply recirculation pits can be used as in direct circulation rotary drilling but the pump then needs to be tolerant to the passage of some solids. Mud is circulated instead of water when drilling in ground where there would be high water losses from the walls of the hole. If affordable, biodegradable polymer muds are usually preferable to bentonite since the former do not permanently block the pores between the sand particles and hence do not adversely affect the yield of the borehole. Figure 3.3.2.5 shows the major components of a simple jetting rig.

The technique has been in use around the world for some time in particular by civil engineering contractors for installing 'wellpoints' for dewatering around excavations.

The use of wash-boring in developing countries has been under research for a number of years at the National Institute of Agricultural Engineering (NIAE) at Silsoe, Bedfordshire, UK. [Mentianu (1982), Carter (1985) and Cornish (1987)]. Two different systems have been promoted. The first NIAE method uses a 100mm steel pipe which produces a hole of about 150mm diameter. When the equipment is hand held this has a practical depth limit of about 12m (Carter, 1985) beyond which the weight of the pipes become excessive. The large diameter of the jetting pipe allows the insertion of a permanent casing into the pipe before the pipe is withdrawn. Cheap 80mm outside diameter (72mm inside diameter) flexible

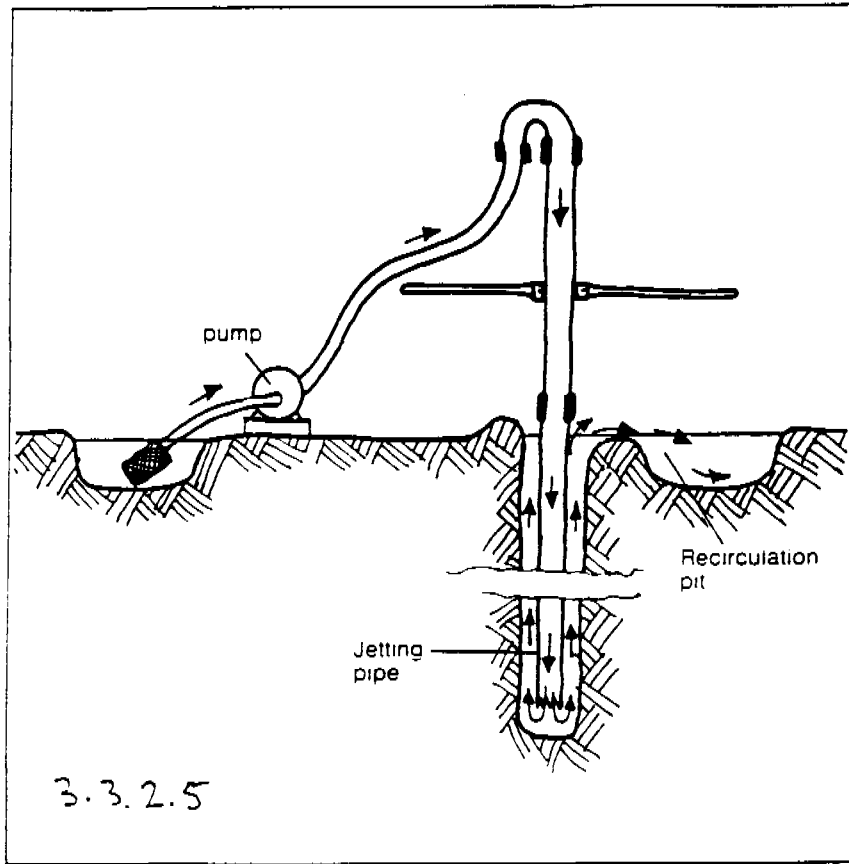

Major components of a simple jetting rig

Figure 1: The drill pipe is raised, and its top end is sealed. Water flows down to the base of the well, loosening soil there.

Figure 2: The drill pipe is forced down, deepening the well. The top of the drill pipe is open, allowing soil and water to spill out.

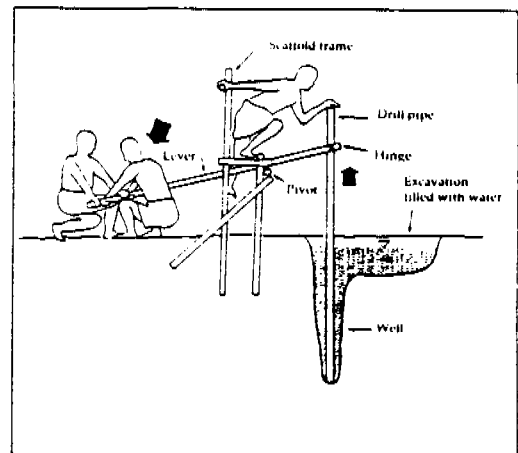
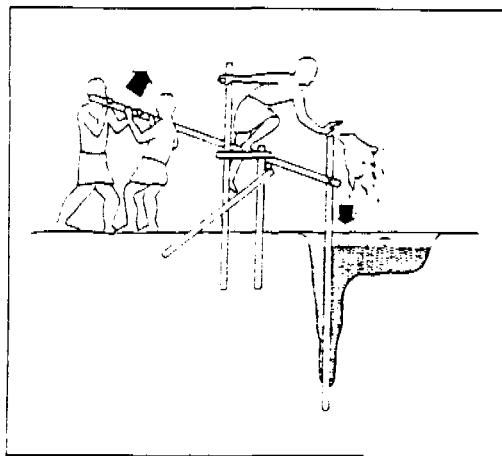

3.3.2.6

perforated plastic field drainage pipe transported as a coil has been used successfully in some wash bores as a screen. It is sheathed in 1000 gauge 'layflat' polythene tubing or with a rigid non-perforated tube to form an impermeable casing where needed, such as for the top 3m of the hole to prevent the easy entrance of pollutants. The annulus between the aquifer and the screen is filled with coarse sand or fine gravel pack.

The speed of jetting through coarse sand can be as fast as 1m/minute but it is unacceptably slow in heavy clays being only about 100mm/minute. Under reasonably favourable conditions 6m deep wells have been jetted using 2.7m³ of water. A team of four men is recommended for this technique who could jet between two and four wells per day (Metianu, 1982).

The 1982 UK costs quoted by Metianu were:- the local fabrication of the jetting equipment (£100 materials and £400 labour); the purchase of a 50mm, 5kw, centrifugal engine (£350); 100m of layflat pump hose with quick release coupling (£200). So the total cost of reusable equipment suitable for a 12m deep wash bore was £1050. The cost of the casing materials for the same depth came to only £5.

The second NIAE method uses a 50mm diameter jetting pipe of light gauge steel. This allows the hand operation of the equipment down to about 30m depth, at which stage the weight of the drilling column becomes excessive (Carter, 1985). The small diameter jetting pipe prevents the internal installation of a permanent casing or screen as was possible in method 1. Where necessary a temporary or permanent casing (100 -125mm diameter) can be pushed into the jetted hole as work proceeds, so that it follows closely after the jetting head. Where a temporary casing is used it allows a smaller diameter permanent screen and casing to be installed inside it before the temporary casing is removed. Coarse sand or gravel pack can be carefully poured down the annulus between the temporary and permanent casing as the former is slowly withdrawn. In self supporting strata no casing may be needed during jetting and a permanent casing can installed after the jetting pipes are removed from the wash bore.

Cornish (1987) reporting on the use of the second method in Mexico gives a materials cost of US\$65 for a complete 9m deep lined jetted well with suction handpump (the latter costing only US\$34). Making allowance for plant running, maintenance and depreciation costs the figure rises to about US\$80 per installation.

Carter (1985) reports extensive use of jetting in northern Nigeria where the flood plains, or *fadamas*, of the seasonal rivers are often several kilometres wide (Figure 3.3.2.2). For the greater part of the year the rivers are confined to relatively narrow channels but they experience seasonal flooding and hence the recharge of shallow alluvial aquifers. A large number of jetted wells, usually 8-10m deep, have been installed in such areas mainly for irrigation water which due to the high water table can be extracted by powered suction pump.

SWS (1992) promotes a different jetting system (SWS Well-Jetting Technique) which directly jets a wellscreen into the ground. The "self jetting" modification to the screens uses two simple 'valves' which allows the full force of the jet of water to exit from its lower end, rather than through the screen, to enable it to be jetted through the soil and into the aquifer. When jetting is completed the valves return to a position which admits only water from the fine sides of the screen and none from the un-screened jetting end. This wellscreen currently costs £75 in the U.K. Between 1983 and 1989 more than 3,000 wells were installed in Kano State, Nigeria using this 'SWS well-jetting technique'. Commonly these were no more than 10m deep although where necessary, it is possible to penetrate through 30m of silty materials to reach a sandy aquifer. Most of the jetted wells were for irrigation water, with typical yields of up to 5 l/sec with a 3.5 HP 2" inlet diameter powered pump. (SWS 1992)

SWS have also promoted the use of a second jetting pipe used alongside a pipe with a standard Johnson wedge wire screen which is lowered down the hole as jetting takes place through both pipes. Before the second jetting pipe is withdrawn coarse sand is added to the hole and this sinks through the rising water and silt to reach the bottom of the wash-bore to locally improve the porosity and to form a straining sand pack around the screen.

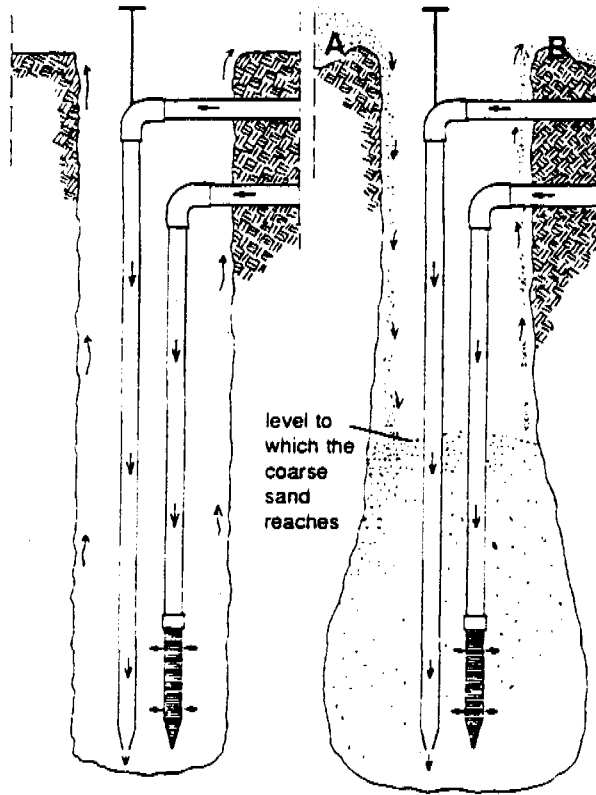

3.3.2.7

Jetting down. Note that water is pumped into both the jet probe and the well pipe. Right: Gravel packing. Coarse sand (A) sinks down through the rising column of water while fine sand and silt (B) is washed to the surface

(Wiseman, 1983) This is illustrated in Figure 3.3.2.7.

UNICEF has also been promoting wash-boring in Nigeria but using a hand rotated bit and water or mud pressurised by a 12HP pump. These are used in conjunction with a manually operated tripod and 3-5 ton winch which allows long heavy strings of jetting pipes to be removed from the completed wash-bore. The equipment can be locally fabricated in about 3 days in a suitably equipped workshop and is suitable for producing a 200mm diameter hole to depths even greater than 66 metres. Production rates of one 50m deep wash borehole every 5 days are possible each requiring about 2.5m³ of water if it is recirculated. The jetting equipment and materials for the subsequent completion of the borehole and handpump installation can be transported on a single axle trailer towed by a Land Cruiser or similar vehicle. The same vehicle can tow a bowser to supply water where necessary. One vehicle can serve up to 3 rigs. A 3 kV generator, welding plant and submersible pump are also required for each set of 3 rigs. (Donaldson et al. 1987)

Donaldson suggests that one geologist should be able to manage two experienced drillers who can each supervise three wash-bore rig teams, each consisting of one assistant driller and four local labourers. The field testing in Imo State, Nigeria suggested that the technology would also be suitable for riverine areas of Cross River, Rivers and Bendel States as well as the alluvial plains of the Niger, Benue and possibly other large rivers. In fact it is thought that it may be applicable throughout 15% to 20% of Nigeria. (Donaldson et al. 1987).

Ismail (1992) reporting on recent use of the technology described above stated that the typical cost of a 60m deep wash-bored tubewell is currently about US\$1,500. In some instances depths of just over 100m have been reached.

Sludger Method

A variation of the usual jetting technique which enjoys widespread use in the soft alluvial soils of Bangladesh, north-east India and in some parts of Nepal and Nigeria is known as 'sludging'. This method does not require a pump but relies on the reverse circulation of water and soil particles up a 40mm GI pipe as it is raised and

suddenly dropped into the ground using a scaffolding and lever. A man on the scaffolding places his hand over the top end of the pipe to form a valve system. The 'valve' is closed as the pipe is raised and opened as it falls to allow water and soil to cascade from the top of the pipe (Figure 3.3.2.6). The method is well described by Smith (1988), Carter (1985) and World Water (December 1979). Wells may be as deep as 50m and rates of progress can be as much as 10m per hour. UNICEF is reported to have funded the sinking of nearly 12,000km of uPVC pipe into Bangladesh's soil by this method (Carter, 1985). The cost of each well including the installation of the handpump was US\$100 in 1979.

Advantages and Disadvantages of using Wash-boring (Jetting) to construct Tubewells

The technique usually uses inexpensive lightweight equipment which is easily transported.

Most methods can be used in running sands which can be difficult materials in which to excavate hand dug wells. Since no dewatering takes place during construction instability of granular aquifers is not usually a problem and the additional positive head of the water added to the hole helps to provide additional support to the walls of the hole. Where necessary drilling mud can be used to provide additional support.

The disadvantages include the type of strata which wash-boring can penetrate. These are limited usually to unconsolidated silts, sands and fine gravels. The presence of thick layers of clay leads to very slow progress and coarse gravels may not be lifted by the rising water and may wedge against the jetting pipe.

In some strata the loss of jetting water can be a major problem unless adequate quantities of water are locally available or can be transported to the site to replace the lost water. The use of drilling muds can overcome this problem but their cost and availability often limits their use.

3.3.3 Raising Groundwater to the Surface

Although there are many successful methods of raising groundwater to the surface for the purposes of this research it is necessary to

investigate those which are cost effective for remote, scattered communities. For this reason electric powered pumps, whether from mains, generators or photovoltaics have been omitted from the discussion.

Raising water from hand dug wells **Bucket and Rope**

The problems of users contaminating the water in hand dug draw wells has already been mentioned, and to prevent Guinea Worm larva entering the well it is important that there is no opportunity for spilt water which splashes against lesions on infected people to re-enter the well. Faecal contaminants however can also enter on buckets and ropes which are handled by users with dirty hands or which come into contact with the ground. Some wind blown debris and dust can also carry pollutants into uncovered wells and hinged access covers are sometimes used to prevent this.

Whatever system of drawing water is to be adopted at a well it has to be acceptable to the users and most sanitary methods only allow one user to draw water at a time. Some communities strictly enforce the use of only one communal bucket for drawing the water and this is hung in the well or placed upturned on a post after use so that it does not come into contact with the ground although flies may still bring contaminants onto the bucket.

A windlass has the advantages that the rope can not come into contact with the ground and the bucket and rope is only handled once by the user. Figure 3.3.3.1 shows a simple windlass system and instructions to a community used in Zimbabwe.

If a windlass can not be afforded, or if it is desirable that more than one person uses the well at the same time, then the use of one or more rolling bars or pipes fixed across the well near to the edge makes water lifting easier and it helps prevent the chaffing of ropes on the edge of the raised wall.

In some situations a 'shaduf' (a pivoted counterweighted pole from one end of which the bucket is suspended by a rope or flexible pole) is appropriate and like the windlass this also prevents the rope coming into contact with the ground (Figure 3.3.3.2)

The 'Blair Bucket Pump' described on the next page can be used in a casing installed in a hand dug well (Figure 3.3.3.6). An interesting design feature of the casing is that it is closed at the bottom end but it has one 8mm diameter hole in the side, near to the bottom of the well which admits water fast enough to keep up with the removal of water by the pump. The advantage of this hole is that it does not allow much water to flow from the casing into the well chamber immediately following the impact of the bucket on the water. This reduces the chances of any contaminants on the bucket polluting the whole well because they are quickly removed from the casing with the water drawn out by the bucket. (Morgan, 1990)

Some interesting ideas about a purpose made steel cage bucket holder to allow the use of a variety of containers as buckets and increase the life span of well bucket handles are given by Carty (1990).

Handpumps

All hand dug wells can be equipped with handpumps and undoubtedly, providing a concrete cover slab to a hand dug well, or constructing a 'cased well', and installing a handpump is the best way of protecting the groundwater from contamination. However where wells are covered and equipped with handpumps then the provision of an lockable access hole in a small raised parapet is also recommended (Figure 3.3.3.6). This will allow buckets to be used in an emergency if the pump can not be repaired, but every effort must be made to make sure that the type of pump and procedures for maintenance and repair make such a breakdown very unlikely.

Hand dug wells are often used where the groundwater is relatively near to the surface making the use of simple handpumps appropriate.

If the water is always within about 7m of the surface then a suction handpump can be used. This need not be directly mounted above the well but can be offset from it if bends are used on the suction pipe (Figure 3.3.3.3). One of the problems with suction pumps is the loss of prime due to leaks from the suction check valve. This can lead to the practice of users using

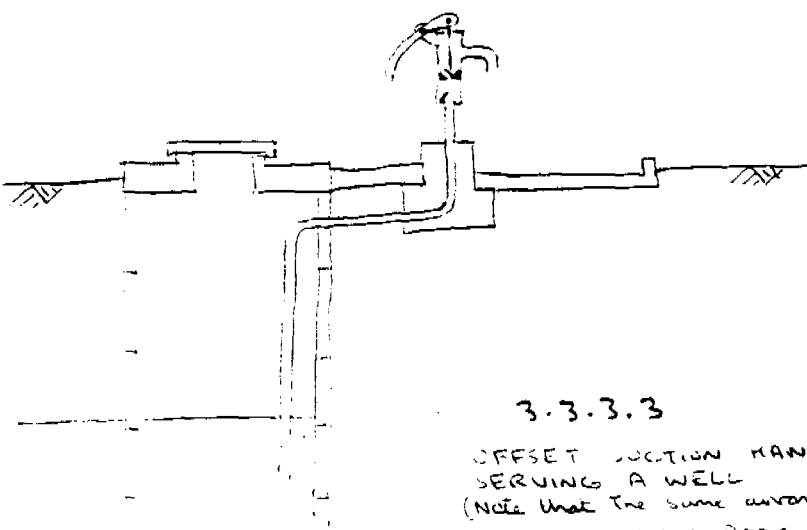
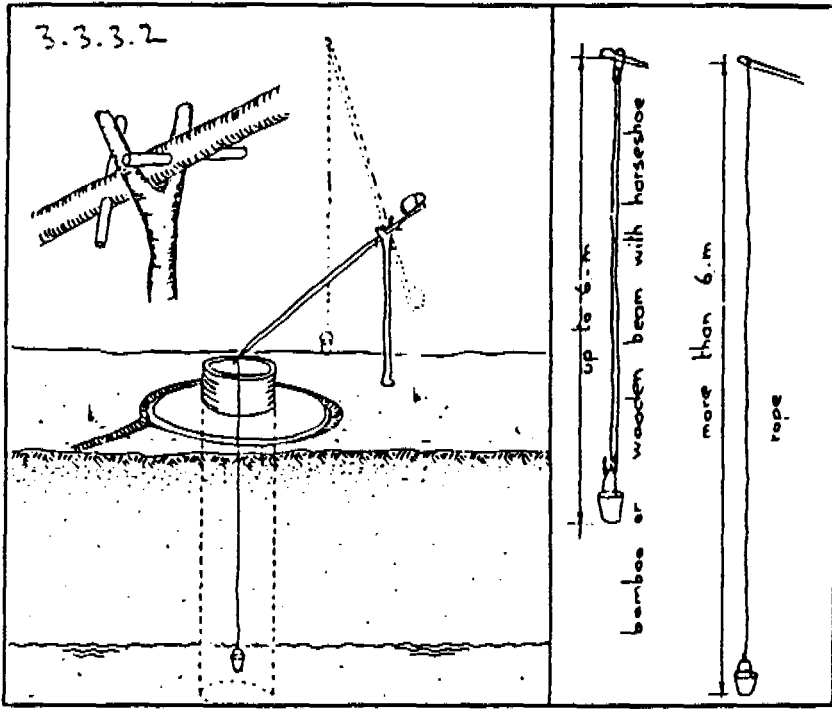
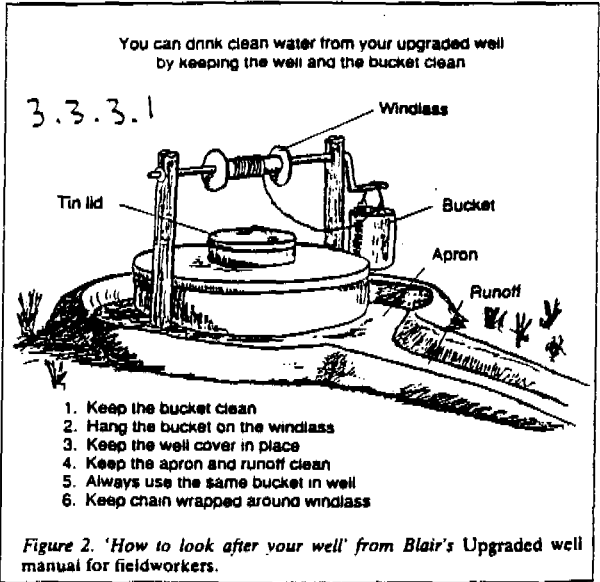

contaminated water to reprime the pump thereby spoiling the quality of the water subsequently drawn from the well. A UNICEF sponsored improvement to this valve on the Bandung pump in Indonesia has led to dramatic improvements in watertightness and valve life which mean that even after extensive use the prime is retained for very long periods (Mudgal, 1992). Similar improvements could no doubt be made to other suction pumps to overcome this weakness in their design.

In areas where the general trend is for the groundwater level to fall, care needs to be taken when using suction pumps since they may soon become unsuitable because of the excessive lift. In this respect seasonal variations in groundwater level are also important.

Another type of handpump particularly appropriate to situations where the groundwater does not have to be lifted more than about 12m is the direct action type of handpump. These are light and easy to install and maintain at village level and give high rates of delivery. The operator pulls and pushes directly on a 'T' bar connected by a rod to the piston which is in the rising main below the level of the groundwater (Figure 3.3.3.4). The rod often consists of a hollow plastic pipe which floats in the water held in the rising main causing a reduction in the lifting force needed to raise the water (Figure 3.3.3.5). Two designs which have been widely used to date with good results are the Tara and the Nira AF85. The latter is soon to be manufactured in Ghana by a new company called Ghanira Ltd. (Baumann, 1992). Both use corrosion resistant downhole components, mostly plastics, so are suitable for use in corrosive groundwaters.

It should be noted that the widely used standard India Mark II handpump, which was designed as a deepwell pump, is not very suitable for wells where the total length of the 12mm diameter operating rod string is less than 25m (Inalsa, undated). This is because the chain link at to the top of the rod string is unable to push the rods down against the frictional resistance sometimes experienced between the piston seals and the cylinder wall, and which in shallow wells can exceed the weight of the string of standard rods. The use of 16mm diameter rods can overcome this problem as long as the total

length of rods exceeds 15m, and the piston can then move down under the force of gravity. Fixed link versions of the India MarkII are also available but much simpler and more easily maintained pumps such as those described above are usually more appropriate for shallow lifts.

Long rising mains suspended in large diameter wells can swing from side to side when the pump is operated and this can lead eventually to damage or failure of pump components. However the rising main should not be clamped to the wall of the well unless an open topped cylinder with removable foot valve is used. If a traditional cylinder is used then a short section of casing pipe can be fixed near the bottom of the well so that the rising main or cylinder passes through the casing. This casing limits the sideways movement of the rising main yet allows the main to be easily withdrawn for maintenance. An alternative is to clamp a projecting rod to the side of the piston and then during installation this rod can be pushed into the sand or gravel at the bottom of the well.

The reference giving criteria for the choice of various types and makes of handpumps is 'Community Water Supply: The Handpump Option' (Arlosoroff et al. 1987). IRC Technical Paper No. 25 (IRC, 1988) is also recommended

Raising water from boreholes/tubewells Blair Bucket Pump

A normal bucket and rope is clearly unsuitable for small diameter tubewells. The Blair Research Laboratory in Zimbabwe has for some time been promoting the use of the 'bucket pump' mentioned earlier, which is based on a similar principle to the rope and windlass (Figure 3.3.3.6,7 &8). This name 'bucket pump' is a little confusing since it is used by others to describe a completely different type of pump which uses a rotating drive shaft and an endless chain of small buckets to lift water from a large diameter well. The design concept of the Blair bucket pump is quite different being similar to that of a typical 'bailer' used to remove water and mud from boreholes sunk using the cable tool (percussion) method.

The Blair bucket has a steel windlass with oiled wooden bearings which are usually supported by two purpose made steel support posts, although

3.3.3.4



Nsimbi Pump.

3.3.3.5

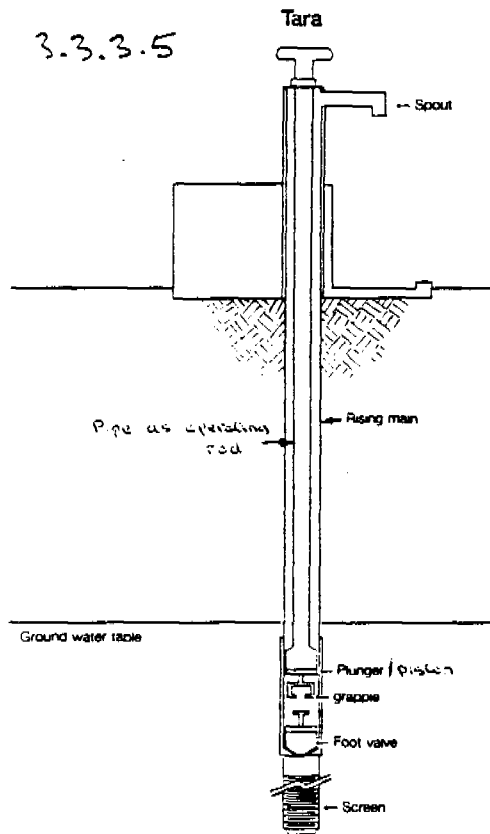

A direct action pump such as the Tara does not have a lever handle and bearing. The pumping mechanism is moved to a cylinder below the level of the groundwater and when the handle is raised the plunger lifts the column of water to the surface whilst the foot valve opens to allow the cylinder to refill. The pump is not limited by atmospheric pressure, though it is most efficient at depths of up to 15m. The pump rod is a hollow sealed PVC pipe, which, by using the effect of bouyancy, distributes the force required for pumping more equally between the up and down stroke.

Bucket Pump fitted on standard well.

3.3.3.6

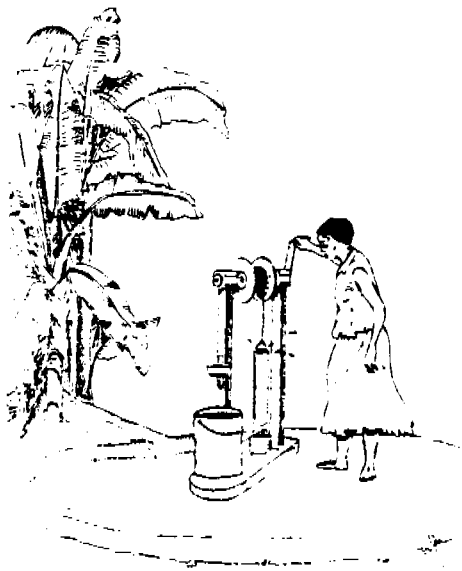
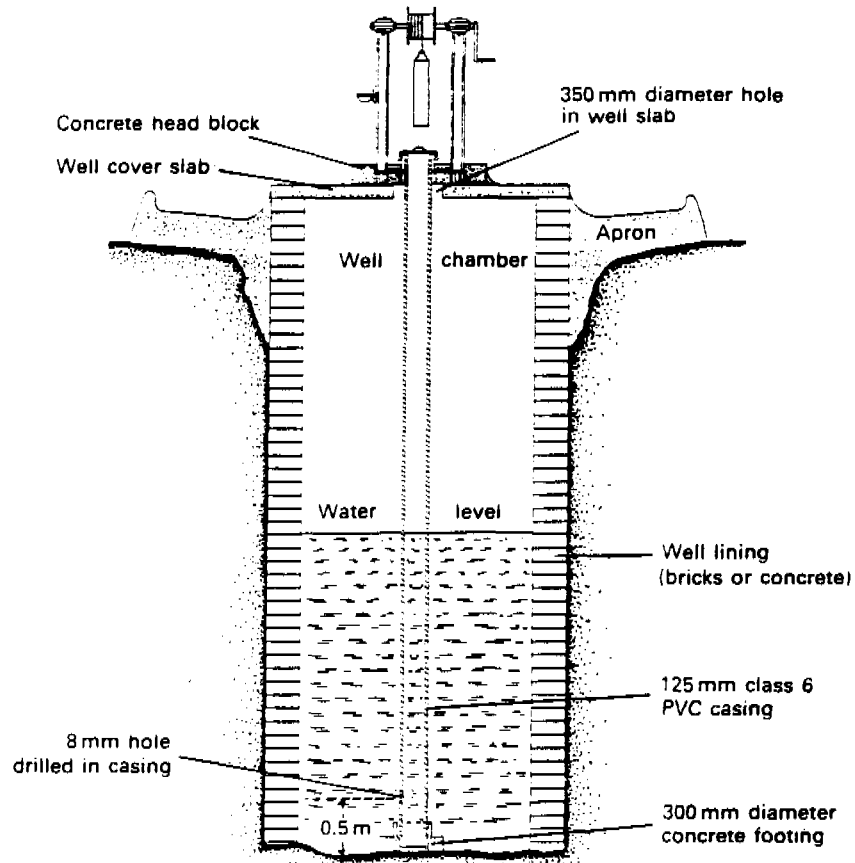

3.3.3.7

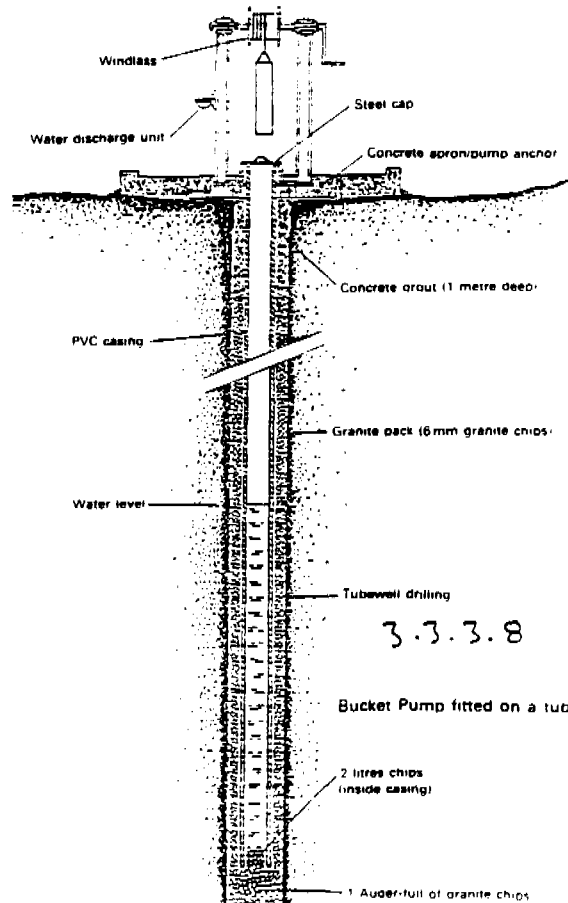

3.3.3.8

Bucket Pump fitted on a tubewell

timber ones can be used to reduce cost. A chain from the windlass is used to suspend a long thin bucket inside the borehole casing. The original bucket design used a 110mm diameter uPVC pipe 700mm long which gave sufficient clearance to the inside of a 125mm permanent well casing but more robust steel buckets are usually in use; both types have a capacity of about 5 litres. At the bottom of the bucket there is a simple valve which opens when the bucket hits the water and closes when the windlass is operated to lift it to the surface. At the surface the operator grasps the lifting loop at the top of the bucket, lifts it out of the borehole and places it on a metal funnel unit attached to one of the legs of the windlass. This unit has an attachment which pushes the valve up, causing it to open, so that the water in the bucket is discharged into the user's container below the funnel. Alternatively the bucket can be tipped to discharge the water through the top of the bucket but this procedure increases the amount of handling the bucket receives and hence the risk of contamination. When the bucket is not in use it rests inside the casing with a cap covering the head of the casing. (Morgan 1990)

The cost of an all steel bucket pump unit and the 125mm diameter uPVC casing suitable for a 15m deep installation if air freighted into Ghana from Zimbabwe would cost about US\$350 (V & W Engineering 1992). The pump could almost certainly be locally produced more cheaply in Ghana.

The time taken to draw water obviously increases with depth and the windlass is more suited to shallower depths of groundwater and it is rarely used beyond 15m lift. The small capacity bucket means that the windlass has to be operated to raise and lower the bucket three or four times to fill a normal sized container and this can frustrate users especially with deeper installations. It is probably therefore only suitable for family or multi-family groups and Morgan (1990) suggests that it should only serve between 30 and 60 individuals. However if cheap methods of borehole construction are used together with the relatively cheap bucket pump it may prove to be economical to install a large number of them to meet the needs of a larger community. This would be necessary in any case in slow yielding aquifers.

Despite the need to always handle the bucket, field testing in Zimbabwe has shown that in practice the resulting level of contamination in a tubewell is not very high. Frequent testing of a number of installations over a period of a year showed that the levels of Faecal E. coli in many cases were zero and that the count rarely exceeded 15 FC/100ml (Morgan, 1985). This may be in part due to the very high rate of turnover of water in the casing and gravel pack which quickly removes the contaminants and the smooth surface to the casing both of which reduce the potential for the multiplication of bacteria compared to a draw well (Morgan, 1990).

Field experience in Zimbabwe, where by 1988 over 1500 units were in service shows that the chain should last for 6 years and the bucket for four years when the pump is used by 30 people but that these periods reduce to three and two years respectively for use by 60 people. The chain wears more rapidly at the bucket end and thus may only require partial replacement. The leading edge of the bucket wears the most and to save cost this can be replaced by a new 'leading edge/valve unit', which is riveted onto an existing bucket. Usually all maintenance can be carried out at village level and spares are very cheap and easy to produce in-country. Because the pump is simple and easy to understand many repairs can be improvised using wire, bent nails, pieces of car inner tube etc.

Naugle (1992) reports the use of a 110mm diameter bailer bucket but one 2m long with a capacity of 18 litre, which is used in Niger to provide irrigation water from 140mm diameter casings. The bucket is raised using either a tall winch frame or a simple shaduf. The second option is a very interesting idea which may be suitable as a cheaper, easily repaired lifting device for use with the Blair bucket to raise water for domestic use. The large capacity bucket is also of interest in view of the limitations on the rate at which water can be raised using the small Blair bucket which were discussed above. However some aquifers will be unable to yield water fast enough for the larger bailer.

Suction Pumps, Direct Action Handpumps and permanently installed Rising Mains

One cost effective way of installing these handpumps in suitable high yielding aquifers is to avoid the use of permanent casing to the borehole by installing only the suction pipe or the rising main pipe in the tubewell. To give the groundwater an easy flow path into the pipe it needs to be connected to a suitable length of screen which may be wrapped in geotextile and/or surrounded with gravel pack or coarse sand. The SWS well jetting technique explained earlier is one method of installing such a length of pipework and screen but it can also be installed in any self supporting borehole. In less stable strata installation is possible using temporary casing which is extracted as the tubewell is carefully backfilled with coarse sand or fine gravel.

The valve and piston of a suction pump are both above ground so they are readily accessible for maintenance and there is therefore usually no need to remove the suction pipe and screen from the ground and this pipe can therefore be installed in the manner describe above without causing subsequent maintenance problems.

Direct action pumps usually have open-top cylinders which allow the piston to be withdrawn through the rising main without the need for this pipe to be removed from a borehole. If the footvalve can also be removed through the rising main, as for example is possible with the Tara handpump, then the usual maintenance procedures will not be affected by the rising main acting as a permanently installed casing. In fact the Tara has been installed in this manner in a large number of installations in Bangladesh where the pump is produced. Unfortunately most of the other direct action handpumps such as the Nira AF85, the Wavin and some types of the Blair do not have such extractable foot valves.

One disadvantage of the directly installed rising main system is that the screen, cylinder and rising main cannot be removed from the ground. It should be noted that removal of the screen should never be necessary if it is properly designed for the grain size of the aquifer and the well is properly 'developed'. (Development is often achieved by pumping water out at a high rate in stop start surges to create a natural graded filter in the aquifer around the screen.)

The cylinder should not usually need replacing. It could wear if it was abraded by sand particles but these should be held back by a properly designed screen. Even if the cylinder did wear the rapid movement of the piston would mean that the pump would usually continue to deliver water. In fact some direct action pumps like the Blair have no seals at all between the wall of cylinder and the piston block.

In direct action pumps where the cylinder is an unlined uPVC pipe, should such excessive wear take place that the pumps performance was badly affected, it would be possible to shorten the operating rod to make the piston operate in an unworn section of the pipe. The design length of the cylinder pipe could be made extra long to allow for such an eventuality if it was thought likely to be a problem.

Replacement of the rising main could be necessary if it became worn due to abrasion from the rising main. This is most unlikely to happen and could be guarded against by having replaceable sacrificial centralisers on the pump rod.

One possible problem with the permanently installed rising main system relates to the need to ensure that it remains as straight as possible during the backfilling of a tubewell. However, although the 63mm plastic pipe often used for rising mains is fairly flexible problems in the field with bent rising mains have not been reported in the literature read during the preparation of this report.

Deepwell Pumps

In the past the performance of many handpumps used with community water supply systems was often very poor. In recent years considerable effort has therefore gone into designing improved handpumps to overcome the main problems of the older designs of pump (Arlosoroff et al. 1987). The development of improved suction pumps and new direct action pumps has already been referred to but beyond 12-15 metres lift a direct action pump usually becomes too difficult to operate and deepwell pumps are needed.

Deepwell pumps, like the direct action pumps, have a cylinder below the ground water table, and usually have a lever handle to make it

convenient for the operator to exert enough force to lift water from depths much greater than 15m. However as the lift increases so does the difficulty experienced in operating the pump and the increased forces on the pump components increase making it more difficult to design an economic pump suitable for village-level maintenance. Most types of deepwell handpump can be used up to lifts of about 25m but a much smaller number are suitable up to 45m and very few are satisfactory at lifts much beyond this depth.

Arlosoroff et. al. (1987) compare a large number of different handpumps in discussing the important points to be considered when choosing between handpumps. Briefly these are:

The maximum pumping lift. Obviously the pump needs to be suitable for the maximum lift (including drawdown and seasonal variations). Although deepwell pumps can be used in the range of lifts up to 15m the use of the simpler direct action pumps should be considered up to this depth.

The daily output required per pump. Usually it is prudent to limit the number of people relying on the pump to a maximum of 250 and if possible to have two pumps available in a village so normal users of a broken down pump can use the other while their pump is being repaired. Some designs of handpump are only suitable for a few families and should never be used as community pumps.

The type of maintenance system to be used. The Village Level Operation and Maintenance (VLOM) system is showing the most promise as a sustainable maintenance system for handpumps. This system requires a handpump specially designed for easy maintenance by villagers and an effective means of distributing essential spares.

The minimum rating needed for corrosion resistance. Aggressive groundwaters are a problem in a number of the countries where Guinea worm is endemic.

The use of expensive corrosion resistant stainless steel rising mains and rods has frequently been necessary to replace galvanised iron components normally used with many

designs of handpumps. Although expensive, the stainless steel pipe has the advantage that it is much lighter than galvanised pipe, making cylinder removal from the borehole much easier. In 1990 the modified India Mark II, which uses stainless steel pipes and rods had a unit price of US\$900 for a 20m setting in Ghana (Baumann, 1992). The use of plastic rising mains is considered below.

The minimum rating needed for abrasion resistance. Boreholes should be properly designed to prevent the ingress of sand particles which can damage pump components. Where sand is likely to enter a pump, such as when pumps are to be installed in old poorly constructed boreholes, a handpump with abrasion resistant features (such as nitrile rubber piston seals) should be chosen.

The potential for manufacture of the whole handpump in the country of use should be investigated. If this is not possible then it may still be possible to manufacture the spares commonly needed for its maintenance. In-country manufacture of handpumps and spares is very important to the sustainability of handpumps in developing countries. As previously mentioned the Nira AF85, which has a very good track record in the field is shortly to be produced in Ghana. Mali is reported to be manufacturing the India Mark II. The SWS suction pump is being assembled from a mixture of local and imported components in Nigeria. It is not known if any other countries in which Guinea worm is endemic also produce handpumps which have given sustained good performance but the existence of local manufacturers should always be investigated.

Cost effectiveness also depends upon standardisation. If a country standardises on one or just a few types of handpumps to suit the different operating conditions experienced in the field, then it makes proper stocking of spares and training of handpump caretakers and mechanics much easier. However the choice must be made very carefully in view of the many factors which need to be considered to find the best pump. It should be noted that standardisation of pumps can lead to increased potential for in-country manufacture because the demand for the pump, or pumps, chosen will increase. The experience of countries such as

Bangladesh (with the Tara) and Pakistan (with the Afridev) showed that rather high initial production costs were rapidly reduced when the pumps were produced in bulk and different manufacturers were encouraged to compete.

Plastic Rising Mains

Plastic rising mains can be very cost effective, particularly in corrosive groundwaters where the alternative would be costly stainless steel. However there are a number of particular aspects that need to be considered if plastic is to be used.

In particular it should be noted that a number of problems have been experienced with many of the pipe jointing systems tried to date and with the connection between the plastic pipe and the metal pumphead. On long plastic rising mains long term creep, leading to a change in the position of the cylinder relative to the piston, can also be a problem with short cylinder lengths.

Glued joints to the rising main can be used with pumps which have open top cylinders with extractable foot valves because the main does not need to be removed from the borehole. The UPM pump which uses a lever, rope and pulley to raise the piston in an open top cylinder is reported to have performed well with 57mm uPVC rising main at settings as great as 60m (Bauman, 1992). However to obtain a reasonable rate of discharge at such deep settings needs up to four people to operate the handle (PMI, undated).

Where a traditional large diameter cylinder is to be used with small diameter plastic rising main glued joints can not be used and the pipe will need joints which can be dismantled to allow the main to be extracted to bring the cylinder, piston and foot valve to the surface for maintenance. Normal threading of uPVC for pipe joints has usually failed unless pipe wall thickness exceeds 10mm (Baumann, 1992), but a connector with injection moulded rounded threads has been produced by Enternap in Abijan, Cote d'Ivoire for use on 50mm outside diameter uPVC pipes. This has been field tested with the India Mark II in Mali with pumping lifts of up to 25m, and indications are that this design gives reasonable performance (Baumann, 1992).

It should be noted that the use of plastic rising mains of smaller diameter than the cylinder usually leads to compression in the pipe on the upstroke (due the pressure acting on the reducer at the top of the cylinder and to friction at the piston seals) and followed by tension on the downstroke (due to the whole weight of the contained water). This can cause a 45m rising main to extend and contract by as much as 30mm. Since this means that the cylinder also moves by this amount this change in length adversely affects the rate of discharge (cit.ibid).

Polypropylene and ABS are less 'notch sensitive' than uPVC and some pumps make use of these plastics. The Nira AF85 direct action pump uses high density polyethylene (HDPE) pipe. The Vergnet foot pump which operates using hydraulic pressure to inflate a rubber diaphragm uses twin polypropylene hoses which are delivered coiled. Consallen (1992) is unique in using threaded ABS plastic for the rising mains to its pumps.

In Nigeria threaded polyethylene joints moulded to uPVC rising main pipe with an outside diameter of 75mm and internal diameter of 65mm has been tried to produce an open topped India Mark III to allow the 2.5" diameter piston to be withdrawn through the rising main when it needs maintenance. The current situation concerning these joints which can just fit inside a 101mm internal diameter casing is unknown.

Current research and testing by the Consumers' Research and Testing Laboratories (CRTL), UK, under World Bank/ODA sponsorship, has identified two good dismantlable jointing systems suitable for 63 mm outside diameter uPVC pipes, suitable for use in borehole casing with an internal diameter of 102 mm. These joints are currently being field tested and the design should be available for potential manufacturers within a year. They are also carrying out work concerning possible improvements to the design and manufacture of the uPVC pipe material and the solvent cements used for joining some handpump rising mains. The behaviour of pump rods, including a design made from glass reinforced plastic (GRP), and pump rod centralisers is also being investigated to overcome the problems of buckling which can occur on the pump downstroke and which

sometimes can lead to wear of the rising main (Deveraux, 1992).

Afridev Handpump

One good lever operated deepwell pump which has emerged from a large amount of research, design and field testing is the Afridev handpump, the design of which is now in the public domain. It is in production in several countries including Kenya, Ethiopia and Pakistan. It is a VLOM pump which has an open top cylinder which is used with 63mm outside diameter solvent cemented uPVC rising main. The pump bearings are made from injection moulded plastics which are cheap to produce and easy for the villagers to replace every year. Unfortunately field experience has showed that under heavy use the bent stainless steel hook and eye rod connector design is not always reliable and the mild steel ones have given very poor performance. A forged stainless steel design gives much better performance and better quality control during manufacture would probably considerably reduce the rod failure rate which can be as high as 10% (Baumann, 1992). A useful feature of the Afridev pumphead is the fact that it has a flange which is suitable for bolting directly onto an India Mark II should it be necessary to replace such a pump.

It should be noted that a number of failures of the Afridev in the field have been due to some manufacturers not complying with the approved specification and due to poor quality control during manufacture (Wurzel 1992). Pump purchasers need to check these aspects when purchasing from a manufacturer.

The current price in Ghana for an Indian produced Afridev, complete for a 30m setting, is about US\$700 (Baumann, 1992).

Experiments are been made to produce a direct action version of the Afridev, using the same cylinder and footvalve components as the deepwell version. If successful this is an ideal situation since identical downhole components can be then be used for both types of pump to cover the whole range of operating depths up to 45 metres. Unfortunately at the time of writing no detailed information has been found concerning this development which was reported to have taken place in Kenya and Mozambique.

Using the rising main as a permanent casing

Direct installation of direct action pumps without using a permanent borehole casing was described above. Open top deepwell cylinder pumps with extractable footvalves can be installed in a similar manner if the aquifer is suitable. Experiments have been carried out in Kenya using the Afridev in this way but to date no details of their performance have been obtained. Consallen (1992) produce an interesting cylinder for their 'Consallen Directly Installed System' CDI. This unique design allows the piston, the footvalve or if necessary the whole stainless steel lined cylinder to be extracted through the rising main. This overcomes one of the foreseeable problems of using rising main without a borehole casing. Other possible problems with directly installed rising mains for deep well pumps are similar to those discussed when considering shallow pumps above.

4. COST EFFECTIVE RAINWATER EXPLOITATION

SECTION SUMMARY

Rainwater is pure, and if collected from an elevated surface such as a roof and stored in an hygienic manner it is usually suitable for drinking without treatment and offers no risks of the transmission of Guinea worm disease.

- The main disadvantage of its use is that there is usually a need to store a large volume of it for consumption during periods when there is no rain. If only water for drinking purposes is stored and traditional sources are used for other purposes the volume of storage is greatly reduced.
- If rainwater is captured from the roof of the user's house there is the advantage that the storage can be placed conveniently close to the point of use and if the storage is above ground, the water can be collected hygienically from a tap or hose.
- Where roofs to buildings are not suitable, cheap temporary catchments of woven plastic sacks may be feasible.
- The annual rainfall figures and rainfall pattern for many of the areas of countries in West Africa where Guinea worm is endemic are high enough to suggest that rainwater catchment is a potential source of potable water.
- Simple cement jars with hygienic draw-off hoses can provide cost effective storage for potable water supply.
- Where the materials are available in the country the use of galvanised iron sheets and galvanised wires for the DANIDA design of suspended gutters is likely to be cost effective.

4.1 Raised Catchment Surfaces

This section considers the cost effective exploitation of rainwater collected from elevated surfaces as a source of water for domestic use. The use of rainwater collected from ground level surfaces is discussed in the Section 5.6.

4.1.1 Roofs

The roof to a domestic dwelling is the commonest forms of raised catchment. There are a wide variety of roofing materials and roof shapes, some being more suitable than others for rainwater catchment:

Mud roofs and thatch roofs

Roofs of mud and thatch are generally not very suitable catchment surfaces because they usually contribute contaminants to the runoff throughout the period of rainfall and they usually adversely affect the taste and colour of the water. Furthermore thatch is not impermeable and some rainwater is retained in the roofing material reducing the amount which can be captured for domestic use. It is usually difficult to provide gutters for thatched roofs, especially for circular buildings.

However some communities have traditionally collected water from thatch and mud roof surfaces so their use for drinking water is possible if the water is accepted by users, but because 'first flush' diversion systems will not remove much of the contamination on the roof the bacterial quality of the water is likely to be lower than that from impermeable surfaces. The use of charcoal and sand filters to remove colour, taste and other contaminants is theoretically possible (Edwards et al. 1984), but it is not known to have ever been practised on a wide scale. It should be considered impractical and unsustainable until proven otherwise.

Tiled or sheeted roofs

Tiled or sheeted roofs are much better than thatch ones since nearly all the water falling on the surface runs off. That is they have a high 'runoff coefficient', which is the ratio of the amount of water collected from the roof to that falling on the roof. However, if an impermeable roof has very poorly installed guttering, or guttering which is too small for peak flows in very heavy storms, it will not be possible to collect all the water so the overall runoff coefficient should take into account the efficiency of the gutters and not just the roofing material.

Where galvanised corrugated steel sheets are too expensive for roofing some communities are

now using large fibre cement tiles produced locally by co-operatives using simply operated vibrating tables (Parry, 1992) but during the literature search carried out for this present report no projects were noted where the promotion of rainwater catchment was accompanied by the promotion of more affordable impermeable roofing materials. This is probably because in rural areas very few people can afford new roofing materials and a rainwater catchment system at the same time. However, in areas where only thatch is presently used, rainwater schemes using roof catchments will not usually be feasible until impermeable roofing materials are affordable.

4.1.2 Other Raised Surfaces

Where suitable roofs do not exist on dwellings or public buildings in a community, sometimes roofs without buildings have been built to capture rainwater. These shaded areas can then be used by communities for activities such as public meetings. Such catchments, 5m by 10m in size, have been used in northern Togo where the cost was about US\$900 (O'Brien, 1990a). These are combined with four $6m^3$ above ground cement brick storage tanks costing about US\$300 each to provide drinking water for up to 44 people at a unit cost of US\$53 per person served (cit. *ibid*) but all these figures exclude the village contributions of labour and local materials and the project-provided skilled labour. Lee and Visscher (1990) also discuss this particular programme and they note that although 60% of roofs in many of the rural villages are of corrugated sheets, that the project rejected the possibly cheaper cost of using existing roofs, due to the increased logistical requirements. They also note that cheaper methods of tank construction may now be available. The unit cost quoted above are compared by O'Brien to a cost of US\$47 per person served elsewhere by deepwell handpump systems which were not an option in these villages.

Smaller sizes of elevated sheeted catchments are sometimes designed to become the roof to a new house as in Botswana (Lee & Visscher, 1990) but the provision of such catchments on a large scale is likely to be very expensive.

In one part of Kenya, a very cheap, temporary, $6M^2$ elevated catchment made from woven plastic sacks which have been split open, sewn together and stretched over a frame has been used by villagers living in thatched houses to provide a catchment surface (Iles, 1989). This system is shown in Figure 4.1.2.1. This idea is worth replicating elsewhere where there are only thatched roofs. It would also provide additional catchment area to supplement the roof area of a tiled or sheeted roof to increase the volume of water captured from each storm.

4.2 The Quality Of Stored Rainwater

As previously mentioned human faeces are the source of many endemic diseases in developing countries. Unfortunately birds, reptiles and animals can carry human faecal pollution from ground level onto a raised catchment, and they can deposit their own faeces on the roof. Windborne dust may also carry faecal pathogens onto a raised surface. Therefore the debris washed off a roof during rainfall will not only affect the appearance of the water but also its bacterial quality.

Fortunately a number of studies have shown that although bacterial contamination in water from roofs is not uncommon, the level of contamination is usually very low and does not pose a major health risk (Wirojanagud et al. 1989). If a 'first flush' diversion system is used, such as those shown in Figures 4.2.1, 4.2.2 and 4.2.3, it prevents the initial flow of heavily contaminated water from the roof entering the storage vessel and the quality of the stored water is then considerably improved. If the water in the storage vessel it is carefully protected from contamination until it is consumption then its quality usually improves further during storage because many of the bacteria soon die off in the tank (cit. *ibid*).

The use of a mosquito mesh screen, preferably of stainless steel, at the entry to the tank is also recommended in order to intercept debris after the first flush system has ceased to operate. An angled screen as shown in Figure 4.2.4 has the advantage of being to some extent self cleaning. The removal of organic pollutants, whatever the method, is advantageous because their presence aids the survival of bacteria in the storage tank.

4.1.2.1

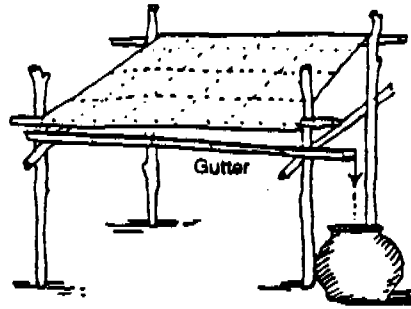

Stretched woven plastic sack catchment ('sarisa') used in Kenya
(Source: Lee & Visscher 1990 after Iles 1989)

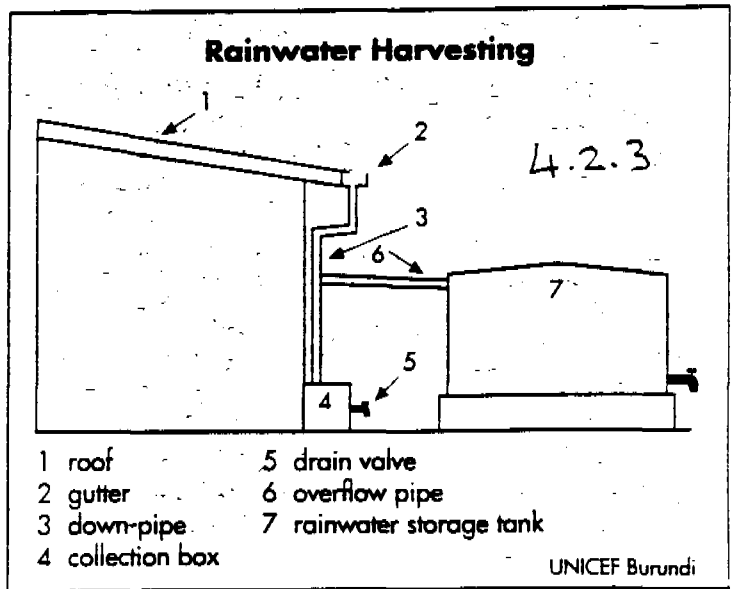
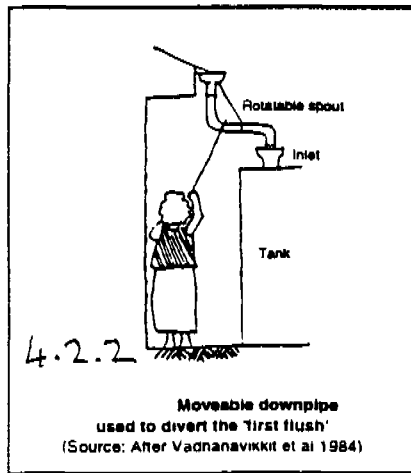
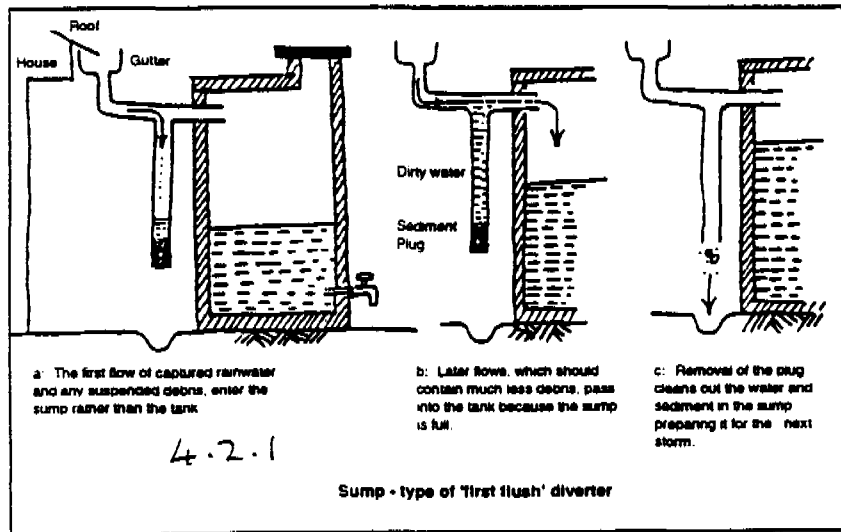

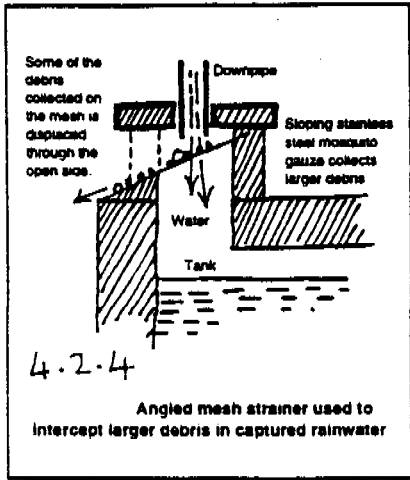

Unpolluted water which enters a storage tank can be contaminated during storage. The roof of a covered tank needs to be of a good standard to eliminate small animals, amphibians, dust and mosquitoes. Uncovered tanks promote the growth of algae in the water and the breeding of mosquitoes which can transmit Malaria.

Poorly constructed buried tanks can allow polluted water from outside the tank to contaminate the contents.

The way in which water will be withdrawn from the storage tank needs to be carefully considered. If it is collected directly in containers dipped into the water contamination can easily occur, and for above ground tanks the use of a tap fixed to a pipe passing through the wall of the tank is recommended (Figures 4.4.2.2b and 4.4.2.4). Alternatively a siphon hose, with or without a tap, can be passed through the cover of the tank to deliver water (Figure 4.4.2.2c). Water collections systems for below ground tanks need to be similar to those for hand dug wells (see Section 3.3.3). As was explained in Section 2, attention also needs to be paid to the proper storage and use of drinking water in a home to ensure that the good quality water drawn from the main storage tank does not become polluted by the users before consumption.

Roofs, gutters, screens and tanks all need cleaning from time to time to avoid the build up of debris and contaminants.

From the discussion in Section 2 it should be clear that if people only consume rainwater from a hygienic storage tank then there is no risk of them being infected with Guinea worm larvae, and the chance of being infected by other pathogens is very low. However the change in habits necessary to make this occur in practice do not come automatically with the provision of a rainwater catchment scheme, and appropriate and sustained health education is necessary to bring about these changes especially if the taste of rainwater is new to users.

4.3 The Technical Feasibility Of A Rainwater Catchment And Storage System

The technical feasibility of a rainwater catchment and storage system to fully meet a given water demand depends on four factors:-

- * the area of the catchment available
- * the rainfall pattern over the year
- * the pattern of demand over the year
- * the volume of storage available

4.3.1 The area of the catchment

The product of the area of the catchment, the runoff coefficient and the plan area of a roof gives the volume of water captured from it. For example if a corrugated galvanised steel sheet roof is 30m², and the runoff coefficient is 0.9, then if during a year 729mm of rainfall falls on the roof a maximum volume of

$V = 30 \times 0.9 \times 729 = 19,683$ litres can be captured.

If this maximum volume is less than the total amount of water required during the year then the demand can not be met unless the catchment area is increased.

4.3.2 The rainfall pattern over the year

It is important that reliable monthly, or even better daily, rainfall records are available over a number of past years if an economic rain catchment scheme is to be designed for an area. Often the location of the nearest meteorological rainwater gauge(s) will not be convenient to the project area and initially only approximate rainfall figures can be used. However rainfall gauges should be installed in the project area as soon as possible to monitor daily rainfall so that designs can be amended if the amount of rain falling is very different from that expected. Fortunately very cheap, transparent, graduated, wedge shaped plastic rainwater gauges are now available from which daily depths of rainfall can be read by any literate person. This makes it feasible to collect reasonably accurate records from a number of gauges in an area to get average figures and to compensate for missed records at any station.

The relationship between seasonal rainfall patterns and the risks of being infected with dracunculiasis is discussed in Section 4.3.4 (see also Figure 1.4).

Lee and Visscher (1990) in their study of rainwater harvesting in four African countries (Botswana, Kenya, Mali, Tanzania and Togo) noted that in general rainwater harvesting (rooftop and ground level catchments) has potential for wider expansion in areas where the annual rainfall is between 200mm and 1000mm.

In areas with above 1000mm of rainfall they suggest that there is usually no need for rainwater harvesting due to the plentiful nature of surface and sub-surface sources. The low quality of the 'plentiful' surface water sources should have been noted at this point in their discussion. Unless an appropriate method of treatment is available for surface water, if groundwater sources are not available, then rainwater will always have good potential for supplying potable water. In such situations it is suggested that the higher the rainfall the greater will be the potential for the use of rainwater catchment. The treatment of surface water sources is particularly difficult on a small scale so rainwater is especially suitable for small villages and scattered households of rural areas where no groundwater can be exploited.

Lee and Visscher also quote Ongweny (1979) who suggests that for drinking water supplies surface catchments should be widely applied in the sub-humid and semi-arid areas, and rooftop catchment systems in the humid and sub-humid areas.

In view of their discussions cited above, Lee and Visscher illustrate 'zones where rainwater harvesting can be well applied' with the use a map of Africa showing the zones where rainfall is between 200 and 1000mm. The map in Figure 4.3.2.1 may be more helpful. This focuses on West Africa, where Dracunculiasis is most endemic. A comparison of Figure 4.3.2.1 with Figure 4.3.2.2 shows that most of the land in endemic countries lies in a zone where the annual rainfall exceeds 1000mm and virtually all the remaining areas of these countries are in the zone between 250mm and 1000mm. It is suggested that this is indicative of the high potential for rainwater catchment to supply the potable water needs of those small communities in these countries which cannot be economically or sustainably served by the alternatives of groundwater or treated surface water.

Surprisingly there is not much reported in literature published in English about rainwater catchment in these countries other than in Togo (e.g. O'Brien (1990a), Lee & Visscher (1990)) and Mali (e.g. Lee & Visscher (1990)). Figure 4.3.2.3 shows some representative mean monthly and annual rainfall figures for a few selected stations in West Africa. It can be noted that in general in those areas north of latitude 9°N there is only one rainfall peak, usually in August, and the wet season becomes progressively shorter with an increase in latitude (MHCE undated).

4.3.3 The pattern of demand over the year

A family's pattern of demand for water during a year is often assumed to be constant, whereas in practice it is likely to vary, especially if water is being used for livestock and small-scale irrigation in addition to uses in the home. Since high quality water is not needed for the latter two purposes cheaper methods of collection and storage of rainwater can be used for them and water for these uses will not be considered further in this section of the report. In fact the water for livestock and small-scale irrigation can usually come from unprotected traditional sources.

The amount of drinking water consumed per person varies somewhat with climatic conditions and drinking habits. Usually it falls within the range 3 - 5 litres/person/day. When considering water for all domestic uses, including drinking, the minimum domestic demand is 5 - 25 litres/person/day but for a good standard of hygiene a total volume of 30 - 40 litres/person/day, or higher, is recommended.

If, as is usually the case, the storage of all water used for domestic purposes is too expensive, then as an absolute minimum only water for potable purposes needs to be stored, and this is probably the best starting point for a new project. If the roof is of sufficient size, additional storage can be added at a later stage when it can be afforded. However, the human problem of the conveniently available stored rainwater being used for purposes other than for drinking needs to be addressed. If people are not disciplined the stored water may run out before the end of the dry season and they will have to return to drinking water from traditional polluted sources.

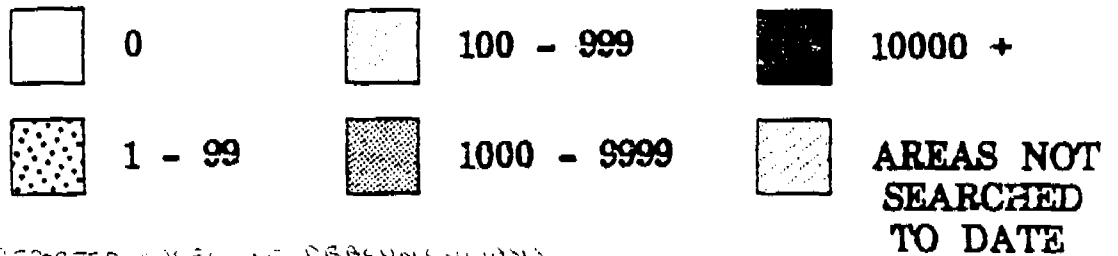
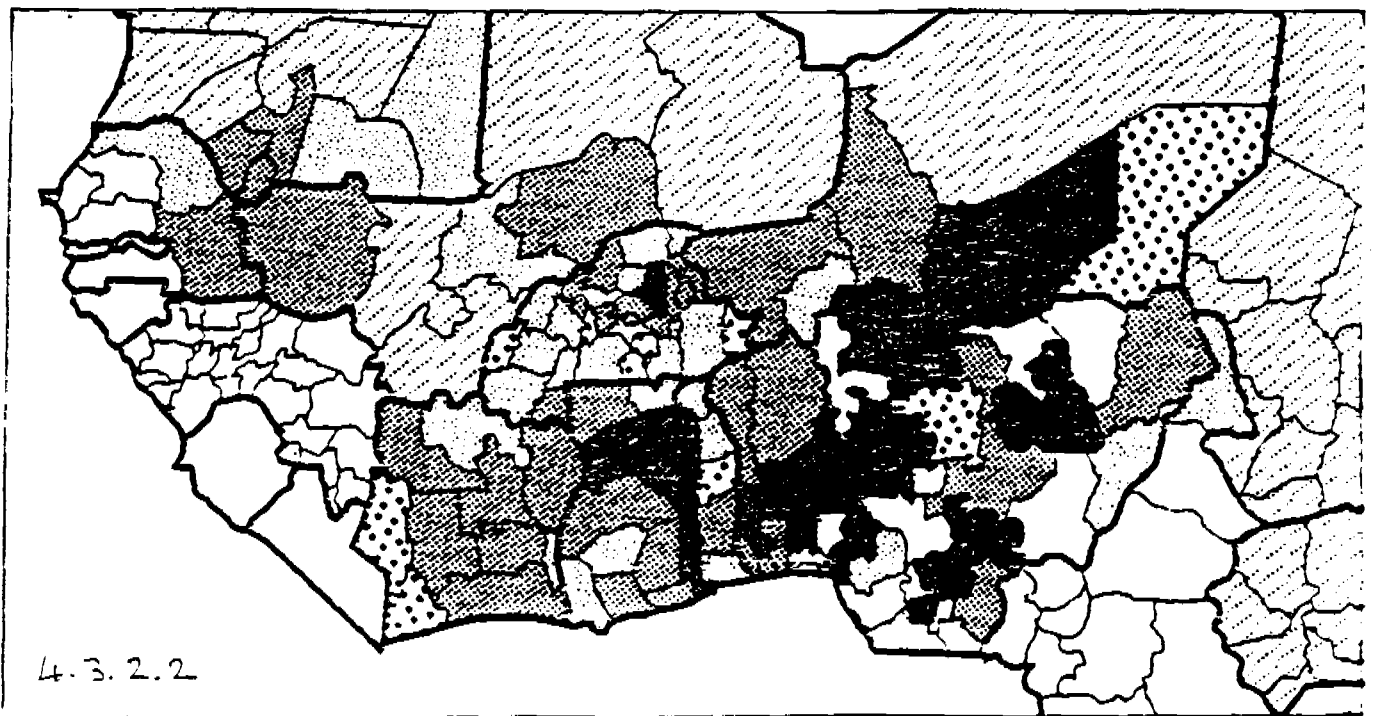
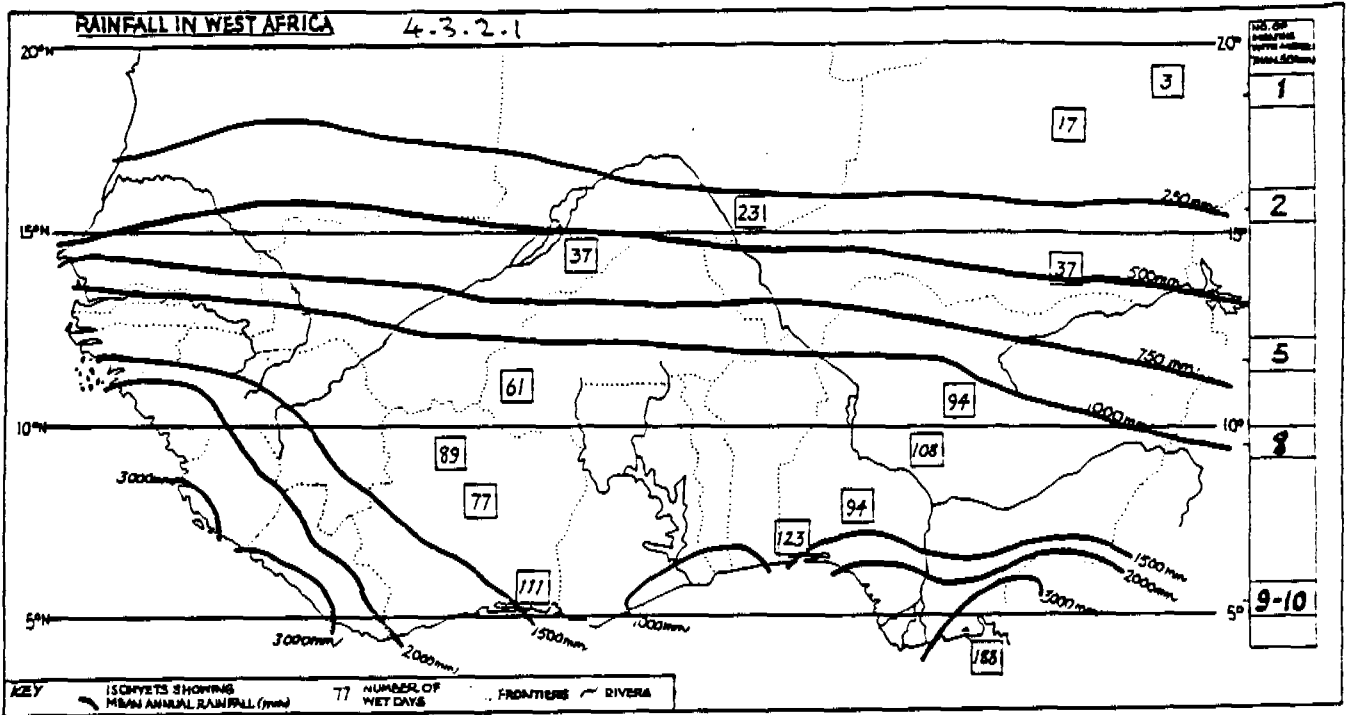

NUMBER OF REPORTED CASES OF DRACUNCULIASIS

RAINFALL IN WEST AFRICA
 MEAN MONTHLY AND ANNUAL
 RAINFALLS FOR SELECTED STATIONS

20°N

BILMA
23

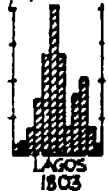
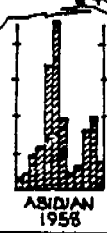
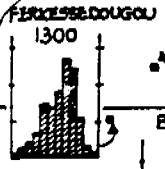
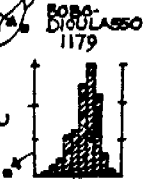
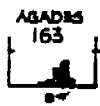

10°N

10°N

0 Km 200

4.3.2.3

KEY
 2496 . MEAN ANNUAL RAINFALL (mm)
 VERTICAL SCALE ON GRAPHS:
 1cm. = 200mm

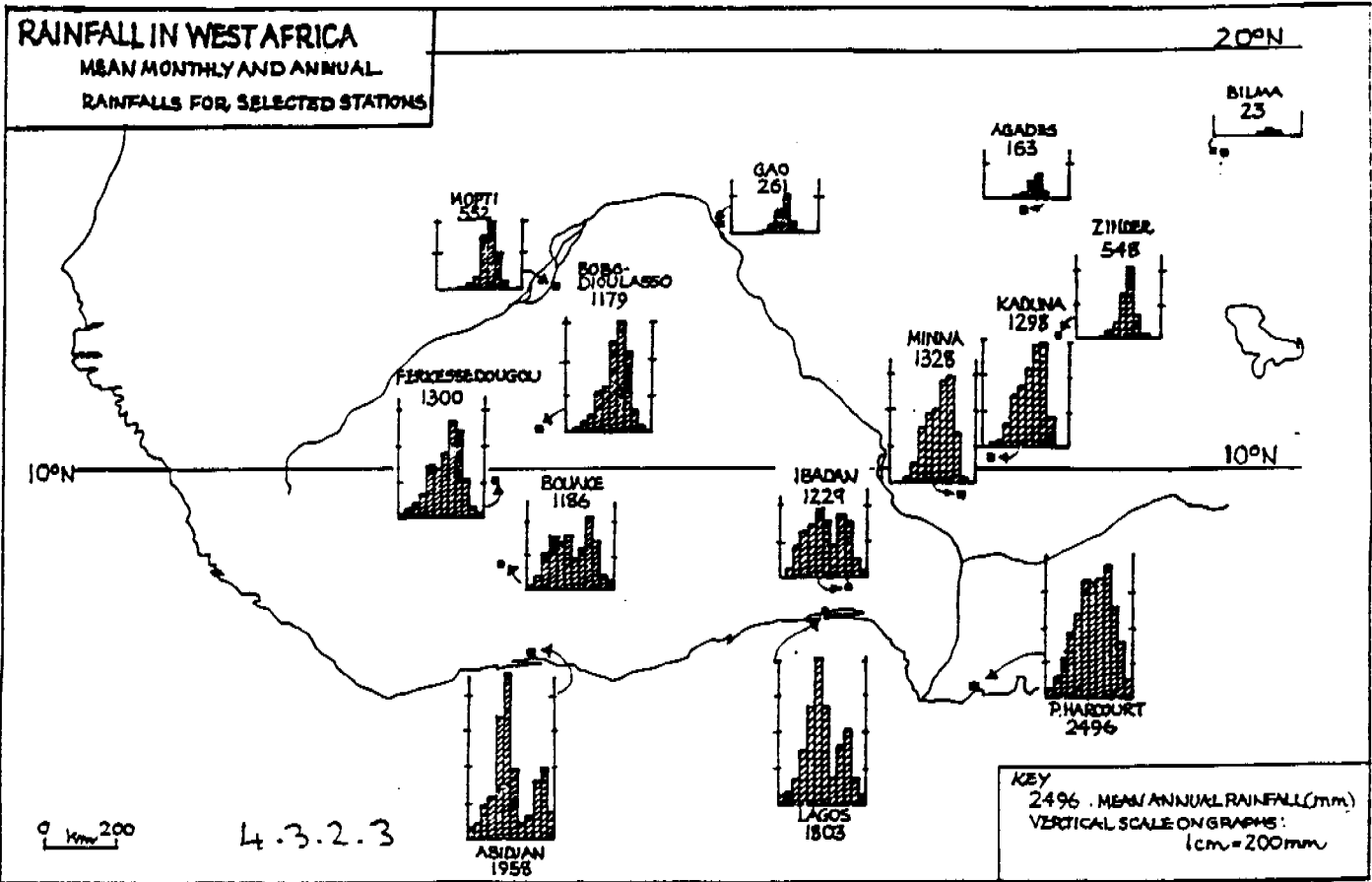

These will put them at risk of infection from Guinea worm larvae and other pathogens.

The usual lack of discipline in dedicating rainwater to potable use only is the main reason why catchments serving more than one family rarely work in practice but it has worked with some, but not all the communities in the Togo project cited above [Lee & Visscher (1990), O'Brien (1990a)]. However in many countries there has often been success in community storage at schools, hospitals and health centres because at such places use can usually be more strictly controlled, by lockable taps if necessary.

The fact that a strict rule is imposed by a family on the uses to which the stored water can be put during the dry season does not necessarily mean that these have to apply during the whole of the rainy season. When, during a rainy season, a tank becomes nearly full some water can be drawn off to make space for additional rainwater which would otherwise overflow. However the users need to have advice on this aspect and an easy method of monitoring the water level, such as a transparent hose (which can also be used as a delivery pipe as shown in Figure 4.4.2.3), needs to be provided.

The particular implications of the typical patterns of rainfall in Guinea worm endemic areas on the minimum volume of storage required are discussed below.

4.3.4 The volume of storage

If during a typical year there is a long period without rain then the volume of water stored to meet demand throughout this period obviously needs to be equal to, or greater than the volume normally consumed by the users during that dry period. However the patterns of rainfall and demand during a year often make calculations of the minimum volume required rather more complicated, but there is useful guidance on how to calculate this volume in a large number of publications dealing with rainwater catchment [e.g. Gould (1991), Institute for Rural Water (1982), Pacey & Cullis (1986), Edwards et al. (1984)]. It is suggested that graphical methods (mass curve technique) based on a chosen 'design year' rainfall pattern are the simplest approach (Skinner & Cotton, 1992).

The feasibility of storing drinking water only for seasons when infected copepods can be ingested

Where the main purpose of a rainwater catchment project is to avoid Guinea worm disease the volume of storage needs only to be sufficient to meet the drinking water needs during the period in which the traditional source is likely to contain infected copepods.

In semiarid regions that have distinct wet and dry seasons and minimal rainfall within 3-4 consecutive months, incidence of dracunculiasis often coincides with the rainy season (Muller, 1970). This means that volumes of storage may not have to be very large since water drawn from the tank during the rainy season is soon replaced.

In areas with longer periods of rainfall, dracunculiasis can be transmitted for as many as 8 months in any year but most cases occur in the latter half of the dry season and continue into the rainy season (Muller, 1970). This disease pattern would require sufficient water from the end of one rainy season to be saved for consumption from the middle of the dry season until the rainy season provided enough water to replace the daily demand.

Figure 1.4 shows a simplified map illustrating the peak seasons of transmission of Guinea worm disease. Note that Guinea worm is also transmitted just before and after these periods. Needless to say, the adoption of the idealistic patterns of storage and consumption discussed above is not at all straight forward and no references to projects promoting the adoption of such practices has been found during the preparation of this report. Also such a pattern of consumption will still expose people to faecal pathogens in the unprotected traditional sources which they have to use when they are conserving rainwater, a situation which should be avoided if at all possible.

4.4 Cost Effective Guttering And Water Storage

If a suitable catchment surface, such as a sheeted roof, is already available then water can be collected by placing containers on the ground under the edge of the roof to collect water during periods of rainfall. In fact many

communities already collect some water in this way although it may not be used as a source of drinking water. However this collection system is not suitable for collecting and storing all the water from a storm, and the water collected in shallow containers can be easily polluted by water splashing off the ground. More efficient and hygienic collection systems use some type of gutter to collect virtually all the water running off a roof and to channel it to a suitably sized storage tank. Both gutters and storage vessels can be expensive but there is potential for cost savings as detailed below.

4.4.1 Cost Effective Guttering

Supporting the gutter

In developed countries gutters are often supported by brackets fixed to the fascia board which runs along the ends of the rafters just below the edge of the roof. However, in rural areas of developing countries roof rarely have fascia boards so such a system is not usually suitable and other methods have to be used. Sometimes the gutter is supported on the top of vertical poles, often using forked branches to hold the gutter. Sometimes a horizontal timber is also used to help support the gutter over large spans between poles because it becomes very heavy when it is full of water. In other situations gutters can be supported on wooden or metal brackets fixed to the side of the rafter poles or to the walls.

One idea developed by DANIDA in Kenya which shows great potential is the suspension of gutters from a 'deflector plate' fixed to the edge of the roof. This is illustrated in Figure 4.4.1.1b. Not only does this neatly solve the problem of supporting a gutter on a roof constructed without suitable rafters or a fascia board, but it also improves the amount of water captured by the gutter during heavy rain as described below. The system is usually used with 'V' shaped gutters but it could be used with any type of gutter.

To obtain a sufficient rate of flow along a gutter it is usually necessary to install it so it has a longitudinal gradient. This gradient means that the level of the gutter becomes progressively lower and consequently further below the edge of the roof. With a long length of gutters there comes a point when it can no longer be fixed to

the standard fascia board, and/or it is positioned so low that the rainwater running off the edge of the roof during heavy storms is likely to overshoot the gutter as shown in Figure 4.4.1.1a. When a deflector plate and suspended gutter are used this problem does not occur since the water hits the plate and then falls down vertically into the gutter. The fact that with this system the gutter does not have to be very close to the edge of the roof means that it can be laid to a much steeper gradient, and therefore with a greater water carrying capacity, than is possible with one fitted to a fascia board.

Gutter materials

Gutters can sometimes be made from locally available materials such as split bamboos. Sawn timber planks nailed together to form a 'V' or 'U' shape or variously shaped metal gutters made by tinsmiths from recycled metal sheet can also be used, but all these materials have relatively short lives. Purpose made uPVC gutters although rot and corrosion resistant are rarely available and they, or the alternative of a plastic pipe cut in half, are usually quite expensive. Semicircular gutters made from galvanised steel bent to shape by tinsmiths, and often with bent edges to give longitudinal stiffness, are usually more readily available (at least in urban areas) but often they are also expensive.

To reduce water losses all gutter joints should be leakproof and this can be a major problem with many of the locally produced gutter designs. However if no suitable sealing material is available wastage can be considerably reduced by using a reasonable length of closely fitting overlaps and a good longitudinal gradient.

The simplicity of the DANIDA 'V' gutter system mentioned above has much to commend it. It can be manufactured from flat galvanised steel sheets by people with very little training using simple timber forms and clamps. Furthermore, since it is installed to steeper gradients than conventional gutters its erection does not require a high level of skill. The suspension system also has the advantage of allowing easy adjustments to levels to be made during installation or maintenance to correct any faults that develop. The manufacture, design and installation of this 'V' gutter system is well described by Nissen-Petersen and Lee (1990a). The same reference also describes a 'U' gutter system which is

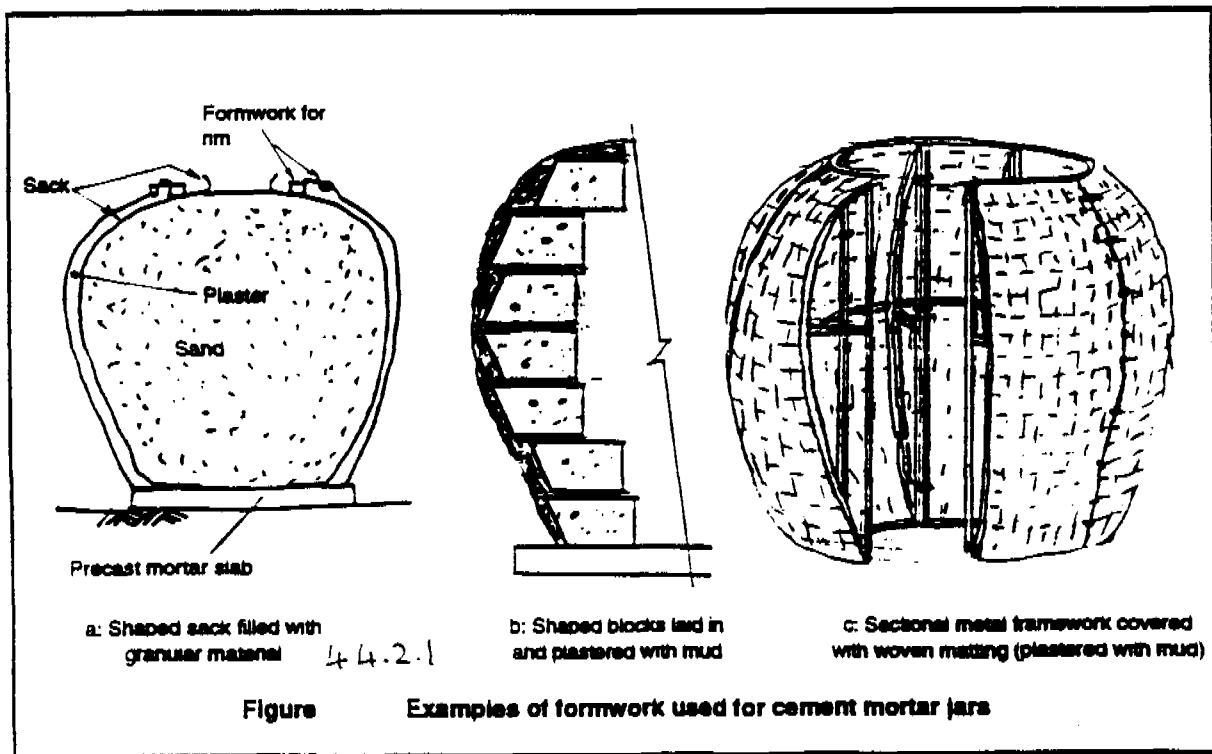
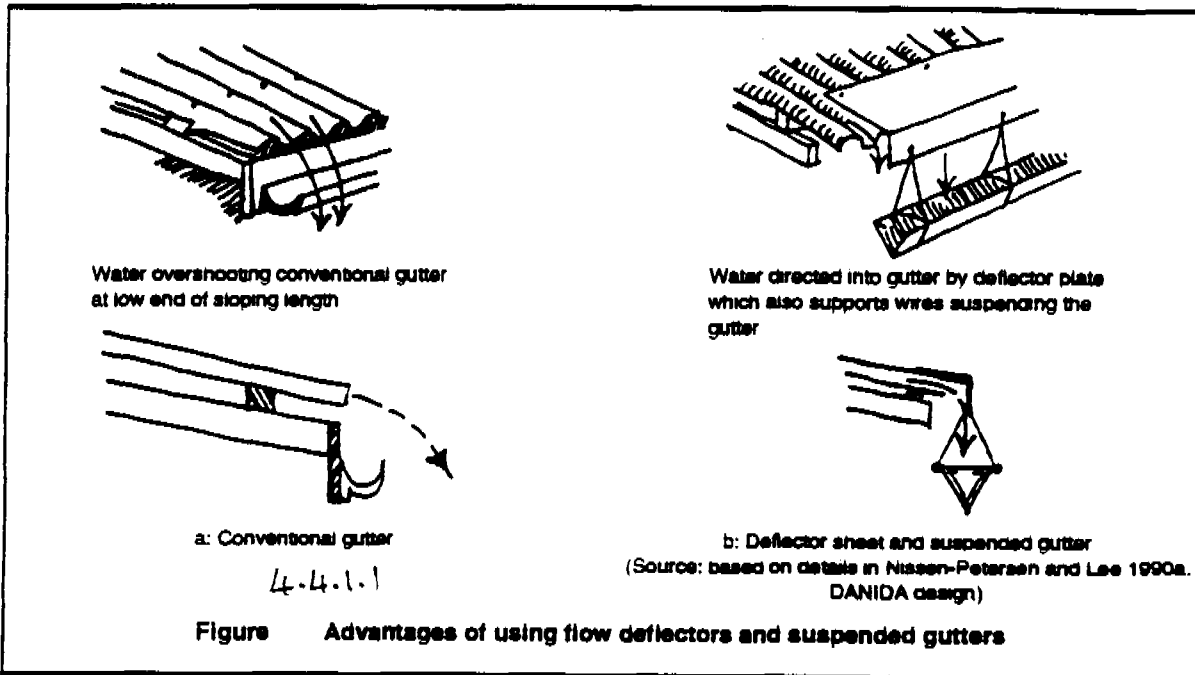

attached to a fascia board on one edge and is supported by a wire fixed to the roof sheets on the other.

In rural areas of developing countries there are likely to be only a few homeowners who can afford a complete system at the outset. Even if someone could afford it, until they are convinced of its usefulness they will not be willing to invest in such a system. However it should be noted that it is not initially necessary for a house owner to gutter the whole of his house. If he or she is offered advice as to the best site of a storage vessel they can at first add as much guttering as the house they can afford and then they at least collect some of the water falling on the roof. At later stages, if the owner is convinced of the advantages of a rainwater catchment system he/she can extend the guttering, and eventually add to the storage, to make the maximum use of conveniently available potable water. The disadvantage of this approach is that until enough guttering and storage is available to meet all the potable water needs of the family they are still at risk of disease from consuming water from unprotected traditional sources.

The water from the gutter needs to be channelled into the storage vessel. A vertical downpipe of adequate size is ideal for this purpose and it may be combined with one of the first flush diversion systems already discussed. Downpipes can be made from galvanised steel sheet by skilled tinsmiths, but the cost and availability of suitable pipes may mean that a steeply angled gutter running down from the roof to a screened opening into the vessel has to be used instead. Brick 'chimney' downpipes have been used on some projects in Kenya.

4.4.2 Cost Effective Storage Vessels

A wide variety of materials are available for the construction of tanks or vessels for the storage of captured rainwater either above ground or below ground. These nearly all use cement and include clay brickwork, concrete blockwork, stonework, concrete or ferrocement. Cylindrical corrugated galvanised steel tanks are one of the exceptions to this general use of cement but even these are best provided with raised plinths which will need cement for their construction.

An extensive literature survey has recently been carried out to study different construction techniques available for tanks and jars for rainwater storage (Skinner & Cotton, 1992). Two particular methods, cement mortar jars and ferrocement tanks, appear to be very cost effective in their use of cement.

Cement mortar jars

Mortar jars have been very widely used in Thailand where more than ten million 2m^3 jars are in use (Gould, 1992) and factory production is common with this size of jar currently being sold for about US\$40 (Brandford, 1992). These jars are typically made from 1:2 cement:sand mortar with a wall thickness which does not usually exceed 100mm and which is often much thinner. The cement mortar does not usually need reinforcement although with the larger jars widely spaced loops of wire are advisable especially if they are to be transported. The mortar is usually applied to a removable inner formwork (e.g. Latham, 1984, Bradford, 1992), for example as shown in Figure 4.4.2.1 and is very well cured to avoid cracking. The mortar surface is smoothed and waterproofed with a thin coat of cement slurry.

A UNICEF design for an unreinforced jar of 2m^3 capacity uses 4 bags of cement (UNICEF undated). A typical 2m^3 jar design from Thailand uses 2.5 bags of cement, 0.25m^3 of sand and 1.5kg of plain 1mm diameter wire (Wirojanagud, 1991). The latter design is extremely efficient in its use of cement, needing only 1.25 bags of cement per m^3 . This is better than virtually all the above ground ferrocement designs which for capacities of up to 15m^3 have cement usage rates usually not less than 1.6 bags per m^3 and to which the costs of wire mesh and sometimes bar reinforcement also need to be added (Skinner & Cotton, 1992).

Usually for a fixed volume of storage, a single larger tank would be expected to be cheaper than a number of smaller tanks with the same total capacity. This is normally the case if ferrocement or other materials are used for both sizes of tank. However unreinforced, or lightly reinforced mortar jars are not suitable for volumes much above 2m^3 so there are no further economies of scale available with this construction material. However it should be noted that the cost of a number of cement mortar

jars compared to the cost of a large ferrocement tank of equal volume usually show the jars to be the cheaper option. An important aspect of this cost effectiveness is that a householder can over a number of years add to his collection of storage jars to increase his total volume of storage without the usual disadvantage of missing out on the cheaper unit cost of a large tank.

There are some problems which occur with the use of a number of jars rather than just one large vessel which need to be recognised but often they are not insurmountable.

One problem concerns the provision of a suitable hygienic vessel filling system to suit all the jars from one downpipe. However, if two or more downpipes are necessary for the roof it can be an advantage to have a number of storage vessels compared to using a single large tank. This problem is avoided if separate sections of gutter discharge into each jar but water collection from a number of jars at different locations may then become difficult as noted below. Where there is only one gutter outlet the user will have to move a flexible section of the downpipe, or a gutter chute, to each vessel in turn. Making cheap, easy to use, hygienic connections to tanks with such a movable system is not very easy. Also if a heavy storm comes when the system is unattended some water might overflow from the jar being served. An overflow system where the overflow from one jar enters another is one way of overcoming this problem but the necessary pipework may prove expensive.

A second problem relates to the hygienic collection of water from a number of jars since it will probably not be cost effective to supply each one with a tap. An alternative is a small diameter siphon tube with a tap or a bung (Figure 4.4.2.2). One end of the tube is pushed through a small hole in the jar cover until it is below the water level inside the jar. A tap or bung is fixed to the other end on the outside of the jar. When the pipe is first installed it is necessary to suck on the tap or tube to fill the pipe with water but thereafter closing the tap or replacing the bung after use should maintain the siphon ready to deliver water when the tap is next opened. When necessary the siphon can be moved to another jar. Where it is affordable, or

there is only one jar a flexible pipe can be permanently fixed near the base of each jar. This pipe can be stored in the vertical position until water is required at which time the pipe is lowered until it delivers water (Figure 4.4.2.3). Transparent flexible pipe, although useful for showing the water level inside the jar may encourage the growth of algae if it is used outside a house.

A third problem could be the greater space which a number of jars take up near to the house compared to a single large tank.

All jars, whether used inside or outside the home should have close fitting covers. Large jars which cannot be easily tipped over when they are being cleaned out should be equipped with a washout pipe which is opened to drain the whole jar when necessary. A single outlet can serve both purposes if provided with a short section of removable pipe within the tank as long as this can be reached through the opening in the vessel (Figure 4.4.2.4).

Cement mortar jars, particularly those of smaller sizes than that mentioned above also have great potential for use in a home to hygienically store water from other sources than rainwater and to allow hygienic collection of the water by means of a tap and/or flexible pipe.

Ferrocement tanks

Ferrocement consists of a carefully cured cement rich mortar (e.g. 1:3) reinforced with layers of welded and/or woven wire mesh, sometimes with additional plain wire or steel rod reinforcement for added strength.

There are a wide variety of ferrocement tank designs around the world and many thousands are in use in Thailand and Kenya in particular. There are also some designs for plain wire reinforced mortar tanks using mainly circumferential wires which although strictly speaking should probably not be termed ferrocement will be considered here together with them.

Most ferrocement designs are for above ground tanks and capacities can be as great as 150m³ (Watt, 1978). Above ground tanks have the distinct advantage of allowing a tap for hygienic

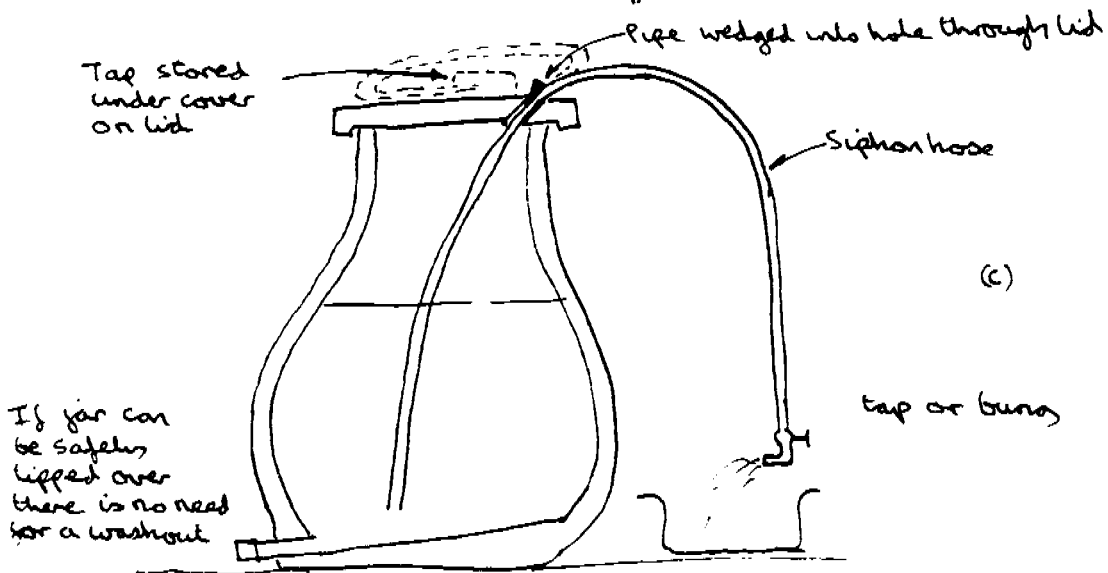
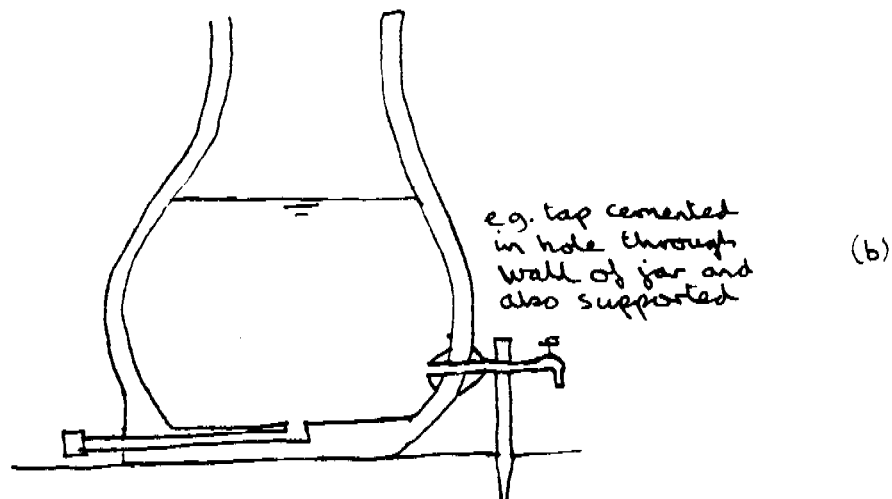
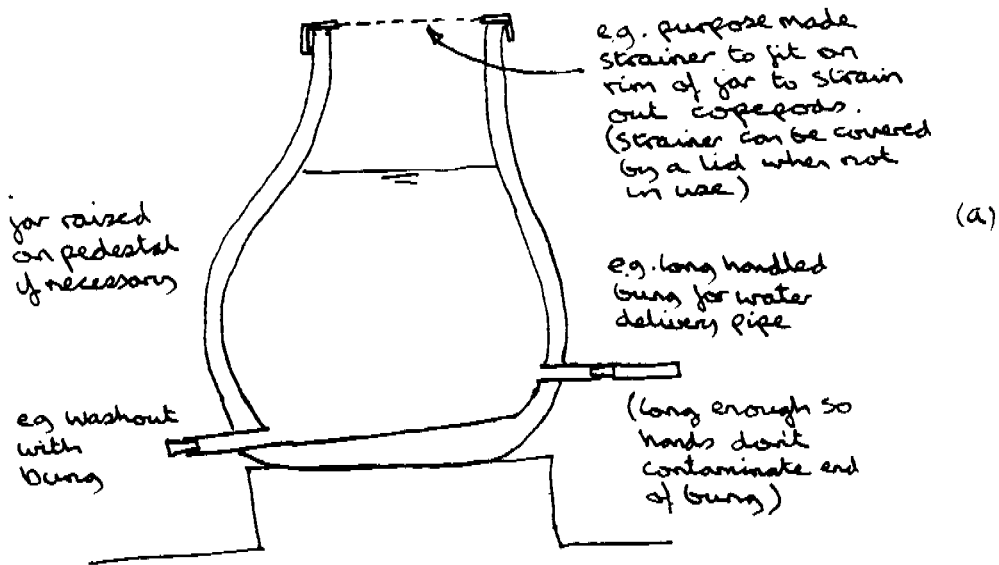

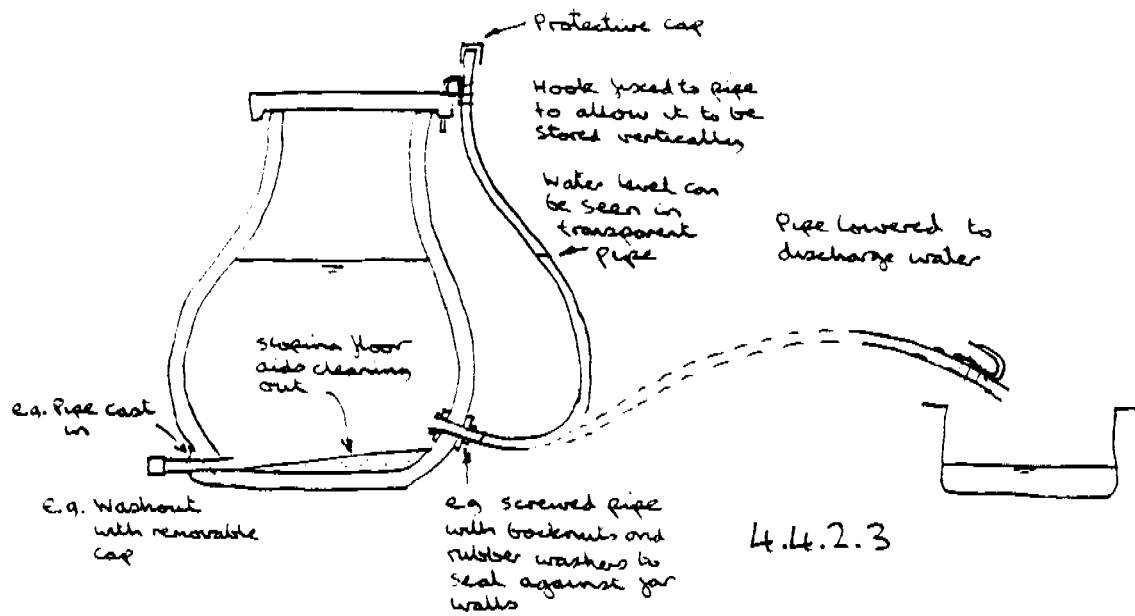

4.4.2.3

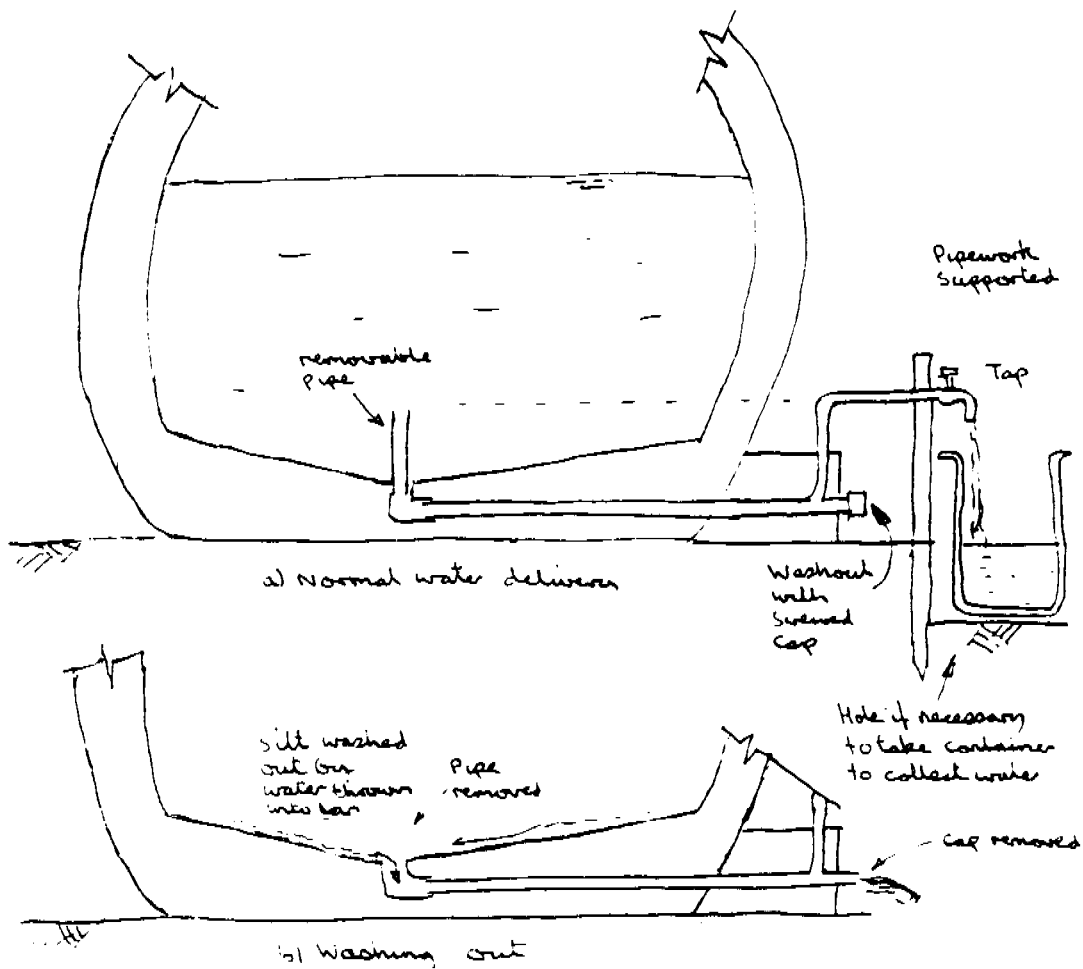

4.4.2.4

water withdrawal. A Kenyan design for a 46m³ tank cost about US\$1500 in 1991 (Gould, 1991).

Ferrocement can also be used very effectively for tanks which are below or partly below ground. For example there is one very cost effective large capacity design (over 75m³) consisting of a ferrocement lining to an excavated hemisphere which is widely used in Kenya (e.g. Nissen-Petersen & Lee, 1990a). This is sometimes provided with an arched ferrocement roof. These tanks are discussed further in Section 5.7.2. Such below ground storage requires the use of a handpump or the very careful use of a rope and bucket system for the withdrawal of water if its good quality is to be maintained.

It is suggested that the use of ferrocement tanks on a wide scale for rainwater storage in most Guinea worm endemic areas will probably not be as cost effective and as easy to introduce as the use of cement mortar jars. Amongst other aspects, their feasibility will depend on the amount of water which needs to be stored and the cost of the reinforcing materials needed for the ferrocement.

Other tank materials

Although the mortar jars and ferrocement tanks appear to offer the best potential for cost effective water storage it is recommended that project designers check to see if this is the case for the circumstances in a particular country. The previously quoted reference (Skinner & Cotton, 1992) gives comparative schedules of materials for a number of designs and it contains some useful advice about the various other important factors which need to be considered when choosing a particular construction method.

Where suitable sands or reinforcing meshes are not readily available for mortar jars or ferrocement tanks, or in other special circumstances, it may be cost effective to use other construction materials. For example, barbed wire reinforced concrete is reported to be most suitable for Machakos District, Kenya, where stone aggregates are abundant (Gould, 1991 & 1992).

Instigating a rainwater catchment project

Where flat galvanised sheet and galvanised wires of the right gauge are already available in

a country it is likely that suspended 'V' gutters are the most cost effective guttering system. As mentioned above, cement mortar jars, or maybe ferrocement tanks are likely to be the cheapest method of storage. The costs of a rainwater catchment and storage system using such components needs to be calculated to see if it is likely to be affordable to users and how it compares to the cost of improving traditional sources or providing new sources of water.

Unfortunately in many situations the use of loans or subsidies will probably be necessary to make the system affordable (Gould, 1991). Gould also gives examples of the successful use of revolving funds in Kenya (quoting de Vrees, 1987) and loan/income generation schemes in the Philippines (quoting Appan et al. 1989) and in Indonesia. Before rejecting the idea of a subsidy it should be noted that many other rural water supply systems, such as boreholes equipped with handpumps, are also usually subsidised, so where a groundwater extraction system is not feasible it is not unreasonable to give a rainwater catchment system a similar per capita subsidy if without external assistance it cannot be afforded by potential users.

It should also be noted that maintenance costs of a rainwater catchment scheme are very low and are borne by individual households who have a vested interest in caring for their system.

If there are sufficient houses with sheeted or tiled roofs in a Guinea worm endemic area which has a suitable rainfall pattern and the idea appears to be feasible, then a small pilot project to demonstrate the system can be instigated with the participation of some interested members of the community. If the pilot scheme shows promise then a wider programme of investigating the community's views concerning rainwater catchment can be carried out, followed by health education and the promotion of rainwater catchment schemes. Where some form of rainwater catchment is already practised the adoption of a new project is likely to be more rapid.

The Rainwater Harvesting Information Network at the Water and Sanitation for Health Project (WASH) is a useful source of information on all aspects of rainwater harvesting. It can be used by project designers for finding information

about rainwater projects in any particular area of the world. The recently formed International Rainwater Catchment Systems Association (ICRCS) may also be helpful. The addresses for these organisations are:-

Rainwater Harvesting Information Centre,
c/o Dan Campbell,
Suite 1001,
WASH Project,
1611 North Kent Street,
Arlington,
VA22209,
U.S.A.

International Rainwater Catchment Systems
Association,
c/o John Gould,
Department of Environmental Science,
University of Botswana,
Post bag 00222,
Gaborone,
Botswana

5 COST EFFECTIVE IMPROVEMENTS TO SURFACE WATER AND UNPROTECTED GROUNDWATER SOURCES

SECTION SUMMARY

Surface water is usually of poor bacteriological quality and whenever possible an intervention which removes the risk of faecal pathogens as well as infected copepods should be used.

Interventions At The Source

Of the interventions which mainly address only the problem of copepods the most effective relate to the separation of people from the source.

- There is a need for physical barriers and the acceptance by everyone of a community rule that no one enters the water but that it is drawn only from a dedicated point.
- There are three preferred methods of drawing water at this 'dedicated' point, described in order of preference. The first comprises a sustainable handpump and floating intake. The handpump can either be directly connected to the floating intake or it can draw water from a well-like reservoir in one of the banks which receives water from the intake.
- Secondly the use of a shaduf or other bucket and rope method from a vertical abutment with a surface which drains away from the pond is recommended.
- A final option is the use of a hand held bucket dipped into the water from a platform or ramp close to the surface of the source.
- In order to give a good level of protection against copepods the three recommended options can be modified by the use of strainer material. Either the floating intake can be protected by a box of straining mesh, or, adjacent to the access platform, an open topped strainer box can be used. This box floats in the water with straining mesh on its sides and base so that water drawn from within the box when users dip their

buckets into it is automatically strained (Neither of these two suggestions are known to have been tried so they both need to be field tested to discover how effective and sustainable they are.)

- Where necessary and feasible chemical insecticide (Abate) can be used if its application is properly managed

Of the interventions which provide copepod free water of reasonable or good bacteriological quality, depending on the field conditions, the following methods are recommended.

- Convert stepwells to protected draw wells or to wells equipped with a handpump (if a sustainable handpump is available).
- Collect water which is naturally infiltrating near to water sources or collect water from man made infiltration systems.

Interventions After Water Has Been Collected

- The straining of water before consumption is recommended if other water treatment methods which remove most bacteria as well as copepods are not feasible. This straining is particularly appropriate where people need to consume water away from their usual protected source.
- Settlement, long term storage and straining using vessels in the home can lead to a greatly improved bacteriological quality to the water and this should be field tested. Cement mortar jars are suggested to be ideal containers and they could be sold with purpose made strainers, and taps or pipes for hygienic withdrawal of water.
- The use of locally available coagulants could be promoted to lead to an even better quality of water from the system just mentioned but this needs further study in the field.
- It is considered doubtful whether domestic or pondside slow sand filters can be properly sustained to produce water of good quality but their use would lead to some improvement in the quality of the water.

- Solar disinfection does work during periods of bright sunshine and in the absence of other methods of improving the bacteriological quality of the water it could be field tested to see how it works out in practice
- Chemical disinfection at a users home is not considered to be sustainable.

Other Points Regarding Surface Water

- Improvements to the ground level catchments areas which contribute to rain fed ponds will
- lead to a better quality of water in the pond. These improvements include fencing, interception and diversion of surface water from outside the catchment, settlement and the use of gravel filters.
- Where sustainable suction pumps are not available it may be possible to convert direct action and deepwell pumps to allow them to be used as offset pumps for drawing water from floating intakes or bed infiltration systems.
- Where man made infiltration systems are to be used in static water bodies, or where slow sand filtration systems are to be used, it is recommended that the feasibility of using one or more mats of open weave filtering fabric on the surface of the filter is investigated. This has the potential to simplify the cleaning process and can lead to improved lengths of filter run and a shorter 'ripening' period after filter cleaning.

Introduction

It was noted in Section 2 that surface water usually contains pathogenic micro-organisms originating from faeces and these need to be removed to remove the risk of disease transmission. Any method used to remove such pathogens will also effectively remove the much larger copepods which carry the Guinea worm larvae. The fact that the occurrence of copepods in surface water is also often related to the speed of flow of the water was also mentioned.

Unfortunately it is not very easy to produce potable water from polluted surface water. A number of possible technical systems are available but it is usually hard to sustain these in small communities in a low-income country. This problem increases as the size of the community decreases or as it becomes more dispersed.

Figure 1.3 in Section 1 shows the various points of intervention possible in the life cycle of *dracunculus medinensis* and each of the three points of intervention are considered in the following sections.

This section investigates some simple methods of preventing the copepods in surface water or unprotected groundwater sources from becoming infected with Guinea worm larvae. In addition to these interventions at the source, it should be noted that the medical interventions of bandaging a lesion, or using surgery to remove a Guinea worm before the expulsion of any larvae, are also effective in preventing larvae reaching copepods (Akhter, 1992).

Methods of killing or removing infected copepods from water used for drinking purposes are then considered. Unfortunately most of the sustainable methods of intervention in these three categories do not usually lead to much of a reduction in the risks associated with faecal pathogens in the water. Interventions which in addition to removing the risk of the transmission of dracunculiasis also remove, or considerably reduce, the risk of the transmission of diseases carried by faecal pathogens are therefore investigated. It is hoped that such methods of producing potable water, although often more expensive than those dealing only with copepods, will be used wherever possible to lead to a reduction in diarrhoeal diseases as well as the elimination of dracunculiasis.

Considering ways of improving the existing sources of water used by a community is a good starting point in any programme since these sources are already acceptable to users and are considered by them to be the most convenient source. If a project is promoting the use of a better quality, but less convenient source the community will have to be fully convinced of the advantages of the new source before they abandon their existing one. To achieve the

necessary changes of attitude and practice usually takes a long time. With appropriate health education it may be possible to promote an improved source just for drinking water and to allow water for other uses to be drawn from existing sources. If possible, this has the advantage of reducing the amount of water needing purification which can reduce costs and maintenance problems.

With all the methods discussed in the following section it should be remembered that people who move out of their villages for any reason, and thereby away from any improved water sources, are at risk of catching diseases from any unprotected sources they then use away from home. The reader is also reminded about the discussion in Section 2.2 which stresses that the adoption of hygienic handling and storage practices are necessary to maintain the quality of the water from any protected source until it is consumed.

5.1 Barriers To Prevent Copepods Being Infected With Guinea Worm Larvae

5.1.1 Community rules on access

One of the simplest ways of preventing Guinea worm larvae entering the water is to make sure that no people infected with Guinea worm come into contact with the water. However this idea will only work if the whole community understand and accepts the importance of everyone following the rule and care needs to be taken that visitors to the community do not break the rules. In addition people need to be willing to draw water for those who are suffering from dracunculiasis. Some reports from Ghana suggest that where such improved water drawing practices are used they make a major contribution to the reduction in transmission of Guinea worm disease (Bugri, 1992).

The risks of contamination of the source by Guinea worm larvae arise not just from people who come to draw water but for example also from people who come to bathe in the water or children who come to play in the water. Faecal contamination arises not just from people entering the water but from the washing of clothes, the entry of animals into the water and from polluted surface water that flows into the

pond. This entry should be prevented as much as is possible by raising the edges of any pond or tank to divert surface flow away. If such flow is required to fill the pond then other precautions are needed and these are discussed in Section 5.6.

There are two approaches to restricting access to open water sources. The first is to only let uninfected people enter the water and the second is to provide barriers to prevent everyone entering.

5.1.2 Access only for the uninfected

The practice of people entering a body of water to collect water is very detrimental to the general quality of the water. Although people without dracunculiasis lesions can not add larvae to the water anyone who enters the water is likely to add some faecal contaminants to the water every time they collect it. Such contamination contains numerous pathogens which can cause a number of illnesses in those who drink the water untreated. Despite this drawback restricting access to only those uninfected with Guinea worm is a possible start point in the fight against dracunculiasis where a community accepts the idea.

Where schistosomiasis (bilharzia) is endemic in an area there is a danger of the source having infected snails and anyone who enters the water is at risk of being infected with cercaria which may burrow into their skin (see Section 2.2.2).

5.2 Barriers to prevent anyone entering the water

Preventing everybody entering the water is much preferable to the restricted access just described. Such barriers will prevent water drawers from continually introducing contaminants, although during the rainy season contaminants will often also be washed from the surrounding ground into any unprotected open source. Various methods can be used to avoid or prevent the need for water drawers to enter open water sources and a number of these will now be considered.

Fences

(Of value for ponds and tanks, unless fences are very dense or made from thorns people, espe-

cially children, will often find a gap through which they can pass. If people choose to they will of course also make gaps unless the community metes out some sort of punishment to offenders. However, even very simple fences are a reminder to the community, or visitors, that they should not enter the water and when someone is observed inside the fence it is clear that they are breaking the community rule.

Because a fence restricts access to the water it needs to be used with some appropriate method of drawing water which can be operated from outside the fence and a number of water lifting devices are considered later in this section. Alternatively there needs to be a gap in the fence through which people gain access to a platform near to the surface of the water so that they can reach down and immerse their container to draw the water. Whatever method of drawing water is used it will usually need to make allowance for changes in the water level during the year.

Fences are also useful for preventing the access of livestock. Where livestock are traditionally allowed to enter the same water source as that used for drinking water the practice should be discouraged. Such animals not only bring contaminants into the water but they often stir up a lot of mud which makes subsequent treatment more difficult. Where there are a number of open sources it may be possible for the community to agree to dedicate some of the ponds just to livestock and to use fences to prevent them from using the ponds chosen for water for domestic purposes. Alternatively water lifting devices can be used to draw water for the livestock and/or they can drink any water spilt by users if it is channelled away from the pond to a suitable drinking trough. A new pond could also be dug with its use dedicated to livestock. In a similar way, a pond could be dedicated to bathing and/or washing clothes.

Platforms

Platforms near to the surface of the water from which people can reach down to draw water in a hand held container can avoid the need for people to enter the water. However, certain types of fixed platform may be unsuitable if during the year the water level of the source varies by a large amount.

For sources without steep sides it may be possible to construct a ramp, raised at least 750mm above the sloping base of the pond, to give access to the water. Whatever the pond level, it will then be possible for someone to walk down the ramp to near where it reaches the water and then they can draw water over the side of the ramp. Wide steps can be used in a similar manner.

For sources with steeper sides it may be possible to construct an overhanging platform, or vertically walled abutment from which users can draw water using a bucket and rope. Some additional excavation will usually be necessary near to the platform to make sure that water is accessible from such a structure at low water levels. The advantage of the use of an abutment or solid platform is that it can be constructed to slope away from the water source so that contaminated spilt water can be drained away from the source.

Another option is to use a ramp spanning from the bank to a floating platform from which the water can be easily collected whatever the water level. A variety of materials can provide buoyancy. Empty 200 litre oil drums could be used as floats, possibly coated with a protective layer of ferrocement to prevent them becoming holed due to corrosion. One disadvantage of the use of ramps, steps and walkways down to the water is that users' feet can deposit contaminants such as faecal pathogens on the access and these can be easily washed into the water by rain. Open slatted timber walkways will also allow dirt from feet to fall directly into the water. Also spilt water which comes into contact with Guinea worm lesions can drain back into the water. In this respect the abutment type of collection point described above is better than the other types of access.

Upgrading of stepwells

Some communities make excavations near to rivers, or in dry river beds and they go down into these excavation to draw water. Such 'stepwells' are often points of transmission of dracunculiasis and diseases carried by faecal organisms but there is usually potential for upgrading the collection point to remove or minimise the risk of disease transmission. Often this can be accomplished by converting the stepwell to a draw well (Figure 3.3.1.2). Good

Cross-section of completed concreted ring lined 'Upgraded well'.

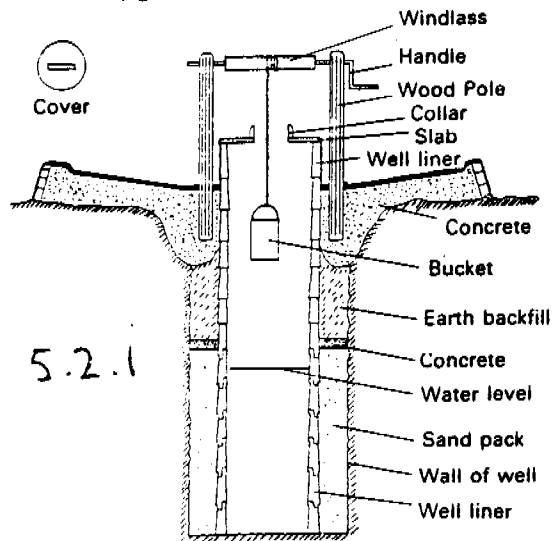

Note: There is some variation in the backfill. This can successfully be made with the cuttings from the well itself or with well-washed river sand. Soil from the surface should not be used for the lower backfill. Soil can be used nearer the surface.

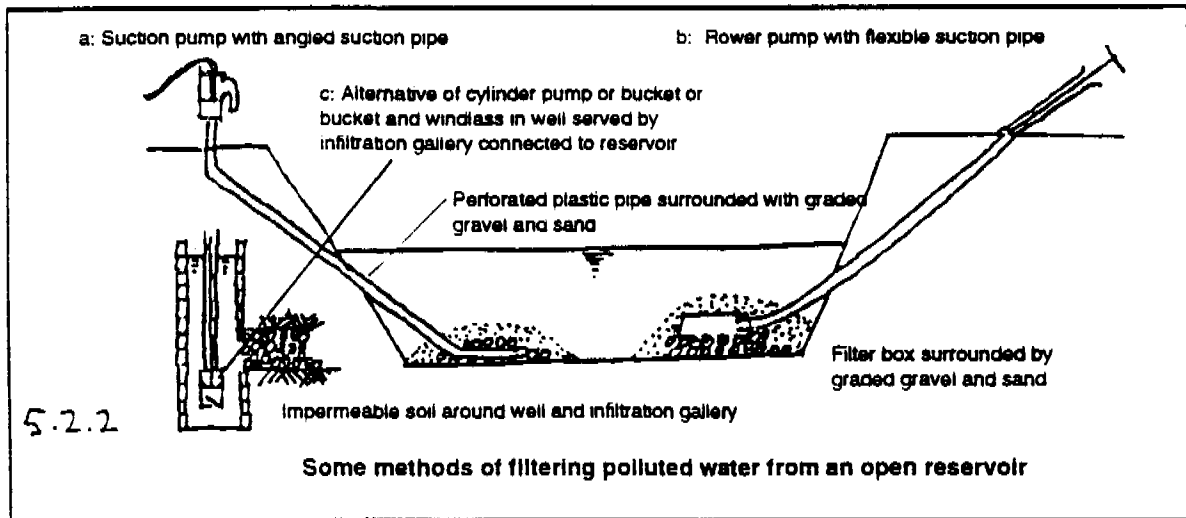

design features of converted stepwells are identical to those for draw wells (see Section 3.3.1 and 3.3.3).

Riverside excavations above flood level can often be converted to draw wells by providing a lined shaft and backfilling the excavation taking care to provide a sanitary seal around the shaft near to the surface to prevent contaminated spill water or surface water finding an easy path to the groundwater (Figure 5.2.1).

Seasonal excavations in river beds can also be converted to draw wells but since the site is under water during the wet season the structure may be subject to loads from fast flowing water and flood debris. Also the bed of the river may fluidise undermining and destabilising the structure. These factors make the construction of permanent river bed wells which can be used seasonally rather difficult and it is preferable to have wells in the riverbank, with infiltration galleries if necessary passing into the river bed. Such river bank wells have the advantage of making water available all the year round.

If the river bed well is likely to be undamaged by flood waters then one can be constructed. If it is left open then the debris deposited in it can be dug out by the community at the end of the wet season, just as traditionally they would have dug a stepwell every year, but these wells are likely to be polluted when first used after re-excavation. Also it will be difficult for the community to excavate very far below the initial high water table without the aid of a powered pump and it may be necessary for the well to be deepened several times as the water level below the river bed falls. One further problem that can occur is that the debris below the water in the well may limit the entry of water through the perforated sections of lining.

It is preferable to build a lined well in a river bed only if it is provided with a strong access cover which can be closed during the flood season in order to prevent the entry of most of the silt and other debris. Such a well can only be used as a draw well seasonally when the cover is removed.

One further possibility is to have a totally buried well in the river bed from which water is

withdrawn using a pump. This option is discussed later.

Water lifting devices

The use of a water lifting device will make it unnecessary for the user to come very close to the water and if the collection point is well designed there is no risk of a user contaminating the source with Guinea worm larvae.

Methods of collecting water from open bodies of surface water can be similar to the rope and bucket methods used for hand dug wells which were discussed earlier (Section 3.3.3). Usually the height of lift is quite small and a simple 'shaduf' will be appropriate.

Suction handpumps are usually very suitable for drawing water from surface water sources. Since they can be set back a little distance away from the edge of the water source the risks of users contaminating the source in any way is very unlikely. The suction pumps rising main contains no operating rods so it can be laid horizontally from below the pump and then down the bank and into the water body (Figure 5.2.2). A continuous flexible pipe make ideal suction pipes since, unlike stiff pipe systems, there will only be need for one joint and this reduces the potential for air to enter the pipe at joints and spoil the pumps performance. Flexible pipes also have the advantage that they can be used in conjunction with a floating intake as mentioned below.

There are some handpumps which are considered acceptable for irrigation but not for groundwater. They have usually not been considered suitable for drinking water because there is some risk of water being polluted as it is collected at the pump. Because the amount of extra pollution is likely to be small compared to the likely existing pollution in a surface water source it is suggested that the use of such pumps should be allowed if there are no feasible alternatives. They are considered useful because they keep users away from the source and hence protect it from contamination.

One simple design of suction handpump which can be used with surface water sources is the 'Rower' pump (Figure 5.2.3). This easily maintained pump was first manufactured in Bangladesh where its main use is as an

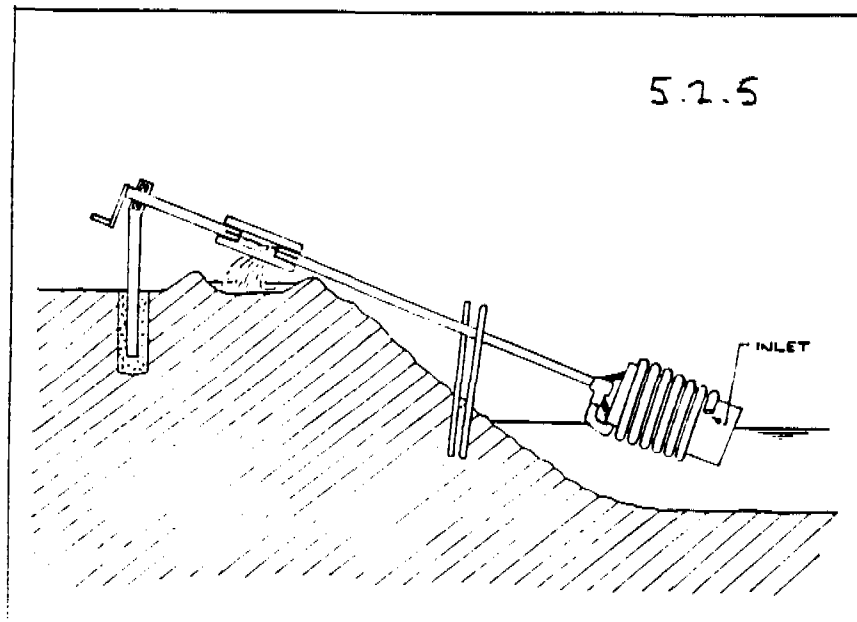
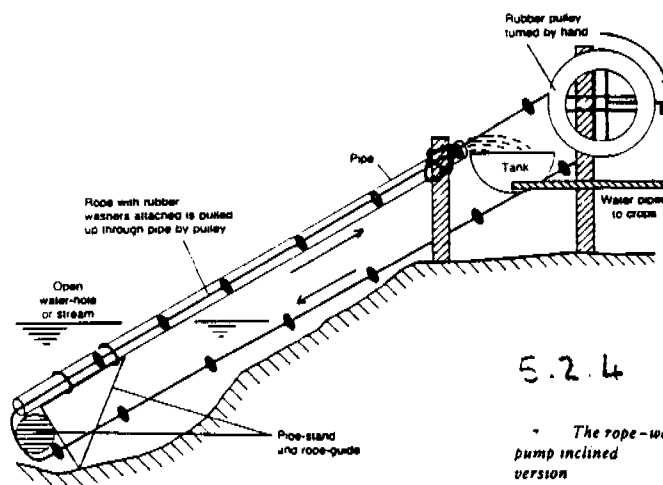
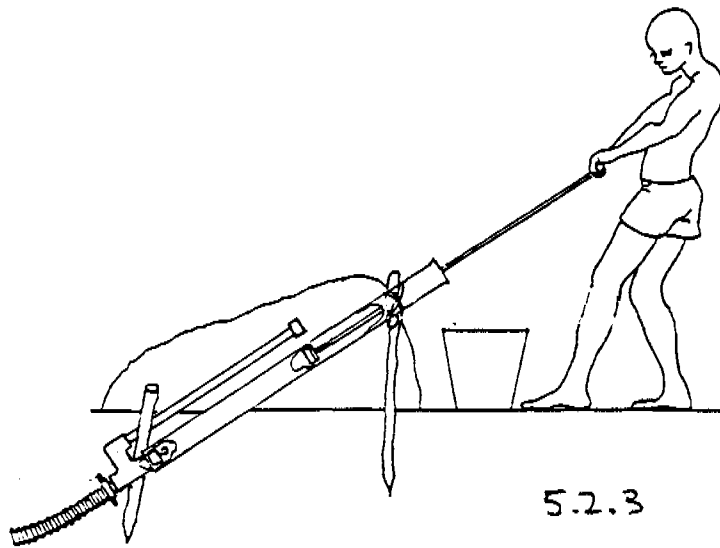

irrigation pump. A derivative called the SWS Rower Pump is now being manufactured in the UK where it is being sold for export at a cost of about £135. When using a Rower pump for water supply a water container is placed below the open end of the sloping 2" or 2.5" diameter plastic pipe which acts as a cylinder. The piston is operated using a rowing action with two hands gripping the "T" bar handle connected to the piston rod and this lifts the water which flows out of the open end. Wastage of water can be high if users are not careful since some water can overshoot the container, but the SWS pump has some attachments which can be used to minimise this. These also solve another problem which is that users can sometimes be sprayed with water at the start of the downstroke. The angled pump body simplifies the routing of a pipe to the water source (Figure 5.2.2). The long pump stroke possible when used by adults leads to a very fast delivery rate which is appreciated by users. The open ended cylinder has been criticised as being prone to contamination and to the theft of the pump handle, rod and piston assembly but in many situations these disadvantages may be outweighed by the advantages. Some communities overcome the theft problem by removing the handle at night and they also cover the open cylinder pipe with a tin to prevent the entry of contaminants. As with all suction pumps the loss of prime can be a problem, but the maintenance or replacement of the foot valve on this pump is very easy.

Another pump which can usually be locally produced and maintained using commonly available materials is the rope and washer pump (Lambert, 1989). It can be used in an inclined position for open water bodies (Figure 5.2.4) or in a vertical position for hand dug wells but in the latter case other more hygienic pumps are preferable to maintain the good quality of groundwater. Like the Rower pump this pump is more commonly used for irrigation. The inclined version draws water from near the bottom of a pond so cannot benefit from the advantages of a floating intake which are discussed below. The vertical version could be used in a bankside 'well' fed by a floating intake in an adjacent water body (similar to what is shown in Figure 5.2.7a). Complete rope and washer pumps are locally manufactured and sold in Zimbabwe for less than £60 (Lambert, 1992).

A third simple pump which could also be locally produced in some countries is the inclined coil pump (Figure 5.2.5). Its floating drum makes it suitable for a varying water level. It is not reported that this has ever been used to draw water for domestic purposes. Due to the depth of the drum in the water use of this pump does not gain the benefit of shallow floating intakes which are discussed below.

Direct action handpumps are less suitable than suction pumps for water collection because the former usually need to be mounted directly above the source and they are therefore more suitable for a bank well. However, where such a well is not thought to be appropriate, and if it is considered that a direct action pump is the best pump then it can still be used as long as it is of the type which allows the footvalve to be withdrawn through the rising main. The arrangement would have to be similar to that shown in Figure 5.2.6 where one end of a suction pipe or hose is connected to a bend at the base of the rising main and the other end enters the pond.

Deepwell handpumps are overdesigned for the shallow lifts encountered with most surface water sources but open topped cylinder deepwell pumps could be used in a similar manner to that just described for the direct action pump if no cheaper pump were available.

Floating intakes

As mentioned in Section 1, one of the characteristics of copepods containing the infective third stage of the Guinea worm larvae is that they become sluggish and sink towards the bottom of a water source (Muller, 1985). This indicates that unless effective pond bed filters are used to prevent copepods being sucked into the pipe, the intake should be positioned near to the surface of a water body rather than near to the base. Such a position is also advantageous if turbid surface water can flow into the pond during heavy rain because water near the surface will be the first to become clear as the suspended solids settle down to the bottom of the pond. It is also advantageous because if the water is stationary some bacteria in the clear water near to the surface of a reservoir will be killed off by the ultra violet component of strong sunlight (Section 5.9.3).

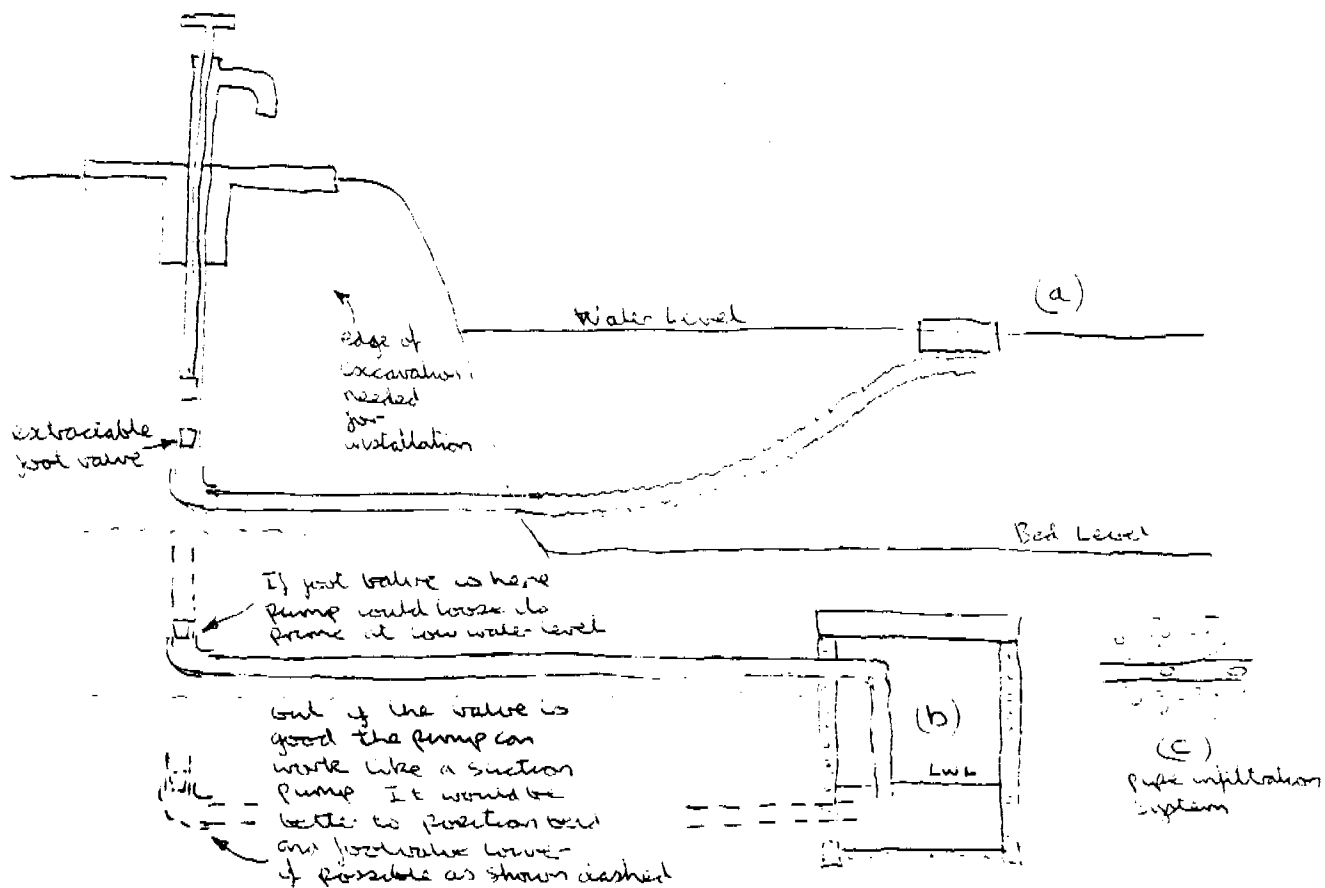

Suggested method of converting a direct action pump to allow the collection of water from a floating intake or over bed infiltration system (such as the buried well shown). This could also be used with an open top cylinder deepwell pump with an extractable foot valve.

5.2.6

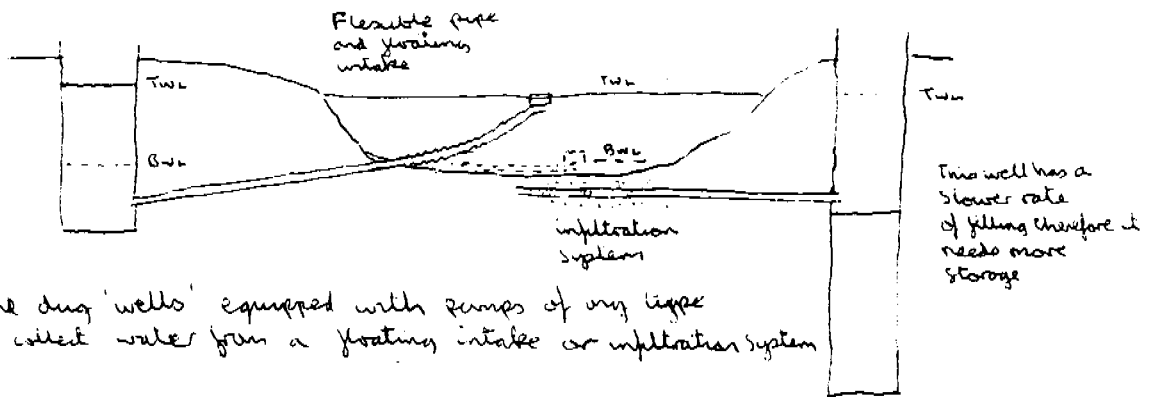

2) Hand dug 'wells' equipped with pumps of any type to collect water from a floating intake or infiltration system

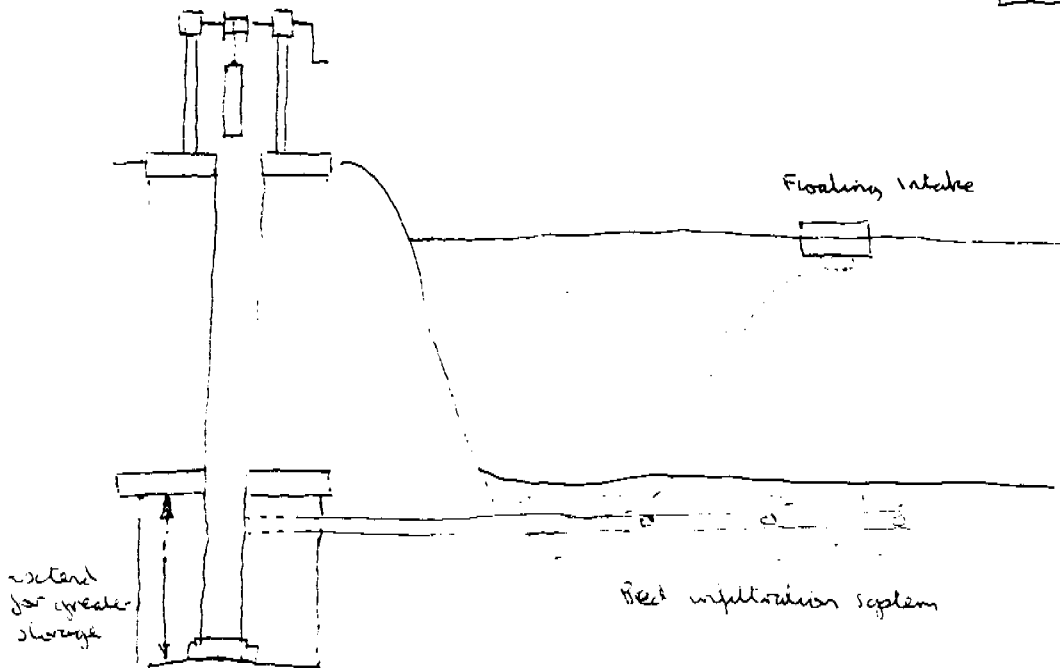

3) Blar bucket pump in backfilled well used with a floating intake (with the floating intake the lined well section could be omitted and pipe to float could be directly connected to the casing) or infiltration system

5.2.7

However, the extent of this effect has not been quantified in field studies.

Where the water level in the source fluctuates during a year a floating intake is ideal for withdrawing untreated water from surface water sources. Such an intake can be surrounded with a strainer to ensure the exclusion of all copepods as discussed in a Section 5.3.2.

Numerous designs of floating intake are possible (Figure 5.2.8). One interesting design described by Morgan (1990) is to make a closed ring of polyethylene pipe to act as a float and then to wire to this another ring fitted to a tee piece connected to an outlet pipe. This second ring has a series of 10mm diameter holes drilled in the underside of the ring to admit the water and a few 5mm holes in its upper surface to allow any air to escape when the ring is filling with water. The outlet pipe to any floating intake can be the suction pipe to a pump (Figure 5.2.6a) or the gravity feed to a bank-side 'well' reservoir (Figure 5.2.7).

5.3 Killing Copepods and Straining Out Copepods from Unprotected Water

Where it is not possible to prevent all copepods in a source from becoming infected with Guinea worm larvae then they need to be eliminated from drinking water to make sure that the spread of dracunculiasis is halted. There are two common approaches to their elimination, one is to use chemicals to kill the copepods in the water and the other approach is to strain the live copepods out of the source water before it is consumed.

5.3.1 Killing Copepods

There are two places where the copepods can be killed either in the source water or in the water after it has been collected.

Killing copepods in the source water

Using chemicals

The commonest method of killing copepods in static open water sources is through the use of chemicals applied in concentrations which kill the copepods but which are harmless to humans who may consume the treated water. Temephos (Abate) is now the chemical most widely used

for control although chlorine and iodine have sometimes been used. 'Guidelines for Chemical Control of Copepod Populations in Dracunculiasis Eradication Programmes' (CDC, 1989) is the standard reference on the subject and it recommends that only Temephos is used. It suggests that chemical control of copepods should be considered when the following conditions apply:

when there are few sources, each less than 500m³ in capacity, which are being used by many people;

where the provision of safe drinking water from other protected sources is not feasible;

where health education compliance is poor;

during outbreaks of dracunculiasis while villagers wait for the provision of permanent protected sources of drinking water;

when an additional security measure is needed to prevent transmission in areas where elimination is imminent or recently achieved.

Detailed advice on deciding which sources to treat, and when and how to apply temephos is also given in the quoted document.

Timing is particularly critical, the first application needing to be made at least one month before the expected appearance of lesions on infected people and applications needing to be repeated every 4 to 6 weeks throughout the transmission season.

In order to apply enough temephos to achieve the recommended dose of 1 mg/l it is necessary for the correct volume of the pond to be established for each of the varying water levels that will be encountered during the treatment season. Temephos kills both the copepods and the Guinea worm larvae (UNICEF, 1992).

The American Cyanamid Company is willing to donate Abate to approved projects which follow the correct procedures for requesting it through Global 2000 and UNICEF but projects must bear the shipping costs. Details of this scheme are found in 'Strategies and Resources' (UNICEF, 1992).

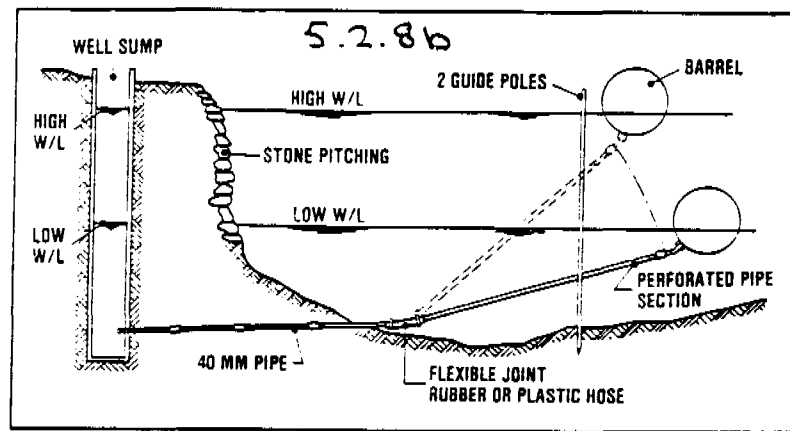
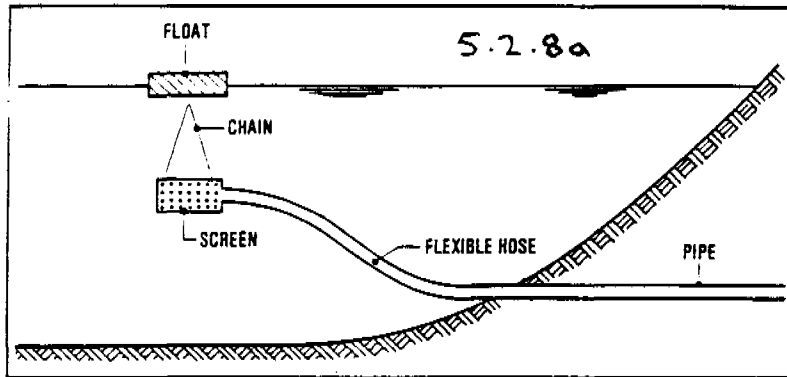

Although chemical control may appear simple, a high level of training is needed in to ensure the safe and effective use of the product and in the basic survey methods needed to accurately calculate the volume of any water bodies to be treated. Proper storage, planning, monitoring and logistics are also necessary for a successful programme so that the space between applications is not long enough to allow infected copepods to transmit dracunculiasis. Some communities may not readily accept the addition of chemicals to their drinking water, particularly if they note changes in colour, odour or taste.

Using fish

If a pond contains sufficient water all the year round to allow copepod-eating fish to thrive in the water then the fish will obviously help to keep down the numbers of copepods. During the preparation of this report no references were found to indicate how effective the use of fish can be in controlling the numbers of copepods in a pond. It is reported as having been promoted alongside the conversion of stepwells to draw wells in the SWATCH guinea worm eradication programme in India (Akhter, 1990).

Killing copepods after the collection of water

Copepods and the larvae they contain can be killed after a user has drawn water from a source but before the water is drunk. There are two main methods of accomplishing this, one is to use chemicals and the other is to boil the water.

Using chemicals

Temephos is not promoted for domestic treatment of copepod infected water. Instead, if anything, the use of chlorine compounds or iodine are usually suggested. Use of either of these chemicals has the advantage of also killing off a number of other potential pathogens but for good results the water needs to be free of suspended solids and organic material.

Chlorine compounds are usually more readily available than iodine, particularly in the form of bleach such as 'Jik' or 'Javel'. A concentration of 2mg/litre of free chlorine residual is required to kill cyclops (Muller, 1985) and application of a high concentration would be necessary to achieve this level of residual chlorine in water containing organic substances. The free residual concentration required just to ensure the

elimination of pathogenic bacteria is about 0.3mg/litre, much less than for killing copepods, but to achieve this even in clean water requires an application of about 2mg/litre (Cairncross & Feachem, 1983). A free residual level of 2mg/litre is required to kill off amoebic cysts (cit. ibid.) which are more resistant to chlorine than are the bacteria.

Bleaching powders are available in some countries but are liable to loose much of their chlorine before use unless very carefully stored. In the preparation of this report no references were found to the necessary application rate of iodine to kill copepods. To achieve disinfection from other pathogens application rates of 10-15 mg/litre are required. One of the factors against its use is the fact that it is highly volatile in aqueous solution (Hofkes et al. 1983) and there are some fears about unpleasant side effects from long term use (Cairncross & Feachem, 1986).

In addition to the problems of rural households being able to purchase, properly store and apply them in the correct concentrations, it is often found that the taste and smell of such chemicals, particularly free chlorine, is objectionable to most users (Muller, 1985).

Boiling

Boiling effectively kills copepods and the larvae they contain and it is also effective in killing other pathogens including bacteria, viruses, cysts and ova. Unlike the use of chemicals it is effective in water containing suspended solids. However it is expensive in firewood, requiring about 1kg of wood to boil each litre and with the increasing deforestation in many developing countries the adoption of this method of copepod control has been rather limited. Some people do not like the taste of boiled water.

5.3.2 Straining Out The Copepods

The minimum size of an infected copepod is about 0.5mm (Larsson, 1992) so passing water through a strainer with an aperture size smaller than this is an effective way of removing them from drinking water. Such methods of control are often referred to in the literature as 'filtration' or 'the use of filters' but since such terms can be confused with slow sand filtration, which is quite different in that it also removes

other pathogens such as bacteria, it is suggested that the terms 'straining' and 'strainers' are used instead. This terminology has been adopted throughout this report.

The straining material can consist of a finely woven cloth but nylon or polyester monofilament mesh is much better since it can be cleaned more easily after use. The E.I. DuPont de Nemours Company and Precision Fabrics Group have pledged the free supply and shipping of a suitable 30 denier nylon monofilament straining mesh with a pore size of 0.1mm to approved programmes which follow the correct procedures for requesting it through Global 2000 (UNICEF, 1992).

The use of a locally available tightly woven cloth, or the use of a double layer of more loosely woven cloth, is being promoted by a number of projects but people can grow impatient with the time it takes for water to pass through such strainers cloths especially as they often soon clog up and are hard to clean.

It is important that water passes through a strainer in one direction unless it can be thoroughly cleaned. This is because after one use live copepods, or dead copepods containing live larvae, may be trapped on what was the upper surface of the material and if it is then inverted they may be washed into the water container collecting strained water. A lasting distinctive mark on one side of the strainer helps ensure correct use.

It is worth emphasising here that straining through such a mesh or cloth does very little if anything to improve the bacteriological quality of the water, and although it is copepod free the water from a surface water source will still harbour many other pathogens after filtration.

It is clear that for strainers to be effective in the fight against dracunculiasis extensive appropriate health education is needed to change peoples attitudes so that everyone realises the importance of drinking only copepod free water. Such changes in attitudes are not easily achieved.

To date straining has usually been promoted as an intervention to be used at home or in the fields after water has been collected from a

source but it also possible in some instances for water to be strained as it is collected from the source.

Straining at the source

Nothing has been noted in the literature about the use of strainers at the source of infected water and this is one area of intervention which warrants further consideration. It is not really necessary to strain all the water taken home for domestic use but the users need to be fully aware of the risks of dracunculiasis before they are likely to be able to separate effectively water drawn through a strainer from water drawn without the use of a strainer.

Where people draw water from a source by immersing their containers in the water, if a dedicated water drawing point is chosen it may be possible to provide straining before the water is collected. This could be accomplished if an open 'box' of mesh, partly submerged in the water, is provided. Water drawn by users from the inside the 'box' will have been strained as it passes into the box through the sides and base. A floating box may be necessary where the water levels vary and the mesh on the sides and bottom of the box would always need to be enclosed in a strong grille to protect it from damage from the containers used to collect the water (Figure 5.3.2.1). The vertical mesh sides and horizontal base to the box would probably be self cleaning since any copepods or debris drawn onto the mesh when water enters the box to replace what is drawn out are likely soon to fall back into the water. Field tests of such an idea are recommended to ensure that it works in practice.

The provision of horizontal strainer systems near to the source, through which people pour their water after drawing it is not thought to be feasible. A major problem foreseen with such strainers is that they would need frequent cleaning to remove debris which would collect on top of the mesh. Such a system would also require two containers so one could be under the mesh while water was poured onto the mesh from the other.

A shallow sand filter box system which acts more like a strainer than a conventional slow sand filter has been proposed and tested by Sridhar et al. (1985). Although copepods were

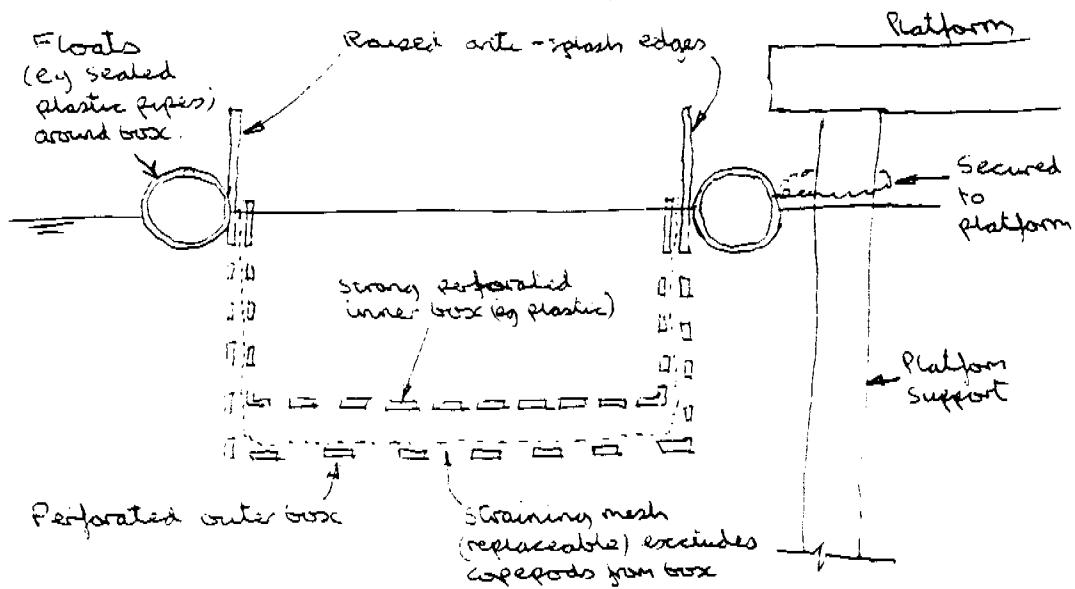

BOX DETAIL

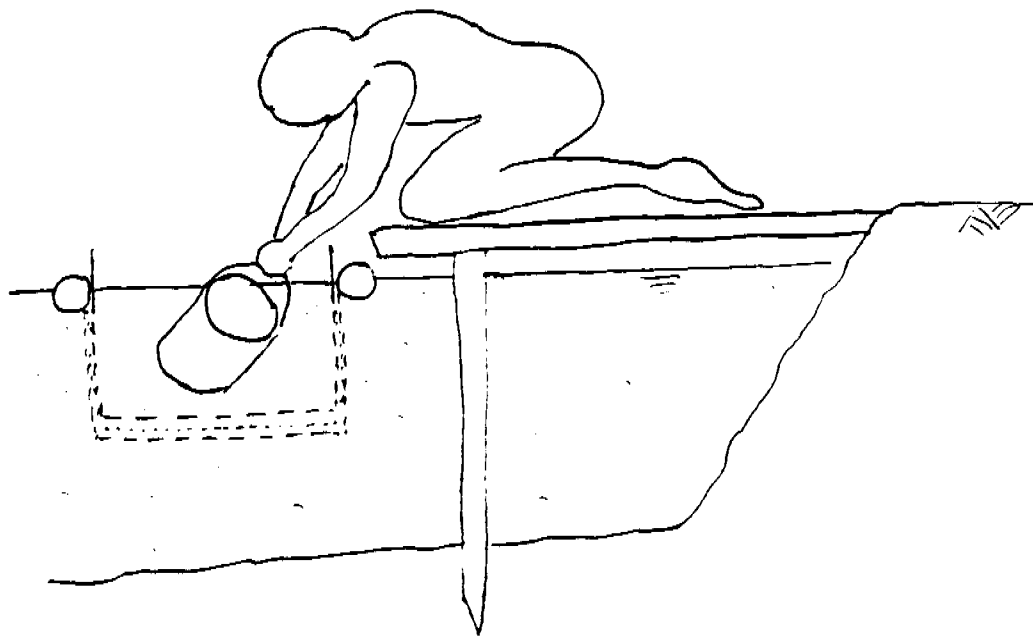

BOX IN USE

Sketches of an idea for a 'straining box' which allows people to collect copepod-free water

removed by this system it rapidly silted up. Even when it was clean it gave only a slow rate of delivery of water taking about 2 minutes for 25 litres.

One situation where straining at the source is most appropriate is where the user is away from a normal source of strained or protected water such as when working in a remote field. If such a person can not be persuaded to carry potable water to the field with them it may be possible to persuade them to carry at least a piece of straining mesh so that they can pre-strain the water they draw from a traditional unprotected source. Such a mesh could be tied over the end of any vessel used for drinking when it is immersed to draw water. Alternatively water collected in another container can be poured through the mesh as it is held over a second container used for drinking water. Both methods would ensure that the water in the cup or bowl is copepod free although of course it would probably contain other pathogens.

An interesting idea of distributing to farmers thousands of baseball caps made from straining material has recently been tried in Ghana according to de Rooy (1992) but the effectiveness of this approach has not yet been reported. The use of a stiff cap shaped strainer held partly in the water by one hand would presumably allow water to be scooped out of the centre by the other hand if no drinking utensil is available. It would also ensure that the copepods only came in contact with one side of the strainer (unless elsewhere water was poured through the cap from the inside!).

The use of floating intakes enclosed by a box of straining mesh is considered to have great potential for supplying copepod-free water where water is to be collected by any of the floating intake methods discussed at the end of Section 5.2.

Straining at home

The use of a strainer at home to strain all water collected from an unprotected source at first appears to be simple solution to the prevention of the transmission of Guinea worm disease. However as pointed out in 'Guidelines for Health Education and Community Mobilization in Dracunculiasis Eradication Programs' (CDC, 1991) the single behaviour of straining water is

more complex than it appears. There are several interrelated actions required, including:

buying or obtaining the strainer;

using the strainer the right way round for all drinking water;

removing the strainer carefully so that copepods will not spill into the strained water;

cleaning the strainer by backwashing it with strained water after use;

storing the strainer in a secure place where it will not be damaged;

inspecting the strainer before each use to be sure it has no holes or tears;

discarding a damaged strainer and replacing it.

According to local water gathering practices and available materials different strainer designs can make straining easier. Options cited by Silverfine et al. (1991) are:

using elastic (eg. strips of inner tube) around the edge so the strainer can be easily fitted over the mouth of a number of different sizes of container;

sewing strainer material to the centre of a piece of cloth to save expensive strainer material;

making a cylindrical frames of pliable bark with other cylindrical pieces nailed on the outside to hold the straining material in a form convenient for use (see also Duke 1984);

making small straining devices especially for farmers to carry with them for use in the field.

The hygienic storage of water in a home has already been discussed in Section 2 and the cost effectiveness of cement mortar storage jars was noted in Section 4. **It is suggested that Guinea worm eradication projects consider the production of purpose made strainers to be used in conjunction with suitably sized cement mortar water storage jars fitted with taps/hoses and dedicated for use only for strained drinking water.** As mentioned later

improvements to bacteriological quality can also be promoted using settlement and short term storage in such jars.

Unfortunately some individuals may use strainers for sieving corn and cassava starch or other uses which may damage them or prevent them being used for the intended purpose.

As previously noted to be sure of avoiding being infected with Guinea worm disease a person who strains drinking water when at home must also consume only strained drinking water when away from home or must only take drinking water from a protected source.

5.4 Infiltration Systems

One of the ways of considerably improving the quality of surface water is to collect it after it has infiltrated through granular material. As it passes through granular material the level of suspended solids in the water considerably reduces due to the removal of material by settlement, staining and adsorption. Under suitable conditions an active layer of micro-organisms which feed on bacteria can also develop leading to a considerable improvement in the bacteriological quality of the water. In fact a properly designed and maintained slow sand filter should produce an effluent free of all pathogenic bacteria, viruses and cysts.

There are two ways of ensuring that filtration of surface water takes place before it is collected:

by collecting it after it has passed through existing naturally deposited granular strata;

by collecting it after it has passed through granular material which has been especially carried to the site to facilitate filtration.

There is little difference between methods of water collection via naturally deposited strata and those methods of exploiting groundwater which have already been discussed in Section 3. The main difference is that the infiltration systems to be considered will be fairly close to the surface water source although the further they are away from the surface water source, generally the better will be the quality of the water (due to the longer period of flow from the

source to the extraction point during which bacteria will die off).

Both methods of exploiting surface water should always be explored in preference to direct collection of surface water because they provide water of a greatly improved bacteriological quality with few if any suspended solids. With all except the coarsest strata the process of filtration will also effectively remove any copepods present in the surface water. However, because infected copepods tend to become sluggish and therefore sink, they will collect on the surface of pond-bank or pond-bed filters so the design, construction and maintenance of such systems needs to be such that there is no danger of the infected copepods passing through the system.

Where infiltration systems are used in the beds of rivers or streams care needs to be taken to ensure that the collection systems will not be damaged by scour during flood flows.

The usual flow of water in perennial rivers is useful in that it will carry away any solids deposited on the bed or banks as the water infiltrated. This effect does not occur in ponds where over a period of time pond-bed or pond-bank infiltration systems are likely to become blocked by the solids which are filtered out of the water.

5.4.1 Filtration Through Existing Strata

Bank-side wells

If the soil and sub-strata next to a body of surface water are permeable then the groundwater level in them will be similar to the level of the surface water. This means that a well or borehole constructed adjacent to such a body of water will yield either groundwater which is approaching the surface water, or infiltrated water which has passed through the strata between the well and the surface water source. The further away the extraction point is from the source the better will be the quality of the water.

Infiltration wells and galleries

Many surface water infiltration systems can continue to yield water even after none is visible in the source because infiltrated surface water is often still present in the strata below the bed of

the pond or river and below the banks if they are permeable.

Where there is a long season when there is no water flowing in a river, if it has a deep bed of granular material it may be possible to draw water throughout the year from an 'infiltration gallery' connected to the bed deposits. These 'infiltration galleries' in their simplest form consist of trenches excavated into the water bearing strata which are backfilled with suitably graded fine aggregate and coarse sand to act as a conduit for the collected water to be transmitted to a collection point such as a bank-side 'well' from where the water can be extracted using a lifting device (Figure 5.4.1.1). A perforated pipe can be laid in the material filling the trench to considerably improve the rate at which the water can be collected from the surrounding strata (Figure 5.4.1.2).

The construction of such infiltration galleries in the beds of rivers can be quite difficult, and it usually has to take place in the dry season with the assistance of powered pumps and some form of temporary trench wall support. Where the banks are of a material which yields water infiltration galleries can be constructed along the bank (Figure 5.4.1.3) which can be easier than constructing one in the river.

With the right equipment it is possible to work from within a large diameter bank-side well to install horizontal perforated pipes into granular material in river banks or under river beds to collect the infiltrated water (Figure 5.4.1.4). Horizontally boring equipment developed by the British Geological Survey (BGS) for use in wells was mentioned in Section 3. Unfortunately it is expensive and it requires a well with a minimum internal diameter of 2m but the radials can often be installed relatively easily up to about 30 m in any direction to collect groundwater or infiltrated water over a large area. [Wright & Herbert (1985) and Herbert & Rastall (1991)].

The use of offset handpumps

It may also be possible to construct buried wells in the river bed from which water can be extracted using a handpump sited on the bank. Alternatively a suction pump can be directly connected to a suitable screening device buried

in the river bed and this is discussed in Section 5.5.

A recent use of a buried well system in seasonal streams in southern Ethiopia is described by Bradfield (1992). In this project 400mm diameter concrete rings, some of which had porous walls, were stacked vertically in a dewatered excavation in a sandy river bed. A pipe from the pump on the bank was routed into the space in the centre of the rings and the top of the stack was sealed some distance below bed level with a permanent concrete lid. The excavation was then backfilled with the river sand which also covered the lid.

These wells yielded 3000 litres per day and the material and labour costs came to £285 including £90 for the handpump. The pump used was a small rotary progressing cavity 'Mono M' pump from the UK, which Bradfield admits could be open to criticism since it is not strictly speaking a VLOM (village level operation and maintenance) pump. However because the handpump site was offset from the well it was not thought to have been possible to use either of the two VLOM handpumps available in the country, that is the direct action Nira AF85 and the deepwell 'Ibex' (a locally produced version of the Afridev). These pumps were also more expensive than the Mono M but the long term performance of the latter in the field is not yet clear although after a year there were reportedly no signs of wear.

Where a suction pump is not readily available, or where it is desirable to restrict the number of different types of handpumps in use in a country, there is a way of using direct action or deepwell handpumps as offset pumps to infiltration systems. This is in a similar manner to that described earlier for collecting unfiltered water from a water body. That is by fixing a bend and horizontal suction pipe below the footvalve of such pumps as illustrated in Figure 5.2.6b.

5.4.2 Groundwater dams

Groundwater dams are usually constructed across the valley of a seasonal river or stream which passes through an area of impermeable strata such as rock or clay. These dams obstruct the flow of groundwater in the bed of the

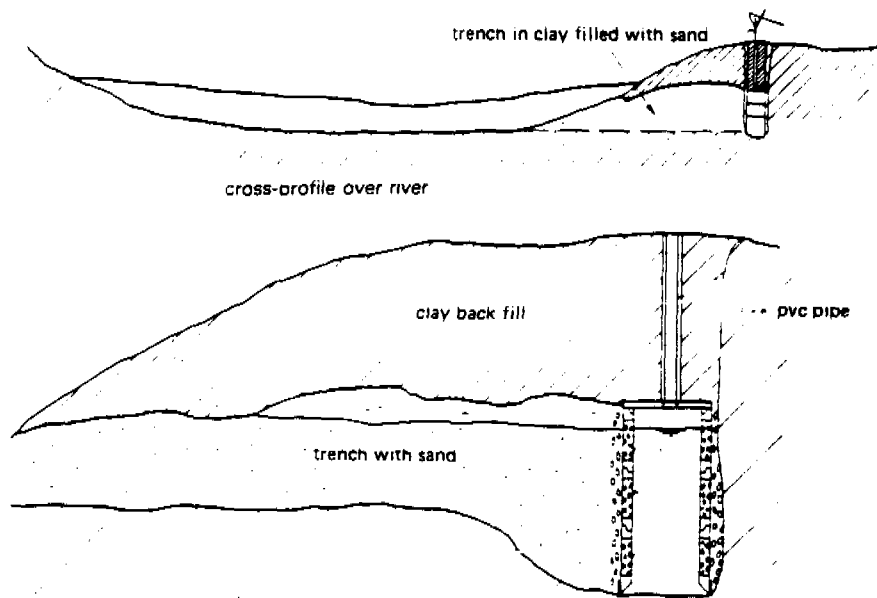

5.4.1.1

River well with sand trench to the bank

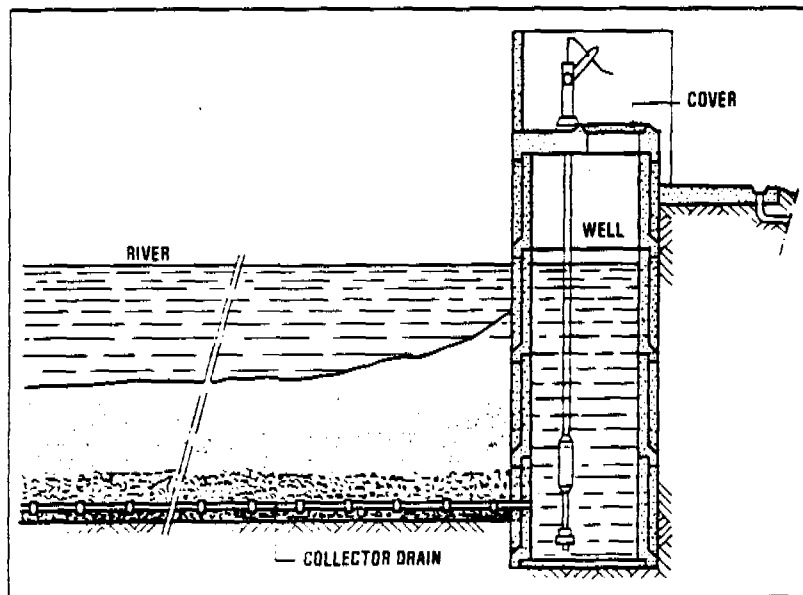

5.4.1.2

Figure Horizontal collector drain under river bed

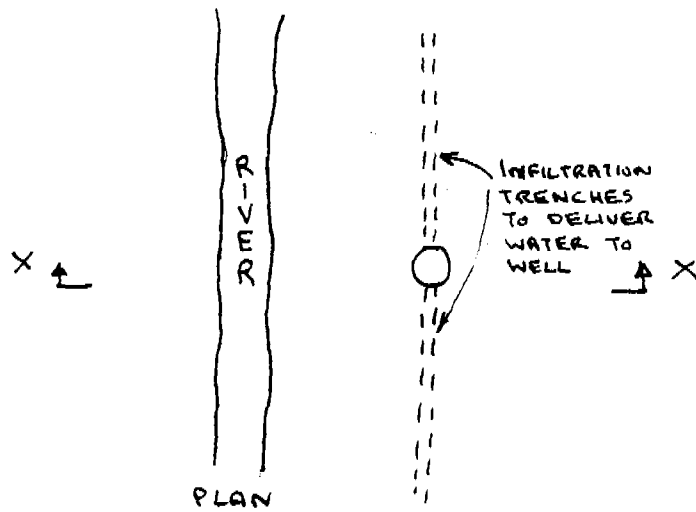

PLAN

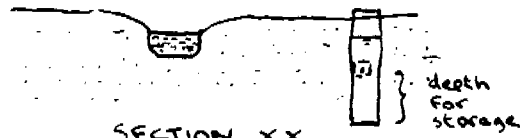

SECTION XX

5.4.1.3

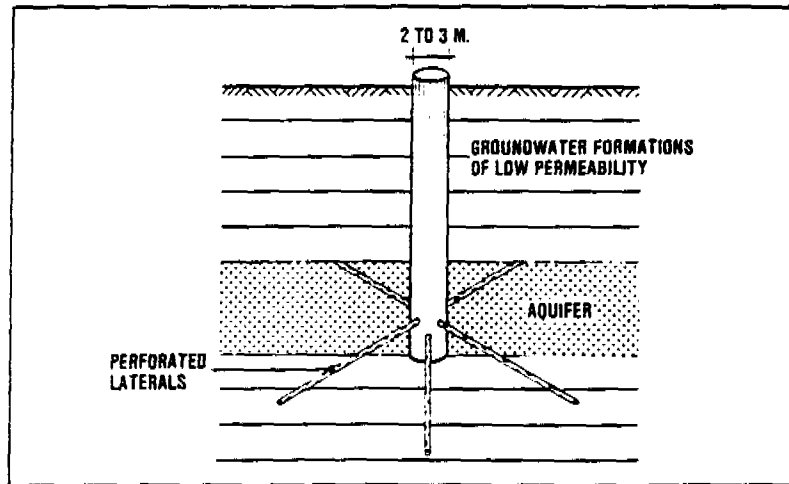

5.4.1.4

Figure
Radial collector well

watercourse in order to provide water storage below the surface.

There are two main types of groundwater dam:-
The *sub-surface dam* is constructed below the existing river bed to prevent the water contained in the river bed deposits from flowing downstream (Figure 5.4.2.1, 5.4.2.2 and 5.4.2.3). The *sand-storage dam* is extended above the original bed level to also impound water in sediments which accumulate behind the dam when floodwaters flow in the valley (Figure 5.4.2.4). More details of both types of dam are given below.

To date groundwater dams have not been very widely used but they have great potential for providing good quality water throughout the year from the river bed deposits found in some seasonal rivers. They can provide water in some situations where the use of just an infiltration gallery would not be successful.

Nilsson (1988) is recommended to readers who want to explore this technology further. A briefer introduction to the subject is given by Smith (1990) and Skinner and Cotton (1992). Detailed guidance on the construction of some designs of clay and stone masonry sub-surface dams is given by Nissen-Petersen & Lee (1990c).

Sub-surface dams

If water is not present in the bed material of a river throughout the dry season, it may be possible to construct a sub-surface dam to retain water which would otherwise flow downstream through the bed deposits. The dam which is constructed below the bed of the river can be built from a variety of materials including just clay (5.4.2.2a). Water in the bed material upstream of the dam is extracted by wells and/or infiltration galleries etc. In a few situations where the ground slopes sufficiently it may also be possible to use a pipe to deliver water by gravity to a downstream water collection point (Figure 5.4.2.5b).

Sand-storage dams

Sand-storage dams can only be sited where there is a seasonal flow of surface water which carries suitable granular material which can be deposited behind the dam to fill the planned volume of the reservoir. The choice of site and

the design of the dam is therefore rather more complicated than for the sub-surface dams mentioned above which rely only on existing granular deposits.

The dam is usually built in stages which are of a height suitable to allow the deposition of only the coarser materials carried in the seasonal surface water which flows over the dam. Because the dam is above the bed of the river it can usually be used in conjunction with a piped system which delivers water by gravity to a downstream water collection point (Figure 5.4.2.5).

The use of a sand-storage dam has at least two advantages when compared to a conventional surface water dam. The first is that the natural filtration of any polluted surface water through the sand will lead to a relatively good quality of water being collected from the lowest layers of sand. In the dry season this protective layer of sand also means that there is a greatly reduced risk of contamination of the stored water by users because it is not exposed. The second is that there are very low evaporation losses from the sand filled reservoir compared to an open reservoir, but of course a larger volume of 'reservoir' is needed to compensate for the volume of the sand.

Infiltration systems directly connected to suction pumps

Instead of collecting water from a river-bed infiltration system by using gravity flow to a below-ground reservoir such as a riverbank 'well' it is possible to couple a suction pump directly to a pipe connected to a suitable screening device buried in the river bed. Infiltrated water can then be pumped out of the device using a remote pump. Since most of these systems involve the construction of a filter of specially selected materials rather than the use of existing strata they are considered more fully below.

5.5 Infiltration Through Man-Made Filters

Two types of man-made filters are considered in this section. One type is constructed below ground and is useful where the bed or banks of a river or pond are impermeable or can only transmit water slowly. In such situations it is possible to construct an infiltration system by

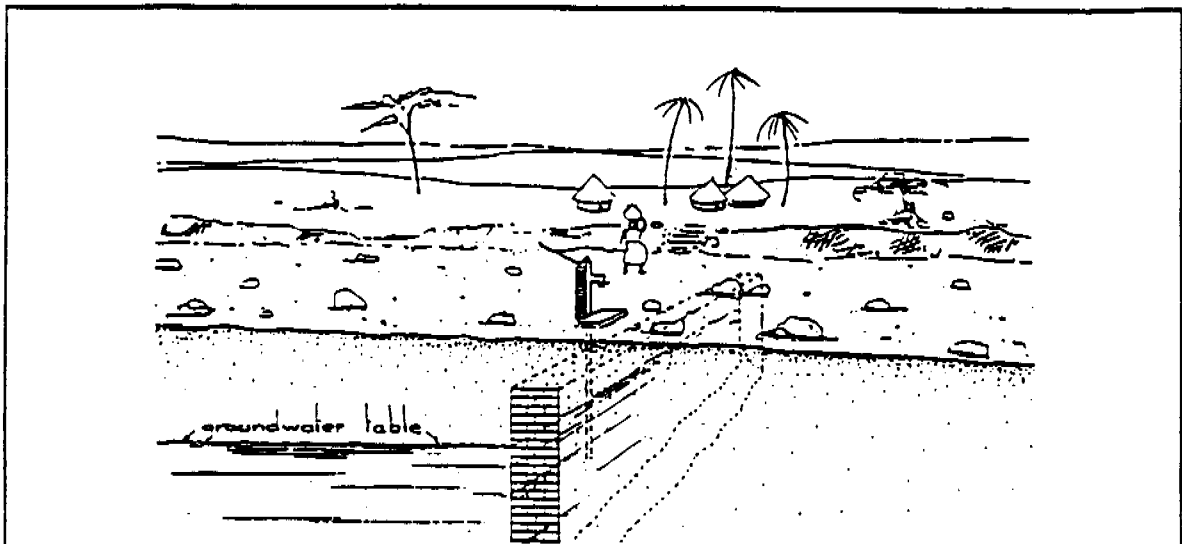
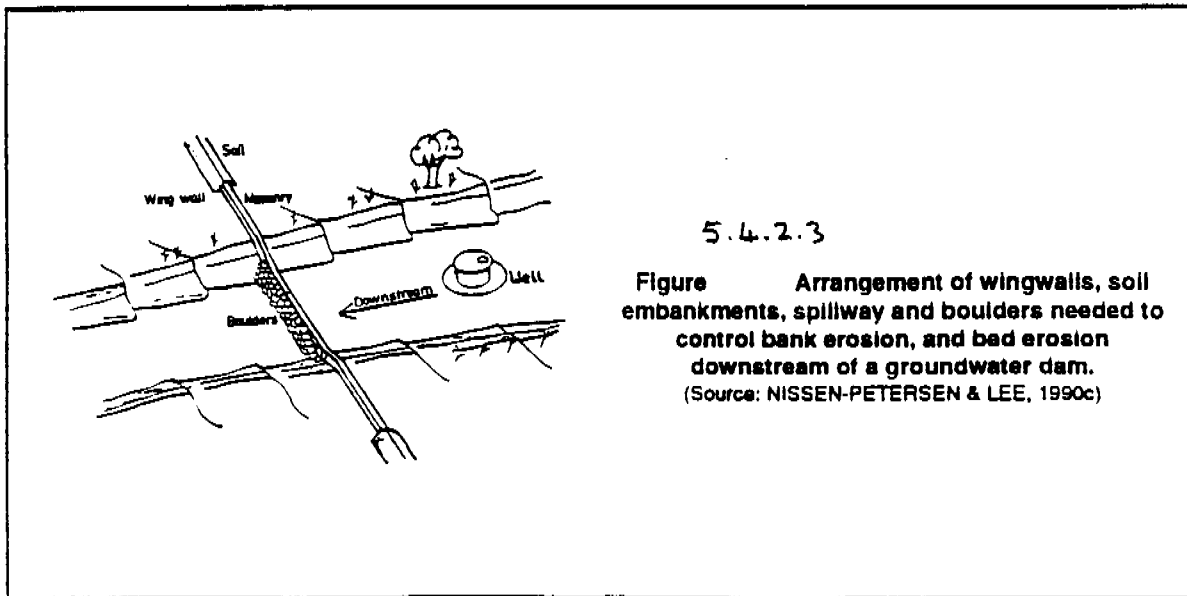
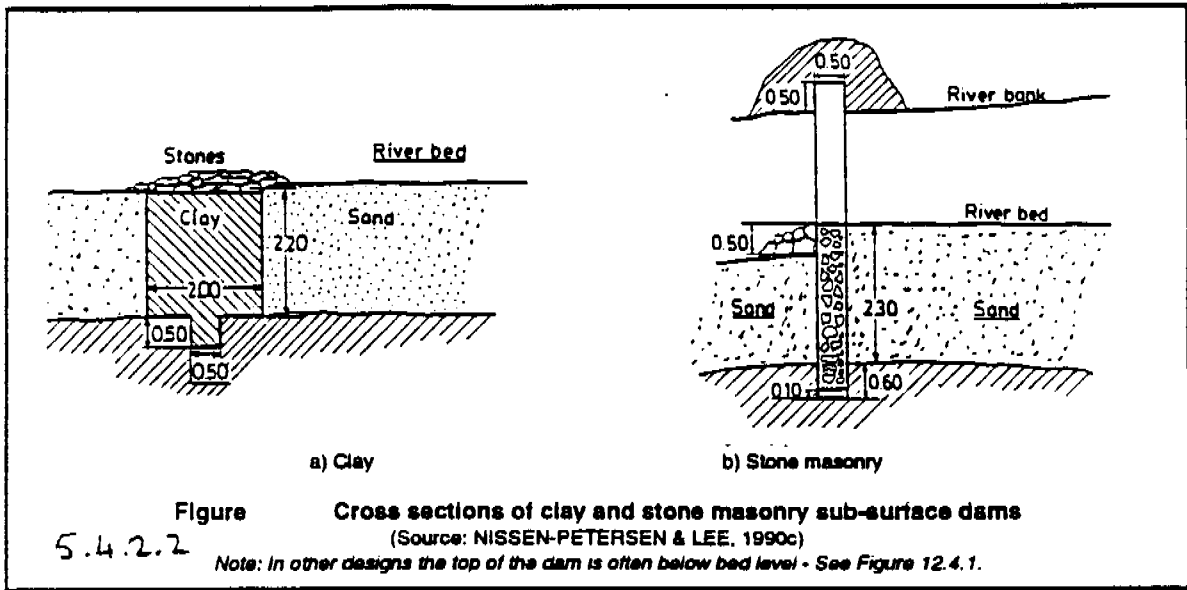
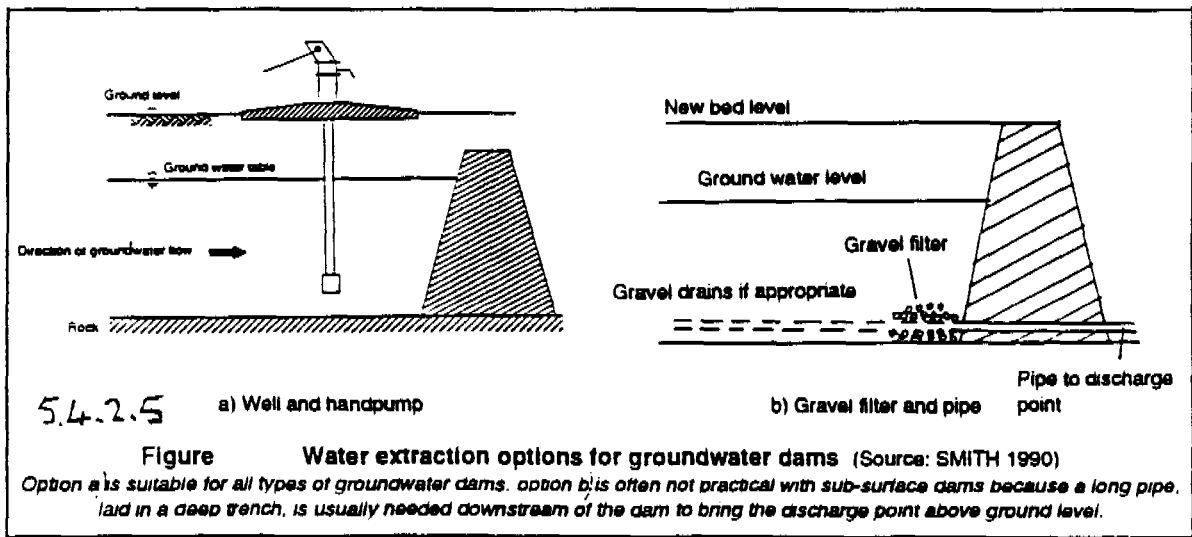
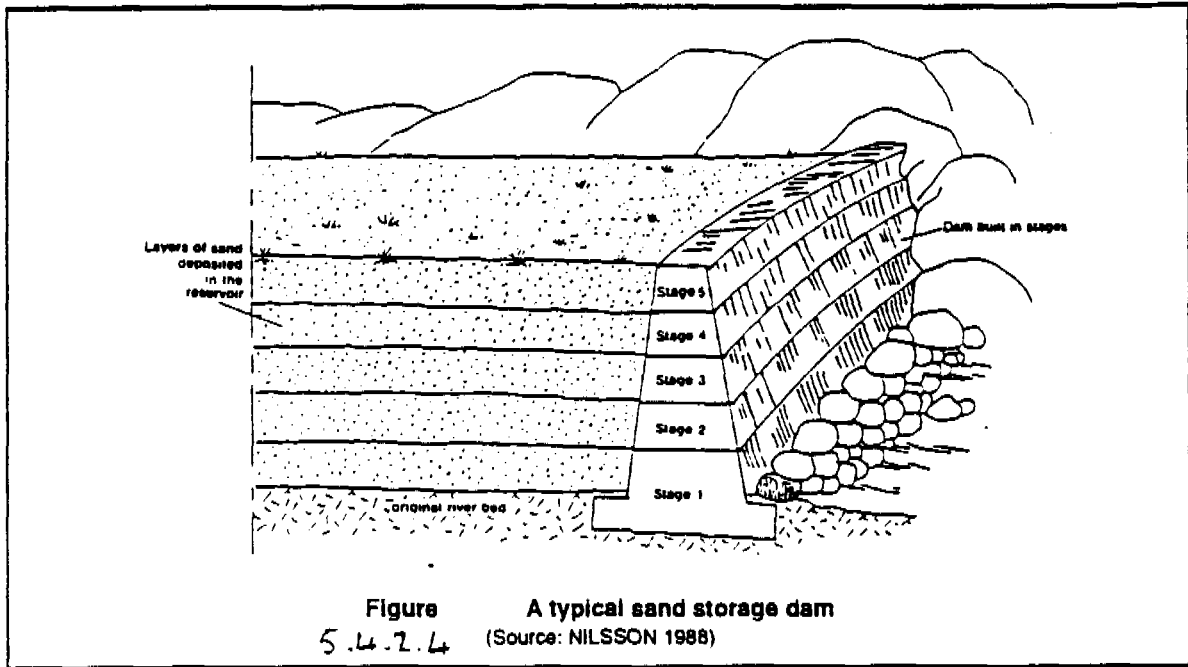

Figure 5.4.2.1 A sub-surface dam constructed from brickwork
(Source: Lee & Visscher 1990)





excavating trenches or holes which can be filled with selected granular material to form a filter through which water can gravitate or from which it can be removed by a suction pump.

The other type is a slow sand filter. This is usually constructed separate from the water source and is often partly or wholly above ground in a tank. Unless the water source is at a higher elevation than the filter, so that water can gravitate through the system a water lifting device is needed to raise the raw water to a level from where it can gravitate through such filters.

5.5.1 Man-made Infiltration Systems

In many respects these are similar to the infiltration systems discussed earlier except that they usually have a smaller surface area exposed to the water body because the granular material has to be transported to the site, or it has to be sieved out of excavated material, and this makes it expensive and time consuming to construct very large filters. This size restraint has the drawback that such filters are more prone to blockage than when filtering can take place through existing strata which usually has a large area in contact with the water. Smet and Wheeler (1990) give a useful review of infiltration systems.

If a pond has impermeable banks a man-made infiltration system can be created by constructing a well in the bank and connecting it to the pond by a wide trench filled with suitable sand and gravel to filter the water as it approaches the 'well' which acts as a reservoir (similar to what is shown in Figure 5.4.1.1). During the preparation of this report few reports of field experiences of such a system have been found but it is believed that UNICEF Nigeria are currently experimenting with this type of infiltration system (Larsson, 1992).

An alternative method is to excavate one or more trenches or a large hole in the bed of the pond and to fill it/them with sand and aggregate through which the water can filter. These excavations are connected to the bank-side well, preferably some pipes near to the base of the granular filling so that the filtered water has an easy flow path to the 'well' (similar to what is shown in Figures 5.4.1.2 and 5.2.7b). Yet

another method is to construct the filter on the base of the pond (Figure 5.5.1.1).

It is also possible to construct open reservoir excavations and associated infiltration systems beside a river. The excavations can periodically be flooded with water, preferably when the river is not carrying a high load of suspended solids to block the infiltration system. If two such excavations are used it will be possible to clean deposits out from one while the other remains in use. Alternatively one can act as a sedimentation reservoir to reduce the suspended solids carried in the water allowed to pass into the other which is equipped with an infiltration system (Figures 5.5.1.2 and 5.5.1.3).

Some man-made infiltration systems can be directly connected to a pump (Figures 5.2.2 and 5.2.6c) and this type of system has been used with a pond bed filter in some UNICEF projects in Nigeria and is being further investigated there (Larsson, 1992). The existing installations consist of a deepwell pump located on the bank of a pond, with a horizontal pipe connected below the cylinder to draw filtered water from a pond bed filter. The filter was made by excavating a hole 1.8m by 1.8m in plan and then filling it with layers of aggregate followed by coarse sand (Ismail, 1992). It was used with a filter fabric laid on the surface of the filter and this idea is discussed further below

Another example of a man-made infiltration system, sometimes called the 'Cansdale filter', is promoted by SWS Filtration Ltd., UK. This consists of an inverted glass fibre plastic box with a screen part way up the box to separate a clear space at the top of the box from a filling of fine aggregate. The box is buried in the granular deposits in a river-bed or lake-bed (Figure 5.5.1.4). Where the bed material is not suitable to act as a natural filter, such as would be the case with a clay bed, a hole is dug and this is then backfilled with suitable granular materials (Figure 5.5.1.5). In both cases the filter box is best surrounded with some fine aggregate and coarse sand. A flexible hose from the top of the inverted box is connected to a suction pump (such as the SWS Rower pump) which is used to draw surface water which is filtered as it passes through the sand into the box. The filter box unit alone is currently sold in the U.K. for £145 (300mm x 300mm x 600mm for up to 6

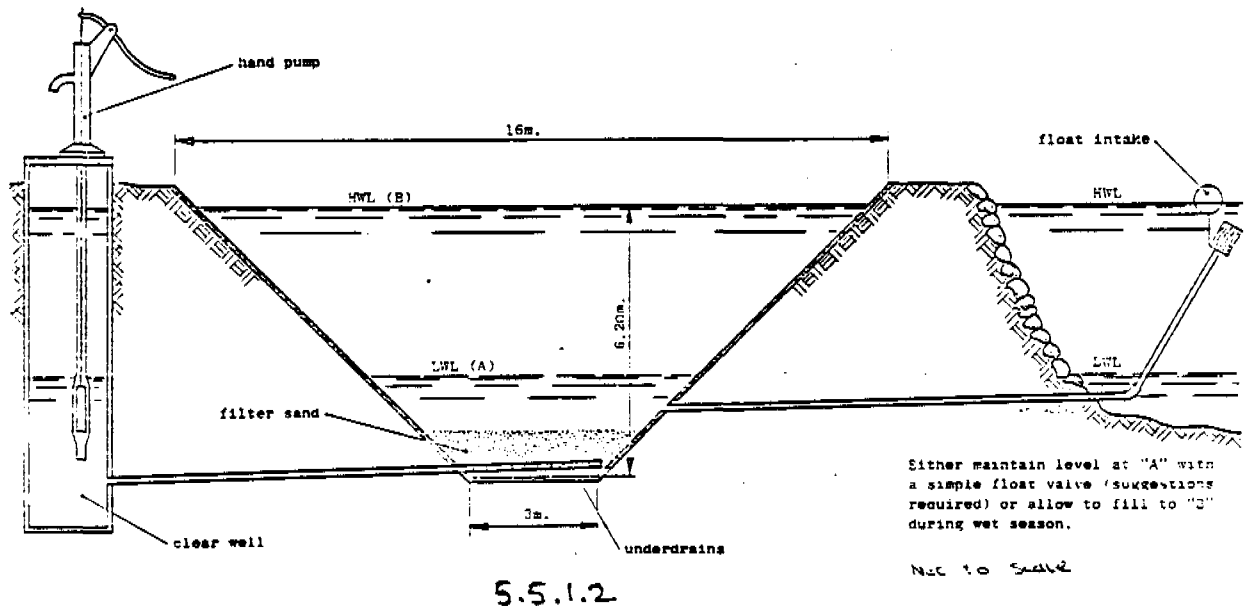
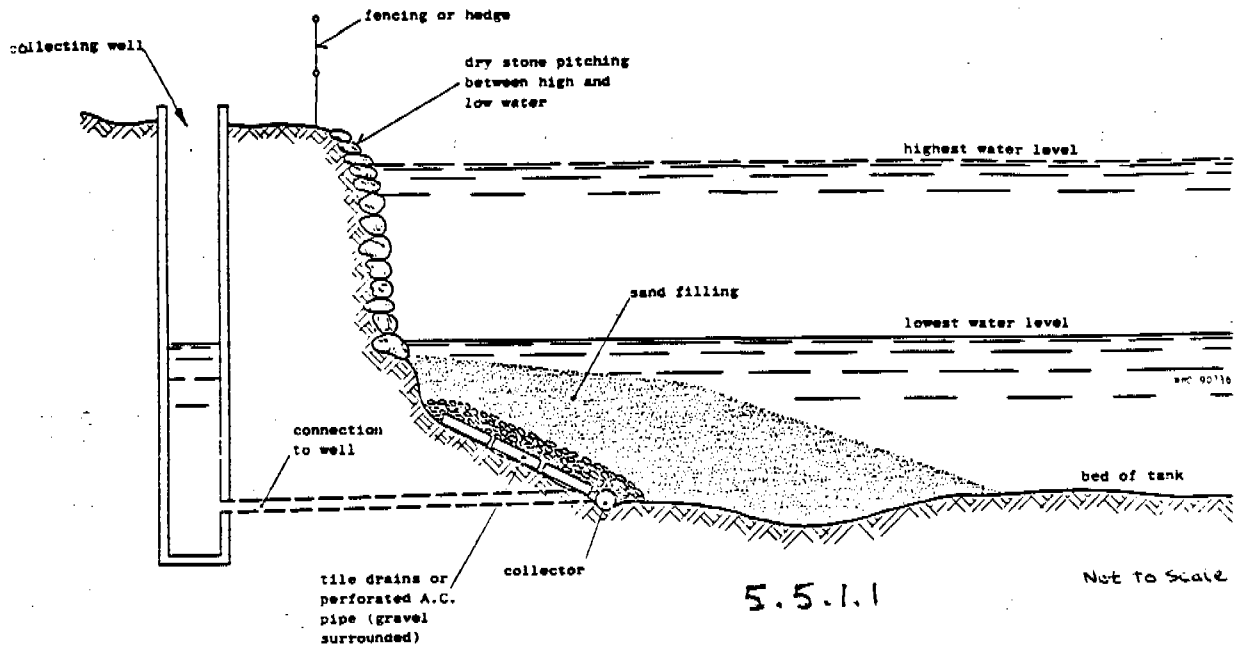

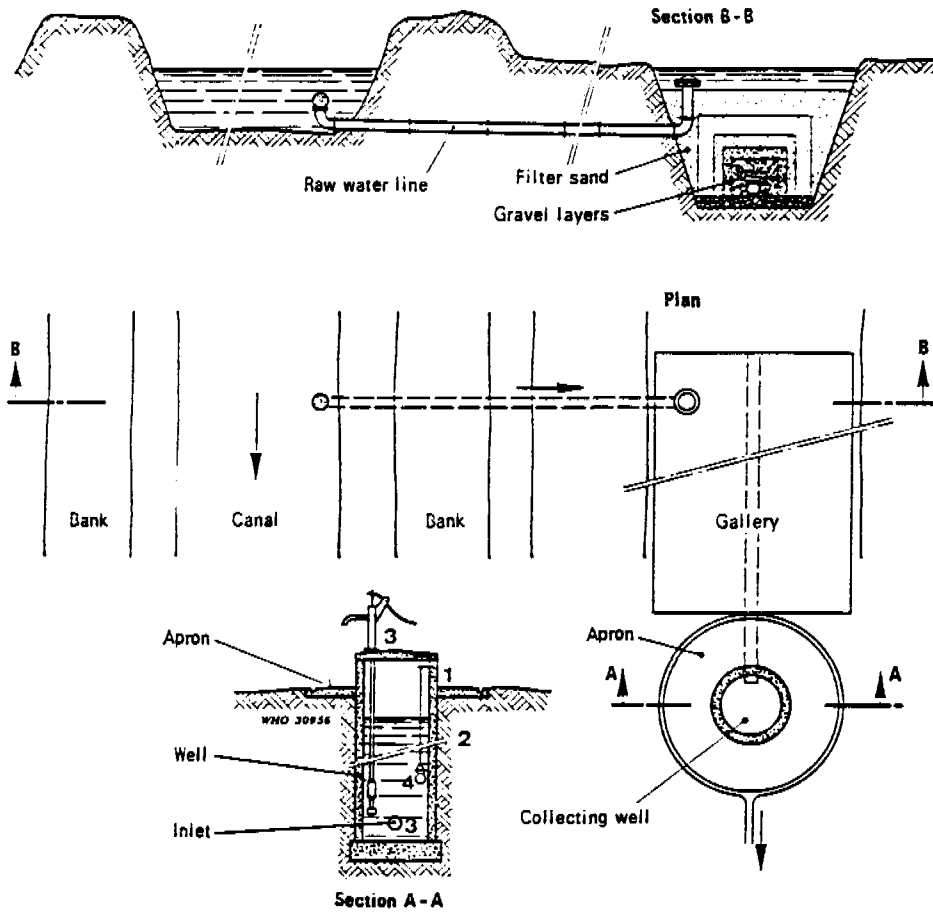

An infiltration gallery under a separate channel; the gallery is built before diverting the surface water over it. (From Raagopalan and Shiffman).

5.5.1.3

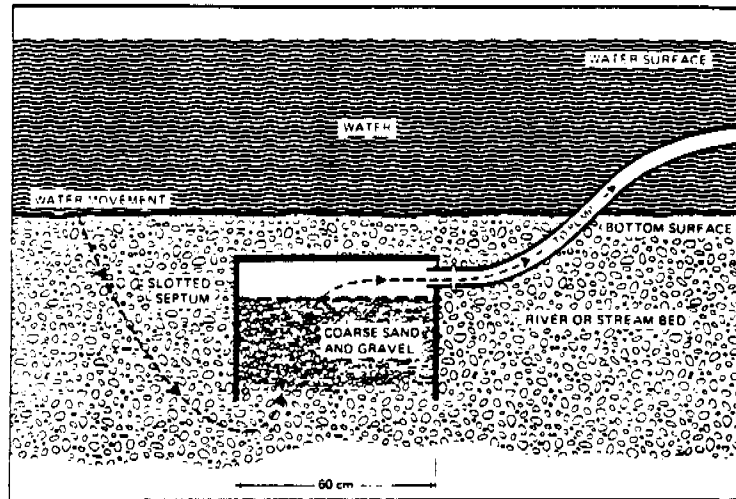

5.5.1.4 The S.W.S. filter. (From Cansdale).

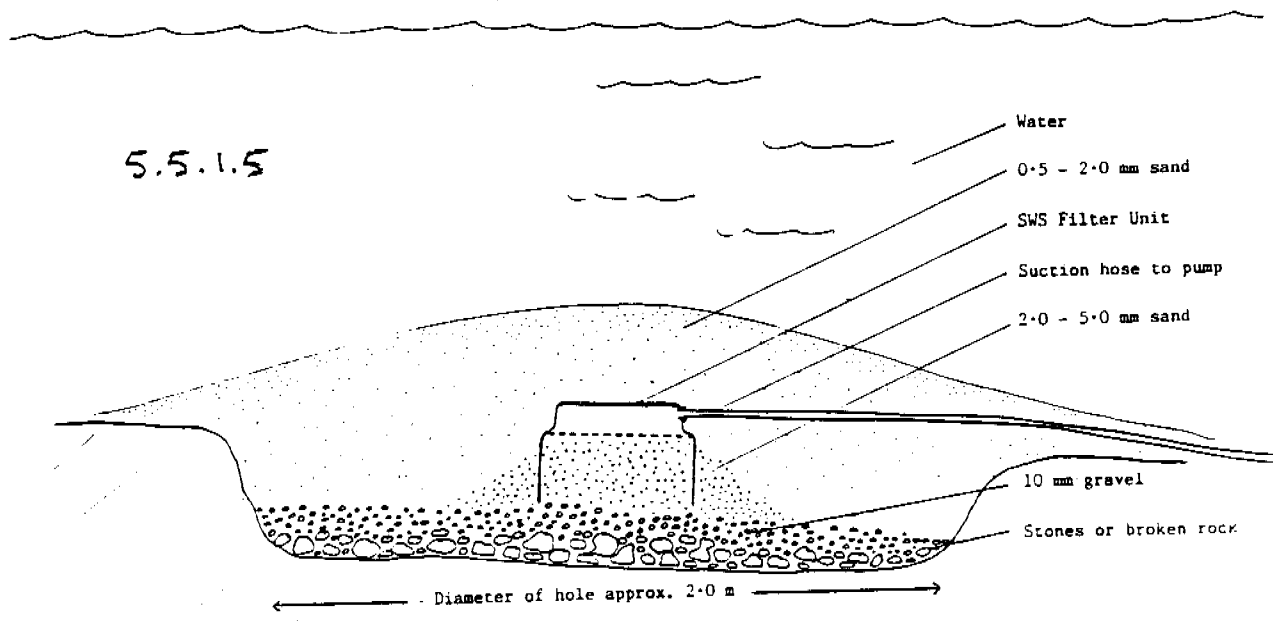

5.5.1.5

litres/sec) or £95 (300mm x 300mm x 300mm for up to 3 litres/sec).(SWS, 1992)

The whole SWS filtration system, whether it consists of imported material or existing granular bed material, is best 'developed' by frequently stopping and starting suction pumping through the system for a few hours using a powered pump. Pumping water in the reverse direction through the granular material can also help this development process which removes very fine material from the granular materials and which creates an improved grading of the filter (SWS, 1992). Use of the SWS filter box system in river beds in Nigeria is reported by Joy (1983).

SWS have also promoted a mini suction filter unit used inside a small upward facing box filled with granular material covered with a synthetic filter mat. This has been used by placing the box on the base of irrigation canals which were a source of schistosomiasis. Water abstracted through the box was free from cercaria but it was only suitable for use by up to about 10 people. The filter mat was periodically replaced when it became blocked, and after long periods of use the granular material in the box also needed washing or replacing. (SWS, 1992)

A summary of various field tests on SWS installations is given in Smet and Visscher (1990).

One of the disadvantages of all suction systems is that if a reciprocating handpump of any type is used there are numerous sudden changes in velocity of the water being filtered as the piston moves up and down the cylinder and this can draw solids and pollutants much deeper into the bed of filtering material than would be the case with gravity flow. This can lead to a poorer quality of filtered water and the deeper penetration of solids makes it much more difficult to clean the sand if it becomes clogged. However it is possible periodically to couple the suction hose to the outlet from a powered pump or a gravity supply from an elevated tank to gain some advantage from 'backwashing' while the sand is being raked to resuspend deposited solids. In a river, these solids can be carried away by flowing water, but in the case of a pond the solids may soon settle back onto the filter.

The biological treatment processes which take place on slow sand filters are not likely to become fully developed with suction infiltration systems, especially when use is only periodic. A evaluation of field installations of a number of the SWS filtration system (LSHTM & Gifford, 1986) indicated that the bacteriological quality of the water was sometimes not very good and such a system could therefore not be relied upon to produce high quality water. However it is to be expected that such systems will be effective in removing copepods which are much larger than bacteria. The removal of much of the suspended solids and attached bacteria is feasible with such infiltration systems so that they can be expected to lead to at least some improvement in the bacteriological quality. The system can of course be the first stage before another treatment process.

5.5.2 Slow sand filters

For a long time it has been recognised that slow sand filters are especially appropriate for producing potable water for communities in developing countries. They can produce water of high quality from bacterially contaminated surface water without the need for complicated plant and operational procedures usually found in other types of conventional water treatment systems. Organisations such as the International Reference Centre for Community Water Supply and Sanitation (IRC) has been active in promoting research and field tests to find appropriate designs of filter (Visscher et al. 1987) and appropriate methods of reducing the turbidity of surface waters to a level where slow sand filters can operate (Smet & Visscher, 1990).

It appears that most of this research has been directed towards serving communities generally larger than the 250 - 500 people being considered in this report. Such small communities can be served by small slow sand filters but during the preparation of this report there were no field reports were found which show that in practice such a community are able to run and maintain them properly.

For good performance slow sand filters should operate continuously and should receive a steady flow of water and they are therefore best served by a regulated gravity supply direct from the

source or from an elevated tank filled by a pump. This requirement often cannot be met or cannot be afforded in small communities. If the community is scattered a relatively expensive centralised slow sand filtration system its position may not be sufficiently convenient to encourage universal use.

A slow sand filter needs periodic cleaning and initially this is achieved by the simple operation of skimming off a thin layer of sand. Unfortunately for a few days after this operation the bacteriological quality of water from the filter drops until the biological purification process is re-established in the new top layer, although the use of a geotextile filter mat speeds up this process. During this 'ripening' process the water passing through the filter has to be run to waste or used for non-potable purposes while drinking water is supplied by another filter or from a storage reservoir filled by the filtered water before maintenance started.

Eventually, because the periodic removal of sand leads to an excessive reduction in the depth of the sand bed in the filter new sand has to be added. During this procedure and for 3 - 7 days afterwards while the filter 'ripens' no good quality water can be obtained from the filter and again the community has to rely on stored water or another filter.

Where the source water is turbid additional complications can arise from the need to provide and maintain a 'roughening' filter to reduce the level of suspended solids to a level which will not quickly block the slow sand filter. The turbidity of water suitable for slow sand filtration should usually be less than 20 NTU to give a reasonable length of filter run. So for many surface water sources some form of pre-treatment (eg. sedimentation, infiltration or roughening filtration) is often needed, particularly during the rainy season.

From the above discussion, and from an understanding of other control procedures necessary with slow sand filters which have not been mentioned, it may be concluded that although the running and maintenance of slow sand filters may not be technically very complicated it does demand a trained person. This person needs to be able to understand the treatment process and to always carefully follow

the important maintenance and operation procedures. He or she needs to be willing and able to regularly commit time and effort to this work and will probably need to receive some payment from the community as an incentive.

The evidence suggest that the number of communities of 500 people or less in which slow sand filtration is sustainable is very small. However, where the conditions for success appear to be present it should be considered since such a treatment process produces a high quality potable water.

Packaged treatment plant

Small packaged slow sand treatment plant which can be quickly installed in a community have been successfully field tested are available from some manufacturers. One such unit is the Potapak which uses polyethylene tanks 1.25m diameter and 1.2m high and simple flow control devices connected by plastic pipework (Figure 5.5.2.1). The same size of tank used to hold the filter sand can also be used to hold gravel to form a prefilter to pretreat high turbidity water and the tanks are designed for stacking together to save space during shipping. The sand and gravel for the filters is not supplied with the units so it needs to be locally available. Two composite filter mats, each held in a separate plastic frame, are used on the surface of the sand filter to trap most of the suspended solids, a useful function which is discussed further at the end of this Section. The top mat is removed and washed clean weekly and then replaced below the other mat. This interesting procedure causes little disturbance to the useful biological processes which take place in the mats and upper layer of sand. The pipework also allows a gentle backwashing procedure to be periodically carried out to remove accumulated silt from the upper layers of sand. (POTAPAK 1992)

Each unit can give an output of about 12m³/day. The unit cost of the Potapak for a purchase of at least 10 slow sand filter units is about £2070 FOB UK port each. The gravel filter units are about £900 FOB UK port. The cost of a storage tank for the treated water is excluded from these figures. As mentioned above it is also necessary to provide a continuous flow of water to the filters.

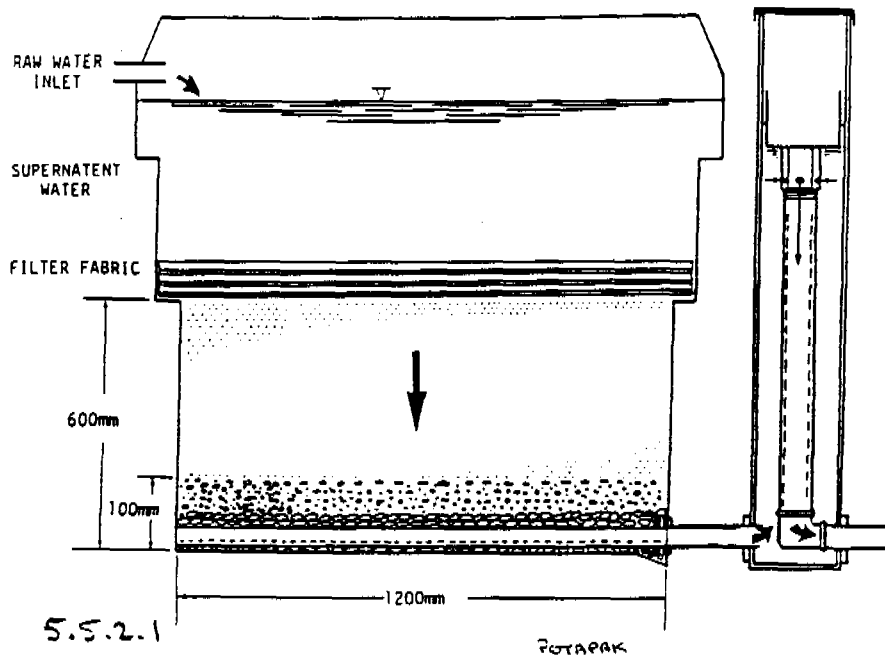

5.5.2.1 Dimensions and construction of package plant and flow controller

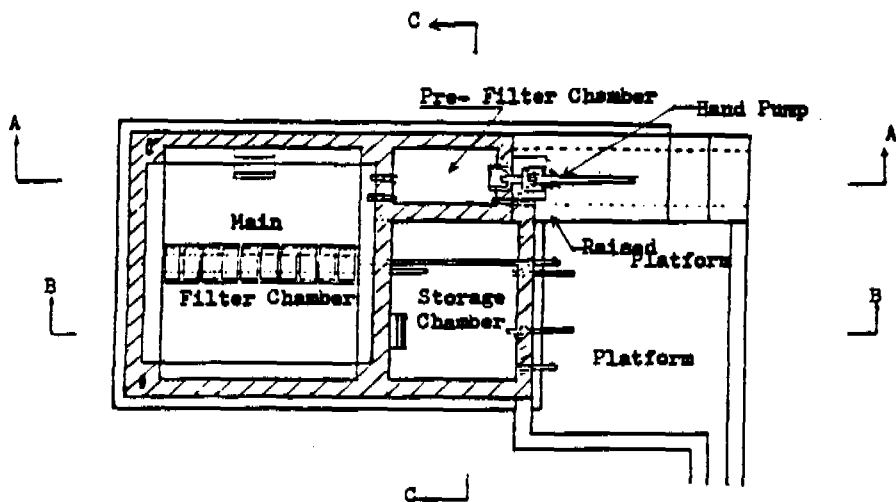

Plan view of large PSE without lid

5.5.2.2

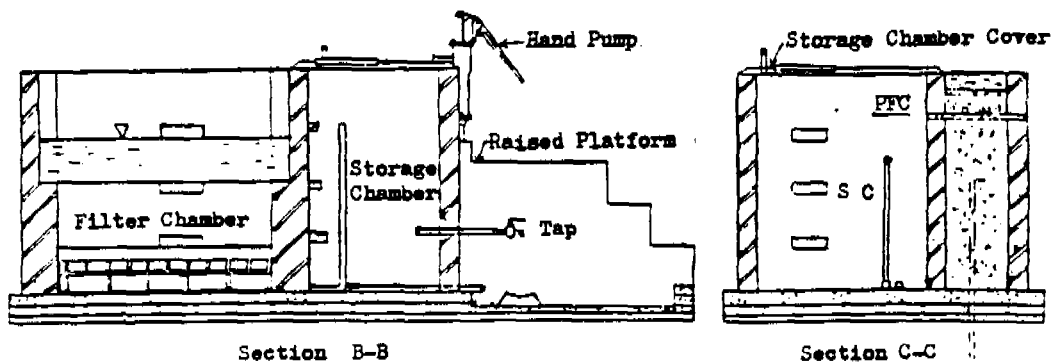

Section B-B

Section C-C

Potapak are willing to consider providing variations to their standard system to meet the particular demands of purchasers (POTAPAK 1992). In many situations it would be possible to considerably reduce these costs by constructing ferrocement tanks.

It is suggested that further investigation into reducing the cost of packaged treatment plants is carried out. In the meantime a few of the existing units could be installed in communities which showed the most promise of operating and maintaining the units and if such a field test was successful it could be repeated elsewhere using the reduced cost plant. Alternatively the packaged plant could be replaced by a more permanent slow sand filter unit and the original unit could be tried out in another community.

Pond sand filter

Since 1984 field testing of a small slow sand filter for improving water from ponds has been carried out in Bangladesh (DPHE & UNICEF 1989). A report on their performance was recently produced (WHO, DPHE & UNICEF 1991).

The pond sand filter (PSF) has been promoted in two sizes one for up to 300 users (PSF300) and one for up to 500 users (PSF500). Each consists of a small two chamber tank constructed above ground (Figure 5.5.2.2). Water is lifted from a screened floating intake in the pond by handpump from which it is discharged through a prefilter into the water above the sand in the filter chamber. Originally coconut fibre and brick chips were used in this prefilter but this is now discouraged and only brick chips are recommended (WHO, DPHE & UNICEF 1991). Water which passes through the sand filter is collected at the base of the filter chamber from where it flows into the adjacent storage chamber. It is collected from the chamber using a pipe connection to a tap.

The report on the performance of 153 PSF systems found that 18% had been abandoned and a number of the others were not being well cared for (cit. ibid). Unfortunately only 22 installations were tested for bacteria, and it seems that these tests were for numbers of 'total coliform' rather than the more specific faecal coliform. Somewhat surprisingly in the light of the general evidence of the indifference of users

to the proper care of the system, in 18 of these installations no coliform bacteria were identified per 100ml tested but the other 4 PSF units had unspecified coliform counts greater than zero. The raw water in 55% of the ponds serving these PSF had total coliform counts of less than 10 per 100ml and in the others the counts were all less than 25 per 100ml which again seem remarkably low.

The report also investigated the users attitudes to water quality and the use of the system. It is rather surprising that there are no reports of lazy people drawing water from the tap without pumping an equivalent amount of water into the filter chamber. The rate of filtration is about 4-9 litres/minute so unless users are patient the system requires that people draw filtered water which was pumped into the filter chamber by another user.

Amongst other things, the report came to the conclusion that the use of PSF units should continue where there is no alternative source of potable water but that greater beneficiary participation is necessary in construction and operation of the units and that health education in the community and training of the caretakers is very important.

It would seem therefore that the PSF does have potential for treating pond water to potable standard and since it removes bacteria it can be expected to effectively also strain out any infected copepods that reach the floating intake. However the present authors have reservations about its widespread adoption for reliable removal of bacteria in situations which may differ from those in Bangladesh.

These reservations include firstly the fact that the flow rate through the filter is likely to be subject to a number of changes throughout the day as it varies from zero to the maximum rate controlled by the difference in level between the top water level in the filter chamber and level of the inlet pipe in the storage chamber. The flow rate during the night may cease all together since the amount of water held above the bottom water level in the filter chamber (the same level as the top of the inlet pipe in the storage chamber) is relatively small and this may soon pass through the filter. As previously mentioned

such changes in flow are detrimental to good slow sand filter performance.

Secondly if there is only one PSF unit it will not always be able to supply bacteria free water because immediately after the top layer of sand is scraped off the quality of the water will reduce and it will not return to a good standard until a day or two later when water passing through the filter has caused the useful bacteriological layers to re-establish. The water passing through the filter during this period should not be used for drinking water. Someone therefore needs to be willing to pump the water without gaining the benefit of potable water.

Thirdly the design seems to omit instructions for filling the filter chamber with water from the bottom when the sand is first installed, or when subsequently it is replaced after washing. This is usually recommended for sand filters because initial filling from the top often traps air in the pores of the sand which adversely affects the performance of the filter. It appears that this initial filling could take place via the storage chamber if the vertical pipe in the storage chamber (see Figure 5.5.2.2) was temporarily removed. Ideally filtered water should be used for this process. If raw water is used it must be strained to remove copepods which might otherwise survive in the storage chamber. The use of raw water will also introduce some bacteriological contamination into the chamber which may persist for some time.

Finally, as mentioned earlier, the running and maintenance of such a sand filter needs the dedication and commitment of a well trained and highly motivated caretaker. Such a person may be hard to find and train in many of the smaller communities which are being considered in this report.

Despite these reservations the use of PSF units should be considered where no other appropriate methods of producing potable water are available. Even if a PSF does not produce bacterially free water the quality can be expected to be much better than that of the surface water from the source, and the filtered water should always be copepod free. Further experimentation, design changes and field testing in Guinea worm endemic areas may

overcome some of the problems mentioned above.

Domestic sand filters

The use of very small slow sand filters for treatment of water for an individual family has been suggested by a number of authors. The designs are often based on the use of old 210 litre oil drums to contain the sand (e.g. Yaziz & Din, 1988, Cairncross & Feachem, 1986, Morgan, 1990) but in the preparation of this report no literature concerning their widespread use has been discovered.

UNICEF Kenya has in the past promoted the use of an upward flow water filter based on the use of two cement mortar jars one acting as an untreated water reservoir and the other as a filter (Childers & Claasen, 1987). The filter jar contained a thick layer of charcoal sandwiched between two layers of fine sand (Figure 5.5.2.3). An evaluation of the performance of this filter was carried out by Singh and Chaudhuri (1992) and they came to the conclusion that the reduction in faecal coliform from its use was not sufficient for it to be used alone to treat moderately contaminated water, but that it should be used with another jar with a 600mm layer of sand acting as a conventional (downflow) sand filter.

UNICEF Nigeria is currently evaluating a number of designs of domestic sand filter (Larsson, 1992)

Domestic sand filters will usually lead to reductions in the numbers of faecal pathogens and should always exclude copepods. However, there are reservations about the effectiveness and sustainability of household sand filters to produce bacterially pure water. The main criticisms relate to the rate of flow and the sustainability of operation. With most designs (such as that in Figure 5.5.2.4) the rate of filtration is likely to regularly vary from zero to a value near to the maximum rate and as explained for the pond sand filters this is likely to adversely affect their performance. A few filters designs (such as Yaziz and Din (1988)) have another design fault which is that the outlet pipe which leaves the bottom of the filter is not raised above the level of the top of the sand. This omission is a bad feature since without

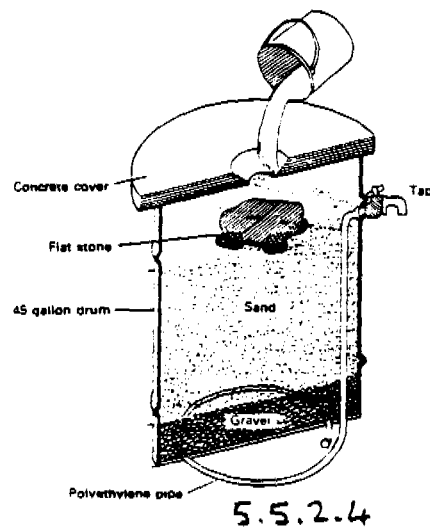
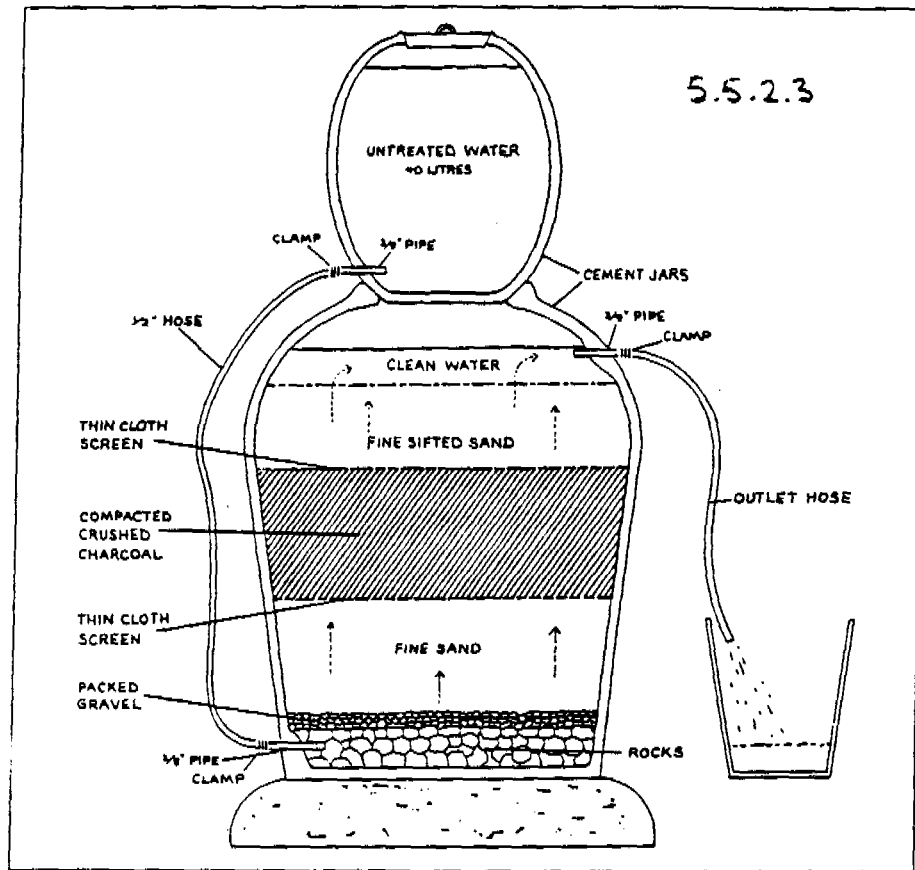

such a feature the whole filter bed can be inadvertently be drained from the low level tap.

Often the depth of sand is less than the absolute minimum of 0.5m usually recommended for slow sand filters (Visscher et al. 1987). Also with these small filters the ratio of the area of sand in contact with the wall of the container to the horizontal cross sectional area of the bed is very high compared to any conventional slow sand filter. This means that in the small filters a higher proportion of the raw water passes down the easier flow path next to the wall (where it is not filtered as efficiently as in the main bed of the filter). This detrimental effect can be reduced if the walls of the vessel are very rough.

In addition, many designs do not have a facility for filling the sand filter from the bottom when the filter is first commissioned or when the sand has been washed and replaced. As explained for the pond sand filter this is often detrimental to the subsequent performance of the filter since air can otherwise become trapped in the sand.

A final criticism is the suspicion that a member of each household will be insufficiently motivated to maintain the filter properly, even when they have been adequately trained. Also after the sand has been skimmed or replaced the filter will not provide good quality water. A storage vessel to contain previously filtered water for drinking will therefore be required during the period that the filter is producing lower quality water. This low quality water can of course be used for other domestic uses and need not be wasted.

As was noted for the pond sand filters, although domestic slow sand filters may not produce bacterially pure water if there is no other available source of drinking water they can be useful because with a reasonable standard of maintenance they should improve the quality of the raw water from an unprotected surface water source. An arrangement similar to that shown in Figure 5.5.2.5 or 5.5.2.6 would seem to show most promise but as can be seen to satisfy the requirements for good slow sand filtration the layout and operation becomes rather complicated. For best performance, for the reasons listed above, initial filling in both these systems would need to be carried out through

the last pipe (for example by using water poured into it via a funnel).

More field work is required to examine the practicalities, effectiveness and cost of such domestic filters and the ability of families to use and maintain them properly. If the surface water source is acceptable for domestic uses other than drinking and the community realise the need to only drink filtered water then the size of filter required need only relate to the small volume of water used for drinking purposes.

The use of cement mortar jars as containers for the filter sand would appear to be promising but there could be problems with large vessels when it is necessary to empty the sand when it needs to be cleaned or replaced. Flexible plastic tubing cemented into holes made in the jars would seem to be the best type of interconnecting pipework (see Section 4).

Use of geotextile filter mats

In recent years there has been some interesting research into the use of one or more layer of thick open-weave geotextile fabrics on the surface of conventional slow sand filters to make it easier to clean the filters (e.g. ODA 1989, Wheeler et al. 1986, Graham, 1988). The advantage of the use of such fabrics is that they can be periodically removed from the filter surface carrying with them much of the deposited solids which can then be washed out of the material before it is replaced. This leads to much longer 'filter runs' because it takes much longer for the top layer of sand to clog. The use of fabrics also means that the upper layers of sand are not disturbed very often. This is important since in these layers useful straining, adsorption and predation by micro-organisms leads to a dramatic, or even complete removal of pathogenic bacteria and viruses (Visscher et al. 1987). Such fabrics are used with the small Potapak packaged slow sand filtration water treatment plant mentioned in the last section and with the much larger Oxfam slow sand filtration treatment package (OXFAM undated).

As previously mentioned the purification processes which take place in bank or bed filtration systems are not identical to those in slow sand filtration and the same level of microbiological predation and straining action

Improving water quality by filtration

River water may be the only source available at times, but it is often dirty and not hygienically safe. A simple treatment system to supply up to eight families can be built using four covered jars, four valves, plastic tubing, sand (0.5-3mm and 0.5mm grade) and gravel, as follows.

The tubes can be fitted to jars either by making holes in the walls when the mortar is still soft or by cutting holes with a small hammer and a chisel (made from a sharpened screwdriver). Tubes can then be seated in with cement mortar.

Jar 4 is for the storage and settlement of the untreated water and should be as large as possible. Valve A is fitted at the bottom and is used for cleaning out the jar. Valve B is fitted about 100mm above A and controls the flow of water to jar 2. Jar 4 is raised above the other jars in the system to provide pressure to push water through.

Jar 2 is an upward flow filter which will remove much of the coarse dirt. A 250 litre jar can treat 20 litres of water an hour. Back-wash the filter weekly by closing valve B and opening valve C to drain the jar. Clean, but not hygienically safe, water can be drawn from valve D.

Jar 3 is a downward flow filter. A 250 litre jar can treat 20 litres an hour.

It is cleaned by draining the standing water off the top and scraping the top 20mm of sand away every two or three months.

Jar 4 is the container for safe drinking water.

• Tests in Thailand show that the treated water can be free of faecal bacteria for prolonged periods of use.

• Information supplied by S. B. Watt (UK), H. Mann (UK), Mr Opas (Siam Cement Co, Bangkok, Thailand), Professor R. Suwanik (Siriraj Hospital, Bangkok, Thailand).

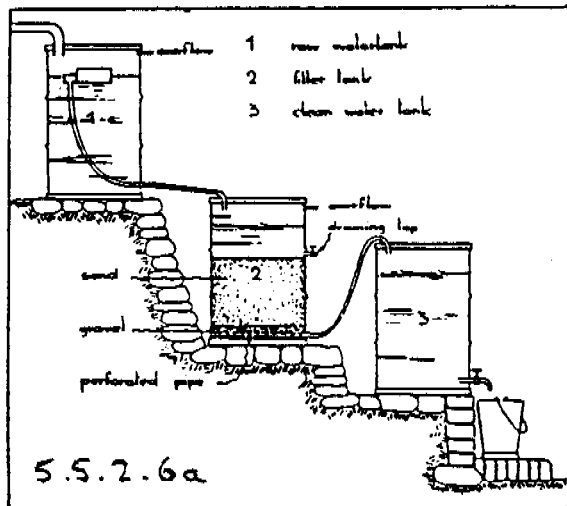
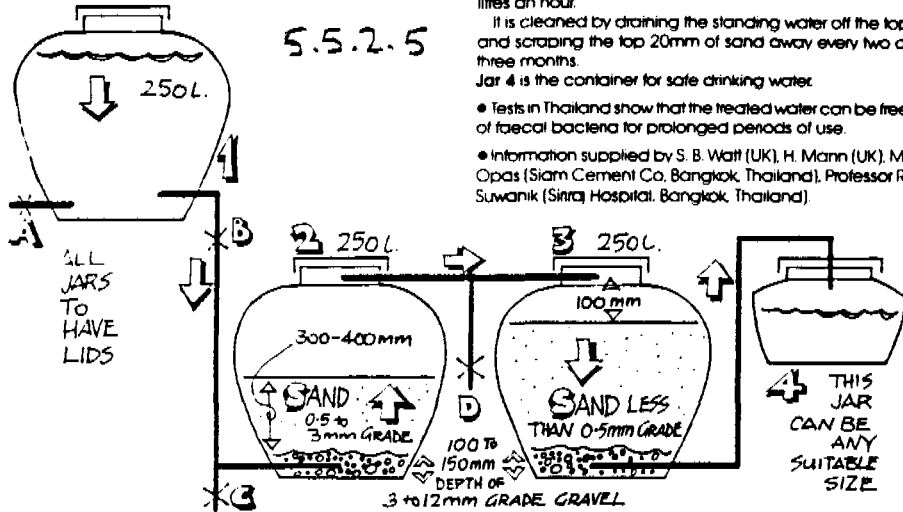

Slow sand filter system

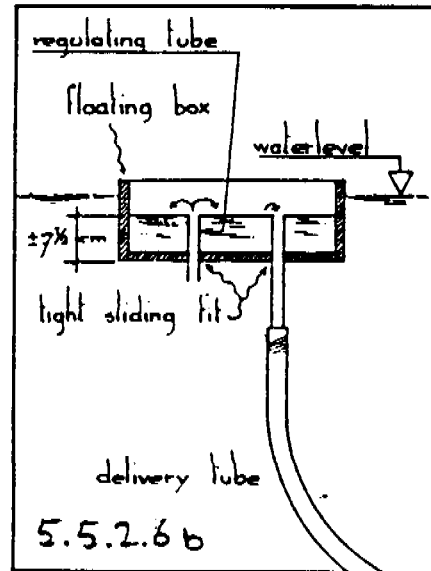

Floating bowl in raw water tank

which is useful for the removal of pathogens can not be expected to result. However, the use of filter fabrics such as those described above could be useful in any man-made pond infiltration systems which have to deal with turbid water since they should be effective in reducing the rate at which the infiltration system will clog up, but some method of removing and cleaning the fabric will be need to be developed and ultimately the sand will also need cleaning. Large areas of dirty fabric will be very hard to handle and clean, so in such situations, smaller overlapping pieces will probably be needed.

It is suggested that the use of fabrics with pond-bed infiltration systems, pond-bank infiltration systems, above ground pond sand filters and possibly with domestic slow sand filters is worthy of further research, development and field testing.

5.6 Ground Level Rainwater Catchments

The collection of rainwater runoff from ground level surfaces is considered to come into the category of surface water. There are three categories of ground level catchments:

unimproved natural surfaces;
improved natural surfaces;
artificial surfaces.

Different aspects of these surfaces are discussed in the following sections.

Ground level surfaces are likely to become contaminated in a number of ways including deposits brought onto the catchment by people, animals (domestic and wild) and birds. If possible the area which contributes runoff to a reservoir should therefore be fenced off and the community should be educated as to the importance of avoiding entry into such areas and of keeping animals away from the catchment areas in order to reduce the risk of subsequent pollution of the runoff.

However pollutants can also be brought onto the surface by wind and surface water from outside the fenced area. Very little can be done about the wind borne deposits but proper sanitary practices in the surrounding area will reduce the risk of faecally contaminated dust being blown onto the catchment. With some catchments it

may be possible for the surface to be periodically swept with a clean brush used by someone with well washed feet. The entry of surface water from outside the fence can usually be prevented by raising the ground around the edges of the catchment and/or using free draining ditches to intercept and carry away the polluted surface water (Figure 5.6.3 and 5.7.1). The use of fences, ditches and bunds is also recommended around ponds to prevent the entry of polluted surface water from the land immediately adjacent to the pond, especially that falling in the area where users approach it to collect water.

The quality of the water entering the storage pond or reservoir can be improved by making it necessary for the water to first pass through a sedimentation pond, silt trap and/or a gravel filter or a coarse sand filter. These will need maintenance since the collected silt, sand and debris will need to be periodically removed or they will block the filter or be carried on into the stored water. There is not much information available about the performance of such methods of improving the quality of water caught from surface catchments but details of some arrangements are shown in Figures 5.6.1 and 5.6.2.

Although above existing ground level has many advantages this is not usually possible with ground-level catchments. However it may be feasible if the slope of the ground is sufficient to allow water from a catchment to gravitate to a downstream above-ground tank (Figure 5.6.3) or if a dam can be constructed (Figure 5.6.4). During the preparation of this report only a few references to below ground storage were found. Some relevant details are given in Section 5.7.

The size of ground level catchments and the associated storage are calculated in the same way as for above ground tanks and catchments using an appropriate runoff coefficient for the surface. When calculating the volume of storage of uncovered or unlined reservoirs it will also be necessary to allow for the evaporation and seepage losses which can be quite high.

Some communities encourage floating plants to cover the water surface of open ponds to reduce evaporation losses but it is not clear whether this method is effective. Raised banks of excavated material around the reservoir or trees planted

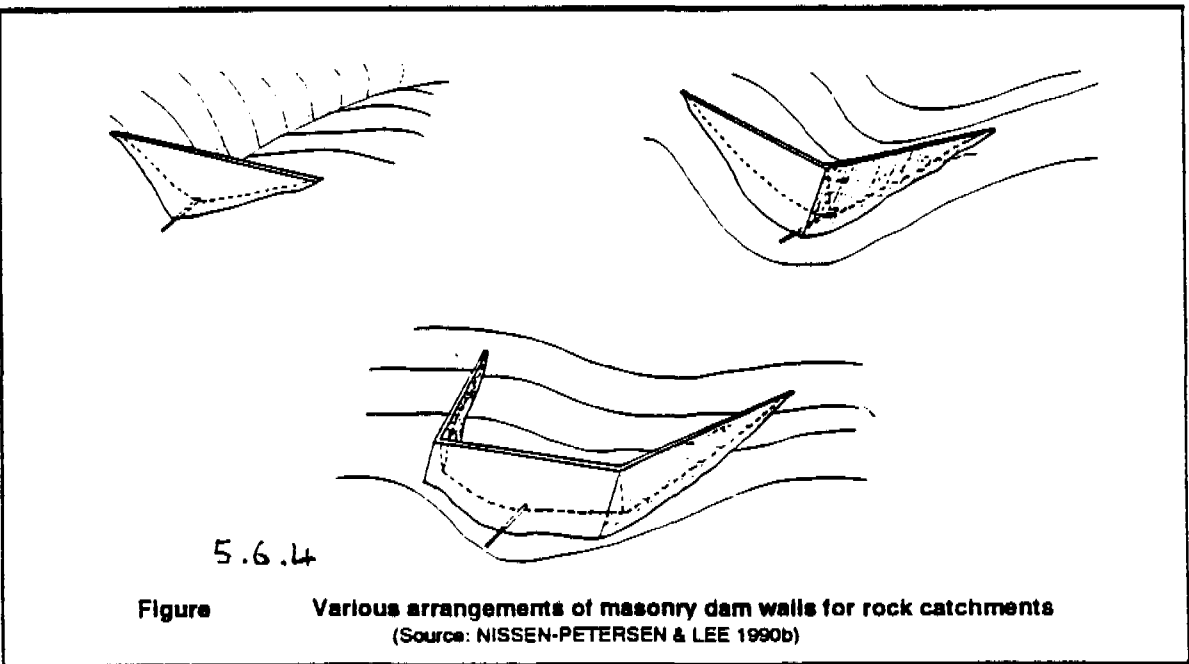
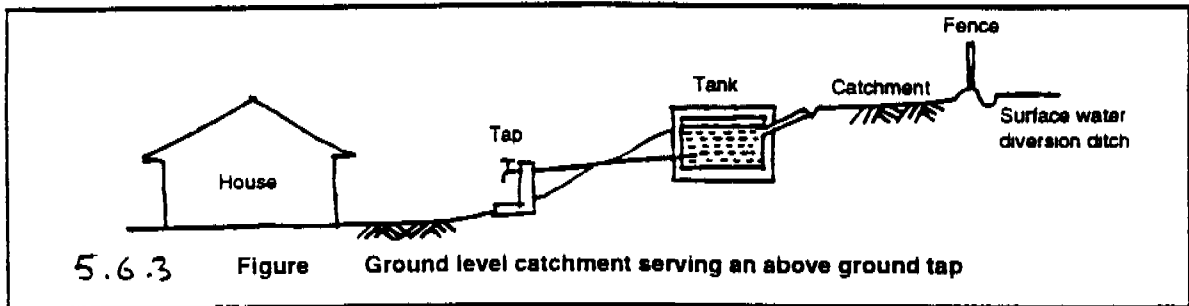
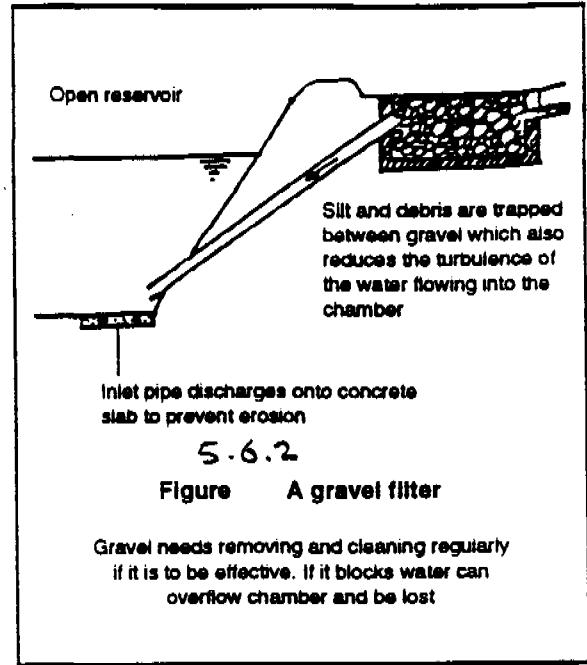
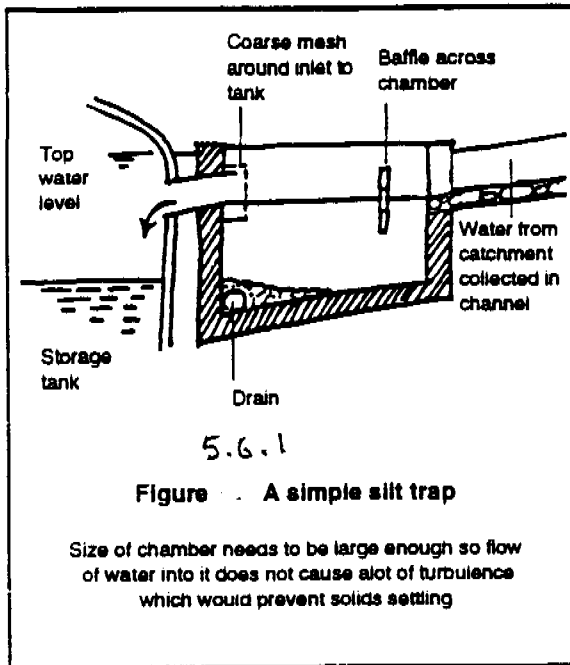

nearby (but at a distance where their roots do not draw water from the reservoir) can reduce wind velocities and consequently evaporation.

Unimproved surfaces

The best natural land surface is a smooth sloping surface of impermeable rock or of soils with high clay content (especially ones on which a natural impermeable crust forms).

The proportion of runoff which can be collected from a natural catchment depend on the soil and the slope of the land. On steeper ground small depressions are less likely to intercept the flow but the problems of erosion of the surface becomes more of a problem. Natural land catchments, if sloping less than 1 in 10 (10%), will rarely have runoff coefficients above 0.3.

Improved natural surfaces

The runoff coefficients of natural surfaces can be improved by a number of techniques including the addition of cement, lime, clays or chemicals to the soil (Maddocks, 1975). The simplest method, but one best suited to mechanical plant, is to smooth and compact the soil. The use of none of these methods is usually feasible in the small communities on which this report focuses, but the less effective manual methods of improving the catchment are also worthwhile. These include the removal of vegetation (as long as this will not promote erosion), the smoothing of the catchment area and the filling of depressions. Rock catchments can be considerably improved by removing soil and vegetation and filling any open joints with clay or cement.

Some local technologies such as mixing soil with clay, marl, lime or dung are used in a number of developing countries to produce fairly hard impermeable surfaces for flat roofs, floors to houses or threshing floors, and these have obvious applications to small ground level catchments. Threshing floor catchments are used in Botswana (see Figure 5.6.5).

Artificial ground level catchments

Numerous artificial ground coverings have been used in developed countries for rainwater catchments. Most of these are based on a layer of impermeable material (such as concrete or bitumen) applied to the surface, or sheets of flexible membrane (such as PVC or butyl

rubber) laid over the surface. Such surfaces are usually quite costly and are therefore rarely appropriate in developing countries.

One interesting form of catchment which could be cost effective is suggested by Morgan (1990) and is illustrated in Figure 5.6.6. This uses a large piece of plastic sheeting buried in sand to protect it from physical damage and deterioration due to sunlight. No details are given by Morgan about the long term performance of such catchments but like the polythene lined tanks mentioned later, the sheet may be susceptible to attack by termites. One advantage of the use of the sand on the polythene is that it will strain out some of the contaminants that might be carried onto the catchment.

Another design, proposed by Kukita (undated) of UNICEF Namibia uses a polythene sheet unprotected by sand but no field report of its use was available for examination at the time of writing this report. It is believed that it was envisaged that the sheet would only be used during four months of each year (presumably just during the rainy season) and that it would be stored out of sunlight for the rest of the year so that the useful life of the polythene could be as long as to 5 or 6 years.

5.7 Below-Ground Tanks And Reservoirs

5.7.1 Unlined Excavations And Natural Depressions

If the soil is fairly impermeable then water can be held in any natural depression or excavation and such ponds provide a water sources for many people in developing countries. Such tanks are widely used in countries such as Yemen and Sudan for example. Evaporation and seepage losses from such water bodies can be quite high over a long period. The evaporation losses can be reduced by using deeper reservoirs, which will have a smaller surface area per unit volume. The seepage losses can be reduced by some form of lining.

5.7.2 Lined Excavations And Natural Depressions

Traditional linings

Clay lining although labour intensive is feasible if suitable material is readily available. Sandy clays are preferable to pure clays since they are less likely to crack when the water level falls and they dry out. Sometimes there is already sufficient clay in the base and sides of the pond but it needs to be 'puddled', that is worked when wet and plastic to improve its impermeability. This can be done on a small scale by people trampling it with their feet, but driving livestock back and forth over the clay rich soil is more effective for larger scale projects. The addition of cattle dung to the soil on the floor of the reservoir is also reported to prevent seepage (Nissen-Petersen, 1990) and presumably after a period of time it offers no risk of contaminating the water.

Polythene lining

Polythene sheeting is not very strong and it is easily punctured during and after installation. Also it is not very easy to make waterproof joints between sheets and it rapidly deteriorates when exposed to sunlight (although black polythene is more resistant to ultra-violet deterioration than clear polythene). It is inferior to the very expensive man-made membranes such as PVC and butyl rubber but it is likely to be the only membrane material affordable in the situations considered in this report.

Widespread successful use of polythene membranes is not reported in the literature but it has been tried in Botswana. Gibberd (1969) reports the use of four layers of 0.0381mm thick polythene sheets sandwiched between thin layers of mud and protected with sloping revetments made from layers of horizontal tubes of polythene sheet filled with a weak cement mortar mix and pinned together with heavy gauge wires (Figure 5.7.1). Gould (1984) reported that for various reasons only four of the tanks constructed by this method in Botswana and Zimbabwe proved to be successful but he suggests that if they are carefully constructed this design could give good service. Pacey and Cullis (1986) indicate that a similar technique has been used in West Africa.

Some designers have suggested the use of a vertical cylinder of polythene in a cylindrical excavation to form a storage tank. This was recommended by Kukita (undated) in conjunction with the polythene catchment

mentioned above. He proposes that the inside of a 1.2m diameter excavation which is 5m deep is first lined with mud to prevent any sharp stones piercing the polythene. He suggests that the sheets should be joined with splicing tape. The reliable performance of this tape is critical to the success of the reservoir. The reservoir is covered with a slab equipped with a handpump in a similar way to a protected well. A similar idea was noted in a French publication where the polythene sheet was ready supplied in a long flattened cylindrical form which can be drawn together at one end which is then tightly bound with string and doubled back on itself before being tied again to produce a waterproof end.

One problem often encountered with polythene linings is damage from the roots of plants and trees and from the action of termites. The former two can be controlled to some extent by careful siting and maintenance. Insecticide is recommended by some authors to control termites but in a study of 'hafirs', which used various arrangements of polythene sheeting and layers of mud for lining, Pontin and Woolridge (1977) found that even when insecticide was used, termite damage was still the main cause of failure. In areas where this problem might not occur or where it can be overcome there is potential for further field tests of polythene lined tanks.

Un-reinforced cement mortar lining

Unreinforced cement mortar lined excavations with capacities of up to 10³ are reported to be used in Togo and ones of up to 8m³ to be used in Tanzania (Lee & Visscher, 1990). O'Brien (1990b) briefly reports the use in Togo of a 12.8m³ capacity cement lined spherical pit with a dome shaped concrete cover using no metal reinforcement which used materials costing US\$240. Since the mortar is not reinforced the risks of cracking must be high unless the soil is very firm. Where no field experience of successful un-reinforced mortar linings is available it is therefore suggested that ferrocement, although probably more expensive, is the safer option.

Ferrocement lining

Above ground ferrocement tanks were discussed in a previous section and many of the above ground designs can also be buried. The use of excavated ferrocement lined hemispheres was

also mentioned in that section and this method of construction has been well proven in Kenya where sizes up to 100m³ have been constructed (Gould, 1992), often using barbed wire to provide additional reinforcement to the chicken mesh [Nissen-Petersen & Lee (1990a), UNICEF, (1986)]. The timber framed roof (Figure 5.7.2) originally used with such reservoirs to reduce the rate of evaporation and to protect the stored water was found to rot. Now a domed ferrocement roof is preferred, supported if necessary by a central concrete pillar. WaterAid have used a conical ferrocement roof and supporting pillar in a design promoted in Kenya (WaterAid, 1992).

Sand filled reservoirs

Some writers suggest the use of excavations in impermeable ground filled with sand and gravel and to store water in the pores between such granular material (Figure 5.7.3). Like the groundwater dams discussed earlier this reduces the rate of evaporation and offers some protection from contaminants. The disadvantage of such an idea is that because the voids only take up a small volume of the material (rarely more than 25% for a natural river deposit (Nilsson, 1988)) a large excavation and a large volume of imported sand are needed. However rates of evaporation from exposed water surfaces can be as much as 2000mm per year compared to the very low rate from a filled excavation so the actual volume of water needing to be stored is less. Water is usually extracted from such sand filled reservoirs using a well with a suitable water lifting device.

5.8 Improving The Quality Of The Water By Settlement, Long Term Storage, Solar Disinfection Or Chemical Disinfection At The Users Home

5.8.1 Settlement

If it is not feasible to purify surface water by some method of filtration improvement can result from allowing the suspended solids to settle and then abstracting the clearer water from the top of a vessel or reservoir. This has already been mentioned with respect to the use of floating intakes and sedimentation ponds.

A domestic method using the same principles, sometimes called 'the three pot system' is

promoted in some countries. It follows a three day cycle. On the first day water collected from the source is put into a pot where it is left undisturbed so that the suspended solids can settle out. The next day the clearer water at the top of the first pot is carefully poured into the second pot. The dirty water and settled solids in the bottom of the first pot are then emptied and it is refilled again from the water source to start another cycle. On the third day the clear water at the top of the second pot is poured into a third pot which is used for drinking water.

In addition to the benefit of the clearer water obtained from settlement this process also results in the removal of those bacteria which are attached to the settled solids. Although this will improve the bacteriological quality of the water it will still be polluted by other bacteria so still cannot be considered to be safe. If there are infected copepods in the water they too may be removed by this settlement process but it should not be relied upon as a removal method. Their removal is much more reliably carried out by straining which can take place as the water is poured into the drinking water storage vessel.

If water is collected from a source which contains species of snails which are intermediate hosts in the transmission of schistosomiasis (bilharzia) the water may be infected with cercariae which can infect man (Section 2). These become non-infective after about 48 hours (Cairncross and Feachem, 1983) so the risk of transmission of this disease through drinking water is removed by any sedimentation or storage methods which hold the water for more than two days after collection from the source.

Some communities use locally available coagulants such as powdered Morinda seeds (Jahn, 1981) or alum purchased from local markets to act as a coagulant to speed the rate at which the finer solids settle in a single pot. Such coagulants can of course still be used together with the three pot system to improve the effectiveness of the process. These coagulants usually capture many of the unattached bacteria which settle with the flocs (cit. ibid.), leading to a much higher rate of removal than by using settlement alone and sometimes giving a removal rate as high as 99.9 per cent (Sutherland et al., 1990).

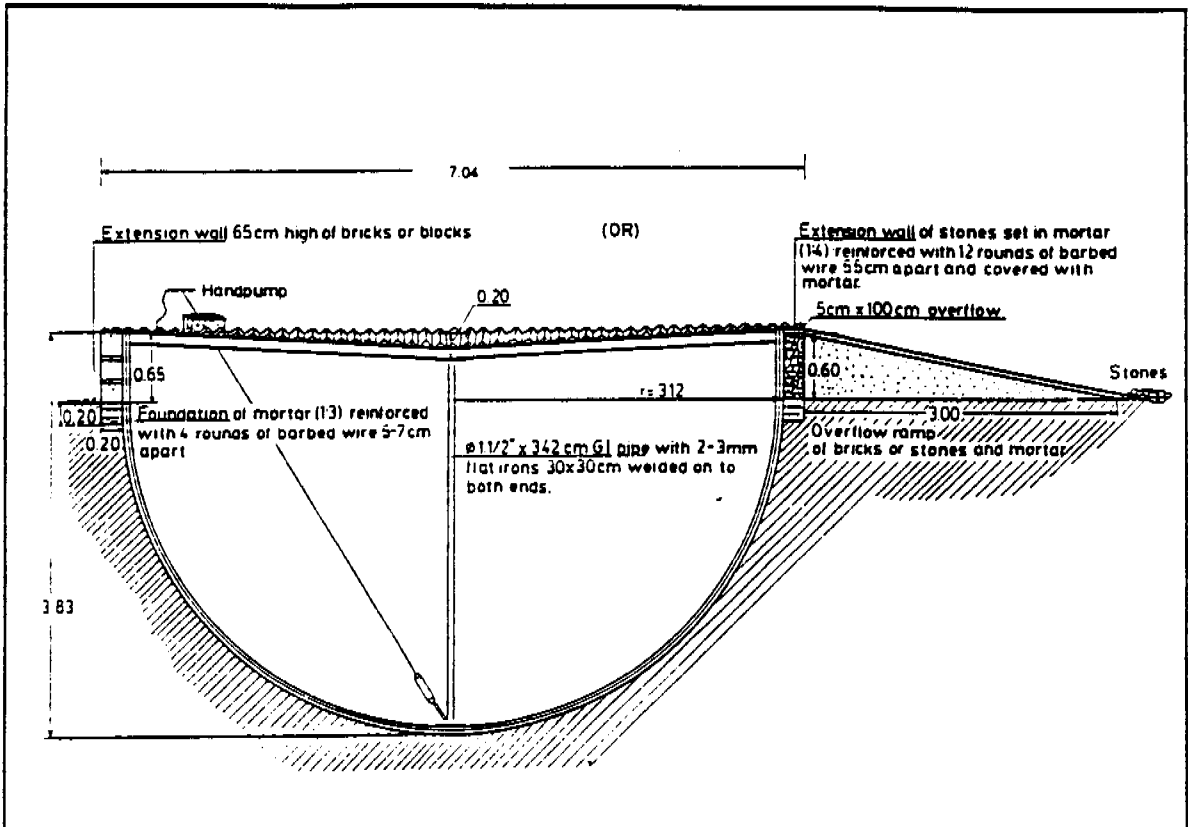

5.7.2

Figure Cross section of hemispherical ferrocement tank
(Source: NISSEN-PETERSEN & LEE 1990)

The ferrocement is 55-60mm thick reinforced with strands of 16g barbed wire at 200mm centres and one layer of chicken mesh

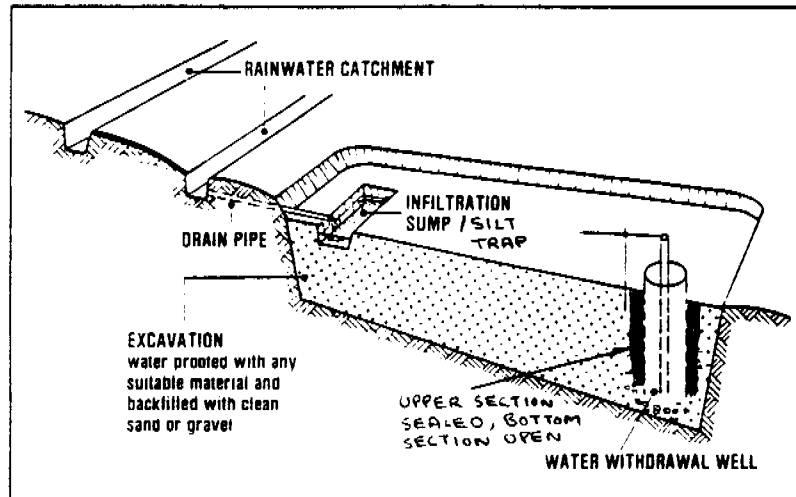

Figure 5.7.3
Artificial recharge using rainwater

Source: ITDG

Settlement alone does not produce good quality water and often cannot over a few days produce completely clear water. Although settlement alone or settlement after small scale coagulation and flocculation will not produce bacterially free water they give useful improvements to the quality of the water and should be promoted where sustainable. Both are useful for preceding sand filtration methods because the removal of settleable solids will extend the period of operation of a filter. They are also useful prior to chlorination since they will reduce the wastage of chlorine which oxidises organic solids, some of which will be removed by settlement and most of which could be removed by the use of coagulants.

If the use of natural coagulants such as Moringa seeds can be promoted then the speed and amount of clarification which takes place will be considerable and the resulting quality of the water will be much improved. Further investigation into existing field experience (eg. [Dian Desa (1985), Jahn (1984) and Sutherland et.al (1990)] of such coagulants should be carried out to see if they are worth promoting for domestic use.

Cement mortar jars are useful containers in which settlement of suspended solids can take place in a home. Where other better interventions are not available it is recommended that the use of such jars should be promoted together with straining out of copepods.

5.8.2 Long Term Storage

If surface water is stored for a long period then there is more time for suspended solids to settle out and this can lead to a clearer water.

Fortunately, because the conditions in storage vessels are not very conducive to the survival of faecal bacteria after a period of time these also die. Although some studies have been done into the rate of die off in open reservoirs (WRC, 1975 and Smethurst, 1979) this study has not found much research relating to the die off rate in smaller covered vessels. One reference (Jahn, 1984) quotes some research from Tanzania (MWDEM, CIDA & SIDA, 1979) which showed a 90 per cent die-off for most bacteria after two days of storage. It is foreseen that with highly turbid waters taste and odour problems

may arise from the growth of anaerobic bacteria during long term storage so it would be best to precede it with some settlement to reduce the organic content of the water to a minimum.

Muller (1972) found that infected copepods lived for a maximum of 50 days. They may live for a much shorter period in the unnatural environment of a covered container and this aspect might be worthy of further study if there are communities where straining is unlikely to be adopted but where long term storage would be acceptable.

If long term storage of surface water for drinking purposes is feasible in a community then there is another way of avoiding the consumption of infected copepods. This is to store water collected outside the season when copepods are infected with Guinea worm larvae and to consume only this water during the infective season(s). It is doubted whether in practice this pattern of consumption could be implemented and it would probably be much easier to protect against the transmission of Guinea worm by straining, and if feasible to use long term storage to improve the bacteriological quality.

If a system of domestic filtration of water which does not remove all bacteria is adopted then subsequent long term storage may possibly be used to allow them sufficient time to die off.

Cement mortar jars with lids would seem to be ideal storage vessels for long term domestic storage. It is suggested that a more exhaustive literature, search and further investigation into the effectiveness or practicalities of long term domestic storage is carried out in the field.

5.8.3 Solar Disinfection of Water

In the early 1980s work by Acra at in Beirut (Acra et al., 1984) showed that exposing a bottle of clear water to intense sunlight for a few hours resulted in the deaths of many, if not all, of the faecal bacteria contained in the water. This is as a result of mainly the ultra-violet component of the sunlight. Since then numerous other researchers have examined this phenomena. In 1988 a workshop brought many of these researchers together to discuss the topic and the

proceedings give a state-of-the-art review (IDRC, CRDI & CIDD, 1988).

The workshop confirmed Prof. Acra's findings that solar radiation exerts a germicidal effect on small quantities of bacterially contaminated water. However such treatment is not feasible during periods of continuous rainfall and heavy overcast conditions. It has been demonstrated that on a clear sunny day, clear water, with a bacterial coliform count of less than 1000 coliforms/100ml will usually be free of live bacteria after about 3 hours exposure in a clear transparent glass or plastic bottle (cit.ibid). At a radiation rate of $500\text{W}/\text{m}^2$ this is accomplished in a longer period of about 5 hours (cit.ibid). The effect on other pathogens found in water is also reported and research is continuing in this field. Literature on the effect of solar disinfection on copepods has not been noted but they are probably unaffected by it.

The use of solar disinfection therefore certainly has potential for improving the bacteriological quality of clear water during certain seasons of the year but as yet it has not been extensively field tested to see how its adoption by people in rural communities works out in practice but a more extensive literature search may discover some field reports.

It would seem that where bottles are available, and clear bacterially impure water sources are in use, that there is nothing to lose from the introduction of this technique if people find it acceptable. Since the water will become warm during its period of exposure it will probably be considered unsuitable for direct consumption and it will need storing until it has cooled. It is best stored in the same container in which it was exposed so that there is no danger of it becoming contaminated when stored in another vessel but this will mean that a large number of bottles will be needed. The water drawn from the suction infiltration systems or floating intakes mentioned earlier in this section should in particular benefit from solar disinfection.

5.8.4 Domestic Chemical Disinfection

Problems with the use of chemicals by householders to kill copepods was discussed in Section 5.3.1. The fact that chlorine and iodine will also kill faecal pathogens was noted. For the

reasons given in that section the authors do not consider that domestic chlorination of drinking water to make it bacteriologically pure is sustainable in the type of communities being considered in this report. No field reports of its extensive use for this purpose in such situations are known to exist.

6. CONSIDERING THE COMMUNITY

This study has investigated 'Cost effective technologies' for eradication of Guinea worm and for potable water supply for small communities.

None of the technologies investigated will be effective without adequate consumer involvement.

This involvement by households and communities may be reflected in community management of projects or in customer choice of technologies. Any involvement will be dependent upon information, education (particularly health education) and communication from project sponsors and other interested agencies.

The results of this study indicate that *appropriate CHOICE* between the various options for cost effective technology is more significant than any individual technology. It is not the role of this study to investigate programme implementation. However, to achieve cost effective technology the implementation process must be designed to enable consumers to choose the technology which they find to be most suitable. Obviously most consumers do not have the opportunity to understand all the options available. Therefore it is the responsibility of the sponsors to present *the most relevant options in any particular geological, hydrological and economic setting in a way that consumers can understand and appropriate.*

To maximise community involvement and therefore ensure health and social benefits the role of implementers needs to change from a *'top-down project based approach'* to a *'market research and development with consumer choice based approach'*.

This change from a *'supply driven'* approach to a *'demand led'* approach will require a significant change of thinking on behalf of project managers and administrators. The role

changes from that of engineering designer and provider to market researcher and seller.

Figure 6.1 illustrates the likely affects of a project approach where rapid take-up can be achieved but with a significant reduction in benefits when the initial phase is completed. The community or consumer (or customer) approach will always have a longer time lag but will be more efficient and effective in the long term. **For sponsors who desire sustainable benefits as rapidly as possible the only solution is to increase their spending on information, education and communication (marketing and selling) dramatically to encourage a faster take-up of the consumer's choice of improvement.**

Further information on promoting community involvement and demand-led approaches to eradicate Guinea worm and domestic water supply may be found in:

Community-Based Initiatives To Eradicate Guinea Worm: A Manual for Peace Corps Volunteers (Silverfine, Brieger and Churchill, 1991);

Guidelines for Health Education and Community Mobilization in Dracunculiasis Eradication Programs (CDC, 1991);

Adding Guinea worm control components: Guidelines for Water and Sanitation Projects (Prins and Yacoob, 1988);

Infrastructure for Low-income Communities (Franceys, 1991).

7. CONCLUSIONS AND RECOMMENDATIONS

There is a large range of cost-effective technologies available for water supply in Guinea worm endemic areas.

For the sake of long-term consumer understanding and health promotion it is recommended that wherever possible assistance should be aimed at providing potable drinking water, not just water free from infective Guinea worm larvae.

The results of the research indicate that the issue is not primarily the determination of a *cost-effective technology* but rather the *choice of technology suitable for a particular location*. This is of vital importance to achieve lifecycle cost effective technologies which are necessary to ensure sustainability.

Locations differ according to socio-economic, hydro-geological and hydrological conditions. To obtain the most suitable *choice* the community/household/consumer need to be involved in an education, information and communication process that will enable users to make their own choice according to their understanding of improvements in health and convenience and according to their willingness to pay for sustaining those improvements.

The desired rate of implementation can be achieved only by innovative use of promotion and marketing campaigns not normally associated with 'civil engineering products'.

Cost effectiveness of implementation is likely to be enhanced by the encouraged involvement of private sector suppliers.

The starting point for upgrading to potable water free of Guinea worm is normally to improve existing water sources, though the protection of potable water is difficult with surface water sources.

Life-cycle cost effective technology choices: Groundwater

When making *choices*, the exploitation of groundwater is normally the first priority since

it can often supply sufficient quantities of good quality water.

Within this category every effort should be made to cap any spring sources (and where possible to pipe the water to a number of more convenient collection points)

If there are no springs and communities are scattered but groundwater is relatively shallow, a number of hand drilled/hand dug wells with Blair type bucket pumps should be promoted. Where population density is higher the same technologies can be used with direct action handpumps.

If the ground conditions make it necessary, powered mini-rigs are applicable with deepwell open top cylinder pumps for water collection from beyond 15m depth.

Life-cycle cost effective technology choices: Rainwater

Where groundwater cannot be exploited, rainwater catchment using roof catchments with supported 'V' gutters and cement mortar jars can be promoted to give a good quality of potable water. Nylon sack catchments can be used where there are only thatched roofs.

Life-cycle cost effective technology choices: Surface water

Where there is no alternative but to use existing surface water sources, strainer boxes can be used to prevent Guinea worm as an interim measure even where there are no pumps.

The next stage of improvement for surface water is to use hand powered suction pumps with floating intakes protected by strainers.

Neither of these methods remove pathogenic bacteria so they should be promoted in conjunction with household cement jars for storage (with strainer covers as an added precaution). Any length of storage will begin to reduce the risk from pathogens not removed by straining.

Surface water sources should be upgraded to infiltration galleries or river bank wells to ensure potable water at the earliest opportunity.

Portable, individual strainers have a vital role to play as back-up to the other methods of preventing the ingestion of Guinea worm larvae and these can be used by people moving away from protected household sources.

REFERENCES

Acra A. et al., (1984), Solar Disinfection of Drinking Water and Oral Rehydration Solution - Guidelines For Household Applications in Developing Countries, American University of Beirut

Akhter M., (1990), SWACH: An Integrated Approach to Control Guinea Worm Disease in India, Water Quality Bulletin, Vol. 15, No. 1, Canada Centre for Inland Waters, Burlington, Ontario, Canada, pages 23 - 28, and 63,

Akhter M., (1992), Surgical extraction of Guinea Worm. WATERfront, Issue 1, Water and Environmental Sanitation Section, UNICEF, New York, page 8

Appan A., Villareal C.L. and Wing L.K., (1989), The Planning, Development, implementation of a Typical RWCS: A Case Study in the Province of Capiz, proceedings of the 4th International Conference on Rainwater Cistern Systems, Manila, Philippines (quoted by Gould (1991))

Arlosoroff S., Tschannerl G., Grey D., Journey W., Karp A., Langenegger O., and Roche R., (1987), Community Water Supply - The Handpump Option, The World Bank, Washington, D.C., USA

Bauman, Erich, (1992), (Handpump specialist with 3 years recent experience in Ghana, SKAT, Switzerland), personal communication.

Beale, G. Water Management Consultants (1990), Development of the Drilling Industry in Nigeria - An Overview, (unpublished), quoted by de Rooy (1992)

Blankwaardt, Bob, (1984), Hand Drilled Wells - A Manual on Siting, Design, Construction and Maintenance, Rwegarulila Water Resources Institute, Dar es Salaam, Tanzania

Bradfield W.J., (1992), Extracting clean water from streams in south-western Ethiopia. Waterlines, Vol. 10, No. 3, Intermediate Technology Publications, London, U.K., pages 30 - 32

Brandford, Bonnie, (1992), Focus on Thailand. Raindrop Rainwater Harvesting Bulletin, Volume 7, Water and Sanitation for Health Project, Arlington, Virginia, U.S.A., pages 1,3,6,7 and 10.

Brieger W., Ramakrishna J. and Adeniyi J., (1986), Community Involvement in Social Marketing: Guineaworm Control, International Quarterly of Community Health Education, Vol. 7, Issue 1, pages 19 - 31

Bugri, Sam, (1992), (Co-chair DORN, Ghana Ministry of Health), personal communication
Cairncross, Sandy and Feachem, Richard G., (1983), Environmental Health Engineering in the Tropics - An Introductory Text, Wiley, Chichester, U.K.

Cairncross, Sandy and Feachem, Richard, (1986), Small Water Supplies, Bulletin No. 10, The Ross Institute of Tropical Hygiene, London School of Hygiene and Tropical Medicine, London, U.K.

Carter, Richard, (1985), Groundwater Development Using Jetted Boreholes, Waterlines Vol. 3, No. 3, Intermediate Technology Publications, London, U.K.

Carty, Dermot, (1990), Water-well bucket protection in Zambia, Waterlines, Vol. 8, No. 4, Intermediate Technology Publications, London, U.K., pages 26 - 28

CDC (1989), Guidelines for Chemical Control of Copepod Populations in Dracunculiasis Eradication Programmes, World Health Organisation Collaborating Center for Research, Training and Control of Dracunculiasis, Centers for Disease Control, Atlanta, Georgia, U.S.A.

CDC (1991), Guidelines for Health Education and Community Mobilization in Dracunculiasis Eradication Programs, World Health Organisation Collaborating Center for Research, Training and Control of Dracunculiasis, Centres for Disease Control, Atlanta, Georgia, U.S.A.

Chauvin J., Plopper S. and Malina A., (1992), Final Evaluation of the Benin Rural Water Supply and Sanitation Project, WASH Field Report No. 349, Water and Sanitation for Health (WASH), Washington D.C., U.S.A.

Childers, Laurie and Claasen, Fran, (1987), UNICEF's upward-flow water filter, Waterlines, Vol. 5, No. 4, Intermediate Technology Publications, London, pages 29 - 31

Consallen (1992), personal communication with, and trade literature from Consallen Group Sales Ltd., Loughton, Essex, U.K.

Cornish, Gerald A., (1987), Well Jetting in Mexico, Developing World Water, Grosvenor Press International, Hong Kong, pages 94 - 97

Davis, Colin, (1992), Hydrofracturing converts dry wells into successful wells, Issue 1, WATERfront, UNICEF, New York U.S.A., pages 24 & 23

de Rooy C., Kamfut M. and Sambile O. (1986a), An Empirical Resistivity Model for Groundwater Prospecting on Basement Rocks, UNICEF - Assisted Water and Sanitation Programme in Nigeria, Papers presented at the first annual symposium and training workshop on ground water resources in Nigeria, 23rd - 25th July 1986, UNICEF, Lagos, Nigeria

de Rooy C., (1992), Personal correspondence (information given in documentation submitted to the Water, Engineering and Development Centre (WEDC) Loughborough University of Technology, U.K., during the preparation of a Ph.D thesis)

de Vrees L., (1987), Machakos Diocese Rainwater Tank Programme, Development Office, Diocese of Machakos, Kenya, (quoted by Gould (1991))

Deveraux, Scott, (1992), (Researcher studying dismantlable connectors and other aspects of uPVC rising mains for handpumps, Consumers' Research and Testing Laboratories, Harpenden, U.K.), personal communication.

DHV, (1979), Shallow Wells (2nd edition), DHV Consulting Engineers, Amersfoort, The Netherlands

DHV (1985), Low Cost Water Supply - For Human consumption, cattle watering, small scale irrigation, Part 1: Survey and Construction of Wells, DHV Consulting Engineers, Amersfoort, The Netherlands

- Dian Desa (1985), Water Purification with Moringa seeds, *Waterlines*, Vol. 3, No. 4, Intermediate Technology Publications, London, U.K., pages 22 and 23
- Dodge C.P., Skoda J.D., Ekvall T. and Espie A., (1986), Drilling and pump replacement incentives in Uganda, *Waterlines*, Vol. 5, No. 2, pages 19 - 22
- Donaldson L., Olsson U., Anderson B. and Olushola I., (undated but believed to be 1987), An operational modality for the tripod (manual) rig, 9 pages, thought to be an unpublished report, UNICEF, Lagos, Nigeria
- Donaldson, Lloyd A., (1992), Rural water and health: the challenge to water and sanitation sector professionals, *WATERfront*, Issue 1, UNICEF, New York U.S.A., pages 2, 3, 11 and 19
- DPHE & UNICEF (1989), A Report on the Development of a Pond Sand Filter, Department of Public Health Engineering, Government of the Peoples Republic of Bangladesh, and UNICEF, Dhaka, Bangladesh
- Duke, Brian O.L., (1984), Filtering out the Guinea Worm, *World Health*, March 1984, page 29
- Edwards D., Keller K., and Yohalem D., (1984), Workshop Design for Rainwater Roof Catchment Systems - A training guide, WASH Technical Report No.27, WASH, Washington D.C., U.S.A.
- Eureka (1992), personal communication with, and trade literature from, Eureka UK Ltd, Hassocks, West Sussex, U.K.
- Feachem, Richard, (1980), Bacterial standards for drinking water quality in developing countries, *The Lancet*, August 2,
- Franceys R.W.A., (1987), Handpumps - Technical brief No. 13, *Waterlines*, Vol. 6, No. 1, Intermediate Technology Publications, London, U.K., pages 15 - 18. (also in ITP (1991))
- Franceys R.W.A., (1991), Infrastructure for Low-Income Communities, unpublished Ph.D. thesis, Loughborough University of Technology, U.K.
- Gibberd V., (1969), Introduction of Rainwater Tanks and Micro-Irrigation to Botswana, Intermediate Technology Development Group, London, U.K.
- Gould, John, (1984), Rainwater catchment systems in Botswana: present, past and future, *Waterlines*, Vol. 2, No. 4, Intermediate Technology Publications, London, U.K., pages 14 - 19
- Gould, John E., (1991), Rainwater Catchment Systems for Household Water Supply, *Environmental Sanitation Reviews*, No. 32, Environmental Sanitation Information Centre, Asian institute of Technology, Bangkok, Thailand
- Gould, John, (1992), Recent developments in rainwater catchment systems, *Waterlines*, Vol. 11, No. 1, Intermediate Technology Publications, London, U.K.
- Graham, Nigel (1988), Fabrics and Slow Sand Filters, *Developing World Water*, Grosvenor Press International, Hong Kong, pages 172 - 173
- Herbert R., (1990), Dug well vs. collector well performance, British Geological Survey (BGS) Technical Report No. WD/90/34, BGS, Keyworth, Nottinghamshire, U.K.

- Herbert R. and Rastall P., (1991), Development of Horizontal Drilling for Alluvial Aquifers of High Permeability ODA/BGS R & D Project (91/7), Final Report on Work in Zimbabwe, British Geological Survey (BGS) Technical Report WD/91/50, BGS, Keyworth, Nottinghamshire, U.K.
- Hilton, David J., (1989), Further development of the inclined coil pump, *Waterlines*, Vol. 8, No. 2, Intermediate Technology Publications, London, U.K., pages 20 - 22
- Hofkes E.H. (editor), Huisman L., Sundaresan B.B., De Azevedo Netto J.M. and Lanoix J.N., (1983), Technical Paper Series No. 18, International reference Centre for Community Water Supply and Sanitation (IRC), Wiley, Chichester, U.K.
- IDRC, CRDI & CIID (1988), Solar Water Disinfection, Proceedings of a workshop held at the Brace Research Institute, Montreal, Que., Canada, 15 - 17 August 1988
- Iles, Karen, (1989), Harvesting rainwater using a simple catchment surface, *Waterlines*, Vol. 7, No. 4, Intermediate Technology Publications, London, U.K., pages 23 - 25
- Inalsa (undated), India Mark II Deep Well Hand Pump, trade literature, inalsa, New Delhi, India
- Institute for Rural water, (1982), Constructing a Household Cistern. *Water for the World* Technical Note RWS.5.C.1, Agency for International Development, Washington D.C., U.S.A.
- IRC (1988), Handpumps - Issues and concepts in rural water supply programmes, IRC Technical Paper Series No. 25, International Water and Sanitation Centre (IRC), The Hague, The Netherlands
- IRC (1988b), Community Self-Improvements in Water Supply and Sanitation - A training and reference manual for community health workers, community development workers and other community based workers, Training Series No. 5, International Water and Sanitation Centre (IRC), The Hague, The Netherlands
- Ismail, Olushola (1992), personal communication with UNICEF Nigeria
- ITP (1991), The Worth of Water - Technical briefs on health, water and sanitation, Intermediate Technology Publications, London, U.K.
- Jackson, Brian (1992), Overseas Development Administration (ODA) Engineering Division, Personal communication
- Jahn, Samia Al Azharia, (1981), Traditional Water Purification in Tropical Developing Countries - Existing Methods and Potential Application, German agency for Technical Development (GTZ), Eschborn, Germany
- Jahn, Samia Al Azharia (1984), Traditional water clarification methods - using scientific observation to maximise efficiency, *Waterlines*, Vol. 2, No. 3, Intermediate Technology Publications, London, U.K., pages 27 and 28
- Jahn, Samia Al Azharia, (1986), Proper use of natural coagulants for rural water supplies - Research in the Sudan and a guide for new projects, GTZ, Eschborn, Germany
- Jones Charles, (1987), Investigations for a Rural Water Supply Project in Northern Nigeria, *Developing World Water*, Grosvenor Press International, Hong Kong, pages 144-145
- Joy, Derek (1983), Cleaner water from fast-flowing rivers, *Waterlines*, Vol.1 No.4, Intermediate Technology Publications, London, U.K., pages 26 -28
- Kukita, Jun, (undated), Plastic Lined Rain-Water Catchment System, unpublished memo, UNICEF, Windhoek, Namibia
- Lambert, Robert, (1989), How to Make a Rope and Washer Pump, Intermediate Technology Publications, London, U.K.
- Lambert R.A., (1992) the need for and design of a pressurised discharge human-powered treadle pump. Proceedings of the Institution of Civil Engineers (ICE), Vol. 92, Issue 2, ICE, London, U.K., pages 66 - 73

Larsson, Robert W., (1992), Strategies for the Eradication of *Dracunculus medinensis* from Africa, unpublished paper (presented as qualification from the M.Phil. into the Ph.D programme at the Water, Engineering and Development Centre, Loughborough university of Technology, U.K.)

Latham, Brian, (1984), Building the Thai jumbo water jar using a brick form, *Waterlines*, Vol. 3, No. 2, Intermediate Technology Publications, London, pages 26 - 28

Laver, Sue, (1987), Well Sinking - a step by step guide to the construction of wells using the blasting method, UNICEF, Harare, Zimbabwe

Lee M.D. and Visscher J.T., (1990), Water Harvesting in Five African Countries, International Water and Sanitation Centre (IRC), The Hague, The Netherlands

LSHTM and Gifford (1986), Evaluation of SWS Filtration System, Overseas Development Administration Project No. R3957, London School of Hygiene and Tropical Medicine, London and Gifford and Partners, Southampton, U.K.

Maddocks D., (1975), Methods for creating low cost membranes for use in the construction of rainwater catchment and storage systems, Intermediate Technology Publications, London, U.K.

McPherson H.J., Livingstone A., Mohamed Y.A. and Liao M., (1989), Sustainable Operations and Maintenance of Rural Water Supplies in Sudan, Community water Supply and Sanitation WHO/CWS/89.19

Metianu, Andrew, (1982), A simple method of jetting tubewells, *Waterlines* Vol. 1, No. 1, Intermediate Technology Publications, London, U.K., pages 6-8

MHCE (undated), Land and Water Resources of Africa - A Teachers' Guide, Moray House College of Education, Edinburgh, U.K.

Morgan, Peter, (1990), Rural Water Supplies and Sanitation, Macmillan, London, U.K.

Morgan, Peter and Chimbunde Ephraim, (1991), Upgrading family wells in Zimbabwe, *Waterlines*, Vol. 9, No. 3, Intermediate Technology Publications, London, U.K., pages 10 - 12

Mudgal A.K., (1992), (Technology Specialist, UNDP/World Bank Water and Sanitation Programme, New Delhi, India), personal communication

Muller R., (1970), Laboratory experiments on the control of Cyclops transmitting Guinea worm, Bulletin No. 42, World Health Organisation (WHO), Geneva, Switzerland, pages 563 - 567 (quoted in CDC (1989))

Muller R. (1972), Maintenance of *Dracunculus medinensis* in the laboratory and observations on experimental infections, *Parasitology* No. 64, pages 107 - 116, quoted in Muller (1985)

Muller, Ralph L.J., (1985), The Biology of Cyclops in Relation to Guineaworm Transmission and Control, in *Dracunculiasis in Nigeria*, Conference Proceedings March 25th - 27th 1985, Federal Ministry of Health, Ikoyi, Lagos, Nigeria, pages 22 - 29

- MWEDM, CIDA & SIDA (1979), Rural Water Quality in Tanzania, Ministry of Water Development Energy and Minerals, CIDA and SIDA, (quoted by Jahn 1981)
- Naugle, Jonathan, (1992), Affordable water for irrigation: An experience in Niger, *Waterlines* Vol. 11, No. 1, Intermediate Technology Publications, London, U.K., pages 28 - 31
- Nilsson, Ake, (1988), Groundwater Dams for Small Scale Water Supply, Intermediate Technology Publications, London, U.K.
- Nissen-Petersen E., (1990), Harvesting rainwater in Semi-Arid Africa, Manual No. 2, Small Earth Dam Built by Animal Traction, ASAL Rainwater Harvesting Nairobi, Kenya
- Nissen-Petersen E. and Lee M., (1990a), Harvesting Rainwater in Semi-Arid Africa, Manual No. 1, Water Tanks with Guttering and Handpump, ASAL Rainwater Harvesting Nairobi, Kenya
- Nissen-Petersen E. and Lee M., (1990b), Harvesting, Rainwater in Semi-Arid Africa, Manual No.5, Sub- Surface and Sand-Storage Dams, ASAL Rainwater Harvesting, Nairobi, Kenya
- O'Brien, Louis, (1990a), Report on RWH Project in Togo, *Raindrop Rainwater Harvesting Bulletin*, Vol. 3, Water and Sanitation for Health Project (WASH), Arlington, Virginia, U.S.A, pages 1,5 and 6
- O'Brien, Lois, (1990b), Local Networking in Kara, Togo, *Raindrop Rainwater Harvesting Bulletin*, Vol. 3, Water and Sanitation for Health Project (WASH), Arlington, Virginia, U.S.A, page 7
- ODA (1989), Performance of Fabric Protected Slow Sand Filters Treating Poor Quality River Water, Final Report to the ODA Project R4373, Overseas Development Administration (ODA), London, U.K.
- Ongweny G.S., (1979), Rainfall and stormwater harvesting for additional water supplies in Africa - Report to UNEP, Nairobi, Kenya (quoted by Lee and Visscher (1990))
- OXFAM (undated), OXFAM Water Supply Scheme for Refugee Camps - Treatment Package, OXFAM, Oxford, U.K.
- Pacey A. and Cullis A., (1986), Rainwater Harvesting - The collection of rainfall and runoff in rural areas, Intermediate Technology Publications, London, U.K.
- Parry (1991), trade literature of J.M.P. Parry & Associates Ltd., Cradley Heath, U.K.
- Philippeaux H. and Sassarao P.R.G., (1992), Rainwater Harvesting in Burundi, *WATERfront*, Issue 2, Water and Environmental Sanitation Section, UNICEF, New York, U.K.
- PMI (1992), Trade literature about the UPM pump, manufactured by Pompes Maupu International, Orleans, France
- Pontin J.M.A. and Woolridge R. (1977), A Study of Hafir Linings in Dafur Province, Western Sudan, Report OD/10, Hydraulics Research Station, Wallingford, U.K.
- Potapak (1992), Trade literature of, and personal communication with, Potapak Ltd., Newbury, Berkshire, U.K.
- Prins, Agma and Yacob, May (1988), Adding Guinea Worm Control Components: Guidelines for Water and Sanitation Projects, WASH Technical Report No. 51, Water and Sanitation for Health (WASH), Washington, U.S.A.
- Rajagopalan S. and Shiffman M.A., (1974), Guide to Simple Sanitary Measures for the Control of Enteric Diseases, World Health Organisation, Geneva
- Roark P., Kittle B., Yango J., Nignan D., Yonli R., Tindano R. and Gnoumou M., Final Evaluation USAID/Burkina Faso Rural Water Supply Project. WASH Field Report No. 191, Water and Sanitation for Health (WASH), Washington, D.C., USA
- Rous, Tim, (1985), Protecting a shallow seepage spring, *Waterlines*, Vol. 4, No. 2, Intermediate Technology Publications, London U.K., pages 23 - 25

Silverfine E., Brieger W. and Churchill A., (1991), *Community-based initiatives to Eradicate Guinea worm - A manual for Peace Corps Volunteers, Vector Biology and Control Project, USAID, U.S.A.*

Singh, Vinay Pratap and Chaudhuri, Malay (1992), *Performance Evaluation and Operational Modification of the UNICEF Upward Flow Water Filter, a paper presented at the First Middle East Conference on Water Supply and Sanitation in Rural Areas, Cairo, Egypt, 23-25 Feb., 1992*

Skinner, Brian, (1992), *Protecting Springs: An alternative to Spring Boxes, Technical Brief No.34, Waterlines, Vol. 11, No. 2, Intermediate Technology Publications, London, U.K., pages 15 - 19*

Skinner B. and Cotton A., *Community Rainwater Catchment, (an as yet unpublished manual, completed 1992), International Labour Organisation, Geneva, Switzerland*

Smet J.E.M. and Visscher J.T. (compilers), (1990), *Pre- Treatment Methods for Community Water Supply, IRC International Water and Sanitation Centre, The Hague, The Netherlands*

Smet J.E.M. and Wheeler D., (1990), *Modular Sub-Sand Abstraction Systems, in Smet and Visscher (1990), pages 39 - 51*

Smith, Michael, (1988), *Sludging - Hand Jetting of Tubewells, Developing World Water, Grosvenor Press International, Hong Kong, pages 91 and 92*

Smith, Michael, (1990), *Groundwater Dams, Technical Brief No. 24, Waterlines, Vol.8, No. 4, Intermediate Technology Publications, London, U.K., pages 15 - 18. (also ITP (1991))*

Sridhar M.K.C., Kale O.O. and Adeniyi J.D., (1985), *A simple sand filter to reduce Guinea worm disease in Nigeria, Waterlines, Vol. 4, No. 2, Intermediate Technology Publications, London, U.K., pages 16 - 19*

Sutherland J.P., Folkard G.K. and Grant W.D., *Natural coagulants for appropriate water treatment: a novel approach, Waterlines, Vol. 8,*

No. 4, Intermediate Technology Publications, London, U.K.

SWS (1992), *personal communication with, and trade literature from SWS Filtration Ltd, Morpeth, Northumberland, U.K.*

UNICEF (undated), *Cement jars for the storage of grain and water, UNICEF/Ministry of Housing and Social Services Village Technology Unit, Nairobi, Kenya*

UNICEF (1986), *Ground catchment ferroceement water tank, Waterlines, Vol. 5, No. 2, Intermediate Technology Publications, London, U.K., pages 28 - 30*

UNICEF (1992), *Strategies & Resources - Operational Strategy Framework for Dracunculiasis Eradication, Version 1.1,*

UNICEF, New York, U.S.A.

Visscher J.T., Paramasivam R., Raman A. and Heijnen H.A., (1987), *Slow Sand Filtration for Community Water Supply - Planning, design, construction, operation and maintenance, Technical Paper No. 24, International Reference Centre for Community Water Supply and sanitation, The Hague, The Netherlands*

V & W Engineering (1992), *Costs and trade literature from manufacturers V. & W. Engineering & Installations (Pvt.) Ltd., Harare, Zimbabwe; information obtained from WaterAid (1992)*

Wagner E.G. and Lanoix J.N. (1959), *Water Supply for Rural Areas and Small Communities, WHO Monograph Series, No 42, World Health Organisation, Geneva*

WaterAid (1992), *personal discussions with WaterAid staff, London, U.K.*

Watt, S.B. and Wood, W.E., (1976), *Hand Dug Wells and their Construction, Intermediate Technology Publications, London, U.K.*

Watt, S.B., (1978), *Ferroceement water tanks and their construction, Intermediate Technology Publications, London, U.K.*

WES, (1992), *Low-cost, high impact approaches in Sudan, Water and Environmental Sanitation*

(WES) Section, WATERfront, Issue 1, UNICEF, New York, U.S.A., pages 18 and 19
Wheeler D., Skilton H., Pardon M. and Lloyd B., (1986), The enhancement of slow rate sand filters by the incorporation of synthetic fabrics, ODA Research Project R3760 at the University of Surrey U.K., Del Agua, Guildford, U.K.

WHO, DPHE & UNICEF (1991), Report on Study of Pond Sand Filters, WHO, DPHE and UNICEF, Dhaka, Bangladesh
Winter, Stephen J., (1987), A ferrocement well for Micronesia, Waterlines Vol. 6, No. 2, Intermediate Technology Publishing, London, U.K., pages 20 - 22

Wirojanagud W. and Hovichitr V. et al., (1989), Evaluation of Rainwater Quality: Heavy metals and Pathogens, IDRC, Ottawa, Canada. (quoted by Gould (1991))

Wirojanagud P., (1991), (Associate professor at Water Resources and Environment Institute, Khon Kaen University, Thailand), personal communication

Wiseman, Robin, (1983), Kano's Jet Set, World Water, issue of October 1983, Liverpool, U.K.
World Water (1979), Well-sinking made easy in Bangladesh's ideal terrain, World Water, Issue of December 1979, Liverpool, U.K.,

WRC (1975), The effects of storage on water quality, Papers and proceedings at a Water Research Symposium, 24-26 March, Water Research Centre (WRC), Buckinghamshire, U.K.

Wright E.P. and Herbert R., (1985), Collector Wells in Basement Aquifers, Waterlines, Vol. 4, No 2, Intermediate Technology Publications, London, U.K., pages 8 - 11

Wurzel, Peter, (1992), Concept versus Reality: The Afridev Handpump, WATERfront, Issue 2, Water and Environmental Sanitation Section, UNICEF, New York, U.S.A., pages 8 and 9

Yaziz, Mohammad Ismail and Din, Omar, (1988), Portable slow sand filter, paper in proceedings of 14th WEDC Conference, Water and Urban Services in Asia and the Pacific, Kuala Lumpur; Water, Engineering and

Development Centre (WEDC), Loughborough University of Technology, U.K., pages 19 - 22

APPENDIX I

Terms of Reference

TERMS OF REFERENCE

RESEARCH INTO COST EFFECTIVE TECHNOLOGIES FOR WATER SUPPLY IN GUINEA WORM ENDEMIC AREAS

1. BACKGROUND

The eradication of Dracunculiasis by the year 2000 is the target set by the United Nations and other National and International agencies. The goal to eradicate guinea worm was initially endorsed in April 1981 by the Steering Committee of the International Drinking Water Supply and Sanitation Decade. In 1989, the UNICEF Executive Board (E/ICEF/1989/CRP.2 dated 22 March 1989) supported the elimination of guinea worm as *'A disease that can be eliminated by providing safe drinking water and health education using already existing cost-effective measures'*. The eradication of guinea worm is also one of the goals of the World Summit of Children declared in September 1991.

Dracunculiasis is the only disease that can be eradicated completely by the provision of improved water supplies provided that these are used at all times. As outlined in the forty first World Health Assembly (A41/INF.DOC./2 dated 13 April 1988) in their review of progress in the elimination of guinea worm:

'Priority should be given to improving drinking water sources in villages where dracunculiasis is endemic because (a) those villages suffer from dracunculiasis in addition to all other problems befalling villages without safe drinking water; (b) they constitute only a small fraction of all unserved villages in endemic countries; and (c) the obvious success achieved in such villages can help to increase and sustain support for the water supply programme as a whole in affected countries'

However efforts need to be made to investigate alternative low cost technologies that can be used for isolated communities and areas with difficult hydrogeological conditions in order to reduce per capita costs which should not exceed US\$30 per capita (low cost rural water supply systems at present average US\$20 per capita in Africa). These technologies have to be easily replicated on a large scale and, if eradication is to be achieved this decade, appropriate low cost water supply services have to be provided as quickly as possible.

Obviously in many cases a handpump-equipped borehole may be the most suitable technical option. However the cost escalates rapidly in isolated communities with populations under 200 persons and where the hydrogeological conditions are unsuitable i.e. ground water level beyond recommended 50 metres depth and/or

aquifer is not easily accessible. UNICEF and other agencies have been actively involved in investigating alternative technologies that can be used in Africa. These have included rainwater harvesting, solar powered systems and promotion of household water filters. However there is a need for suitable guidelines to be developed outlining the introduction of suitable low cost technologies in guinea worm endemic countries on a large scale. A project proposal needs to be formulated recommending suitable improvements that could be undertaken to make these technologies more technically, socially and economically effective.

2. OVERALL PURPOSE

To investigate and propose low cost effective methods to provide clean drinking water to guinea worm endemic areas. The results of the findings will be used to develop suitable projects in a selected number of guinea worm endemic countries.

3. SPECIFIC OBJECTIVES

3.1 BACKGROUND PAPER

Collect relevant information from suitable sources including a literature review, interviews with suitable persons/agencies/private companies regarding appropriate technologies, including those listed below. The consultant will document which technologies have been proven to work and those that need to be further tested. Some technologies are listed below. However the consultant is recommended to include others as he considers advisable.

3.1.1 Rainwater Harvesting

UNICEF recently funded a study 'Water Harvesting in Five African Countries'¹ which investigated appropriate rainwater harvesting technologies in countries including Mali and Togo. Presently most systems have been based on rooftop catchment systems. However surface catchment systems can be very suitable for provision of sufficient drinking water (4-5 litres/person/day) when combined with other sources for domestic purposes. According to the UNICEF report, rainwater harvesting has potential for wider expansion when the rainfall is between 200-1000 mm per annum. The study also recommends that for drinking water supplies, surface catchment systems should be widely applied in the sub-humid and semi-arid areas and rooftop catchment systems in the humid and sub-humid areas. These findings need to be further investigated with respect to cost effectiveness of household

¹ Lee, M.D. and Visscher J. T. (1990). Water Harvesting in Five African Countries. IRC International Water and Sanitation Centre. The Hague, The Netherlands.

versus community systems and compared with previous and more recent findings.

3.1.2 Solar Powered Systems

Many West African countries have been involved in installing solar powered water supply systems. However these have mainly been for larger communities at a per capita cost between US\$40-80. Many large companies have been involved in their manufacture. GRUNDFOS have been involved in installing systems in Mali, the Gambia and Senegal using French manufactured photovoltaic cells.

UNICEF and other agencies have much information of small entrepreneurs who are manufacturing solar pumps at lower cost. These need to be reviewed and suitable meetings conducted to investigate their applicability for guinea worm endemic areas.

3.1.3 Slow Sand Filtration

This can be a simple, efficient and reliable technique for the treatment of water. Its cost usually lies within the resources of communities who can be actively involved in the construction, operation and maintenance. Various countries have tested these systems and the International Reference Centre (IRC), the Hague, have supported a number of research projects. However major problems have arisen in the operation and maintenance of these systems which require regular maintenance in order to periodically remove the top of the filter bed. If the water is too turbid the system is not suitable.

It is recommended that the consultant should liaise with IRC to follow up the findings of the IRC 1982 report² and document successful and unsuccessful case studies analysing these for future technical research, if found necessary.

3.1.4 Infiltration Galleries

With suitable bed conditions, water can be extracted from rivers by digging tunnels parallel or constructing wells alongside the river. To some extent water is filtered by passing through the bed material. Little information is presently available regarding successful projects. A review should be made of all relevant literature and discussions held with agencies that have been involved in supporting this technology.

² Slow Sand Filtration of Community Water Supply in Developing Countries, IRC International Reference Centre for Community Water Supply and Sanitation, September 1982.

3.1.5 Clay Pot Filters

In many guinea worm endemic countries clay pot filters are presently used. However it would be useful to review the designs presently used with respect to capacity, shape and ability to keep clean. Most are used with mesh filters usually provided by government.

The use of community versus household water filters needs to be further investigated.

3.1.6 Chemical Treatment

This can be an expensive and difficult method to maintain at the community level. However various private companies are now manufacturing more cost effective and innovative methods to disinfect water. It may be the most cost effective method for areas where literacy rates are higher and all other methods of water provision are too expensive.

3.2 DEVELOPMENT OF GUIDELINES

- 3.2.1 Liaise with leading agencies involved in guinea worm eradication including Global 2000, Vector Biology Control, USAID, Peace Corps, CDC and others, in order to collect relevant information, exchange ideas and ensure agreement on major research findings prior to the official meeting described in Section 3.4.
- 3.2.2 Prepare a suitable background conference paper including the results of the technical review.
- 3.2.3 Work with UNICEF and collaborative agencies to convene a meeting at a suitable venue to be attended by all relevant agencies in order to share the findings of the background paper and incorporate the conclusions into the final report.

3.3 DEVELOPMENT OF PROJECT PROPOSAL

Develop a project proposal for follow up action to field test the different technical options on a large scale in selected countries including detailed methodology and cost estimates.

4. METHODOLOGY

Interviews will be conducted with UNICEF, Global 2000, CDC and other international agencies and private companies either personally or by telephone. A literature review will be undertaken of documentation pertaining to appropriate technical options including those listed in Section 3.1.

The consultant will liaise frequently with the agencies quoted in section 3.2 in order to share information. He will visit the International Reference Centre, The Hague, in order to collect relevant information. He will assist in making the necessary arrangements for the meeting to be convened. Travel and DSA for this trip will be provided by UNICEF. Consulting fee is inclusive within the contract. This should be conducted during the sixth week of the consultancy in order to allow time to assimilate the conclusions into the final report.

5. FINAL PRODUCTS/OUTPUTS

5.1 A final report of approximately 25-30 pages with illustrations will be produced by the Consultant at the completion of the consultancy. This will be submitted with the Project Proposal outlined in Section 3.3 to the UNICEF New York office for comments and approval.

5.2 Participate in the Technical Support Team meeting for Dracunculiasis, 24-28 August in Annecy, France to review and discuss development of guidelines with TST members, UNICEF field officers and agency partners.

Travel and DSA for this trip will be provided by UNICEF. Consulting fee is inclusive within the contract.

5.3 An advanced draft should be submitted in October to serve as a background document for an interagency meeting on this topic. Consultant should participate in this consultative meeting in New York with UNICEF and collaborating agencies, October 1992.

Travel and DSA will be provided by UNICEF. Consulting fee is inclusive within the contract.

5.4 A final draft should be submitted early November 1992 to incorporate comments and suggestions from the interagency consultation.

6. DURATION

The consultancy will be for a duration of seven weeks.